

Space Details

Key:	GROOVY
Name:	Groovy
Description:	Documentation and web site of the Groovy scripting language for the JVM.
Creator (Creation Date):	bob (Apr 15, 2004)
Last Modifier (Mod. Date):	glaforge (Apr 12, 2005)

Available Pages

- Advanced Usage Guide
 - Ant Task Troubleshooting
 - BuilderSupport
 - Compiling Groovy
 - Compiling With Maven2
 - Design Patterns with Groovy
 - Abstract Factory Pattern
 - Adapter Pattern
 - Bouncer Pattern
 - Chain of Responsibility Pattern
 - Composite Pattern
 - Decorator Pattern
 - Delegation Pattern
 - Flyweight Pattern
 - Iterator Pattern
 - Loan my Resource Pattern
 - Null Object Pattern
 - Pimp my Library Pattern
 - Proxy Pattern
 - Singleton Pattern
 - State Pattern
 - Strategy Pattern
 - Template Method Pattern
 - Visitor Pattern
 - Dynamic language beans in Spring
 - Embedding Groovy
 - Influencing class loading at runtime
 - Internationalization
 - Make a builder
 - Mixed Java and Groovy Applications
 - Optimising Groovy bytecodes with Soot
 - Polyglot Programming with Groovy
 - Constraint Programming
 - Functional Programming

- JSR-223 access to other JVM languages
- Refactoring with Groovy
 - Introduce Assertion
 - Replace Inheritance with Delegation
- Security
- Writing Domain-Specific Languages
- Articles
- Community and Support
 - Contributing
 - Forums and Newsgroups
 - Mailing Lists
 - Related Projects
 - User Groups
- Cookbook Examples
 - Accessing SQLServer using groovy
 - Alternate Spring-Groovy-Integration
 - Auto setup and download dependencies jars
 - Batch Image Manipulation
 - command line groovy doc or methods lookup
 - Compute distance from Google Earth Path (in .kml file)
 - Convert SQL Result To XML
 - Embedded Derby DB examples
 - Embedding a Groovy Console in a Java Server Application
 - Executing External Processes From Groovy
 - Formatting simple tabular text data
 - Groovy Alternatives to Inner Classes
 - Installing or Update Groovy Automatically
 - InstallTextMateGroovyBundle
 - Integrating Groovy in an application - a success story
 - Iterator Tricks
 - Martin Fowler's closure examples in Groovy
 - Other Examples
 - Parsing Groovy Doc Online
 - Plotting graphs with JFreeChart
 - PoorMansMixins
 - Reading from a Blob
 - Recipes For File
 - Search one or more jar files for a text string
 - Simple file download from URL
 - Solving Sudoku
 - SwingBuilder with custom widgets and observer pattern
 - Tomcat tools

- Unsign Jar Files (Recursively)
- Using JGoodies Animation with Groovy
- Using JScience with Groovy
- Using MarkupBuilder for Agile XML creation
- Using the Delegating Meta Class
- Using the Eclipse Modeling Framework (EMF)
- Using the Eclipse UML2 Framework
- Using the Proxy Meta Class
- Windows Look And Feel for groovyConsole
- WrappingGroovyScript
- Writing to a Blob
- Yaml and Groovy
- Developer Guide
 - Building Groovy from Source
 - Continuous Integration
 - From source code to bytecode
 - Groovy Backstage
 - Groovy Method Invokation
 - Groovy Internals
 - Ivy
 - Release Process
 - Setup Groovy Development Environment
- FAQ
 - Class Loading
 - FAQ - Classes and Object Orientation
 - FAQ - Closures
 - FAQ - Collections, Lists, etc.
 - FAQ - GSQL
 - FAQ - RegExp
 - General
 - How can I edit the documentation
 - Language questions
 - Can I break a Groovy statement into multiple lines anyway I want?
 - How can I dynamically add a library to the classpath
 - Why does == differ from Java
 - Learning about Groovy FAQ
 - Runtime vs Compile time, Static vs Dynamic
- Getting Started Guide
 - Beginners Tutorial
 - Tutorial 1 - Getting started
 - Tutorial 2 - Code as data, or closures
 - Tutorial 3 - Classes and Objects
 - Tutorial 4 - Regular expressions basics

- Tutorial 5 - Capturing regex groups
 - Tutorial 6 - Groovy SQL
- Differences to Other Languages
 - Differences from Java
 - Differences from Python
 - Differences from Ruby
- Download
- Feature Overview
 - Groovlets
 - Groovy Beans
 - Groovy Templates
 - GroovyMarkup
- For those new to both Java and Groovy
 - JN0025-Starting
 - JN0515-Integers
 - JN0525-Decimals
 - JN0535-Floats
 - JN0545-Dates
 - JN1015-Collections
 - JN1025-Arrays
 - JN1035-Maps
 - JN1515-Characters
 - JN1525-Strings
 - JN1535-Patterns
 - JN2015-Files
 - JN2025-Streams
 - JN2515-Closures
 - JN2525-Classes
 - JN2535-Control
 - JN3015-Types
 - JN3025-Inheritance
 - JN3035-Exceptions
 - JN3515-Interception
 - JN3525-MetaClasses
 - JN3535-Reflection
- Groovy for the Office
- Groovy Quick Start Project
- Quick Start
 - Installing Groovy
 - Installing Groovy and Grails on the Eee PC
 - Running
- GroovyArticles

- IDE Support
 - Debugging with JSwat
 - Eclipse Plugin
 - Debugging with Eclipse
 - Eclipse GroovyConsole
 - Eclipse Plugin Development
 - Code Completion Proposal
 - GroovyEclipse Specifications and Technical Articles
 - The Classloader Conundrum
 - GroovyEclipse Wish List
 - Eclipse Plugin FAQ
 - Grails Development Support
 - Grails Eclipse Feature
 - New Grails Project Wizard
 - IntelliJ IDEA Plugin
 - GroovyJ Features and Wish List
 - GroovyJ Status
 - IDEA Open API
 - IntelliJ IDEA Plugin (JetBrains Edition)
 - Wish List (JetBrains Edition)
 - JEdit Plugin
 - NetBeans Plugin
 - Oracle JDeveloper Plugin
 - Other Plugins
 - Emacs Plugin
 - UltraEdit Plugin
 - TextMate
- Modules
 - COM Scripting
 - All About Arrays
 - Change Log
 - COM Data Types in Scriptom
 - COM Events
 - COM Methods and Properties in Scriptom
 - Passing Values by Reference (in-out)
 - Scriptom Archive
 - Copy of COM Scripting
 - Scriptom 1.2
 - Scriptom Articles
 - Bridging the Gap Between Java and .NET with Groovy and Scriptom
 - Getting Started with COM
 - Using Scriptom to Automate Microsoft Excel
 - The Least You Need to Know about COM
 - Gant

- GFreeMarker
- Google Data Support
- Gram
- GraphicsBuilder
 - GraphicsBuilder - Animation
 - GraphicsBuilder - Animation - Bind
 - GraphicsBuilder - GDK
 - GraphicsBuilder - Groodles
 - GraphicsBuilder - Groodle1 - Screencast
 - GraphicsBuilder - Groodle2 - Screencast
 - GraphicsBuilder - Groodle3 - Screencast
 - GraphicsBuilder - Groups
 - GraphicsBuilder - Misc
 - GraphicsBuilder - Misc - Antialias
 - GraphicsBuilder - Misc - Clip
 - GraphicsBuilder - Misc - Color
 - GraphicsBuilder - Misc - Draw
 - GraphicsBuilder - Misc - Font
 - GraphicsBuilder - Misc - Image
 - GraphicsBuilder - Misc - RenderingHint
 - GraphicsBuilder - Outlines
 - GraphicsBuilder - Outlines - CubicCurve
 - GraphicsBuilder - Outlines - Line
 - GraphicsBuilder - Outlines - Polyline
 - GraphicsBuilder - Outlines - QuadCurve
 - GraphicsBuilder - Paints
 - GraphicsBuilder - Paints - BorderPaint
 - GraphicsBuilder - Paints - ColorPaint
 - GraphicsBuilder - Paints - GradientPaint
 - GraphicsBuilder - Paints - LinearGradient
 - GraphicsBuilder - Paints - MultiPaint
 - GraphicsBuilder - Paints - Paint
 - GraphicsBuilder - Paints - RadialGradient
 - GraphicsBuilder - Paints - TexturePaint
 - GraphicsBuilder - Shapes
 - GraphicsBuilder - Area - Add
 - GraphicsBuilder - Area - Intersect
 - GraphicsBuilder - Area - Shape
 - GraphicsBuilder - Area - Subtract
 - GraphicsBuilder - Area - Xor
 - GraphicsBuilder - Shapes - Arc
 - GraphicsBuilder - Shapes - Arrow
 - GraphicsBuilder - Shapes - Circle

- GraphicsBuilder - Shapes - Cross
- GraphicsBuilder - Shapes - Donut
- GraphicsBuilder - Shapes - Ellipse
- GraphicsBuilder - Shapes - Morph
- GraphicsBuilder - Shapes - Path
- GraphicsBuilder - Shapes - Pin
- GraphicsBuilder - Shapes - Polygon
- GraphicsBuilder - Shapes - Rays
- GraphicsBuilder - Shapes - Rect
- GraphicsBuilder - Shapes - RegularPolygon
- GraphicsBuilder - Shapes - RoundRect
- GraphicsBuilder - Shapes - Star
- GraphicsBuilder - Shapes - Text
- GraphicsBuilder - Shapes - Triangle
- GraphicsBuilder - Shapes - Xpath
- GraphicsBuilder - Strokes
 - GraphicsBuilder - Strokes - BasicStroke
 - GraphicsBuilder - Strokes - CompositeStroke
 - GraphicsBuilder - Strokes - CompoundStroke
 - GraphicsBuilder - Strokes - Shapetroke
 - GraphicsBuilder - Strokes - Stroke
 - GraphicsBuilder - Strokes - TextStroke
 - GraphicsBuilder - Strokes - WobbleStroke
 - GraphicsBuilder - Strokes - ZigzagStroke
- Graphicsbuilder - SVG
- GraphicsBuilder - Swing
- GraphicsBuilder - Transformations
- Grapplet
- Griffon
 - UberBuilder
- Groosh
- Groovy Jabber-RPC
- Groovy Monkey
- Groovy SOAP
- GroovyLab
- GroovyRestlet
 - GroovyRestlet User Guide
 - RestletTutorialExamples
 - SpringIntegrationExamples
- GroovySWT
 - A sample application
 - groovy-swt - Comparing the java and the groovy code

- GroovyWS
- GSP
- GSQL
- JideBuilder
- Native Launcher
- Windows NSIS-Installer
- Windows Services
- WingSBuilder
- XMLRPC
- News and Further Information
 - Books
 - Groovy Series
 - PLEAC Examples
- Roadmap, Discussions and Proposals
 - Discussions
 - Feature Wish List
 - First impressions
 - Groovy.Net module discussion
 - J2ME and Groovy
 - New Groovy Console Wish List
 - Proposals
 - Annotation usage with properties
 - AST Macros and Annotations
 - C Sharp Groovinator
 - GJIT - Groovy Just-In-Time Compiler
 - Grapes and grab()
 - Groovy realtime archive internet lookup
 - JSR-295 Binding Builder
 - Macro Use Cases
 - MetaClass Redesign (by blackdrag)
 - MetaClass Redesign (by blackdrag) part 2
 - MOP 2.0 ideas
 - Multiple Assignment Proposal
 - Multiproject builds
 - Proposed Website Revamp
 - Roadmap
 - Not Yet Documented
 - Gldapwrap - Usage
 - Sources and tests reorganization and distribution
- Testing Guide
 - Groovy Mocks
 - Developer Testing using Closures instead of Mocks
 - Developer Testing using Maps and Expandos instead of Mocks

- Mocking Static Methods using Groovy
 - Using MockFor and StubFor
- Integrating TPTP
- Model-based testing using ModelJUnit
- Test Combinations
 - Effectiveness of testing combinations with all pairs
- Test Coverage
 - Code Coverage with Cobertura
- Testing Web Applications
- Testing Web Services
- Unit Testing
 - Using JUnit 4 with Groovy
- Using Other Testing Frameworks
 - Using EasyMock with Groovy
 - Using Instinct with Groovy
 - Using JBehave with Groovy
 - Using JDummy with Groovy
 - Using JMock with Groovy
 - Using JMockit with Groovy
 - Using Popper with Groovy
 - Using RMock with Groovy
 - Using TestNG with Groovy
- Using Testing Frameworks with Groovy
 - Using GSpec with Groovy
- User Guide
 - Advanced OO
 - Groovy way to implement interfaces
 - Annotations with Groovy
 - Ant Integration with Groovy
 - The groovy Ant Task
 - The groovyc Ant Task
 - Using Ant from Groovy
 - Using Ant Libraries with AntBuilder
 - Bean Scripting Framework
 - Bitwise Operations
 - Builders
 - FactoryBuilderSupport
 - Closures
 - Closures - Formal Definition
 - Closures - Informal Guide
 - Collections
 - Control Structures
 - Logical Branching

- Looping
- Database features
- Dynamic Groovy
 - Evaluating the MetaClass runtime
 - ExpandoMetaClass
 - ExpandoMetaClass - Borrowing Methods
 - ExpandoMetaClass - Constructors
 - ExpandoMetaClass - Dynamic Method Names
 - ExpandoMetaClass - GroovyObject Methods
 - ExpandoMetaClass - Interfaces
 - ExpandoMetaClass - Methods
 - ExpandoMetaClass - Overriding static invokeMethod
 - ExpandoMetaClass - Properties
 - ExpandoMetaClass - Runtime Discovery
 - ExpandoMetaClass - Static Methods
 - Per-Instance MetaClass
 - Using invokeMethod and getProperty
 - Using methodMissing and propertyMissing
- GDK Extensions to Object
- Generics
- GMaven
 - GMaven - Advanced Configuration
 - GMaven - Building Groovy Projects
 - GMaven - Executing Groovy Code
 - GMaven - Groovy Runtime
 - GMaven - Implementing Maven Plugins
 - GMaven - Releases
 - GMaven - 1.0-beta-4 Release
 - GMaven - Running Groovy Tools
- GPath
- Groovy and JMX
- Groovy Categories
- Groovy CLI
- Groovy Console
- Groovy Math
- Groovy Maven Plugin
- Groovy Shell
- Groovy Truth
- Groovy Utils
 - ConfigSlurper
 - ObjectGraphBuilder
 - ObservableMap

- GUI Programming with Groovy
 - Swing Builder
 - Alphabetical Widgets List
 - SwingBuidler.borderLayout
 - SwingBuilder.action
 - SwingBuilder.actions
 - SwingBuilder.bind
 - SwingBuilder.borderLayout
 - SwingBuilder.boundedRangeModel
 - SwingBuilder.box
 - SwingBuilder.boxLayout
 - SwingBuilder.button
 - SwingBuilder.buttonGroup
 - SwingBuilder.cardLayout
 - SwingBuilder.checkBox
 - SwingBuilder.checkBoxMenuItem
 - SwingBuilder.closureColumn
 - SwingBuilder.colorChooser
 - SwingBuilder.comboBox
 - SwingBuilder.compoundBorder
 - SwingBuilder.container
 - SwingBuilder.desktopPane
 - SwingBuilder.dialog
 - SwingBuilder.editorPane
 - SwingBuilder.emptyBorder
 - SwingBuilder.etchedBorder
 - SwingBuilder.fileChooser
 - SwingBuilder.flowLayout
 - SwingBuilder.formattedTextField
 - SwingBuilder.frame
 - SwingBuilder.gridBagConstraints
 - SwingBuilder.gridBagLayout
 - SwingBuilder.gridLayout
 - SwingBuilder.imageIcon
 - SwingBuilder.internalFrame
 - SwingBuilder.JComponent
 - SwingBuilder.label
 - SwingBuilder.layeredPane
 - SwingBuilder.lineBorder
 - SwingBuilder.list
 - SwingBuilder.loweredBevelBorder
 - SwingBuilder.map

- SwingBuilder.matteBorder
- SwingBuilder.menu
- SwingBuilder.menuBar
- SwingBuilder.menuItem
- SwingBuilder.optionPane
- SwingBuilder.overlayLayout
- SwingBuilder.panel
- SwingBuilder.passwordField
- SwingBuilder.popupMenu
- SwingBuilder.progressBar
- SwingBuilder.propertyColumn
- SwingBuilder.radioButton
- SwingBuilder.radioButtonMenuItem
- SwingBuilder.raisedBevelBorder
- SwingBuilder.raisedEtchedBorder
- SwingBuilder.scrollBar
- SwingBuilder.scrollPane
- SwingBuilder.separator
- SwingBuilder.slider
- SwingBuilder.spinner
- SwingBuilder.spinnerDateModel
- SwingBuilder.spinnerListModel
- SwingBuilder.spinnerNumberModel
- SwingBuilder.splitPane
- SwingBuilder.springLayout
- SwingBuilder.tabbedPane
- SwingBuilder.table
- SwingBuilder.tableColumn
- SwingBuilder.tableLayout
- SwingBuilder.tableModel
- SwingBuilder.td
- SwingBuilder.textArea
- SwingBuilder.textField
- SwingBuilder.textPane
- SwingBuilder.titledBorder
- SwingBuilder.toggleButton
- SwingBuilder.toolBar
- SwingBuilder.tr
- SwingBuilder.tree
- SwingBuilder.viewport
- SwingBuilder.widget

- SwingBuilder.window
 - Categorical Widget List
 - Extending Swing Builder
- SwingXBuilder
 - Effects
 - Extending SwingXBuilder
 - Graphs
 - MultiSplitPane
 - Painters
 - Widgets and Common Attributes
- Input Output
- Integration
- JSR 223 Scripting with Groovy
- Logging
- Migration From Classic to JSR syntax
- Operators
 - Operator Overloading
- Process Management
- Processing XML
 - Creating XML using Groovy's MarkupBuilder
 - Creating XML using Groovy's StreamingMarkupBuilder
 - Creating XML with Groovy and DOM
 - Processing XML with XSLT
 - Reading XML using Groovy's DOMCategory
 - Reading XML using Groovy's XmlParser
 - Reading XML using Groovy's XmlSlurper
 - Reading XML with Groovy and DOM
 - Reading XML with Groovy and SAX
 - Reading XML with Groovy and StAX
 - Reading XML with Groovy and XPath
 - Updating XML with DOMCategory
 - Updating XML with XmlParser
 - Updating XML with XmlSlurper
 - Using Other XML Libraries
 - Creating XML with Groovy and DOM4J
 - Creating XML with Groovy and JDOM
 - Creating XML with Groovy and XOM
 - Processing XML with XQuery
 - Reading XML with Groovy and DOM4J
 - Reading XML with Groovy and JDOM
 - Reading XML with Groovy and XOM
 - Validating XML with a DTD

- Validating XML with a W3C XML Schema
- Validating XML with RELAX NG
- XML Example
- Regular Expressions
- Reserved Words
- Running Groovy on .NET 2.0 using IKVM
- Scoping and the Semantics of "def"
- Scripts and Classes
- Statements
- Static Import Usage
- Strings
- Things to remember
- Things you can do but better leave undone
- Using Enums
- Using Spring Factories with Groovy
- Reference

Advanced Usage Guide

This page last changed on Aug 21, 2007 by [jhermann](#).

This guide provides information that you don't need when first starting to learn Groovy but can come in handy when you want to push the boundaries of the language or improve your Groovy style.

- [Ant Task Troubleshooting](#)
- [BuilderSupport](#)
- [Compiling Groovy](#)
 - [Compiling With Maven2](#)
- [Design Patterns with Groovy](#)
 - [Abstract Factory Pattern](#)
 - [Adapter Pattern](#)
 - [Bouncer Pattern](#)
 - [Chain of Responsibility Pattern](#)
 - [Composite Pattern](#)
 - [Decorator Pattern](#)
 - [Delegation Pattern](#)
 - [Flyweight Pattern](#)
 - [Iterator Pattern](#)
 - [Loan my Resource Pattern](#)
 - [Null Object Pattern](#)
 - [Pimp my Library Pattern](#)
 - [Proxy Pattern](#)
 - [Singleton Pattern](#)
 - [State Pattern](#)
 - [Strategy Pattern](#)
 - [Template Method Pattern](#)
 - [Visitor Pattern](#)
- [Dynamic language beans in Spring](#)
- [Embedding Groovy](#)
- [Influencing class loading at runtime](#)
- [Internationalization](#)
- [Make a builder](#)
- [Mixed Java and Groovy Applications](#)
- [Optimising Groovy bytecodes with Soot](#)
- [Polyglot Programming with Groovy](#)
 - [Constraint Programming](#)
 - [Functional Programming](#)
 - [JSR-223 access to other JVM languages](#)
- [Refactoring with Groovy](#)
 - [Introduce Assertion](#)
 - [Replace Inheritance with Delegation](#)
- [Security](#)
- [Writing Domain-Specific Languages](#)

Ant Task Troubleshooting

This page last changed on Oct 20, 2007 by [paulk_asert](#).

Ant Task Troubleshooting

The Common Problem

Very often, the groovy or groovyc tasks fail with a `ClassNotFoundException` for the class `GroovySourceAst`.

The Reason

If it's failing with a `ClassNotFoundException` for a class other than `GroovySourceAst`, welcome to Ant. As the Ant manual for [external tasks](#) says, "Don't add anything to the `CLASSPATH` environment variable - this is often the reason for very obscure errors. Use Ant's own mechanisms for adding libraries." And as its [library directories](#) section says, "Ant should work perfectly well with an empty `CLASSPATH` environment variable, something the the `-noclasspath` option actually enforces. We get many more support calls related to classpath problems (especially quoting problems) than we like." So try running Ant as `ant -noclasspath`, or even alias ant to that in your shell.

If the class that isn't found is `GroovySourceAst` and the above doesn't help, somewhere you have a conflicting antlr in your classpath. This may be because you are using maven and one of this parts is polluting the classpath or you have a different antlr jar in your classpath somewhere.

Solution 1: groovy-all

Use the `groovy-all-VERSION.jar` from the groovy distribution and not the normal groovy jar. The `groovy-all-VERSION.jar` does already contain antlr and asm libs in a separate namespace so there should be no conflict with other libs around.

Solution 2: using loaderref

Sometimes it's not possible to use the `groovy-all-VERSION.jar`, for example because you want to build groovy before creating the jar. In this case you have to add a `loaderref` to the task definition. But that alone will not help. You have to add the `rootLoaderRef` task to set this loader reference. For example:

```
<taskdef name="rootLoaderRef"
classname="org.codehaus.groovy.ant.RootLoaderRef"
classpathref="task.classpath"/>

<rootLoaderRef ref="tmp.groovy.groovyc">
<classpath refid="execution.classpath"/>
</rootLoaderRef>

<rootLoaderRef />

<taskdef name="groovy"
classname="org.codehaus.groovy.ant.Groovy"
loaderref="tmp.groovy.groovyc"/>
```

The groovy task will now be created using the `tmp.groovy.groovyc` class loader, which tries to avoid loading conflicting jars like antlr. It's important to execute the `rootLoaderRef` task once before the taskdef using the loaderref defined by the `rootLoaderRef`.

Solution 3: appropriate classpath set up

You may need to adjust your classpath setup to include the jars you are trying to use. For instance, if you have placed the groovy jar in your Ant LIB folder, then Groovy will be in Ant's root classloader. If you now wish to refer to an external library, e.g. a JDBC driver, you may need to place that library also in your Ant LIB folder so that it is visible in the same classLoader as Groovy. See the loaderref discussion above also.

Also, the Groovy distribution doesn't include the entire Ant distribution. If you are using some optional Ant tasks, you may need to add some additional jars to your classpath to use the additional features. Here is an incomplete list of some Ant tasks which require additional jars:

Ant Task	Additional Jar(s)
junitreport	ant-trax.jar, xercesImpl.jar, xml-apis.jar
mail	mail.jar, activation.jar, smtp.jar (if using SMTP), ant-javamail.jar (if sending MIME email)
sql	<i>your_JDBC_driver</i>

All Solved?

No, both Solutions will not help if you have conflicting ant jars or common-logging jars somewhere. Solution 2 is able to solve much more difficult jar problems as long as your classpath is as clean as possible. if you want to be on the safe side you have to fork the javaVM which means you have to use the task like this:

```
<!-- lets fork a JVM to avoid classpath hell -->
<java classname="org.codehaus.groovy.ant.Groovyc" fork="yes" failonerror="true">
<classpath refid="project.classpath"/>
<arg value="${build.classes.dir}"/>
<arg value="${src.dir}"/>
</java>
```

References

- [Ant Integration with Groovy](#)
- [Developing Custom Tasks](#)

BuilderSupport

This page last changed on Apr 04, 2007 by [mszklano](#).

I was curious how the abstract BuildSupport class is working that does all those great things for e.g. the SwingBuilder and AntBuilder.

So I wrote the following Groovy Test that exposes its behaviour:

```
package groovy.util

class SpoofBuilder extends BuilderSupport{
def log = []
protected void setParent(Object parent, Object child){
log << "sp"
log << parent
log << child
}
protected Object createNode(Object name){
log << 'cn1'
log << name
return 'x'
}
protected Object createNode(Object name, Object value){
log << 'cn2'
log << name
log << value
return 'x'
}
protected Object createNode(Object name, Map attributes){
log << 'cn3'
log << name
attributes.each{entry -> log << entry.key; log << entry.value}
return 'x'
}
protected Object createNode(Object name, Map attributes, Object value){
log << 'cn4'
log << name
attributes.each{entry -> log << entry.key; log << entry.value}
log << value
return 'x'
}
protected void nodeCompleted(Object parent, Object node) {
log << 'nc'
log << parent
log << node
}
}

// simple node
def b = new SpoofBuilder()
assert b.log == []
def node = b.foo()
assert b.log == ['cn1','foo','nc',null, node]

// simple node with value
def b = new SpoofBuilder()
def node = b.foo('value')
assert b.log == ['cn2','foo','value', 'nc',null,node]

// simple node with one attribute
def b = new SpoofBuilder()
def node = b.foo(name:'value')
assert b.log == [
'cn3','foo', 'name','value', 'nc',null,'x']
```

```
// how is closure applied?
def b = new SpoofBuilder()
b.foo(){
b.bar()
}
assert b.log == [
'cn1','foo',
'cn1','bar',
'sp', 'x', 'x',
'nc','x','x',
'nc',null,'x']
```

The SpoofBuilder is a sample instance of the abstract BuilderSupport class that does nothing but logging how it was called, returning 'x' for each node.

The test sections call the SpoofBuilder in various ways and the log reveals what methods were called during the "Build".

This test allowed me to verify my assumption on how the builder pattern works here. I used this knowledge to write a specialized AntBuilder for

[Canoo WebTest](#)

. This "MacroStepBuilder" allows using the Canoo WebTest "steps" (that walk through a webapp for testing) from Groovy Code. Groovy has now become a first-class citizen in the

[Canoo WebTest Community](#)

.

When writing the above test I stumbled over a few things, here are two of them:

- I was not able to write a fully fledged subclass of GroovyTestCase with separate methods for the various tests. I couldn't find out how to make the SpoofBuilder an inner class of my TestCase. I would very much appreciate help on this.
- Coming from Ruby I expected the << operator on Strings to operate on the String itself (like it does on Lists) rather than giving back a modified copy. It appears to me that << on Strings and on Lists is not consistent. Same with the "+" operator.

What I especially appreciated:

- == on Lists is clear and compact
- display of evaluated expression when assert fails saves a lot of work when writing assertions. Most of the time you need no extra message.

keep up the good work!
mittie

Compiling Groovy

This page last changed on Sep 04, 2007 by [biafra](#).

There are various options for compiling Groovy code and then either running it or using the Java objects it creates in Java code.

Compiling Groovy code to bytecode using a script

There is an Ant task called **groovyc** which works pretty similarly to the **javac** Ant task which takes a bunch of groovy source files and compiles them into Java bytecode. Each groovy class then just becomes a normal Java class you can use inside your Java code if you wish.

Indeed the generated Java class is indistinguishable from a normal Java class, other than it implements the

[GroovyObject](#) interface.

Compiling Groovy code to bytecode using Ant and Maven

The [groovyc](#) Ant task is implemented by the [Groovyc](#) class. You can see an example of this in action inside Groovy's maven.xml file (just search for 'groovyc')

There is also an excellent [article on DeveloperWorks](#) which will show you how to compile Groovy code from within Maven, similarly to what is done with Ant.

You can also use the Ant task [from within Maven2](#), or the [groovy-maven-plugin](#)

Dynamically using Groovy inside Java applications

If you don't want to explicitly compile groovy code to bytecode you can just [embed groovy](#) directly into your Java application.

Runtime dependencies

As well as Java 1.4, or above, and the Groovy jar we also depend at runtime on the ASM library (asm and asm-tree mainly), as well as Antlr. You can also use the groovy-all-xxx.jar from your GROOVY_HOME/embeddable directory, which embeds ASM and Antlr in its own namespace, to avoid Jar version hell.

Compiling With Maven2

This page last changed on Sep 24, 2006 by [paulk_asert](#).

Here's an example of a Maven2 build using the Ant plugin to compile a groovy project. Note that the Ant plugin is bound to the compile and test-compile phases of the build in the example below. It will be invoked during these phases and the contained tasks will be carried out which runs the Groovy compiler over the source and test directories. The resulting Java classes will coexist with and be treated like any standard Java classes compiled from Java source and will appear no different to the JRE, or the JUnit runtime.

```
<project xmlns="http://maven.apache.org/POM/4.0.0" xmlns:xsi="http://www.w3.org/2001/XMLSchema-
instance"
xsi:schemaLocation="http://maven.apache.org/POM/4.0.0 http://maven.apache.org/maven-v4_0_0.xsd">
<modelVersion>4.0.0</modelVersion>
<groupId>com.mycomp.MyGroovy</groupId>
<artifactId>MyGroovy</artifactId>
<packaging>jar</packaging>
<version>1.0-SNAPSHOT</version>
<name>Maven Example building a Groovy project</name>
<dependencies>
<dependency>
<groupId>junit</groupId>
<artifactId>junit</artifactId>
<version>3.8.1</version>
<scope>test</scope>
</dependency>
<dependency>
<groupId>groovy</groupId>
<artifactId>groovy-all-1.0-jsr</artifactId>
<version>05</version>
</dependency>
</dependencies>
<build>
<plugins>
<plugin>
<artifactId>maven-antrun-plugin</artifactId>
<executions>
<execution>
<id>compile</id>
<phase>compile</phase>
<configuration>
<tasks>
<taskdef name="groovyc"
classname="org.codehaus.groovy.ant.Groovyc">
<classpath refid="maven.compile.classpath"/>
</taskdef>
<mkdir dir="${project.build.outputDirectory}"/>
<groovyc destdir="${project.build.outputDirectory}"
srcdir="${basedir}/src/main/groovy/" listfiles="true">
<classpath refid="maven.compile.classpath"/>
</groovyc>
</tasks>
</configuration>
<goals>
<goal>run</goal>
</goals>
</execution>
<execution>
<id>test-compile</id>
<phase>test-compile</phase>
<configuration>
<tasks>
<taskdef name="groovyc"
classname="org.codehaus.groovy.ant.Groovyc">
<classpath refid="maven.compile.classpath"/>
```

```
</taskdef>
<mkdir dir="${project.build.testOutputDirectory}"/>
<groovyc destdir="${project.build.testOutputDirectory}"
srcdir="${basedir}/src/test/groovy/" listfiles="true">
<classpath refid="maven.test.classpath"/>
</groovyc>
</tasks>
</configuration>
<goals>
<goal>run</goal>
</goals>
</execution>
</executions>
</plugin>
</plugins>
</build>
</project>
```

This assumes you have a Maven project setup with "groovy" subfolders as peers to the java src and test subfolders. You can use the java/jar archetype to set this up then rename the java folders to groovy or keep the java folders and just create groovy peer folders. There exists, also a groovy plugin which has not been tested or used in production. After defining the build section as in the above example, you can invoke the typical Maven build phases normally. For example, "mvn test" will execute the test phase, compiling Groovy source and Groovy test source and finally executing the unit tests. If you run "mvn jar" it will execute the jar phase bundling up all of your compiled production classes into a jar after all of the unit tests pass. For more detail on Maven build phases consult the Maven2 documentation.

Design Patterns with Groovy

This page last changed on Aug 07, 2007 by [paulk_asert](#).

Using [design patterns](#) with Java is a well-established topic. Design patterns also apply to Groovy:

- some patterns carry over directly (and can make use of normal Groovy syntax improvements for greater readability)
- some patterns are no longer required because they are built right into the language or because Groovy supports a better way of achieving the intent of the pattern
- some patterns that have to be expressed at the design level in other languages can be implemented directly in Groovy (due to the way Groovy can blur the distinction between design and implementation)

Patterns

- [Abstract Factory Pattern](#)
- [Adapter Pattern](#)
- [Bouncer Pattern](#)
- [Chain of Responsibility Pattern](#)
- [Composite Pattern](#)
- [Decorator Pattern](#)
- [Delegation Pattern](#)
- [Flyweight Pattern](#)
- [Iterator Pattern](#)
- [Loan my Resource Pattern](#)
- [Null Object Pattern](#)
- [Pimp my Library Pattern](#)
- [Proxy Pattern](#)
- [Singleton Pattern](#)
- [State Pattern](#)
- [Strategy Pattern](#)
- [Template Method Pattern](#)
- [Visitor Pattern](#)

References

1. Erich Gamma, Richard Helm, Ralph Johnson, John Vlissides (1995). *Design Patterns: Elements of Reusable Object-Oriented Software*. Addison-Wesley. ISBN 0-201-63361-2.
 - *The canonical reference of design patterns.*
2. Martin Fowler (1999). *Refactoring: Improving the Design of Existing Code*. Addison-Wesley. ISBN 0-201-48567-2.
3. Joshua Kerievsky (2004). *Refactoring To Patterns*. Addison-Wesley. ISBN 0-321-21335-1.
4. Eric Freeman, Elisabeth Freeman, Kathy Sierra, Bert Bates (2004). *Head First Design Patterns*. O'Reilly. ISBN 0-596-00712-4.
 - *A great book to read, informative as well as amusing.*
5. Dierk Koenig with Andrew Glover, Paul King, Guillaume Laforge and Jon Skeet (2007). *Groovy in Action*. Manning. ISBN 1-932394-84-2.
 - *Discusses Visitor, Builder and other Patterns.*
6. Brad Appleton (1999). [Pizza Inversion - a Pattern for Efficient Resource Consumption](#).
 - *One of the most frequently used patterns by many software engineers!*

See also: [Refactoring with Groovy](#)

Abstract Factory Pattern

This page last changed on May 24, 2007 by [paulk_asert](#).

The [Abstract Factory Pattern](#) provides a way to encapsulate a group of individual factories that have a common theme. It embodies the intent of a normal factory, i.e. remove the need for code using an interface to know the concrete implementation behind the interface, but applies to a set of interfaces and selects an entire family of concrete classes which implement those interfaces.

As an example, I might have interfaces Button, TextField and Scrollbar. I might have WindowsButton, MacButton, FlashButton as concrete classes for Button. I might have WindowsScrollBar, MacScrollBar and FlashScrollBar as concrete implementations for Scrollbar. Using the Abstract Factory Pattern should allow me to select which windowing system (i.e. Windows, Mac, Flash) I want to use once and from then on should be able to write code that references the interfaces but is always using the appropriate concrete classes (all from the one windowing system) under the covers.

Example

Suppose we want to write a game system. We might note that many games have very similar features and control.

We decide to try to split the common and game-specific code into separate classes.

First let's look at the game-specific code for a [Two-up](#) game:

```
class TwoupMessages {
def welcome = 'Welcome to the twoup game, you start with $1000'
def done = 'Sorry, you have no money left, goodbye'
}

class TwoupInputConverter {
def convert(input) { input.toInteger() }
}

class TwoupControl {
private money = 1000
private random = new Random()
private tossWasHead() {
def next = random.nextInt()
return next % 2 == 0
}
def moreTurns() {
if (money > 0) {
println "You have $money, how much would you like to bet?"
return true
}
return false
}
def play(amount) {
def coin1 = tossWasHead()
def coin2 = tossWasHead()
if (coin1 && coin2) {
money += amount
println 'You win'
} else if (!coin1 && !coin2) {
money -= amount
println 'You lose'
} else println 'Draw'
}
}
```

Now, let's look at the game-specific code for a number guessing game:

```
class GuessGameMessages {
def welcome = 'Welcome to the guessing game, my secret number is between 1 and 100'
def done = 'Correct'
```



```

}

class GuessGameInputConverter {
def convert(input) { input.toInteger() }
}

class GuessGameControl {
private lower = 1
private upper = 100
private guess = new Random().nextInt(upper - lower) + lower
def moreTurns() {
def done = (lower == guess || upper == guess)
if (!done) println "Enter a number between $lower and $upper"
!done
}
def play(nextGuess) {
if (nextGuess <= guess) lower = [lower, nextGuess].max()
if (nextGuess >= guess) upper = [upper, nextGuess].min()
}
}
}

```

Now, let's write our factory code:

```

def guessFactory = [messages:GuessGameMessages, control:GuessGameControl,
converter:GuessGameInputConverter]
def twoupFactory = [messages:TwoupMessages, control:TwoupControl, converter:TwoupInputConverter]

class GameFactory {
def static factory
def static getMessages() { return factory.messages.newInstance() }
def static getControl() { return factory.control.newInstance() }
def static getConverter() { return factory.converter.newInstance() }
}

```

The important aspect of this factory is that it allows selection of an entire family of concrete classes.

Here is how we would use the factory:

```

GameFactory.factory = twoupFactory
def messages = GameFactory.messages
def control = GameFactory.control
def converter = GameFactory.converter
println messages.welcome
def reader = new BufferedReader(new InputStreamReader(System.in))
while (control.moreTurns()){
def input = reader.readLine().trim()
control.play(converter.convert(input))
}
println messages.done

```

Note that the first line configures which family of concrete game classes we will use. It's not important that we selected which family to use by using the factory property as shown in the first line. Other ways would be equally valid examples of this pattern. For example, we may have asked the user which game they wanted to play or determined which game from an environment setting.

With the code as shown, the game might look like this when run:

```

Welcome to the twoup game, you start with $1000
You have 1000, how much would you like to bet?
300
Draw
You have 1000, how much would you like to bet?
700
You win
You have 1700, how much would you like to bet?
1700
You lose

```

Sorry, you have no money left, goodbye

If we change the first line of the script to `GameFactory.factory = guessFactory`, then the sample run might look like this:

```
Welcome to the guessing game, my secret number is between 1 and 100
Enter a number between 1 and 100
75
Enter a number between 1 and 75
35
Enter a number between 1 and 35
15
Enter a number between 1 and 15
5
Enter a number between 5 and 15
10
Correct
```

Adapter Pattern

This page last changed on May 19, 2007 by [paulk_asert](#).

The [Adapter Pattern](#) (sometimes called the wrapper pattern) allows objects satisfying one interface to be used where another type of interface is expected. There are two typical flavours of the pattern: the *delegation* flavour and the *inheritance* flavour.

Delegation Example

Suppose we have the following classes (inspired by [this](#)):

```
class SquarePeg {
  def width
}

class RoundPeg {
  def radius
}

class RoundHole {
  def radius
  def pegFits(peg) {
    peg.radius <= radius
  }
  String toString() { "RoundHole with radius $radius" }
}
```

We can ask the `RoundHole` class if a `RoundPeg` fits in it, but if we ask the same question for a `SquarePeg`, then it will fail because the `SquarePeg` class doesn't have a `radius` property (i.e. doesn't satisfy the required interface).

To get around this problem, we can create an adapter to make it appear to have the correct interface. It would look like this:

```
class SquarePegAdapter {
  def peg
  def getRadius() {
    Math.sqrt(((peg.width/2) ** 2)*2)
  }
  String toString() {
    "SquarePegAdapter with peg width $peg.width (and notional radius $radius)"
  }
}
```

We can use the adapter like this:

```
def hole = new RoundHole(radius:4.0)
(4..7).each { w ->
  def peg = new SquarePegAdapter(peg:new SquarePeg(width:w))
  if (hole.pegFits(peg))
    println "peg $peg fits in hole $hole"
  else
    println "peg $peg does not fit in hole $hole"
}
```

Which results in the following output:

```
peg SquarePegAdapter with peg width 4 (and notional radius 2.8284271247461903) fits in hole
RoundHole with radius 4.0
peg SquarePegAdapter with peg width 5 (and notional radius 3.5355339059327378) fits in hole
RoundHole with radius 4.0
peg SquarePegAdapter with peg width 6 (and notional radius 4.242640687119285) does not fit in hole
RoundHole with radius 4.0
peg SquarePegAdapter with peg width 7 (and notional radius 4.949747468305833) does not fit in hole
RoundHole with radius 4.0
```

Inheritance Example

Let's consider the same example again using inheritance. First, here are the original classes (unchanged):

```
class SquarePeg {
  def width
}

class RoundPeg {
  def radius
}

class RoundHole {
  def radius
  def pegFits(peg) {
    peg.radius <= radius
  }
  String toString() { "RoundHole with radius $radius" }
}
```

An adapter using inheritance:

```
class SquarePegAdapter extends SquarePeg {
  def getRadius() {
    Math.sqrt(((width/2) ** 2)*2)
  }
  String toString() {
    "SquarePegAdapter with width $width (and notional radius $radius)"
  }
}
```

Using the adapter:

```
def hole = new RoundHole(radius:4.0)
(4..7).each { w ->
  def peg = new SquarePegAdapter(width:w)
  if (hole.pegFits(peg))
    println "peg $peg fits in hole $hole"
  else
    println "peg $peg does not fit in hole $hole"
}
```

The output:

```
peg SquarePegAdapter with width 4 (and notional radius 2.8284271247461903) fits in hole RoundHole
with radius 4.0
peg SquarePegAdapter with width 5 (and notional radius 3.5355339059327378) fits in hole RoundHole
with radius 4.0
peg SquarePegAdapter with width 6 (and notional radius 4.242640687119285) does not fit in hole
RoundHole with radius 4.0
peg SquarePegAdapter with width 7 (and notional radius 4.949747468305833) does not fit in hole
RoundHole with radius 4.0
```

Adapting using Closures

As a variation of the previous examples, we could instead define the following interface:

```
interface RoundThing {
  def getRadius()
}
```

We can then define an adapter as a closure as follows:

```
def adapter = {
  p -> [getRadius: {Math.sqrt(((p.width/2) ** 2)*2)}] as RoundThing
}
```

And use it like this:

```
def peg = new SquarePeg(width:w)
if (hole.pegFits(adapter(peg)))
// ... as before
```

Adapting using the ExpandoMetaClass

As of Groovy 1.1, there is a built-in MetaClass which can automatically add properties and methods dynamically.

Here is how the example would work using that feature:

```
def peg = new SquarePeg(width:w)
peg.metaClass.radius = Math.sqrt(((peg.width/2) ** 2)*2)
```

After you create a peg object, you can simply add a property to it on the fly. No need to change the original class and no need for an adapter class.

Note that at the moment you have to be using Groovy 1.1 (currently in beta) and you have to initialise the new MetaClass with the following code:

```
GroovySystem.metaClassRegistry.metaClassCreationHandle = new ExpandoMetaClassCreationHandle()
```

The need for this last line may go away before the final release of Groovy 1.1.

Bouncer Pattern

This page last changed on Feb 12, 2008 by [fjanon](#).

The [Bouncer Pattern](#) describes usage of a method whose sole purpose is to either throw an exception (when particular conditions hold) or do nothing. Such methods are often used to defensively guard pre-conditions of a method.

When writing utility methods, you should always guard against faulty input arguments. When writing internal methods, you may be able to ensure that certain pre-conditions always hold by having sufficient unit tests in place. Under such circumstances, you may reduce the desirability to have guards on your methods.

Groovy differs from other languages in that you frequently use the `assert` method within your methods rather than having a large number of utility checker methods or classes.

Null Checking Example

We might have a utility method such as:

```
class NullChecker {
    static check(name, arg) {
        if (arg == null)
            throw new IllegalArgumentException(name + " is null")
    }
}
```

And we would use it like this:

```
public void doStuff(String name, Object value) {
    NullChecker.check("name", name);
    NullChecker.check("value", value);
    // do stuff
}
```

But a more Groovy way to do this would simply be like this:

```
public void doStuff(String name, Object value) {
    assert name != null, 'name should not be null'
    assert value != null, 'value should not be null'
    // do stuff
}
```

Validation Example

As an alternative example, we might have this utility method:

```
public class NumberChecker {
    static final NUMBER_PATTERN = /\d+(\.\d+(E-?\d+)?)?/
    static isNumber(str) {
        if (!str =~ NUMBER_PATTERN)
            throw new IllegalArgumentException("/Argument '$str' must be a number/")
    }
    static isNotZero(number) {
        if (number == 0)
            throw new IllegalArgumentException('Argument must not be 0')
    }
}
```

And we would use it like this:

```
def stringDivide(String dividendStr, String divisorStr) {
    NumberChecker.isNumber(dividendStr)
    NumberChecker.isNumber(divisorStr)
    def dividend = dividendStr.toDouble()
    def divisor = divisorStr.toDouble()
}
```

```
NumberChecker.isNotZero(divisor)
dividend / divisor
}

println stringDivide('1.2E2', '3.0')
// => 40.0
```

But with Groovy we could just as easily use:

```
def stringDivide(String dividendStr, String divisorStr) {
  assert dividendStr =~ NumberChecker.NUMBER_PATTERN
  assert divisorStr =~ NumberChecker.NUMBER_PATTERN
  def dividend = dividendStr.toDouble()
  def divisor = divisorStr.toDouble()
  assert divisor != 0, 'Divisor must not be 0'
  dividend / divisor
}
```

Chain of Responsibility Pattern

This page last changed on May 14, 2007 by [paulk_asert](#).

In the [Chain of Responsibility Pattern](#), objects using and implementing an interface (one or more methods) are intentionally loosely coupled. A set of objects that *implement* the interface are organised in a list (or in rare cases a tree). Objects using the interface make requests from the first *implementor* object. It will decide whether to perform any action itself and whether to pass the request further down the line in the list (or tree). Sometimes a default implementation for some request is also coded into the pattern if none of the implementors respond to the request.

Example

In this example, the script sends requests to the `lister` object. The `lister` points to a `UnixLister` object. If it can't handle the request, it sends the request to the `WindowsLister`. If it can't handle the request, it sends the request to the `DefaultLister`.

```
class UnixLister {
private nextInLine
UnixLister(next) { nextInLine = next }
def listFiles(dir) {
if (System.getProperty('os.name') == 'Linux')
println "ls $dir".execute().text
else
nextInLine.listFiles(dir)
}
}

class WindowsLister {
private nextInLine
WindowsLister(next) { nextInLine = next }
def listFiles(dir) {
if (System.getProperty('os.name') == 'Windows XP')
println "cmd.exe /c dir $dir".execute().text
else
nextInLine.listFiles(dir)
}
}

class DefaultLister {
def listFiles(dir) {
new File(dir).eachFile{ f -> println f }
}
}

def lister = new UnixLister(new WindowsLister(new DefaultLister()))

lister.listFiles('Downloads')
```

The output will be a list of files (with slightly different format depending on the operating system).

Here is a UML representation:

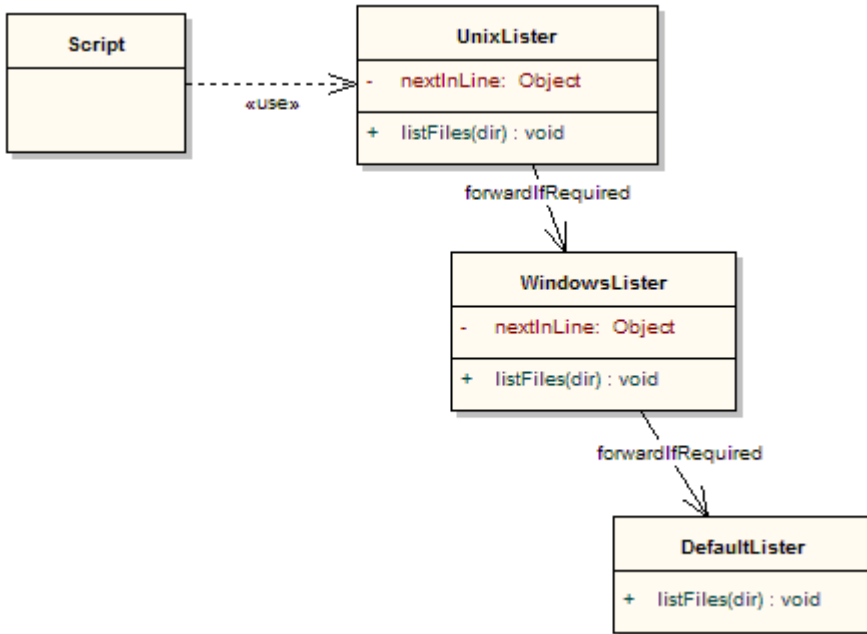

Variations to this pattern:

- we could have an explicit interface, e.g. `Listner`, to statically type the implementations but because of *duck-typing* this is optional
- we could use a chain tree instead of a list, e.g. `if (animal.hasBackbone()) delegate to VertebrateHandler else delegate to InvertebrateHandler`
- we could always pass down the chain even if we processed a request
- we could decide at some point to not respond and not pass down the chain
- we could use Groovy's meta-programming capabilities to pass unknown methods down the chain

Composite Pattern

This page last changed on May 07, 2007 by paulk_asert.

The [Composite Pattern](#) allows you to treat single instances of an object the same way as a group of objects. The pattern is often used with hierarchies of objects. Typically, one or more methods should be callable in the same way for either *leaf* or *composite* nodes within the hierarchy. In such a case, composite nodes typically invoke the same named method for each of their children nodes.

An Example

Consider this usage of the composite pattern where we want to call `toString()` on either `Leaf` or `Composite` objects.

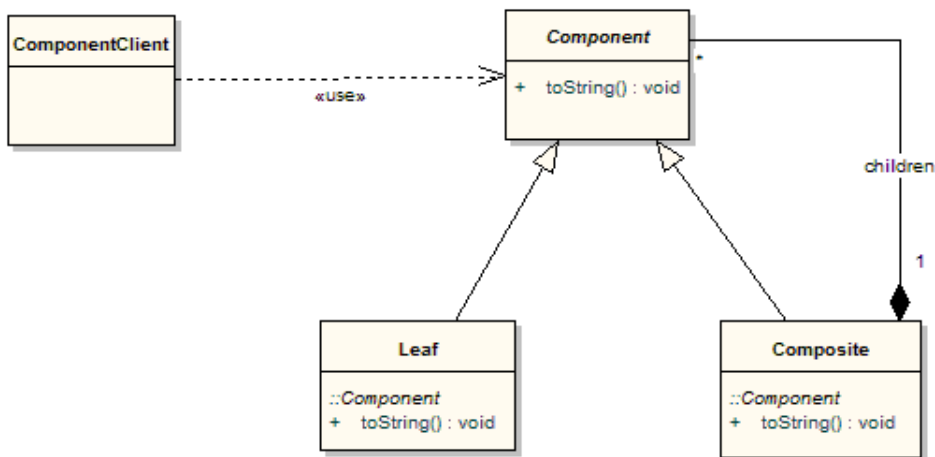

In Java, the `Component` class is essential as it provides the type used for both leaf and composite nodes. In Groovy, because of duck-typing, we don't need it for that purpose, however, it can still server as a useful place to place common behaviour between the leaf and composite nodes.

For our purposes, we will assemble the following hierarchy of components.

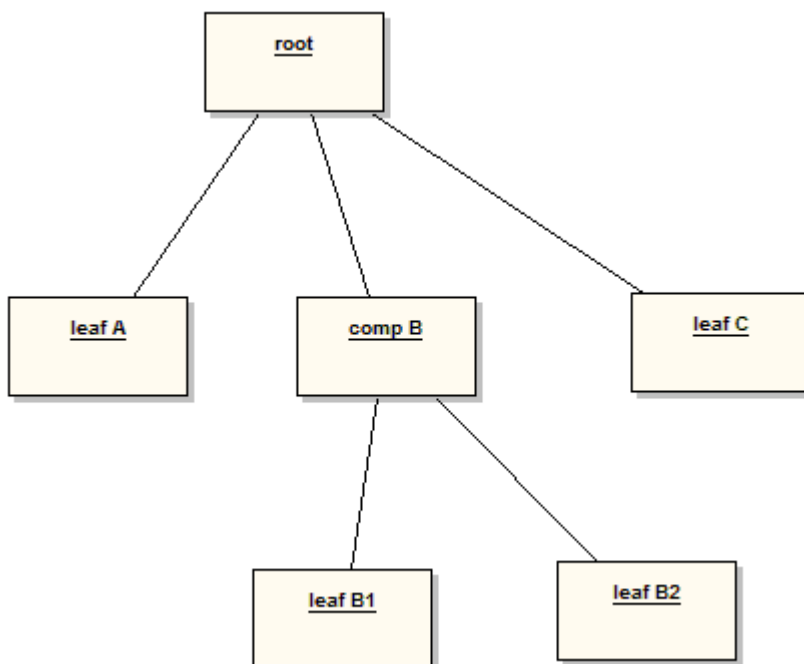

Here is the code:

```
abstract class Component {
```

```

def name
def toString(indent) {
("-" * indent) + name
}
}

class Composite extends Component {
private children = []
def toString(indent) {
def s = super.toString(indent)
children.each{ child ->
s += "\n" + child.toString(indent+1)
}
return s
}
def leftShift(component) {
children << component
}
}

class Leaf extends Component {}

def root = new Composite(name:"root")
root << new Leaf(name:"leaf A")
def comp = new Composite(name:"comp B")
root << comp
root << new Leaf(name:"leaf C")
comp << new Leaf(name:"leaf B1")
comp << new Leaf(name:"leaf B2")
println root.toString(0)

```

Here is the resulting output:

```

root
-leaf A
-comp B
--leaf B1
--leaf B2
-leaf C

```

Decorator Pattern

This page last changed on Feb 22, 2008 by [dsmiley](#).

The [Decorator Pattern](#) provides a mechanism to embellish the behaviour of an object without changing its essential interface. A decorated object should be able to be substituted wherever the original (non-decorated) object was expected. Decoration typically does not involve modifying the source code of the original object and decorators should be able to be combined in flexible ways to produce objects with several embellishments.

Traditional Example

Suppose we have the following `Logger` class.

```
class Logger {
  def log(String message) {
    println message
  }
}
```

There might be times when it is useful to timestamp a log message, or times when we might want to change the case of the message. We could try to build all of this functionality into our `Logger` class. If we did that, the `Logger` class would start to be very complex. Also, everyone would obtain all of features even when they might not want a small subset of the features. Finally, feature interaction would become quite difficult to control.

To overcome these drawbacks, we instead define two decorator classes. Uses of the `Logger` class are free to embellish their base logger with zero or more decorator classes in whatever order they desire. The classes look like this:

```
class TimeStampingLogger extends Logger {
  private Logger logger
  TimeStampingLogger(logger) {
    this.logger = logger
  }
  def log(String message) {
    def now = Calendar.instance
    logger.log("$now.time: $message")
  }
}
```

```
class UpperLogger extends Logger {
  private Logger logger
  UpperLogger(logger) {
    this.logger = logger
  }
  def log(String message) {
    logger.log(message.toUpperCase())
  }
}
```

We can use the decorators like so:

```
def logger = new UpperLogger(new TimeStampingLogger(new Logger()))
logger.log("G'day Mate")
// => Tue May 22 07:13:50 EST 2007: G'DAY MATE
```

You can see that we embellish the logger behaviour with both decorators. Because of the order we chose to apply the decorators, our log message comes out capitalised and the timestamp is in normal case. If we swap the order around, let's see what happens:

```
logger = new TimeStampingLogger(new UpperLogger(new Logger()))
logger.log('Hi There')
// => TUE MAY 22 07:13:50 EST 2007: HI THERE
```

Now the timestamp itself has also been changed to be uppercase.

A touch of dynamic behaviour

Our previous decorators were specific to `Logger` objects. We can use Groovy's Meta-Object Programming capabilities to create a decorator which is far more general purpose in nature. Consider this class:

```
class GenericLowerDecorator {
  private delegate
  GenericLowerDecorator(delegate) {
    this.delegate = delegate
  }
  def invokeMethod(String name, args) {
    def newargs = args.collect{ arg ->
      if (arg instanceof String) return arg.toLowerCase()
      else return arg
    }
    delegate.invokeMethod(name, newargs)
  }
}
```

It takes any class and decorates it so that any `String` method parameter will automatically be changed to lower case.

```
logger = new GenericLowerDecorator(new TimeStampingLogger(new Logger()))
logger.log('IMPORTANT Message')
// => Tue May 22 07:27:18 EST 2007: important message
```

Just be careful with ordering here. The original decorators were restricted to decorating `Logger` objects. This decorator work with any object type, so we can't swap the ordering around, i.e. this won't work:

```
// Can't mix and match Interface-Oriented and Generic decorators
// logger = new TimeStampingLogger(new GenericLowerDecorator(new Logger()))
```

We could overcome this limitation by generating an appropriate Proxy type at runtime but we won't complicate the example here.

Runtime behaviour embellishment

You can also consider using the `ExpandoMetaClass` from Groovy 1.1 to dynamically embellish a class with behaviour. This isn't the normal style of usage of the decorator pattern (it certainly isn't nearly as flexible) but may help you to achieve similar results in some cases without creating a new class.

Here's what the code looks like:

```
// current mechanism to enable ExpandoMetaClass
GroovySystem.metaClassRegistry.metaClassCreationHandle = new ExpandoMetaClassCreationHandle()

def logger = new Logger()
logger.metaClass.log = { String m -> println 'message: ' + m.toUpperCase() }
logger.log('x')
// => message: X
```

This achieves a similar result to applying a single decorator but we have no way to easily apply and remove embellishments on the fly.

More dynamic decorating

Suppose we have a calculator class. (Actually any class would do.)

```
class Calc {
  def add(a, b) { a + b }
}
```

We might be interested in observing usage of the class over time. If it is buried deep within our codebase, it might be hard to determine when it is being called and with what parameters. Also, it might be hard to know if it is performing well. We can easily make a generic tracing decorator that prints out tracing

information whenever any method on the `Calc` class is called and also provide timing information about how long it took to execute. Here is the code for the tracing decorator:

```
class TracingDecorator {
private delegate
TracingDecorator(delegate) {
this.delegate = delegate
}
def invokeMethod(String name, args) {
println "Calling $name$args"
def before = System.currentTimeMillis()
def result = delegate.invokeMethod(name, args)
println "Got $result in ${System.currentTimeMillis()-before} ms"
result
}
}
```

Here is how to use the class in a script:

```
def tracedCalc = new TracingDecorator(new Calc())
assert 15 == tracedCalc.add(3, 12)
```

And here is what you would see after running this script:

```
Calling add{3, 12}
Got 15 in 31 ms
```

Decorating with an Interceptor

The above timing example hooks into the lifecycle of Groovy objects (via `invokeMethod`). This is such an important style performing meta-programming that Groovy has special support for this style of decorating using *interceptors*.

Groovy even comes with a built-in `TracingInterceptor`. We can extend the built-in class like this:

```
class TimingInterceptor extends TracingInterceptor {
private beforeTime
def beforeInvoke(object, String methodName, Object[] arguments) {
super.beforeInvoke(object, methodName, arguments)
beforeTime = System.currentTimeMillis()
}
public Object afterInvoke(Object object, String methodName, Object[] arguments, Object result) {
super.afterInvoke(object, methodName, arguments, result)
def duration = System.currentTimeMillis() - beforeTime
writer.write("Duration: $duration ms\n")
writer.flush()
return result
}
}
```

Here is an example of using this new class:

```
def proxy = ProxyMetaClass.getInstance(util.CalcImpl.class)
proxy.interceptor = new TimingInterceptor()
proxy.use {
assert 7 == new util.CalcImpl().add(1, 6)
}
```

And here is the output:

```
before util.CalcImpl.ctor()
after util.CalcImpl.ctor()
Duration: 0 ms
before util.CalcImpl.add(java.lang.Integer, java.lang.Integer)
after util.CalcImpl.add(java.lang.Integer, java.lang.Integer)
Duration: 16 ms
```

Decorating with java.lang.reflect.Proxy

If you are trying to decorate an object (i.e. just a particular instance of the class, not the class generally), then you can use Java's `java.lang.reflect.Proxy`. Groovy makes working with this easier than just Java. Below is a code sample taken out of a grails project that wraps a `java.sql.Connection` so that its `close` method is a no-op:

```
protected Sql getGroovySql() {
    final Connection con = session.connection()
    def invoker = { object, method, args ->
        if (method.name == "close") {
            log.debug("ignoring call to Connection.close() for use by groovy.sql.Sql")
        } else {
            log.trace("delegating $method")
            return con.invokeMethod(method.name, args)
        }
    } as InvocationHandler;
    def proxy = Proxy.newProxyInstance( getClass().getClassLoader(), [Connection] as Class[], invoker )
    return new Sql(proxy)
}
```

If there were many methods to intercept, then this approach could be modified to look up closure in a map by method name and invoke it.

Decorating with Spring

The [Spring Framework](#) allows decorators to be applied with *interceptors* (you may have heard the terms *advice* or *aspect*). You can leverage this mechanism from Groovy as well.

First define a class that you want to decorate (we'll also use an interface as is normal Spring practice):

Here's the interface:

```
package util

interface Calc {
    def add(a, b)
}
```

Here's the class:

```
package util

class CalcImpl implements Calc {
    def add(a, b) { a + b }
}
```

Now, we define our wiring in a file called `beans.xml` as follows:

```
<?xml version="1.0" encoding="UTF-8"?>
<beans xmlns="http://www.springframework.org/schema/beans"
    xmlns:xsi="http://www.w3.org/2001/XMLSchema-instance"
    xmlns:lang="http://www.springframework.org/schema/lang"
    xsi:schemaLocation="
    http://www.springframework.org/schema/beans http://www.springframework.org/schema/beans/spring-
    beans.xsd
    http://www.springframework.org/schema/lang http://www.springframework.org/schema/lang/spring-
    lang.xsd">
    <bean id="performanceInterceptor" autowire="no"
        class="org.springframework.aop.interceptor.PerformanceMonitorInterceptor">
        <property name="loggerName" value="performance"/>
    </bean>
    <bean id="calc" class="util.CalcImpl"/>
    <bean class="org.springframework.aop.framework.autoproxy.BeanNameAutoProxyCreator">
    <property name="beanNames" value="calc"/>
    <property name="interceptorNames" value="performanceInterceptor"/>
</beans>
```

```
</bean>  
</beans>
```

Now, our script looks like this:

```
import org.springframework.context.support.ClassPathXmlApplicationContext  
  
def ctx = new ClassPathXmlApplicationContext("beans.xml")  
def calc = ctx.getBean('calc')  
println calc.add(3, 25)
```

And when we run it, we see the results:

```
21/05/2007 23:02:35 org.springframework.aop.interceptor.PerformanceMonitorInterceptor  
invokeUnderTrace  
FINEST: Stopwatch 'util.Calc.add': running time (millis) = 16
```

You may have to adjust your `logging.properties` file for messages at log level `FINEST` to be displayed.

Delegation Pattern

This page last changed on Jul 19, 2007 by [paulk_asert](#).

The [Delegation Pattern](#) is a technique where an object's behavior (public methods) is implemented by delegating responsibility to one or more associated objects.

Groovy allows the traditional style of applying the delegation pattern, e.g. see [Replace Inheritance with Delegation](#).

In addition, the [ExpandoMetaClass](#) allows usage of this pattern to be encapsulated in a library. This allows Groovy to emulate similar libraries available for the Ruby language.

Consider the following library class:

```
class Delegator {
private targetClass
private delegate
Delegator(targetClass, delegate) {
this.targetClass = targetClass
this.delegate = delegate
}
def delegate(String methodName) {
delegate(methodName, methodName)
}
def delegate(String methodName, String asMethodName) {
targetClass.metaClass."$asMethodName" = delegate."&"$methodName"
}
def delegateAll(String[] names) {
names.each { delegate(it) }
}
def delegateAll(Map names) {
names.each { k, v -> delegate(k, v) }
}
def delegateAll() {
delegate.class.methods*.name.each { delegate(it) }
}
}
```

With this in your classpath, you can now apply the delegation pattern dynamically as shown in the following examples. First, consider we have the following classes:

```
class Person {
String name
}

class MortgageLender {
def borrowAmount(amount) {
"borrow \$$amount"
}
def borrowFor(thing) {
"buy $thing"
}
}

def lender = new MortgageLender()

def delegator = new Delegator(Person, lender)
```

We can now use the *delegator* to automatically borrow methods from the *lender* object to extend the *Person* class. We can borrow the methods as is or with a rename:

```
delegator.delegate 'borrowFor'
delegator.delegate 'borrowAmount', 'getMoney'

def p = new Person()
```

```
println p.borrowFor('present') // => buy present
println p.getMoney(50)         // => borrow $50
```

The first line above, adds the *borrowFor* method to the *Person* class by delegating to the *lender* object. The second line adds a *getMoney* method to the *Person* class by delegating to the *lender* object's *borrowAmount* method.

Alternatively, we could borrow multiple methods like this:

```
delegator.delegateAll 'borrowFor', 'borrowAmount'
```

Which adds these two methods to the *Person* class.

Or if we want all the methods, like this:

```
delegator.delegateAll()
```

Which will make all the methods in the delegate object available in the *Person* class.

Alternatively, we can use a map notation to rename multiple methods:

```
delegator.delegateAll borrowAmount:'getMoney', borrowFor:'getThing'
```

Flyweight Pattern

This page last changed on May 13, 2007 by paulk_asert.

The [Flyweight Pattern](#) is a pattern for greatly reducing memory requirements by not requiring that heavy-weight objects be created in large numbers when dealing with systems that contain many things that are mostly the same. If for instance, a document was modeled using a complex character class that knew about unicode, fonts, positioning, etc., then the memory requirements could be quite large for large documents if each physical character in the document required its own character class instance. Instead, characters themselves might be kept within Strings and we might have one character class (or a small number such as one character class for each font type) that knew the specifics of how to deal with characters.

In such circumstances, we call the state that is shared with many other things (e.g. the character type) *intrinsic* state. It is captured within the heavy-weight class. The state which distinguishes the physical character (maybe just its ASCII code or Unicode) is called its *extrinsic* state.

Example

First we are going to model some complex aircraft (the first being a hoax competitor of the second - not that is relevant to the example).

```
class Boeing797 {
  def wingspan = '80.8 m'
  def capacity = 1000
  def speed = '1046 km/h'
  def range = '14400 km'
  // ...
}

class Airbus380 {
  def wingspan = '79.8 m'
  def capacity = 555
  def speed = '912 km/h'
  def range = '10370 km'
  // ...
}
```



If we want to model our fleet, our first attempt might involve using many instances of these heavy-weight objects. It turns out though that only a few small pieces of state (our extrinsic state) change for each aircraft, so we will have singletons for the heavy-weight objects and capture the extrinsic state (bought date and asset number in the code below) separately.

```
class FlyweightFactory {
  static instances = [797: new Boeing797(), 380: new Airbus380()]
}

class Aircraft {
  private type // intrinsic state
  private assetNumber // extrinsic state
  private bought // extrinsic state
  Aircraft(typeCode, assetNumber, bought) {
    type = FlyweightFactory.instances[typeCode]
    this.assetNumber = assetNumber
    this.bought = bought
  }
  def describe() {
    println ""
    Asset Number: $assetNumber
    Capacity: $type.capacity people
    Speed: $type.speed
    Range: $type.range
  }
}
```

```
Bought: $bought
"""
}
}

def fleet = [
new Aircraft(380, 1001, '10-May-2007'),
new Aircraft(380, 1002, '10-Nov-2007'),
new Aircraft(797, 1003, '10-May-2008'),
new Aircraft(797, 1004, '10-Nov-2008')
]

fleet.each{ p -> p.describe() }
```

So here, even if our fleet contained hundreds of planes, we would only have one heavy-weight object for each type of aircraft.

As a further efficiency measure, we might use lazy creation of the flyweight objects rather than create the initial map up front as in the above example.

Running this script results in:

```
Asset Number: 1001
Capacity: 555 people
Speed: 912 km/h
Range: 10370 km
Bought: 10-May-2007
```

```
Asset Number: 1002
Capacity: 555 people
Speed: 912 km/h
Range: 10370 km
Bought: 10-Nov-2007
```

```
Asset Number: 1003
Capacity: 1000 people
Speed: 1046 km/h
Range: 14400 km
Bought: 10-May-2008
```

```
Asset Number: 1004
Capacity: 1000 people
Speed: 1046 km/h
Range: 14400 km
Bought: 10-Nov-2008
```

Iterator Pattern

This page last changed on May 07, 2007 by [paulk_asert](#).

The [Iterator Pattern](#) allows sequential access to the elements of an aggregate object without exposing its underlying representation.

Groovy has the iterator pattern built right in to many of its *closure* operators, e.g. `each` and `eachWithIndex` as well as the `for .. in` loop.

For example:

```
def printAll(container) {
  for (item in container) { println item }
}

def numbers = [1,2,3,4]
def months = [Mar:31, Apr:30, May:31]
def colors = [java.awt.Color.BLACK, java.awt.Color.WHITE]
printAll numbers
printAll months
printAll colors
```

Results in the output:

```
1
2
3
4
May=31
Mar=31
Apr=30
java.awt.Color[r=0,g=0,b=0]
java.awt.Color[r=255,g=255,b=255]
```

Another example:

```
colors.eachWithIndex{ item, pos ->
  println "Position $pos contains '$item'"
}
```

Results in:

```
Position 0 contains 'java.awt.Color[r=0,g=0,b=0]'
Position 1 contains 'java.awt.Color[r=255,g=255,b=255]'
```

The iterator pattern is also built in to other special operators such as the `eachByte`, `eachFile`, `eachDir`, `eachLine`, `eachObject`, `eachMatch` operators for working with streams, URLs, files, directories and regular expressions matches.

Loan my Resource Pattern

This page last changed on Jun 18, 2007 by [paulk_asert](#).

The [Loan my Resource](#) pattern ensures that a resource is deterministically disposed of once it goes out of scope.

This pattern is built in to many Groovy helper methods. You should consider using it yourself if you need to work with resources in ways beyond what Groovy supports.

Example

Consider the following code which works with a file. First we might write some line to the file and then print its size:

```
def f = new File('junk.txt')
f.withPrintWriter { pw ->
  pw.println(new Date())
  pw.println(this.class.name)
}
println f.size()
// => 42
```

We could also read back the contents of the file a line at a time and print each line out:

```
f.eachLine { line ->
  println line
}
// =>
// Mon Jun 18 22:38:17 EST 2007
// RunPattern
```

Note that normal Java `Reader` and `PrintWriter` objects were used under the covers by Groovy but the code writer did not have to worry about explicitly creating or closing those resources. The built-in Groovy methods *loan* the respective reader or writer to the closure code and then tidy up after themselves. So, you are using this pattern without having to do any work.

Sometimes however, you wish to do things slightly differently to what you can get for free using Groovy's built-in mechanisms. You should consider utilising this pattern within your own resource-handling operations.

Consider how you might process the list of words on each line within the file. We could actually do this one too using Groovy's built-in functions, but bear with us and assume we have to do some resource handling ourselves. Here is how we might write the code without using this pattern:

```
def reader = f.newReader()
reader.splitEachLine(' ') { wordList ->
  println wordList
}
reader.close()
// =>
// ["Mon", "Jun", "18", "22:38:17", "EST", "2007"]
// ["RunPattern"]
```

Notice that we now have an explicit call to `close()` in our code. If we didn't code it just right (here we didn't surround the code in a `try ... finally` block, we run the risk of leaving the file handle open.

Let's now apply the loan pattern. First, we'll write a helper method:

```
def withListOfWordsForEachLine(File f, Closure c) {
  def r = f.newReader()
  try {
    r.splitEachLine(' ', c)
  } finally {
    r?.close()
  }
}
```

Now, we can re-write our code as follows:

```
withListOfWordsForEachLine(f) { wordList ->
println wordList
}
// =>
// ["Mon", "Jun", "18", "22:38:17", "EST", "2007"]
// ["RunPattern"]
```

This is much simpler and has removed the explicit `close()`. This is now catered for in one spot so we can apply the appropriate level of testing or reviewing in just one spot to be sure we have no problems.

Null Object Pattern

This page last changed on May 25, 2007 by [paulk_asert](#).

The [Null Object Pattern](#) involves using a special object place-marker object representing null. Typically, if you have a reference to null, you can't invoke `reference.field` or `reference.method()`. You receive the dreaded `NullPointerException`. The null object pattern uses a special object representing null, instead of using an actual `null`. This allows you to invoke field and method references on the null object. The result of using the null object should semantically be equivalent to *doing nothing*.

Simple Example

Suppose we have the following system:

```
class Job {
  def salary
}

class Person {
  def name
  def Job job
}

def people = [
  new Person(name:'Tom', job:new Job(salary:1000)),
  new Person(name:'Dick', job:new Job(salary:1200)),
]

def biggestSalary = people.collect{ p -> p.job.salary }.max()
println biggestSalary
```

When run, this prints out 1200. Suppose now that we now invoke:

```
people << new Person(name:'Harry')
```

If we now try to calculate `biggestSalary` again, we receive a null pointer exception.

To overcome this problem, we can introduce a `NullJob` class and change the above statement to become:

```
class NullJob extends Job { def salary = 0 }

people << new Person(name:'Harry', job:new NullJob())
biggestSalary = people.collect{ p -> p.job.salary }.max()
println biggestSalary
```

This works as we require but it's not always the best way to do this with Groovy. Groovy's safe-dereference operator (`?.`) operator and null aware closures often allow Groovy to avoid the need to create a special null object or null class. This is illustrated by examining a groovier way to write the above example:

```
people << new Person(name:'Harry')
biggestSalary = people.collect{ p -> p.job?.salary }.max()
println biggestSalary
```

Two things are going on here to allow this to work. First of all, `max()` is *'null aware'* so that `[300, null, 400].max() == 400`. Secondly, with the `?.` operator, an expression like `p?.job?.salary` will be equal to null if `salary` is equal to null, or if `job` is equal to null or if `p` is equal to null. You don't need to code a complex nested `if ... then ... else` to avoid a `NullPointerException`.

Tree Example

Consider the following example (inspired by [this](#)) where we want to calculate size, cumulative sum and cumulative product of all the values in a tree structure.

Our first attempt has special logic within the calculation methods to handle null values.

```

class NullHandlingTree {
def left, right, value

def size() {
1 + (left ? left.size() : 0) + (right ? right.size() : 0)
}

def sum() {
value + (left ? left.sum() : 0) + (right ? right.sum() : 0)
}

def product() {
value * (left ? left.product() : 1) * (right ? right.product() : 1)
}
}

def root = new NullHandlingTree(
value:2,
left: new NullHandlingTree(
value:3,
right: new NullHandlingTree(value:4),
left: new NullHandlingTree(value:5)
)
)

println root.size()
println root.sum()
println root.product()

```

If we introduce the null object pattern (here by defining the `NullTree` class), we can now simplify the logic in the `size()`, `sum()` and `product()` methods. These methods now much more clearly represent the logic for the normal (and now universal) case. Each of the methods within `NullTree` returns a value which represents doing nothing.

```

class Tree {
def left = new NullTree(), right = new NullTree(), value

def size() {
1 + left.size() + right.size()
}

def sum() {
value + left.sum() + right.sum()
}

def product() {
value * left.product() * right.product()
}
}

class NullTree {
def size() { 0 }
def sum() { 0 }
def product() { 1 }
}

def root = new Tree(
value:2,
left: new Tree(
value:3,
right: new Tree(value:4),
left: new Tree(value:5)
)
)

println root.size()

```

```
println root.sum()  
println root.product()
```

The result of running either of these examples is:

```
4  
14  
120
```

Note: a slight variation with the null object pattern is to combine it with the singleton pattern. So, we wouldn't write `new NullTree()` wherever we needed a null object as shown above. Instead we would have a single null object instance which we would place within our data structures as needed.

Pimp my Library Pattern

This page last changed on May 23, 2007 by [paulk_asert](#).

The [Pimp my Library](#) Pattern suggests an approach for extending a library that nearly does everything that you need but just needs a little more. It assumes that you do not have source code for the library of interest.

Example

Suppose we want to make use of the built-in Integer facilities in Groovy (which build upon the features already in Java). Those libraries have nearly all of the features we want but not quite everything. We may not have all of the source code to the Groovy and Java libraries so we can't just change the library. Instead we augment the library. Groovy has a number of ways to do this. One way is to use a Category.

First, we'll define a suitable category.

```
class EnhancedInteger {
    static boolean greaterThanAll(Integer self, Object[] others) {
        greaterThanAll(self, others)
    }
    static boolean greaterThanAll(Integer self, others) {
        others.every{ self > it }
    }
}
```

We have added two methods which augment the Integer methods by providing the `greaterThanAll` method. Categories follow conventions where they are defined as static methods with a special first parameter representing the class we wish to extend. The `greaterThanAll(Integer self, others)` static method becomes the `greaterThanAll(other)` instance method.

We defined two versions of `greaterThanAll`. One which works for collections, ranges etc. The other which works with a variable number of `Integer` arguments.

Here is how you would use the category.

```
use(EnhancedInteger) {
    assert 4.greaterThanAll(1, 2, 3)
    assert !5.greaterThanAll(2, 4, 6)
    assert 5.greaterThanAll(-4..4)
    assert 5.greaterThanAll([])
    assert !5.greaterThanAll([4, 5])
}
```

As you can see, using this technique you can effectively enrich an original class without having access to its source code. Moreover, you can apply different enrichments in different parts of the system as well as work with un-enriched objects if we need to.

Proxy Pattern

This page last changed on May 12, 2007 by [paulk_asert](#).

The [Proxy Pattern](#) allows one object to act as a pretend replacement for some other object. In general, whoever is using the proxy, doesn't realise that they are not using the real thing. The pattern is useful when the real object is hard to create or use: it may exist over a network connection, or be a large object in memory, or be a file, database or some other resource that is expensive or impossible to duplicate.

Example

One common use of the proxy pattern is when talking to remote objects in a different JVM. Here is the client code for creating a proxy that talks via sockets to a server object as well as an example usage:

```
class AccumulatorProxy {
  def accumulate(args) {
  def result
  def s = new Socket("localhost", 54321)
  s.withObjectStreams{ ois, oos ->
  oos << args
  result = ois.readObject()
  }
  s.close()
  return result
  }
}

println new AccumulatorProxy().accumulate([1, 2, 3, 4, 5, 6, 7, 8, 9, 10])
// => 55
```

Here is what your server code might look like (start this first):

```
class Accumulator {
  def accumulate(args) {
  args.inject(0){ total, arg -> total += arg }
  }
}

def port = 54321
def accumulator = new Accumulator()
def server = new ServerSocket(port)
println "Starting server on port $port"
while(true) {
  server.accept() { socket ->
  socket.withObjectStreams { ois, oos ->
  def args = ois.readObject()
  oos << accumulator.accumulate(args)
  }
  }
}
```

This example was inspired by this [Ruby example](#).

Singleton Pattern

This page last changed on Jul 02, 2007 by [paulk_asert](#).

The [Singleton Pattern](#) is used to make sure only one object of a particular class is ever created. This can be useful when exactly one object is needed to coordinate actions across a system; perhaps for efficiency where creating lots of identical objects would be wasteful, perhaps because a particular algorithm needing a single point of control is required or perhaps when an object is used to interact with a non-shareable resource.

Weaknesses of the Singleton pattern include:

- It can reduce reuse. For instance, there are issues if you want to use inheritance with Singletons. If `SingletonB` extends `SingletonA`, should there be exactly (at most) one instance of each or should the creation of an object from one of the classes prohibit creation from the other. Also, if you decide both classes can have an instance, how do you override the `getInstance()` method which is static?
- It is also hard to test singletons in general because of the static methods but Groovy can support that if required.

Example: The Classic Java Singleton

Suppose we wish to create a class for collecting votes. Because getting the right number of votes may be very important, we decide to use the singleton pattern. There will only ever be one `VoteCollector` object, so it makes it easier for us to reason about that objects creation and use.

```
class VoteCollector {
def votes = 0
private static final INSTANCE = new VoteCollector()
static getInstance(){ return INSTANCE }
private VoteCollector() {}
def display() { println "Collector:${hashCode()}, Votes:$votes" }
}
```

Some points of interest about this code:

- it has a private constructor, so no `VoteCollector` objects can be created in our system (except for the `INSTANCE` we create)
- the `INSTANCE` is also private, so it can't be changed once set
- we haven't made the updating of votes thread-safe at this point (it doesn't add to this example)
- the vote collector instance is not lazily created (if we never reference the class, the instance won't be created; however, as soon as we reference the class, the instance will be created even if not needed initially)

We can use this singleton class in some script code as follows:

```
def collector = VoteCollector.instance
collector.display()
collector.votes++
collector = null

Thread.start{
def collector2 = VoteCollector.instance
collector2.display()
collector2.votes++
collector2 = null
}.join()

def collector3 = VoteCollector.instance
collector3.display()
```

Here we used the instance 3 times. The second usage was even in a different thread (but don't try this in a scenario with a new class loader).

Running this script yields (your hashcode value will vary):

```
Collector:15959960, Votes:0
Collector:15959960, Votes:1
```

Collector:15959960, Votes:2

Variations to this pattern:

- To support lazy-loading and multi-threading, we could just use the `synchronized` keyword with the `getInstance()` method. This has a performance hit but will work.
- We can consider variations involving double-checked locking and the `volatile` keyword (for Java 5 and above), but see the limitations of this approach [here](#).

Example: Singleton via MetaProgramming

Groovy's meta-programming capabilities allow concepts like the singleton pattern to be enacted in a far more fundamental way. This example illustrates a simple way to use Groovy's meta-programming capabilities to achieve the singleton pattern but not necessarily the most efficient way.

Suppose we want to keep track of the total number of calculations that a calculator performs. One way to do that is to use a singleton for the calculator class and keep a variable in the class with the count.

First we define some base classes. A `Calculator` class which performs calculations and records how many such calculations it performs and a `Client` class which acts as a facade to the calculator.

```
class Calculator {
private total = 0
def add(a, b) { total++; a + b }
def getTotalCalculations() { 'Total Calculations: ' + total }
String toString() { 'Calc: ' + hashCode()}
}
```

```
class Client {
def calc = new Calculator()
def executeCalc(a, b) { calc.add(a, b) }
String toString() { 'Client: ' + hashCode()}
}
```

Now we can define and register a *MetaClass* which intercepts all attempts to create a `Calculator` object and always provides a pre-created instance instead. We also register this *MetaClass* with the Groovy system:

```
class CalculatorMetaClass extends MetaClassImpl {
private final static INSTANCE = new Calculator()
CalculatorMetaClass() { super(Calculator) }
def invokeConstructor(Object[] arguments) { return INSTANCE }
}
```

```
def registry = GroovySystem.metaClassRegistry
registry.setMetaClass(Calculator, new CalculatorMetaClass())
```

Now we use instances of our `Client` class from within a script. The client class will attempt to create new instances of the calculator but will always get the singleton.

```
def client = new Client()
assert 3 == client.executeCalc(1, 2)
println "$client, $client.calc, $client.calc.totalCalculations"

client = new Client()
assert 4 == client.executeCalc(2, 2)
println "$client, $client.calc, $client.calc.totalCalculations"
```

Here is the result of running this script (your hashcode values may vary):

```
Client: 7306473, Calc: 24230857, Total Calculations: 1
Client: 31436753, Calc: 24230857, Total Calculations: 2
```

Guice Example

We can also implement the Singleton Pattern using [Guice](#). This example relies on annotations. Annotations are a Groovy 1.1 feature and will need to be run on a Java 5 or above JVM.

Consider the Calculator example again.

Guice is a Java-oriented framework that supports Interface-Oriented design. Hence we create a `Calculator` interface first. We can then create our `CalculatorImpl` implementation and a `Client` object which our script will interact with. The `Client` class isn't strictly needed for this example but allows us to show that non-singleton instances are the default. Here is the code:

```
// require(groupId:'aopalliance', artifactId:'aopalliance', version:'1.0')
// require(groupId:'com.google.code.guice', artifactId:'guice', version:'1.0')

import com.google.inject.*

interface Calculator {
def add(a, b)
}

class CalculatorImpl implements Calculator {
private total = 0
def add(a, b) { total++; a + b }
def getTotalCalculations() { 'Total Calculations: ' + total }
String toString() { 'Calc: ' + hashCode()}
}

class Client {
@Inject Calculator calc
def executeCalc(a, b) { calc.add(a, b) }
String toString() { 'Client: ' + hashCode()}
}

def injector = Guice.createInjector (
[configure: { binding ->
binding.bind(Calculator)
.to(CalculatorImpl)
.asEagerSingleton() } ] as Module
)

client = injector.getInstance(Client)
assert 3 == client.executeCalc(1, 2)
println "$client, $client.calc, $client.calc.totalCalculations"

client = injector.getInstance(Client)
assert 4 == client.executeCalc(2, 2)
println "$client, $client.calc, $client.calc.totalCalculations"
```

Note the `@Inject` annotation in the `Client` class. We can always tell right in the source code which fields will be injected.

In this example we chose to use an *explicit* binding. All of our dependencies (ok, only one in this example at the moment) are configured in the binding. The Guice injector knows about the binding and injects the dependencies as required when we create objects. For the singleton pattern to hold, you must always use Guice to create your instances. Nothing shown so far would stop you creating another instance of the calculator manually using `new CalculatorImpl()` which would of course violate the desired singleton behaviour.

In other scenarios (though probably not in large systems), we could choose to express dependencies using annotations, such as the following example shows:

```
import com.google.inject.*

@ImplementedBy(CalculatorImpl)
interface Calculator {
```

```

// as before ...
}

@Singleton
class CalculatorImpl implements Calculator {
// as before ...
}

class Client {
// as before ...
}

def injector = Guice.createInjector()

// ...

```

Note the `@Singleton` annotation on the `CalculatorImpl` class and the `@ImplementedBy` annotation in the `Calculator` interface.

When run, the above example (using either approach) yields (your hashcode values will vary):

```

Client: 8897128, Calc: 17431955, Total Calculations: 1
Client: 21145613, Calc: 17431955, Total Calculations: 2

```

You can see that we obtained a new client object whenever we asked for an instance but it was injected with the same calculator object.

Spring Example

We can do the Calculator example again using Spring as follows:

```

// require(groupId:'org.springframework', artifactId:'spring-core', version:'2.1ml')
// require(groupId:'org.springframework', artifactId:'spring-beans', version:'2.1ml')

import org.springframework.beans.factory.support.*

interface Calculator {
def add(a, b)
}

class CalculatorImpl implements Calculator {
private total = 0
def add(a, b) { total++; a + b }
def getTotalCalculations() { 'Total Calculations: ' + total }
String toString() { 'Calc: ' + hashCode()}
}

class Client {
Client(Calculator calc) { this.calc = calc }
def calc
def executeCalc(a, b) { calc.add(a, b) }
String toString() { 'Client: ' + hashCode()}
}

// Here we 'wire' up our dependencies through the API. Alternatively,
// we could use XML-based configuration or the Grails Bean Builder DSL.
def factory = new DefaultListableBeanFactory()
factory.registerBeanDefinition('calc', new RootBeanDefinition(CalculatorImpl))
def beanDef = new RootBeanDefinition(Client, false)
beanDef.setAutowireMode(AbstractBeanDefinition.AUTOWIRE_AUTODETECT)
factory.registerBeanDefinition('client', beanDef)

client = factory.getBean('client')
assert 3 == client.executeCalc(1, 2)
println "$client, $client.calc, $client.calc.totalCalculations"

```



```
client = factory.getBean('client')
assert 4 == client.executeCalc(2, 2)
println "$client, $client.calc, $client.calc.totalCalculations"
```

And here is the result (your hashCode values will vary):

```
Client: 29418586, Calc: 10580099, Total Calculations: 1
Client: 14800362, Calc: 10580099, Total Calculations: 2
```

Further information

- [Simply Singleton](#)
- [Use your singletons wisely](#)
- [Double-checked locking and the Singleton pattern](#)
- [Lazy Loading Singletons](#)
- [Implementing the Singleton Pattern in C#](#)

State Pattern

This page last changed on Dec 08, 2007 by [paulk_asert](#).

The [State Pattern](#) provides a structured approach to partitioning the behaviour within complex systems. The overall behaviour of a system is partitioned into well-defined states. Typically, each state is implemented by a class. The overall system behaviour can be determined firstly by knowing the *current state* of the system; secondly, by understanding the behaviour possible while in that state (as embodied in the methods of the class corresponding to that state).

Example

Here is an example:

```
class Client {
  def context = new Context()
  def connect() {
    context.state.connect()
  }
  def disconnect() {
    context.state.disconnect()
  }
  def send_message(message) {
    context.state.send_message(message)
  }
  def receive_message() {
    context.state.receive_message()
  }
}

class Context {
  def state = new Offline(this)
}

class ClientState {
  def context
  ClientState(context) {
    this.context = context
    inform()
  }
}

class Offline extends ClientState {
  Offline(context) {
    super(context)
  }
  def inform() {
    println "offline"
  }
  def connect() {
    context.state = new Online(context)
  }
  def disconnect() {
    println "error: not connected"
  }
  def send_message(message) {
    println "error: not connected"
  }
  def receive_message() {
    println "error: not connected"
  }
}

class Online extends ClientState {
  Online(context) {
    super(context)
  }
}
```

```

}
def inform() {
println "connected"
}
def connect() {
println "error: already connected"
}
def disconnect() {
context.state = new Offline(context)
}
def send_message(message) {
println "\"$message\" sent"
}
def receive_message() {
println "message received"
}
}

client = new Client()
client.send_message("Hello")
client.connect()
client.send_message("Hello")
client.connect()
client.receive_message()
client.disconnect()

```

Here is the output:

```

offline
error: not connected
connected
"Hello" sent
error: already connected
message received
offline

```

This example was inspired from a similar [Ruby Example](#). One of the great things about a dynamic language like Groovy though is that we can take this example and express it in many different ways depending on our particular needs. Some potential variations for this example are shown below.

Variation 1: Leveraging Interface-Oriented Design

One approach we could take is to leverage [Interface-Oriented Design](#). To do this, we could introduce the following interface:

```

interface State {
def connect()
def disconnect()
def send_message(message)
def receive_message()
}

```

Then our `Client`, `Online` and `Offline` classes could be modified to implement that interface, e.g.:

```

class Client implements State {
// ... as before ...
}

```

```

class Online implements State {

```

```
// ... as before ...  
}
```

You might ask: Haven't we just introduced additional boilerplate code? Can't we rely on duck-typing for this? The answer is 'yes' and 'no'. We can get away with duck-typing but one of the key intentions of the state pattern is to partition complexity. If we know that the *client* class and each *state* class all satisfy one interface, then we have placed some key boundaries around the complexity. We can look at any state class in isolation and know the bounds of behaviour possible for that state.

We don't have to use interfaces for this, but it helps express the intent of this particular style of partitioning and it helps reduce the size of our unit tests (we would have to have additional tests in place to express this intent in languages which have less support for interface-oriented design).

Variation 2: Extract State Pattern Logic

Alternatively, or in combination with other variations, we might decide to extract some of our State Pattern logic into helper classes. For example, we could define the following classes in a state pattern package/jar/script:

```
abstract class InstanceProvider {  
    static def registry = GroovySystem.metaClassRegistry  
    static def create(objectClass, param) {  
        registry.getMetaClass(objectClass).invokeConstructor([param] as Object[])  
    }  
}  
  
abstract class Context {  
    private context  
    protected setContext(context) {  
        this.context = context  
    }  
    def invokeMethod(String name, Object arg) {  
        context.invokeMethod(name, arg)  
    }  
    def startFrom(initialState) {  
        setContext(InstanceProvider.create(initialState, this))  
    }  
}  
  
abstract class State {  
    private client  
  
    State(client) { this.client = client }  
  
    def transitionTo(nextState) {  
        client.setContext(InstanceProvider.create(nextState, client))  
    }  
}
```

This is all quite generic and can be used wherever we want to introduce the state pattern. Here is what our code would look like now:

```
class Client extends Context {  
    Client() {  
        startFrom(Offline)  
    }  
}  
  
class Offline extends State {  
    Offline(client) {  
        super(client)  
        println "offline"  
    }  
}
```

```

def connect() {
transitionTo(Online)
}
def disconnect() {
println "error: not connected"
}
def send_message(message) {
println "error: not connected"
}
def receive_message() {
println "error: not connected"
}
}

class Online extends State {
Online(client) {
super(client)
println "connected"
}
def connect(){
println "error: already connected"
}
def disconnect(){
transitionTo(Offline)
}
def send_message(message) {
println "\"$message\" sent"
}
def receive_message(){
println "message received"
}
}

client = new Client()
client.send_message("Hello")
client.connect()
client.send_message("Hello")
client.connect()
client.receive_message()
client.disconnect()

```

You can see here the `startFrom` and `transitionTo` methods begin to give our example code a DSL feel.

Variation 3: Bring on the DSL

Alternatively, or in combination with other variations, we might decide to fully embrace a Domain Specific Language (DSL) approach to this example.

We can define the following generic helper functions (first discussed [here](#)):

```

class Grammar {
def fsm

def event
def fromState
def toState

Grammar(a_fsm) {
fsm = a_fsm
}

def on(a_event) {
event = a_event
this
}
}

```

```

def on(a_event, a_transitioner) {
  on(a_event)
  a_transitioner.delegate = this
  a_transitioner.call()
  this
}

def from(a_fromState) {
  fromState = a_fromState
  this
}

def to(a_toState) {
  assert a_toState, "Invalid toState: $a_toState"
  toState = a_toState
  fsm.registerTransition(this)
  this
}

def isValid() {
  event && fromState && toState
}

public String toString() {
  "$event: $fromState=>$toState"
}

}

class FiniteStateMachine {
  def transitions = [:]

  def initialState
  def currentState

  FiniteStateMachine(a_initialState) {
    assert a_initialState, "You need to provide an initial state"
    initialState = a_initialState
    currentState = a_initialState
  }

  def record() {
    Grammar.newInstance(this)
  }

  def reset() {
    currentState = initialState
  }

  def isState(a_state) {
    currentState == a_state
  }

  def registerTransition(a_grammar) {
    assert a_grammar.isValid(), "Invalid transition ($a_grammar)"
    def transition
    def event = a_grammar.event
    def fromState = a_grammar.fromState
    def toState = a_grammar.toState

    if (!transitions[event]) {
      transitions[event] = [:]
    }

    transition = transitions[event]

```

```

assert !transition[fromState], "Duplicate fromState $fromState for transition $a_grammar"
transition[fromState] = toState
}

def fire(a_event) {
assert currentState, "Invalid current state '$currentState': passed into constructor"
assert transitions.containsKey(a_event), "Invalid event '$a_event', should be one of
${transitions.keySet()}"
def transition = transitions[a_event]
def nextState = transition[currentState]
assert nextState, "There is no transition from '$currentState' to any other state"
currentState = nextState
currentState
}
}

```

Now we can define and test our state machine like this:

```

class StatePatternDslTest extends GroovyTestCase {
private fsm

protected void setUp() {
fsm = FiniteStateMachine.newInstance('offline')
def recorder = fsm.record()
recorder.on('connect').from('offline').to('online')
recorder.on('disconnect').from('online').to('offline')
recorder.on('send_message').from('online').to('online')
recorder.on('receive_message').from('online').to('online')
}

void testInitialState() {
assert fsm.isState('offline')
}

void testOfflineState() {
shouldFail{
fsm.fire('send_message')
}
shouldFail{
fsm.fire('receive_message')
}
shouldFail{
fsm.fire('disconnect')
}
assert 'online' == fsm.fire('connect')
}

void testOnlineState() {
fsm.fire('connect')
fsm.fire('send_message')
fsm.fire('receive_message')
shouldFail{
fsm.fire('connect')
}
assert 'offline' == fsm.fire('disconnect')
}
}

```

This example isn't an exact equivalent of the others. It doesn't use predefined `Online` and `Offline` classes. Instead it defines the entire state machine on the fly as needed. See the [previous reference](#) for more elaborate examples of this style.

See also: [Model-based testing using ModelJUnit](#)

Strategy Pattern

This page last changed on May 07, 2007 by paulk_asert.

The [Strategy Pattern](#) allows you to abstract away particular algorithms from their usage. This allows you to easily swap the algorithm being used without having to change the calling code. The general form of the pattern is:

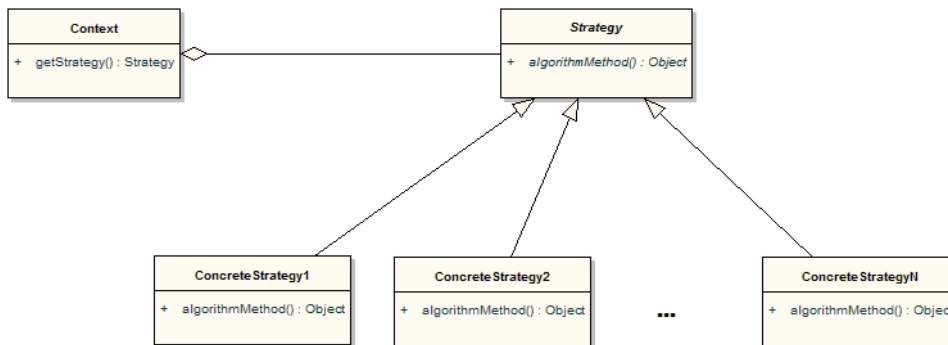

In Groovy, because of its ability to treat code as a first class object using anonymous methods (which we loosely call *Closures*), the need for the strategy pattern is greatly reduced. You can simply place algorithms inside Closures.

Example

First let's look at the traditional way of encapsulating the Strategy Pattern.

```
interface Calc {
    def execute(n, m)
}

class CalcByMult implements Calc {
    def execute(n, m) { n * m }
}

class CalcByManyAdds implements Calc {
    def execute(n, m) {
        def result = 0
        n.times{
            result += m
        }
        return result
    }
}

def sampleData = [
    [3, 4, 12],
    [5, -5, -25]
]

Calc[] multiplicationStrategies = [
    new CalcByMult(),
    new CalcByManyAdds()
]

sampleData.each{ data ->
    multiplicationStrategies.each{ calc ->
        assert data[2] == calc.execute(data[0], data[1])
    }
}
```

Here we have defined an interface `Calc` which our concrete strategy classes will implement (we could also have used an abstract class). We then defined two algorithms for doing simple multiplication: `CalcByMult`

the normal way, and `CalcByManyAdds` using only addition (don't try this one using negative numbers - yes we could fix this but it would just make the example longer). We then use normal [polymorphism](#) to invoke the algorithms.

Here is the Groovier way to achieve the same thing using Closures:

```
def multiplicationStrategies = [
  { n, m -> n * m },
  { n, m -> def result = 0; n.times{ result += m }; result }
]

def sampleData = [
  [3, 4, 12],
  [5, -5, -25]
]

sampleData.each{ data ->
  multiplicationStrategies.each{ calc ->
    assert data[2] == calc(data[0], data[1])
  }
}
```

Template Method Pattern

This page last changed on May 07, 2007 by paulk_asert.

The [Template Method Pattern](#) abstracts away the details of several algorithms. The generic part of an algorithm is contained within a base class. Particular implementation details are captured within base classes. The generic pattern of classes involved looks like this:

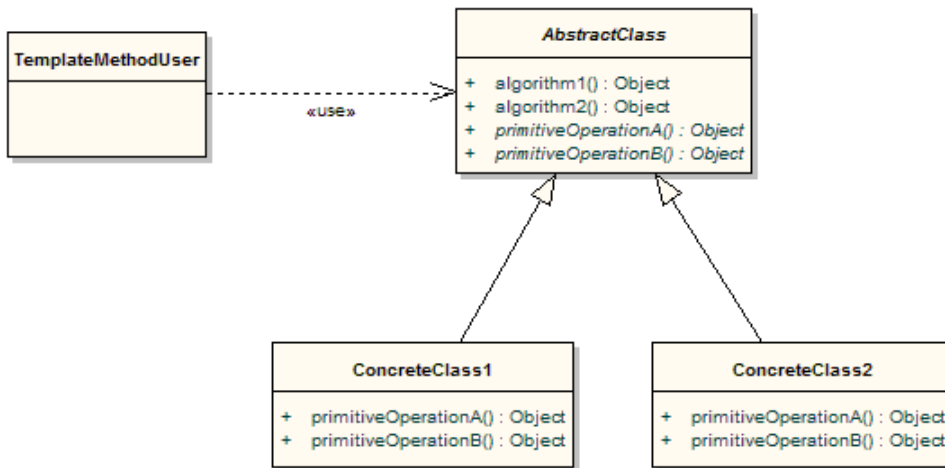

Example

In this example, `Accumulator` captures the essence of the accumulation algorithm. The base classes `Sum` and `Product` provide particular customised ways to use the generic accumulation algorithm.

```
abstract class Accumulator {
    protected initial
    abstract doAccumulate(total, v)
    def accumulate(values) {
        def total = initial
        values.each { v -> total = doAccumulate(total, v) }
        total
    }
}

class Sum extends Accumulator {
    def Sum() { initial = 0 }
    def doAccumulate(total, v) { total + v }
}

class Product extends Accumulator {
    def Product() { initial = 1 }
    def doAccumulate(total, v) { total * v }
}

println new Sum().accumulate([1,2,3,4])
println new Product().accumulate([1,2,3,4])
```

The resulting output is:

```
10
24
```

In this particular case, you could use Groovy's `inject` method to achieve a similar result using Closures:

```
Closure addAll = { total, item -> total += item }
def accumulated = [1, 2, 3, 4].inject(0, addAll)
println accumulated // => 10
```

Thanks to duck-typing, this would also work with other objects which support an add (`plus()` in Groovy) method, e.g.:

```
accumulated = ["1", "2", "3", "4"].inject("", addAll)
println accumulated // => "1234"
```

We could also do the multiplication case as follows:

```
Closure multAll = { total, item -> total *= item }
accumulated = [1, 2, 3, 4].inject(1, multAll)
println accumulated // => 24
```

Using closures this way looks more like the [Strategy Pattern](#) but if we realise that the built-in `inject` method is the generic part of the algorithm for our template method, then the Closures become the customised parts of the template method pattern.

Visitor Pattern

This page last changed on Jul 03, 2007 by [jamel](#).

The [Visitor Pattern](#) is one of those well-known but not often used patterns. I think this is strange, as it is really a nice thing.

The goal of the pattern is to separate an algorithm from an object structure. A practical result of this separation is the ability to add new operations to existing object structures without modifying those structures.

Simple Example

This example (inspired by [this](#)) considers how to calculate the bounds of shapes (or collections of shapes). Our first attempt uses the traditional visitor pattern. We will see a more Groovy way to do this shortly.

```
abstract class Shape { }

class Rectangle extends Shape {
def x, y, width, height

Rectangle(x, y, width, height) {
this.x = x; this.y = y; this.width = width; this.height = height
}

def union(rect) {
if (!rect) return this
def minx = [rect.x, x].min()
def maxx = [rect.x + width, x + width].max()
def miny = [rect.y, y].min()
def maxy = [rect.y + height, y + height].max()
new Rectangle(minx, miny, maxx - minx, maxy - miny)
}

def accept(visitor) {
visitor.visit_rectangle(this)
}
}

class Line extends Shape {
def x1, y1, x2, y2

Line(x1, y1, x2, y2) {
this.x1 = x1; this.y1 = y1; this.x2 = x2; this.y2 = y2
}

def accept(visitor){
visitor.visit_line(this)
}
}

class Group extends Shape {
def shapes = []
def add(shape) { shapes += shape }
def remove(shape) { shapes -= shape }
def accept(visitor) {
visitor.visit_group(this)
}
}

class BoundingRectangleVisitor {
def bounds

def visit_rectangle(rectangle) {
if (bounds)
```

```

bounds = bounds.union(rectangle)
else
bounds = rectangle
}

def visit_line(line) {
def line_bounds = new Rectangle(line.x1, line.y1, line.x2-line.y1, line.x2-line.y2)
if (bounds)
bounds = bounds.union(line_bounds)
else
bounds = line_bounds
}

def visit_group(group) {
group.shapes.each { shape -> shape.accept(this) }
}
}

def group = new Group()
group.add(new Rectangle(100, 40, 10, 5))
group.add(new Rectangle(100, 70, 10, 5))
group.add(new Line(90, 30, 60, 5))
def visitor = new BoundingRectangleVisitor()
group.accept(visitor)
bounding_box = visitor.bounds
println bounding_box.dump()

```

That took quite a bit of code.

We can improve the clarity of our code (and make it about half the size) by making use of Groovy Closures as follows:

```

abstract class Shape {
def accept(Closure yield) { yield(this) }
}

class Rectangle extends Shape {
def x, y, w, h
def bounds() { this }
def union(rect) {
if (!rect) return this
def minx = [rect.x, x].min()
def maxx = [rect.x + w, x + w].max()
def miny = [rect.y, y].min()
def maxy = [rect.y + h, y + h].max()
new Rectangle(x:minx, y:miny, w:maxx - minx, h:maxy - miny)
}
}

class Line extends Shape {
def x1, y1, x2, y2
def bounds() {
new Rectangle(x:x1, y:y1, w:x2-y1, h:x2-y2)
}
}

class Group {
def shapes = []
def leftShift(shape) { shapes += shape }
def accept(Closure yield) { shapes.each{it.accept(yield)} }
}

def group = new Group()
group << new Rectangle(x:100, y:40, w:10, h:5)
group << new Rectangle(x:100, y:70, w:10, h:5)
group << new Line(x1:90, y1:30, x2:60, y2:5)

```

```

def bounds
group.accept{ bounds = it.bounds().union(bounds) }
println bounds.dump()

```

Advanced Example

```

interface Visitor {
public void visit(NodeType1 n1);
public void visit(NodeType2 n2);
}

interface Visitable {
public void accept(Visitor visitor);
}

class NodeType1 implements Visitable {
Visitable[] children = new Visitable[0];
public void accept(Visitor visitor) {
visitor.visit(this);
for(int i = 0; i < children.length; ++i) {
children[i].accept(visitor);
}
}
}

class NodeType2 implements Visitable {
Visitable[] children = new Visitable[0];
public void accept(Visitor visitor) {
visitor.visit(this);
for(int i = 0; i < children.length; ++i) {
children[i].accept(visitor);
}
}
}

public class NodeType1Counter implements Visitor {
int count = 0;
public void visit(NodeType1 n1) {
count++;
}
public void visit(NodeType2 n2){}
}

```

If we now use `NodeType1Counter` on a tree like this:

```

NodeType1 root = new NodeType1()
root.children = new Visitable[2];
root.children[0] = new NodeType1();
root.children[1] = new NodeType2();

```

Then we have one `NodeType1` object as root and one of the children is also a `NodeType1` instance. The other child is a `NodeType2` instance. That means using `NodeType1Counter` here should count 2 `NodeType1` objects.

Why to use this

As you can see here very good we have a visitor that has a state while the tree of objects is not changed. That's pretty useful in different areas, for example you could have a visitor counting all node types, or how many different types are used, or you could use methods special to the node to gather information about the tree and much more.

What happens if we add a new type?

In this case we have to do much work.. we have to change Visitor to accept the new type, we have to write the new type itself of course and we have to change every Visitor we have already implemented. After very few changes you will modify all your Visitors to extend a default implementation of the visitor, so you don't need to change every Visitor each time you add a new type.

What if we want to have different iteration patterns?

Then you have a problem. since the node describes how to iterate, you have no influence and stop iteration at a point or change the order. so maybe we should change this a little to this:

```
interface Visitor {
public void visit(NodeType1 n1);
public void visit(NodeType2 n2);
}

class DefaultVisitor implements Visitor{
public void visit(NodeType1 n1) {
for(int i = 0; i < n1.children.length; ++i) {
n1.children[i].accept(visitor);
}
}
public void visit(NodeType2 n2) {
for(int i = 0; i < n2.children.length; ++i) {
n2.children[i].accept(visitor);
}
}
}

interface Visitable {
public void accept(Visitor visitor);
}

class NodeType1 implements Visitable {
Visitable[] children = new Visitable[0];
public void accept(Visitor visitor) {
visitor.visit(this);
}
}

class NodeType2 implements Visitable {
Visitable[] children = new Visitable[0];
public void accept(Visitor visitor) {
visitor.visit(this);
}
}

public class NodeType1Counter extends DefaultVisitor {
int count = 0;
public void visit(NodeType1 n1) {
count++;
super.visit(n1);
}
}
```

Some small changes but with big effect... the visitor is now recursive and tells me how to iterate. The implementation in the Nodes is minimized to visitor.visit(this);, DefaultVisitor is now able to catch the new types, we can stop iteration by not delegating to super. Of course the big disadvantage now is that it is no longer iterative, but you can't get all the benefits.

Make it Groovy

The question now is how to make that a bit more Groovy. Didn't you find this `visitor.visit(this);` strange? Why is it there? The answer is to simulate double dispatch. In Java the compile time type is used, so when I `visitor.visit(children[i]);` then the compiler won't be able to find the correct method, because Visitor does not contain a method `visit(Visitable)`. And even if it would, we would like to visit the more special methods with `NodeType1` or `NodeType2`.

Now Groovy is not using the static type, Groovy uses the runtime type. This means I could do `visitor.visit(children[i])` directly. Hmm.. since we minimized the accept method to just do the double dispatch part and since the runtime type system of Groovy will already cover that.. do we need the accept method? I think you can guess that I would answer no. But we can do more. We had the disadvantage of not knowing how to handle unknown tree elements. We had to extend the interface Visitor for that, resulting in changes to DefaultVisitor and then we have the task to provide a useful default like iterating the node or not doing anything at all. Now with Groovy we can catch that case by adding a `visit(Visitable)` method that does nothing. that would be the same in Java btw.

But don't let us stop here... do we need the Visitor interface? If we don't have the accept method, then we don't need the Visitor interface at all. So the new code would be:

```
class DefaultVisitor {
void visit(NodeType1 n1) {
n1.children.each { visit(it) }
}
void visit(NodeType2 n2) {
n2.children.each { visit(it) }
}
void visit(Visitable v) {}
}

interface Visitable {}

class NodeType1 implements Visitable {
Visitable[] children = []
}

class NodeType2 implements Visitable {
Visitable[] children = []
}

public class NodeType1Counter extends DefaultVisitor {
int count = 0;
public void visit(NodeType1 n1) {
count++
super.visit(n1)
}
}
```

Looks like we saved a few lines of code here. But we made more. The Visitable nodes now do not refer to any Visitor class or interface. For me this is the best level of separation you could get here. But do we really need to stop here? No. Let us change the Visitable interface a little and let it return the children we want to visit next. This allows us a general iteration method.

```
class DefaultVisitor {
void visit(Visitable v) {
doIteration(v)
}
doIteration(Visitable v) {
v.children.each { visit(it) }
}
}

interface Visitable {
Visitable[] getChildren()
}
```



```

class NodeType1 implements Visitable {
    Visitable[] children = []
}

class NodeType2 implements Visitable {
    Visitable[] children = []
}

public class NodeType1Counter extends DefaultVisitor {
    int count = 0
    public void visit(NodeType1 n1) {
        count++
        super.visit(n1)
    }
}

```

DefaultVisitor now looks a bit different. I added a `doIterate` method that will get the children it should iterate over and then call `visit` on each element. Per default this will call `visit(Visitable)}` which then iterates over the children of this child. I changed `Visitable` to ensure that any node will be able to return children (even if empty). I didn't have to change the `NodeType1` and `NodeType2` class, because the way the children field was defined already made them a property, which means Groovy is so nice to generate a `get` method for us. No the really interesting part is `NodeType1Counter`, it is interesting because we have not changed it. `{super.visit(n1) will now call visit(Visitable)}` which will call `doIterate` which will start the next level of iteration. So no change. But `visit(it)` will call `visit(NodeType1)` if it is of type `NodeType1`. In fact we don't need the `doIterate` method, we could do that in `{visit(Visitable) too, but I thought this variant is better, because it allows us to write a new Visitor that overwrites visit(Visitable) for error cases which of course means we must not do super.visit(n1) but doIterate(n1).`

Summary

In the end we got ~40% less code, a robust and stable architecture and we completely removed the Visitor from the Visitable. I heard about visitor implementations based on Reflection to get a more generic version. Well, with this you see there is really no need to do such thing. If we add new types we don't need to change anything. It is said that the visitor pattern doesn't fit extreme programming techniques very well because you need to make changes to so many classes all the time. I think I proved that this is because of Java not because the pattern is bad or something.

There are variants of the Visitor pattern, like the acyclic visitor pattern, that tries to solve the problem of adding new node types with special visitors. I don't like that very much, it works with casts, catches the `ClassCastException` and other nasty things. In the end it tries to solve something we don't even get with the Groovy version.

One more thing. `NodeType1Counter` could be implemented in Java as well. Groovy will recognize the visit methods and call them as needed because `DefaultVisitor` is still Groovy and does all the magic.

Further Information

1. [Componentization: the Visitor example](#)

Dynamic language beans in Spring

This page last changed on Jun 02, 2007 by paulk_asert.

Background

The [Spring Framework](#) is a leading full-stack Java/J2EE application framework. It is aimed primarily at Java projects and delivers significant benefits such as reducing development effort and costs while providing facilities to improve test coverage and quality. It also has mechanisms for allowing beans to be backed by dynamic language code including Groovy and other languages.

Let's have a look at how to use Spring's support for writing dynamic language backed beans to extend an existing Java application. The existing Java application prints out information about countries in sorted order. We want to be able to add new countries and new sorting algorithms but using different languages for each one. Our goal is to not have to change the original Java code but add the new features just through the application wiring.

The Existing Application (Spring and Java)

Suppose we have the following interface:

```
package spring;

public interface Country {
    long getPopulation();
    String getCapital();
}
```

And the following implementation class:

```
package spring;

public class USA implements Country {
    private final String capital;
    private final long population;

    public USA(String capital, long population) {
        this.population = population;
        this.capital = capital;
    }

    public String toString() {
        return "USA[Capital=" + capital + ", Population=" + population + "];"
    }

    public long getPopulation() {
        return population;
    }

    public String getCapital() {
        return capital;
    }
}
```

Spring supports the [Dependency Injection](#) style of coding. This style encourages classes which depend on classes like USA not to hard-code that dependency, e.g. no fragments of code like 'new USA(...)' and no 'import ...USA;'. Such a style allows us to change the concrete implementations we depend on for testing purposes or at a future point in time as our program evolves. In our example above, we might declaratively state our dependencies in a beans.xml file as follows:

```
<?xml version="1.0" encoding="UTF-8"?>
<beans xmlns="http://www.springframework.org/schema/beans" xmlns:xsi="http://www.w3.org/2001/
XMLSchema-instance"
xmlns:lang="http://www.springframework.org/schema/lang"
xsi:schemaLocation="
```

```

http://www.springframework.org/schema/beans http://www.springframework.org/schema/beans/spring-
beans-2.0.xsd
http://www.springframework.org/schema/lang http://www.springframework.org/schema/lang/spring-
lang-2.0.xsd">
<bean id="usa" class="spring.USA">
<constructor-arg value="Washington, D.C."/>
<constructor-arg value="298444215"/>
</bean>
</beans>

```

In this example, the `<constructor-arg/>` element allows us to use constructor-based injection.

Having done this, we can get access to our beans through a variety of mechanisms. Normally, access to the beans is mostly transparent. In our case though, we are going to make access explicit so you can see what is going on. Our main method might look like this:

```

package spring;

import org.springframework.context.ApplicationContext;
import org.springframework.context.support.ClassPathXmlApplicationContext;

import java.util.Arrays;

public class SortMain {
public static void main(String[] args) {
try {
ApplicationContext ctx = new ClassPathXmlApplicationContext("beans.xml");
Country usa = (Country) ctx.getBean("usa");
System.out.println("USA Info:\n" + usa);
} catch (Exception e) {
e.printStackTrace();
}
}
}

```

Running this results in:

```

USA Info:
USA[Capital=Washington, D.C., Population=298444215]

```

Spring and Groovy

We can extend this example and introduce Groovy in a number of ways. Firstly, we can create the following Groovy class:

```

package spring
public class Australia implements Country {
String capital
long population
String toString() {
return "Australia[Capital=" + capital + ", Population=" + population + "]"
}
}

```

And this one too:

```

package spring
public class NewZealand extends Australia implements Country {
String toString() {
return "NewZealand[Capital=" + capital + ", Population=" + population + "]"
}
}

```

So long as the corresponding `.class` file is available on the classpath (e.g. by your IDE or by manually running `groovyc`), we can simply reference this class in our `beans.xml` file. E.g. for the first class we can use:

```

...
<bean id="country1" class="spring.Australia">
<property name="capital" value="Canberra"/>
<property name="population" value="20264082"/>
</bean>
...

```

Alternatively, if the source file is on the classpath, we can use special Spring notation to reference it, e.g. for the second class we can use:

```

...
<lang:groovy id="country3" script-source="classpath:spring/NewZealand.groovy">
<lang:property name="capital" value="Wellington" />
<lang:property name="population" value="4076140" />
</lang:groovy>
...

```

In these examples, the `<property/>` and `<lang:property/>` elements allows us to use setter-based injection.

Spring and JRuby

If we prefer to code in another language (with a few restrictions - see below), Spring supports other languages too, e.g.:

```

require 'java'

include_class 'spring.Country'

class Fiji < Country
def getCapital()
@capital
end
def getPopulation()
@population
end
def setCapital(capital)
@capital = capital
end
def setPopulation(population)
@population = population
end
def to_s()
"Fiji[Capital=" + @capital + ", Population=" + getPopulation().to_s() + "]"
end
end
Fiji.new()

...
<lang:jruby id="country4" script-interfaces="spring.Country" script-source="classpath:spring/
Fiji.rb">
<lang:property name="capital" value="Suva" />
<lang:property name="population" value="905949" />
</lang:jruby>
...

```

Spring and Groovy Again

But wait there's more ...

Suppose now that we wish to sort our countries according to population size. We don't want to use Java's built-in sort mechanisms as some of them rely on our objects implementing the `Comparable` interface and we don't want that noise in our Ruby script. Instead we will use Groovy. We could simply write a `Sort` class in Groovy and reference as we have done above. This time however we are going to use

an additional Spring feature and have the scripting code within our `beans.xml` file. First we define the following Java interface:

```
package spring;

import java.util.List;

public interface Sorter {
    List sort(Country[] unsorted);
}
```

We can then include the Groovy sort code directly into the `beans.xml` file as follows:

```
...
<lang:groovy id="sorter">
<lang:inline-script><![CDATA[
package spring
class CountrySorter implements Sorter {
    String order
    List sort(Country[] items) {
    List result = items.toList().sort{ p1, p2 -> p1.population <=> p2.population }
    if (order == "reverse") return result.reverse() else return result
    }
    }
    ]]></lang:inline-script>
<lang:property name="order" value="forward" />
</lang:groovy>
...
```

Putting it all together

We now combine all of the approaches above in a final example.

Here is the complete `beans.xml` file:

```
<?xml version="1.0" encoding="UTF-8"?>
<beans xmlns="http://www.springframework.org/schema/beans" xmlns:xsi="http://www.w3.org/2001/
XMLSchema-instance"
xmlns:lang="http://www.springframework.org/schema/lang"
xsi:schemaLocation="
http://www.springframework.org/schema/beans http://www.springframework.org/schema/beans/spring-
beans-2.0.xsd
http://www.springframework.org/schema/lang http://www.springframework.org/schema/lang/spring-
lang-2.0.xsd">
<bean id="country1" class="spring.Australia">
<property name="capital" value="Canberra"/>
<property name="population" value="20264082"/>
</bean>
<bean id="country2" class="spring.USA">
<constructor-arg value="Washington, D.C." />
<constructor-arg value="298444215" />
</bean>
<lang:groovy id="country3" script-source="classpath:spring/NewZealand.groovy">
<lang:property name="capital" value="Wellington" />
<lang:property name="population" value="4076140" />
</lang:groovy>
<lang:jruby id="country4" script-interfaces="spring.Country" script-source="classpath:spring/
Fiji.rb">
<lang:property name="capital" value="Suva" />
<lang:property name="population" value="905949" />
</lang:jruby>
<lang:groovy id="sorter">
<lang:inline-script><![CDATA[
package spring
class CountrySorter implements Sorter {
    String order
```

```

List sort(Country[] items) {
List result = items.toList().sort{ p1, p2 -> p1.population <=> p2.population }
if (order == "reverse") return result.reverse() else return result
}
}
]]></lang:inline-script>
<lang:property name="order" value="forward" />
</lang:groovy>
</beans>

```

Our Java code to use this example looks like:

```

package spring;

import java.util.Arrays;
import org.springframework.context.ApplicationContext;
import org.springframework.context.support.ClassPathXmlApplicationContext;

public class SortMain {
public static void main(String[] args) {
try {
ApplicationContext ctx = new ClassPathXmlApplicationContext("beans.xml");
Country[] countries = {
(Country) ctx.getBean("country1"), (Country) ctx.getBean("country2"),
(Country) ctx.getBean("country3"), (Country) ctx.getBean("country4")
};
Sorter sorter = (Sorter) ctx.getBean("sorter");
System.out.println("Unsorted:\n" + Arrays.asList(countries));
System.out.println("Sorted:\n" + sorter.sort(countries));
} catch (Exception e) {
e.printStackTrace();
}
}
}
}

```

And the resulting output (with a little bit of hand formatting) looks like:

```

Unsorted:
[Australia[Capital=Canberra, Population=20264082],
USA[Capital=Washington, D.C., Population=298444215],
NewZealand[Capital=Wellington, Population=4076140],
JRuby object [Fiji[Capital=Suva, Population=905949]]]

Sorted:
[JRuby object [Fiji[Capital=Suva, Population=905949]],
NewZealand[Capital=Wellington, Population=4076140],
Australia[Capital=Canberra, Population=20264082],
USA[Capital=Washington, D.C., Population=298444215]]

```

What we didn't tell you yet

- Spring supports [BeanShell](#) in addition to JRuby and Groovy
- Spring supports the concept of *refreshable* beans when using the `<lang:language/>` element so that if your bean source code changes, the bean will be reloaded (see GINA or the Spring doco for more details)
- The Groovy scripting examples in the current Spring documentation are based on an old version of Groovy, ignore the `@Property` keywords and use the latest `groovy-all-xxx.jar` instead of the jars they recommend
- The `<lang:language/>` element currently only supports setter-based injection
- Spring automatically converts between the object models of the various languages but there are some limitations (particularly with JRuby - see the next section)

Current Limitations

Currently using the Groovy language through Spring is extensively supported. Using other languages like JRuby takes a little more care. Try restricting your JRuby methods to ones which take and return simple data types, e.g. long and String. You may also find that certain operations don't work as you'd expect when working between Ruby and other languages, e.g. if you defined a `compareTo` method in our `Fiji.rb` file, it would return `long` by default rather than the `int` which Java is expecting. In addition, the `compareTo` method takes an `other` object as a parameter. Currently the wrapping of this *other* object from Java or Groovy into a Ruby object hides the original Java methods.

Further Information

- Section 11.5 of [GINA](#)
- Spring [documentation](#) for [scripting](#)
- The Spring example in [Groovy and JMX](#)

Embedding Groovy

This page last changed on Oct 08, 2007 by [det](#).

Groovy is a great language just on its own in various scenarios. It is also extremely useful in mixed Groovy/Java environments. With this in mind, Groovy has been designed to be very lightweight and easy to embed into any Java application system.

There are three main approaches for natively integrating Groovy with Java. Each of these is discussed in more detail below.

Alternatively, you can use the [Bean Scripting Framework](#) to embed any scripting language into your Java code, giving you other language options if you needed them (though we can't imagine why 😊). Using BSF allows you to be more loosely coupled to your scripting language; however, native integration is more light weight and offers closer integration.

Evaluate scripts or expressions using the shell

You can evaluate any expression or script in Groovy using the

[GroovyShell](#).

The GroovyShell allows you to pass in and out variables via the

[Binding](#) object.

```
// call groovy expressions from Java code
Binding binding = new Binding();
binding.setVariable("foo", new Integer(2));
GroovyShell shell = new GroovyShell(binding);
```

```
Object value = shell.evaluate("println 'Hello World!'; x = 123; return foo * 10");
assert value.equals(new Integer(20));
assert binding.getVariable("x").equals(new Integer(123));
```

Dynamically loading and running Groovy code inside Java

You can use the

[GroovyClassLoader](#) to load classes dynamically into a Java program and execute them (or use them) directly. The following Java code shows an example:

```
ClassLoader parent = getClass().getClassLoader();
GroovyClassLoader loader = new GroovyClassLoader(parent);
Class groovyClass = loader.parseClass(new File("src/test/groovy/script/HelloWorld.groovy"));

// let's call some method on an instance
GroovyObject groovyObject = (GroovyObject) groovyClass.newInstance();
Object[] args = {};
groovyObject.invokeMethod("run", args);
```

If you have an interface you wish to use which you implement in the Groovy script you can use it as follows:

```
GroovyClassLoader gcl = new GroovyClassLoader();
Class clazz = gcl.parseClass(myStringWithGroovyClassSource, "SomeName.groovy");
Object aScript = clazz.newInstance();
MyInterface myObject = (MyInterface) aScript;
myObject.interfaceMethod();
...
```

This works fine if the Groovy class implements the interface MyInterface. myObject can from then on be used as every other Java object implementing MyInterface.

One thing to remember is that the parseClass will try to create an object from your String fileName. Another way to do the gcl.parseClass is:

```
Class clazz = gcl.parseClass(new File("SomeName.groovy"));
```

Full Example:

```
TestInterface.java
public interface TestInterface {
public void printIt();
}
```

```
Tester.groovy
public class Tester implements TestInterface {
public void printIt() {
println "this is in the test class";
}
}
```

```
TestClass.java -- inside of a method
String fileName = "Tester.groovy";
GroovyClassLoader gcl = new GroovyClassLoader();
Class clazz = gcl.parseClass(new File(fileName));
Object aScript = clazz.newInstance();
```

```
TestInterface ifc = (TestInterface) aScript;
ifc.printIt();
```

Note that all of the error handling has been removed -- you won't be able to do this in a java class. I actually use the Interface invocation for Groovy inside of a Utility Class.

The GroovyScriptEngine

The most complete solution for people who want to embed groovy scripts into their servers and have them reloaded on modification is the GroovyScriptEngine. You initialize the GroovyScriptEngine with a set of CLASSPATH like roots that can be URLs or directory names. You can then execute any Groovy script within those roots. The GSE will also track dependencies between scripts so that if any dependent script is modified the whole tree will be recompiled and reloaded.

Additionally, each time you run a script you can pass in a Binding that contains properties that the script can access. Any properties set in the script will also be available in that binding after the script has run. Here is a simple example:

/my/groovy/script/path/hello.groovy:

```
output = "Hello, ${input}!"

import groovy.lang.Binding;
import groovy.util.GroovyScriptEngine;

String[] roots = new String[] { "/my/groovy/script/path" };
GroovyScriptEngine gse = new GroovyScriptEngine(roots);
Binding binding = new Binding();
binding.setVariable("input", "world");
gse.run("hello.groovy", binding);
System.out.println(binding.getVariable("output"));
```

This will print "Hello, world!".

Embedding a Groovy Console in a Java Application

An interactive Groovy interpreter can be embedded in a running application for experimentation and testing. For a tutorial on how to do, including example code, see the cookbook example [Embedding a Groovy Console in a Java Server Application](#).

An example for the integration of Groovy as scripting language into an application can be found at [Integrating Groovy in an application - a success story](#)

Runtime dependencies

As well as Java 1.4 and the Groovy jar we also depend at runtime on the ASM library constituted of five jars (asm-2.2.jar, asm-attrs-2.2.jar, asm-analysis-2.2, asm-tree-2.2.jar, and asm-util-2.2.jar) plus the ANTLR library (antlr-2.7.5.jar). That's it. So just add these 7 jars to your classpath and away you go, you can happily embed Groovy into your application.

Alternatively, instead of several jars, you can use groovy-all-1.0-beta-x.jar included in the GROOVY_HOME/embeddable directory of your distribution: this jar contains both Groovy and ASM combined in a single and convenient archive, with the ASM classes in a different namespace, so conflicts with other libraries also using ASM will be avoided 😊

Influencing class loading at runtime

This page last changed on Feb 05, 2007 by [akaranta](#).

When writing a script, it may be unwieldy to call the script defining the whole classpath at the command line, e.g.

```
groovy -cp %JAXB_HOME%\bin\activation.jar;%JAXB_HOME%\bin\... myscript.groovy
```

You can go the other way - let the script itself find the jars it needs and add them to the classpath before using them. To do this, you need to

1. get the groovy rootloader

```
def loader = this.class.classLoader.rootLoader
```

2. introduce the necessary urls to groovy rootloader. Use whatever logic suits your situations to find the jars / class directories

```
def jardir = new File( System.getenv( 'JAXB_HOME' ), 'lib' )
def jars    = jardir.listFiles().findAll { it.name.endsWith('.jar') }
jars.each { loader.addURL(it.toURI().toURL()) }
```

3. Load the classes you need:

```
// in a script run from command line this is ok:
JAXBContext = Class.forName( 'javax.xml.bind.JAXBContext' )
Marshaller  = Class.forName( 'javax.xml.bind.Marshaller' )

// if the groovy script / class is loaded from a java app, then the above may fail as it uses the
// same classloader to load the class as the containing script / class was loaded by. In that case,
// this should work:
```

```
JAXBContext = Class.forName( 'javax.xml.bind.JAXBContext', true, loader )
Marshaller  = Class.forName( 'javax.xml.bind.Marshaller', true, loader )
```

4. To instantiate the classes, use the newInstance method:

```
def jaxbContext = JAXBContext.newInstance( MyDataClass )
```

Note that newInstance is on steroids when called from groovy. In addition to being able to call the parameterless constructor (as w/ Java's Class.newInstance()), you can give any parameters to invoke any constructor, e.g.

```
def i = MyClass.newInstance( "Foo", 12 ) // invokes the constructor w/ String and int as params
```

You can also pass a map to initialize properties, e.g.

```
def i2 = MyClass.newInstance(foo:'bar', boo:12) // creates a new instance using the parameterless
// constructor and then sets property foo to 'bar' and property boo to 12
```

The downside of using this approach is that you can't inherit from the classes you load this way - classes inherited from need to be known before the script starts to run.

Internationalization

This page last changed on Jan 05, 2008 by [paulk_asert](#).

Groovy leverages Java's I18N features. Here is a Swing example using Dates, Numbers and Locales:

```
import groovy.swing.SwingBuilder
import static javax.swing.JFrame.EXIT_ON_CLOSE as EXIT
import static java.text.NumberFormat.getNumberInstance as numberFormat
import static java.text.DateFormat.getDateInstance as dateFormat
import static java.text.DateFormat.FULL
def locales = [
new Locale("en", "US"), new Locale("ja","JP"), new Locale("iw","IL"),
new Locale("hi","IN"), new Locale("th","TH","TH"), new Locale("de", "DE"),
new Locale("es", "ES"), new Locale("zh", "CN"), new Locale("it", "IT") ]
def swing = new SwingBuilder()
int row = 0
def d = new Date()
def frame = swing.frame(title:'Frame', size:[300,300],
defaultCloseOperation:EXIT) {
tableLayout {
locales.each { loc ->
tr {
td { label(numberFormat(loc).format(++row)) }
td { label(loc.toString()) }
td { label(loc.getDisplayLanguage(loc)) }
td { label(dateFormat(FULL, loc).format(d)) }
}
}
}
}
frame.pack()
frame.show()
```

Which should look something like this:

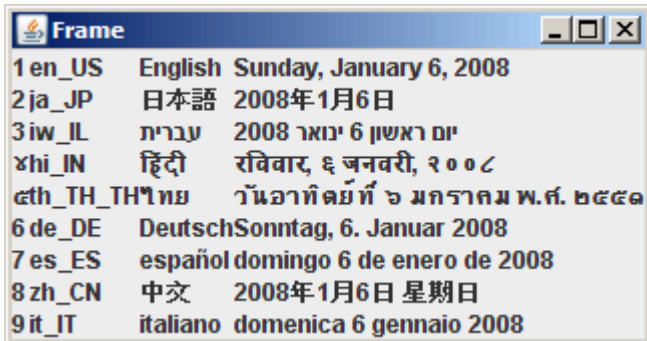

You can also use properties files to capture language strings. Using the `LablesBundle.properties`, `LablesBundle.properties_de` and `LablesBundle_fr.properties` files from [this](#) tutorial. We can then use this code:

```
def locales = [Locale.FRENCH, Locale.GERMAN, Locale.ENGLISH]
def keys = ["s1", "s2", "s3", "s4"]
[locales, keys].combinations().each{ loc, key ->
def labels = ResourceBundle.getBundle("LabelsBundle", loc)
println "Locale = ${loc.toString()}, key = $key, value = ${labels.getString(key)}"
}
```

To produce this result:

```
Locale = fr, key = s1, value = Ordinateur
Locale = de, key = s1, value = Computer
Locale = en, key = s1, value = computer
Locale = fr, key = s2, value = Disque dur
Locale = de, key = s2, value = Platte
Locale = en, key = s2, value = disk
```

Locale = fr, key = s3, value = Moniteur
Locale = de, key = s3, value = Monitor
Locale = en, key = s3, value = monitor
Locale = fr, key = s4, value = Clavier
Locale = de, key = s4, value = Tastatur
Locale = en, key = s4, value = keyboard

Make a builder

This page last changed on Mar 09, 2007 by [mktany2k](#).

To create a new builder like a the MarkupBuilder or AntBuilder, you have to implement in java (in groovy later too) a subclass of the groovy.util.BuilderSupport class.

The main methods to be implemnted are the following :

- protected abstract void setParent(Object parent, Object child);
- protected abstract Object createNode(Object name); // anode without parameter and closure
- protected abstract Object createNode(Object name, Object value); //a node without parameters, but with closure
- protected abstract Object createNode(Object name, Map attributes); // aNode without closure but with parameters
- protected abstract Object createNode(Object name, Map attributes, Object value); //a node with closure and parameters
- protected Object getName(String methodName)

The BuilderSupport.java class

```
package groovy.util;

import groovy.lang.Closure;
import groovy.lang.GroovyObjectSupport;

import java.util.List;
import java.util.Map;

import org.codehaus.groovy.runtime.InvokerHelper;

public abstract class BuilderSupport extends GroovyObjectSupport {

    private Object current;
    private Closure nameMappingClosure;
    private BuilderSupport proxyBuilder;

    public BuilderSupport() {
        this.proxyBuilder = this;
    }

    public BuilderSupport(BuilderSupport proxyBuilder) {
        this(null, proxyBuilder);
    }

    public BuilderSupport(Closure nameMappingClosure, BuilderSupport proxyBuilder) {
        this.nameMappingClosure = nameMappingClosure;
        this.proxyBuilder = proxyBuilder;
    }

    public Object invokeMethod(String methodName, Object args) {
        Object name = getName(methodName);
        return doInvokeMethod(methodName, name, args);
    }

    protected Object doInvokeMethod(String methodName, Object name, Object args) {
        Object node = null;
        Closure closure = null;
        List list = InvokerHelper.asList(args);

        //System.out.println("Called invokeMethod with name: " + name + " arguments: " + list);

        switch (list.size()) {
            case 0:
                break;
            case 1:
                {
```

```

Object object = list.get(0);
if (object instanceof Map) {
node = proxyBuilder.createNode(name, (Map) object);
} else if (object instanceof Closure) {
closure = (Closure) object;
node = proxyBuilder.createNode(name);
} else {
node = proxyBuilder.createNode(name, object);
}
}
break;
case 2:
{
Object object1 = list.get(0);
Object object2 = list.get(1);
if (object1 instanceof Map) {
if (object2 instanceof Closure) {
closure = (Closure) object2;
node = proxyBuilder.createNode(name, (Map) object1);
} else {
node = proxyBuilder.createNode(name, (Map) object1, object2);
}
} else {
if (object2 instanceof Closure) {
closure = (Closure) object2;
node = proxyBuilder.createNode(name, object1);
}
}
}
break;
case 3:
{
Object attributes = list.get(0);
Object value = list.get(1);
closure = (Closure) list.get(2);
node = proxyBuilder.createNode(name, (Map) attributes, value);
}
break;
}

if (node == null) {
node = proxyBuilder.createNode(name);
}

if (current != null) {
proxyBuilder.setParent(current, node);
}

if (closure != null) {
// push new node on stack
Object oldCurrent = current;
current = node;

// lets register the builder as the delegate
setClosureDelegate(closure, node);
closure.call();

current = oldCurrent;
}

proxyBuilder.nodeCompleted(current, node);
return node;
}

protected void setClosureDelegate(Closure closure, Object node) {

```

```

closure.setDelegate(this);
}

protected abstract void setParent(Object parent, Object child);
protected abstract Object createNode(Object name);
protected abstract Object createNode(Object name, Object value);
protected abstract Object createNode(Object name, Map attributes);
protected abstract Object createNode(Object name, Map attributes, Object value);

protected Object getName(String methodName) {
if (nameMappingClosure != null) {
return nameMappingClosure.call(methodName);
}
return methodName;
}

protected void nodeCompleted(Object parent, Object node) {
}

protected Object getCurrent() {
return current;
}

protected void setCurrent(Object current) {
this.current = current;
}
}

```

The NodeBuilder example

To be able to write such a code :

```

def someBuilder = new NodeBuilder()

someBuilder.people(kind:'folks', groovy:true) {
person(x:123, name:'James', cheese:'edam') {
project(name:'groovy')
project(name:'geronimo')
}
person(x:234, name:'bob', cheese:'cheddar') {
project(name:'groovy')
project(name:'drools')
}
}
}

```

we need :

```

package groovy.util;

import java.util.ArrayList;
import java.util.Map;

/**
 * A helper class for creating nested trees of Node objects for
 * handling arbitrary data
 *
 * @author <a href="mailto:james@coredevelopers.net">James Strachan</a>
 * @version $Revision: 1.3 $
 */
public class NodeBuilder extends BuilderSupport {

public static NodeBuilder newInstance() {
return new NodeBuilder();
}
}

```



```

protected void setParent(Object parent, Object child) {
}

protected Object createNode(Object name) {
return new Node(getCurrentNode(), name, new ArrayList());
}

protected Object createNode(Object name, Object value) {
return new Node(getCurrentNode(), name, value);
}

protected Object createNode(Object name, Map attributes) {
return new Node(getCurrentNode(), name, attributes, new ArrayList());
}

protected Object createNode(Object name, Map attributes, Object value) {
return new Node(getCurrentNode(), name, attributes, value);
}

protected Node getCurrentNode() {
return (Node) getCurrent();
}
}

```

The MarkupBuilder.java class as second example

```

package groovy.xml;

import groovy.util.BuilderSupport;
import groovy.util.IndentPrinter;

import java.io.PrintWriter;
import java.io.Writer;
import java.util.Iterator;
import java.util.Map;

/**
 * A helper class for creating XML or HTML markup
 *
 * @author <a href="mailto:james@coredevelopers.net">James Strachan</a>
 * @author Stefan Matthias Aust
 * @version $Revision: 1.8 $
 */
public class MarkupBuilder extends BuilderSupport {

private IndentPrinter out;
private boolean nospace;
private int state;
private boolean nodeIsEmpty = true;

public MarkupBuilder() {
this(new IndentPrinter());
}

public MarkupBuilder(PrintWriter writer) {
this(new IndentPrinter(writer));
}

public MarkupBuilder(Writer writer) {
this(new IndentPrinter(new PrintWriter(writer)));
}

public MarkupBuilder(IndentPrinter out) {
this.out = out;
}

```

```

}

protected void setParent(Object parent, Object child) {
}

/*
public Object getProperty(String property) {
if (property.equals("_")) {
nospace = true;
return null;
} else {
Object node = createNode(property);
nodeCompleted(getCurrent(), node);
return node;
}
}
*/

protected Object createNode(Object name) {
toState(1, name);
return name;
}

protected Object createNode(Object name, Object value) {
toState(2, name);
out.print(">");
out.print(value.toString());
return name;
}

protected Object createNode(Object name, Map attributes, Object value) {
toState(1, name);
for (Iterator iter = attributes.entrySet().iterator(); iter.hasNext();) {
Map.Entry entry = (Map.Entry) iter.next();
out.print(" ");
print(transformName(entry.getKey().toString()));
out.print("=");
print(transformValue(entry.getValue().toString()));
out.print("");
}
if (value != null)
{
nodeIsEmpty = false;
out.print(">" + value + "</" + name + ">");
}
return name;
}

protected Object createNode(Object name, Map attributes) {
return createNode(name, attributes, null);
}

protected void nodeCompleted(Object parent, Object node) {
toState(3, node);
out.flush();
}

protected void print(Object node) {
out.print(node == null ? "null" : node.toString());
}

protected Object getName(String methodName) {
return super.getName(transformName(methodName));
}

protected String transformName(String name) {

```

```

if (name.startsWith("_")) name = name.substring(1);
return name.replace('_', '-');
}

protected String transformValue(String value) {
return value.replaceAll("\\'", "&quot;");
}

private void toState(int next, Object name) {
switch (state) {
case 0:
switch (next) {
case 1:
case 2:
out.print("<");
print(name);
break;
case 3:
throw new Error();
}
break;
case 1:
switch (next) {
case 1:
case 2:
out.print(">");
if (nospace) {
nospace = false;
} else {
out.println();
out.incrementIndent();
out.printIndent();
}
out.print("<");
print(name);
break;
case 3:
if (nodeIsEmpty) {
out.print(" />");
}
break;
}
break;
case 2:
switch (next) {
case 1:
case 2:
throw new Error();
case 3:
out.print("</");
print(name);
out.print(">");
break;
}
break;
case 3:
switch (next) {
case 1:
case 2:
if (nospace) {
nospace = false;
} else {
out.println();
out.printIndent();
}
out.print("<");

```

```
print(name);
break;
case 3:
if (nospace) {
nospace = false;
} else {
out.println();
out.decrementIndent();
out.printIndent();
}
out.print("</");
print(name);
out.print(">");
break;
}
break;
}
state = next;
}

}
```

Mixed Java and Groovy Applications

This page last changed on Nov 19, 2006 by [paulk_asert](#).

This example looks at the issues surrounding a mixed Java/Groovy application. This issue only arises when there is mutual dependencies between your mixed language source files. So, if part of your system is pure Java for instance, you won't have this problem. You would just compile that part of your system first and reference the resulting class/jar file(s) from the part of your system that was written in Groovy.

The legacy version of our application

Suppose you have an initial application written in Java. It deals with packages sent through the post. It has the following `Postpack` class (you would typically need some additional fields but we have simplified our domain to keep the example simple):

```
package v1;

public class Postpack implements Comparable {
    private final int weight;
    private final int zip;

    public int getWeight() {
        return weight;
    }

    public int getZip() {
        return zip;
    }

    public String toString() {
        return "Postpack[Weight=" + weight + ", Zip=" + zip + "];"
    }

    public int compareTo(Object o) {
        Postpack other = (Postpack) o;
        return zip - other.getZip();
    }

    public Postpack(int weight, int zip) {
        this.weight = weight;
        this.zip = zip;
    }
}
```

Now suppose you also have a sort helper class `ZipSorter` as follows:

```
package v1;

import java.util.List;
import java.util.Collections;

public class ZipSorter {
    public List sort(List items) {
        Collections.sort(items);
        return items;
    }
}
```

Finally, you have a main application as follows:

```
package v1;

import java.util.Arrays;

public class SortMain {
    private static Postpack[] packs = { new Postpack(60, 12345),
```

```

new Postpack(55, 98765),
new Postpack(50, 54321) };
private static ZipSorter sorter = new ZipSorter();
public static void main(String[] args) {
System.out.println("Sorted=" + sorter.sort(Arrays.asList(packs)));
}
}

```

A futile attempt at a quick hack

We have been asked to make a version 2 of our application which supports not only `Postpack` objects but also `Box` objects. We must also support the ability to sort by weight as well as Zip. We have been given incredibly short time scales to develop the application, so we decide to write all of the new functionality using Groovy.

We start by creating a Groovy `Box` class and make it behave in the way `ZipSorter` is expecting, e.g. we make it implement `Comparable` even though this wouldn't be needed if everything was going to be in Groovy. We then modify `ZipSorter` to know about `Box`. We then create `WeightSorter` and write it to know about both `Postpack` and `Box`.

To simplify development (we think) we create separate `groovy` and `java` source directories. We develop our files incrementally in our IDE and everything works fine. We think we are finished, so we do a rebuild all for our project. All of a sudden the project won't compile. We dive out to `ant` and use the `javac` and `groovyc` tasks to put compile our separated source directories. Still no luck. What happened?

We inadvertently introduced a cyclic dependency into our codebase and we only got away with it originally because the incremental development style we were using hid away the problem. The issue is that IDEs and current build systems like `Ant` use different compilers for Java and Groovy. So while Java and Groovy are the same at the bytecode level, their respective compilers know nothing about the source code of the other language. (Recent discussions have begun about how to eventually remove this separation).

Our hack failed because if we run `javac` first, `ZipSorter` won't have the `Box` class available because it is written in Groovy. If we run `groovyc` first, `WeightSorter` doesn't have the `Postpack` class because it is written in Java. Similarly, if using our IDE, we will face the same deadly embrace problem.

A proper version 2 of our application

The way we get around this problem is to define some common interfaces as follows:

```

package v2;

public interface Parcel {
int getWeight();
int getZip();
}

package v2;

import java.util.List;

public interface Sorter {
List sort(Parcel[] unsorted);
}

```

Now we write our Java and Groovy parts of the system being careful to refer only to the interfaces, e.g. the Java files would become:

```

package v2;

public class Postpack implements Parcel, Comparable {
private final int weight;
private final int zip;

public int getWeight() {

```

```

return weight;
}

public int getZip() {
return zip;
}

public String toString() {
return "Postpack[Weight=" + weight + ", Zip=" + zip + "];"
}

public Postpack(int weight, int zip) {
this.weight = weight;
this.zip = zip;
}

public int compareTo(Object o) {
Parcel other = (Parcel) o;
return zip - other.getZip();
}
}

package v2;

import java.util.List;
import java.util.Arrays;

public class ZipSorter implements Sorter {
public List sort(Parcel[] items) {
Arrays.sort(items);
return Arrays.asList(items);
}
}

```

And the Groovy ones look like:

```

package v2
public class Box implements Parcel, Comparable {
int weight
int zip
String toString() {
return "Box[Weight=" + weight + ", Zip=" + zip + "]"
}
int compareTo(other) { return zip - other.zip }
}

package v2
public class WeightSorter implements Sorter {
List sort(Parcel[] items) {
items.toList().sort{ p1, p2 -> p1.weight <=> p2.weight }
}
}

```

Finally, our main method looks like:

```

package v2;

import java.util.Arrays;

public class SortMain {
private static Box box1 = new Box();
private static Parcel[] packs = { new Postpack(60, 12345), box1,
new Postpack(50, 54321) };
private static Sorter zipSorter = new ZipSorter();
private static Sorter weightSorter = new WeightSorter();
public static void main(String[] args) {
box1.setWeight(55);
}
}

```

```
box1.setZip(99999);
System.out.println("Unsorted:          " + Arrays.asList(packs));
System.out.println("Sorted by weight: " + weightSorter.sort(packs));
System.out.println("Sorted by zip:    " + zipSorter.sort(packs));
}
}
```

We need to compile the interfaces first, then we can compile the Groovy or Java files (excluding `SortMain`) in either order. Finally we compile `SortMain` as it is the class that knows about the concrete implementations. If we were using dependency injection or our own factory methods we could have reduced or eliminated the need to treat `SortMain` as a special case, e.g. using Spring we could have the concrete classes listed in an external `beans.xml` file and `SortMain` whether it was written in Java or Groovy could have been compiled along with all the other files written in its language.

Now when we run the program we get the following output:

```
Unsorted:          [Postpack[Weight=60, Zip=12345], Box[Weight=55, Zip=99999], Postpack[Weight=50,
Zip=54321]]
Sorted by weight: [Postpack[Weight=50, Zip=54321], Box[Weight=55, Zip=99999], Postpack[Weight=60,
Zip=12345]]
Sorted by zip:    [Postpack[Weight=60, Zip=12345], Postpack[Weight=50, Zip=54321], Box[Weight=55,
Zip=99999]]
```

For more details, see chapter 11 of [GINA](#).

Optimising Groovy bytecodes with Soot

This page last changed on Aug 21, 2007 by chanwit@gmail.com.

Here's a quick steps to get your Groovy classes optimised using Soot framework.

Problems

When using Groovy, sometime we encounter the `OutOfMemoryException` because PermGen space ran out. Optimisation of class files could help saving memory usage of JVM.

Soot Framework

Soot Framework is a bytecode optimisation, and manipulation framework, developed at McGill University, for Java. It comes with a vast set of optimisation techniques. We can also develop our own optimisation using the framework provided.

Quick Optimisation

With Soot, you can just run

```
> soot.Main -O my.package.MyGroovyClass
```

to obtain a optimised class.

Analysis

A trivial class is used in this analysis. The class is illustrated in Jimple format, an intermediate representation supported by Soot to see what's done with Soot optimisation.

Here's a command to get a Jimple file:

```
> soot.Main -f jimple org.codehaus.groovy.aop.tests.Target
```

and the following is a command for applying optimisation:

```
> soot.Main -O -f jimple org.codehaus.groovy.aop.tests.Target
```

We've now got two Jimple files, and can use a text editor to compare them. You can get this two files from the attachment below to see their differences.

The result from the optimisation shows that Soot can reduce the file size by 8.5%. This number is expected to be large when we apply the optimisation to the whole program.

Second Experiment

This is an updated result when applying the more complex optimisation to two of Groovy packages, `groovy.lang` and `groovy.xml`.

```
> soot.Main -O -via-shimple -process-dir groovy-1.1
```

Please note that not all Groovy classes were used in this experiment. Just two mentioned packages resides in the "groovy-1.1" folder. This experiment has done by performing optimisation package that requires Static Single Assignment (SSA) representation of Java classes. Soot supports this through Shimple format. The "-via-shimple" option shown in the command line is to enable this kind of optimisation. The result is better than using only Jimple optimisation. Size of Groovy classes in the two packages is reduced by **16.34%**.

Polyglot Programming with Groovy

This page last changed on Apr 22, 2008 by [paulk_asert](#).

A fun activity in the late 1980's and early 1990's was to write [polyglot](#) programs that ran in multiple languages, e.g. check out [this one](#) which runs in COBOL, Pascal, Fortran, C, PostScript, Linux/Unix shell script (bash, sh, csh), x86 machine language and Perl! More recently the term has resurfaced (e.g. [Neal](#), [Martin](#) and others) in recognition of the fact that a developer no longer lives in a world dominated just by one language, e.g. COBOL, Java, C#. As a minimum, a developer must know JavaScript for AJAX sights, SQL for databases, XML, various build file dialects, various scripting languages etc., in addition to one or more mainstream languages.

This interest has been increasing lately with multiple languages being [emphasised](#) on both the [JVM](#) and the [CLR](#). Groovy obviously supports a polyglot relationship with Java (e.g. A Groovy class can inherit from a Java class which can inherit from a Groovy class). In other cases Groovy reduces the need to introduce multiple languages because it gives you a Groovy syntax where you might otherwise have to introduce a new language, e.g. using GPath instead of introducing XPath, using datasets instead of SQL, AntBuilder instead of Ant XML files and so on. Other features just make integration with other languages a little easier, e.g. Groovy's regex, multi-line string, GString and template support.

Groovy also has other Polyglot friendly features or integration possibilities:

- Consider combining [Functional Programming](#) with Groovy
- Considering using some [Constraint or logic programming](#) with your Groovy
- Consider accessing other [languages via JSR-223](#)

Constraint Programming

This page last changed on Apr 21, 2008 by [paulk_asert](#).

[Constraint programming](#) is a style of programming where relations between variables are stated in the form of constraints. This form of programming was first made popular by logic programming languages such as [Prolog](#) but the style is now also used outside logic programming specific languages. Constraints differ from the common primitives of other programming languages in that they do not specify one or more steps to execute but rather the properties of a solution to be found. If you want use a constraint-specific programming language, maybe Prolog is for you. If however you like Groovy, but want to apply a touch of constraint style flavor to your code, read on to learn about Gecode/J, Choco and tuProlog integration possibilities.

Gecode/J

Gecode/J is a Java interface for the Gecode C++ constraint programming library. Let's have a look at making the [Money example](#) from the Gecode/J library a bit Groovier. If you haven't seen the example before, it involves solving the following puzzle:

```
S E N D
+  M O R E
= M O N E Y
```

How can I replace the letters in the puzzle with numbers so that the numbers add up in the expected way? See [here](#) for further details.

A little helper library

First we can create a little helper library to make our subsequent code a little Groovier:

```
import static org.gecode.Gecode.*
import static org.gecode.GecodeEnumConstants.*
import org.gecode.*

class GroovySpace extends Space {
public GroovySpace() {
super()
}
public GroovySpace(Boolean share, GroovySpace space) {
super(share, space)
}
def notEqual(IntVar v, val) {
rel(this, v, IRT_NQ, val, ICL_BND)
}
def distinct(VarArray<IntVar> v) {
distinct(this, v, ICL_BND)
}
def expressionsEqual(Expr e1, Expr e2) {
post(this, e1, IRT_EQ, e2)
}
def branchOverVariables(VarArray<IntVar> v) {
branch(this, v, BVAR_SIZE_MIN, BVAL_MIN)
}
def variableOverRange(v, r) {
new IntVar(this, v, r.from, r.to)
}
}
```

A Groovy Solution

Here is how we could now code the solution.

```
import org.gecode.*

class Money extends GroovySpace {
```

```

public VarArray<IntVar> letters

public Money() {
    super()

    // We need 8 variables. Each one gets the name of it's
    // corresponding letter, and an initial domain of [0..9]
    letters = new VarArray<IntVar>(8)
    "SENDMORY".each{ letters.add(variableOverRange(it, 0..9)) }
    def s = letters[0]
    def e = letters[1]
    def n = letters[2]
    def d = letters[3]
    def m = letters[4]
    def o = letters[5]
    def r = letters[6]
    def y = letters[7]

    // set up constraints
    notEqual(s, 0)
    notEqual(m, 0)
    expressionsEqual(
        new Expr()
        .p(1000, s).p(100, e).p(10, n).p(d)
        .p(1000, m).p(100, o).p(10, r).p(e),
        new Expr()
        .p(10000, m).p(1000, o).p(100, n).p(10, e).p(y))
    distinct(letters)

    // start looking for solutions
    branchOverVariables(letters)
}

public Money(Boolean share, Money money) {
    super(share, money)
    letters = new VarArray<IntVar>(this, share, money.letters)
}

def opt = new Options("SEND+MORE=MONEY")
opt.gui = true
opt.parse(args)
opt.doSearch(new Money())

```

It relies on the same `Options` class used in the original Java example.

Running this code (we used a Java 6 JVM with the following JVM argument, `-Djava.library.path=C:\Geocode\bin`) yields:

```

SEND+MORE=MONEY:
letters=[S=9,E=5,N=6,D=7,M=1,O=0,R=8,Y=2]

```

```

Summary:
runtime:      3
solutions:    1
propagations: 11
failures:     1
clones:       2
commits:      3
peak memory:  6KB

```

Running the program with the `-gui` command line argument yields the following GUI display:

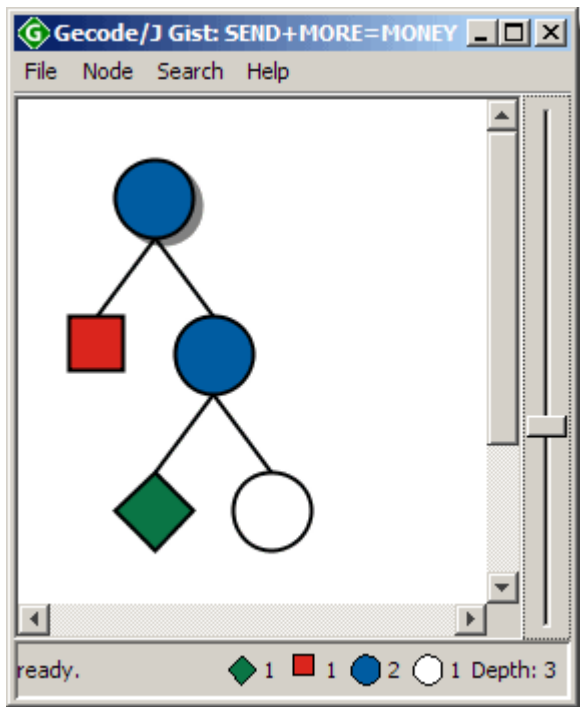

It would be fun to take this example a little further with a proper DSL to define the constraints.

Choco

[Choco](#) is a java library for constraint satisfaction problems (CSP), constraint programming (CP) and explanation-based constraint solving (e-CP). It is built on an event-based propagation mechanism with backtrackable structures. It's a great alternative to Gecode/J especially if you want a Java only solution.

Choco Magic Squares

We'll look at solving the [Magic Square](#) problem (though we haven't coded up making the diagonals add up too, just the rows and columns). Converting [this example](#) to Groovy yields:

```
import choco.integer.IntVar
import choco.integer.IntDomainVar
import choco.Problem

int n = 4
int nsq = n * n
println "Magic Square Problem with n = " + n

def p = new Problem()
// create variables
def vars = new IntDomainVar[nsq]
for (i in 0..<n)
for (j in 0..<n)
vars[i * n + j] = p.makeEnumIntVar("C${i}_${j}", 1, nsq)
int sumAllSquares = nsq * (nsq + 1) / 2
def sum = p.makeEnumIntVar("S", 1, sumAllSquares)

// vars should be pairwise distinct
for (i in 0..<nsq)
for (j in 0..<i)
p.post(p.neq(vars[i], vars[j]))

int[] coeffs = [1] * n

for (i in 0..<n) {
```

```

// all cols should add to sum
IntVar[] col = (0..<n).collect{ j -> vars[i * n + j] }
p.post(p.eq(p.scalar(coeffs, col), sum))
// all rows should add to sum
IntVar[] row = (0..<n).collect{ j -> vars[j * n + i] }
p.post(p.eq(p.scalar(coeffs, row), sum))
}

p.solve() // find first solution
for (i in 0..<n) {
for (j in 0..<n)
print vars[i * n + j].val.toString().padLeft(3)
println()
}

```

And has this output when run:

```

Magic Square Problem with n = 4
1  2 15 16
6 11 10  7
13  9  4  8
14 12  5  3

```

Going Further

We can have a little more fun with this example. First, let's make the diagonals also add up:

```

IntVar[] downdiag = (0..<n).collect{ i -> vars[i * n + i] }
IntVar[] updiag = (0..<n).collect{ i -> vars[i * n + n - i - 1] }
p.post(p.eq(p.scalar(coeffs, downdiag), sum))
p.post(p.eq(p.scalar(coeffs, updiag), sum))

```

Now, let's also make the left kite (defined as below):

```

-- xx -- --
xx -- xx --
-- -- -- --
-- xx -- --

```

Also add up to the magic square value:

```

IntVar[] leftkite = [vars[1], vars[4], vars[6], vars[13]]
p.post(p.eq(p.scalar(coeffs, leftkite), sum))

```

Finally, let's make the middle columns in the bottom row equal to '1514':

```

IntVar[] date = [vars[13], vars[14]]
int[] datecoeffs = [100, 1]
p.post(p.eq(p.scalar(datecoeffs, date), 1514))

```

Let's see what solutions we now have:

```

def more = p.solve()
while (more) {
println "Success at move: $p.solver.searchSolver.nodeCount"
for (i in 0..<n) {
for (j in 0..<n)
print vars[i * n + j].val.toString().padLeft(3)
println()
}
more = p.nextSolution()
}

```

Which yields the following results:

```

Dürer Magic Square Problem
Success at move: 1231

```

```

16 1 4 13
7 10 11 6
9 8 5 12
2 15 14 3
Success at move: 1236
16 1 4 13
11 6 7 10
5 12 9 8
2 15 14 3
Success at move: 1299
16 3 2 13
5 10 11 8
9 6 7 12
4 15 14 1
Success at move: 1300
16 3 2 13
9 6 7 12
5 10 11 8
4 15 14 1

```



The third solution in this list matches the famous Albrecht Dürer engraving.

This engraving has the following properties (from wikipedia):

"The order-4 magic square in Albrecht Dürer's engraving Melancholia I is believed to be the first seen in European art. The sum 34 can be found in the rows, columns, diagonals, each of the quadrants, the center four squares, the corner squares, the four outer numbers clockwise from the corners (3+8+14+9) and likewise the four counter-clockwise (the locations of four queens in the two solutions of the 8 queens puzzle), the two sets of four symmetrical numbers (2+8+9+15 and 3+5+12+14) and the sum of the middle two entries of the two outer columns and rows (e.g. 5+9+8+12), as well as several kite-shaped quartets, e.g. 3+5+11+15; the two numbers in the middle of the bottom row give the date of the engraving: 1514."

tuProlog

[tuProlog](#) is a Java-based light-weight Prolog for Internet applications and infrastructures. It offers numerous integration options: allowing Prolog syntax to be used in the form of *theories*; programatic theory construction using a Java-based API; and mechanisms to call back into Groovy and Java from Prolog.

Magic Squares

We can code up an order 3 Magic square problem as follows:

```

// require(url:'http://www.alice.unibo.it/tuProlog/', jar:'tuprolog.jar', version:'2.1')
import alice.tuprolog.*

def engine = new Prolog()
def digits = (1..9).collect{ "d($it)." }.join('\n')
def vars = ('A'..'I')
def combos = []
('A'..'H').each { outer ->
(outer.next()..'I').each{ inner ->
combos << /$outer=\=$inner/
}
}
def all = vars.join(',')
engine.theory = new Theory("""
$digits

```

```

sum(X,Y,Z):-d(X),d(Y),d(Z),(X+Y+Z)=:=15.
rows($all):-sum(A,B,C),sum(D,E,F),sum(G,H,I).
cols($all):-sum(A,D,G),sum(B,E,H),sum(C,F,I).
diags($all):-sum(A,E,I),sum(G,E,C).
distinct($all):-${combos.join(',')}.
"""
def answer = engine.solve("rows($all),cols($all),diags($all),distinct($all).")
def squares = ('A'..'I').collect{ answer.getTerm(it).toString().padLeft(3) }
for (row in 0..2) {
for (col in 0..2)
print squares[row * 3 + col]
println()
}

```

The result is:

```

2 7 6
9 5 1
4 3 8

```

Family Trees

Finally, here is a Groovy version of the typical first Prolog program, which demonstrates the simplest of *relational reasoning*:

```

// require(url:'http://www.alice.unibo.it/tuProlog/', jar:'tuprolog.jar', version:'2.1')
import alice.tuprolog.*

/** Pretty Printing */
def pprint(soln) {
println soln.isSuccess() ? "$soln.query = $soln.solution" : 'no solution found'
}

/** Prolog clauses */
def getTheory() {
new Theory("""

parent(pam, bob).
parent(tom, bob).
parent(tom, liz).
parent(bob, ann).
parent(bob, pat).
parent(pat, jim).

female(pam).
male(tom).
male(bob).
female(liz).
female(pat).
female(ann).
male(jim).

offspring(X,Y) :- parent(Y,X).

mother(X,Y) :-
parent(X,Y),
female(X).
father(X,Y) :-
parent(X,Y),
male(X).

grandparent(X,Z) :-
parent(X,Y),
parent(Y,Z).
grandmother(X,Y) :-
grandparent(X,Y),

```



```

female(X).
grandfather(X,Y) :-
grandparent(X,Y),
male(X).

sister(X,Y) :-
/* different(X,Y), */
parent(Z,X),
parent(Z,Y),
female(X).
brother(X,Y) :-
/* different(X,Y), */
parent(Z,X),
parent(Z,Y),
male(X).

ancestor(X,Y) :- parent(X,Y).
ancestor(X,Z) :-
parent(X,Y),
ancestor(Y,Z).

"""
}

def engine = new Prolog()
engine.theory = theory
pprint engine.solve('ancestor(tom,X).')
while(engine.hasOpenAlternatives()) {
pprint engine.solveNext()
}

```

The Prolog engine will determine that Tom's ancestors are: bob, liz, ann, pat & jim.

```

ancestor(tom,X) = ancestor(tom,bob)
ancestor(tom,X) = ancestor(tom,liz)
ancestor(tom,X) = ancestor(tom,ann)
ancestor(tom,X) = ancestor(tom,pat)
ancestor(tom,X) = ancestor(tom,jim)
no solution found

```

Functional Programming

This page last changed on Apr 21, 2008 by [paulk_asert](#).

[Functional programming](#) is a style of programming that emphasizes the application of functions to solve computing problems. This is in contrast with imperative programming, which emphasizes changes in state and the execution of sequential commands. If you want use a functional-only programming language, you should consider something like [Haskell](#). If however you like Groovy but want to apply some functional style magic, read on.

Functional Basics

Groovy's functions (like Java's) can be used to define functions which contain no imperative steps, e.g. a factorial function may look like:

```
def fac(n) { n == 0 ? 1 : n * fac(n - 1) }
assert 24 == fac(4)
```

In Groovy, we gain some slight syntactic sugar over Java in that we can leave out the *return* statements (the last evaluated expression is the default return value).

We can of course start to mix and match functional and imperative coding styles as in this quicksort example:

```
def sort(list) {
  if (list.isEmpty()) return list
  anItem = list[0]
  def smallerItems = list.findAll{it < anItem}
  def equalItems = list.findAll{it == anItem}
  def largerItems = list.findAll{it > anItem}
  sort(smallerItems) + equalItems + sort(largerItems)
}

assert [1, 3, 4, 5] == sort([1, 4, 5, 3])
assert [1, 1, 3, 4, 4, 5, 8] == sort([4, 1, 4, 1, 8, 5, 3])
assert ['a', 'b', 'c'] == sort(['c', 'b', 'a'])
```

Curry functions

You can fix the values for one or more arguments to a closure instance using the `curry()` method as follows:

```
def joinTwoWordsWithSymbol = { symbol, first, second -> first + symbol + second }
assert joinTwoWordsWithSymbol('#', 'Hello', 'World') == 'Hello#World'

def concatWords = joinTwoWordsWithSymbol.curry(' ')
assert concatWords('Hello', 'World') == 'Hello World'

def prependHello = concatWords.curry('Hello')
// def prependHello = joinTwoWordsWithSymbol.curry(' ', 'Hello')
assert prependHello('World') == 'Hello World'
```

If you supply one argument to the `curry()` method you will fix the first argument. If you supply *N* arguments you will fix arguments *1..N*. See reference 1 or Chapter 5 of [GINA](#) for further details.

Lazy evaluation

One particular style of functional programming of particular merit is to make use of lazy evaluation. This allows you to define infinite structures (see the next section), devise particularly efficient solutions to certain kinds of problems, and come up with very elegant solutions to otherwise hard problems. The good news is that several parts of Groovy already make use of this style and they typically hide away the hard bits so you don't need to know what magic is happening on your behalf. Here's some examples:

- `XmlSlurper` allows arbitrary GPath expressions to be crafted. As you create the expressions, you might think that XML parsing is going on behind the covers pulling XML nodes into and out of lists to match what your expressions are asking for. This is not the case. Instead a lazy representation of your GPath is stored away. When you need to evaluate the final result of a GPath expression, it calculates just what it needs to determine the expressions resulting value. [See chapter 12 of [GINA](#) for more information about `XmlSlurper`.]
- Groovy's `DataSet` feature does the same thing for data stored in relational databases. As you build up your dataset queries, no connections or operations to the database are happening under the covers. At the time when you need the result, an optimised query minimising SQL traffic is invoked to return the required result. [See section 10.2 of [GINA](#) for more information about `DataSets`.]

Infinite structures

See reference 2 below for all the details, but to give you a flavour, first you must define some lazy list handling functions, then you can define and use infinite streams. Here is an example:

```
// general purpose lazy list class
class LazyList {
  def car
  private Closure cdr
  LazyList(def car, Closure cdr) { this.car=car; this.cdr=cdr }
  def LazyList getCdr() { cdr ? cdr.call() : null }
  def List take(n) {
    def r = []; def l = this
    n.times { r.add(l.car); l = l.cdr }
    r
  }
  def LazyList filter(Closure pred) {
    if (pred(car)) return pred.owner.cons(car, { getCdr().filter(pred) })
    else return getCdr().filter(pred)
  }
}

// general purpose lazy list function
def cons(val, Closure c) { new LazyList(val, c) }

// now define and use infinite streams
def integers(n) { cons(n, { integers(n+1) }) }
def naturalnumbers = integers(1)
assert '1 2 3 4 5 6 7 8 9 10' == naturalnumbers.take(10).join(' ')
def evennumbers = naturalnumbers.filter{ it % 2 == 0 }
assert '2 4 6 8 10 12 14 16 18 20' == evennumbers.take(10).join(' ')
```

If you are not familiar with traditional functional programming terms like `cons`, `car` and `cdr`, you may find the refactored version below (creds to Alexander Kriegisch) somewhat more readable:

```
class LazyList {
  def head
  private Closure tail
  LazyList(def head, Closure tail) { this.head=head; this.tail=tail }
  def LazyList getTail() { tail ? tail.call() : null }
  def List getFirst(n) {
    def result = []; def current = this
    n.times { result.add(current.head); current = current.tail }
    result
  }
  def LazyList filter(Closure matchExpr) {
    if (matchExpr(head))
      return matchExpr.owner.prepend(head, { getTail().filter(matchExpr) })
    else
      return getTail().filter(matchExpr)
  }
}

// general purpose lazy list function
```

```
def prepend(val, Closure c) { new LazyList(val, c) }

// now define and use infinite streams
def integers(n) { prepend(n, { integers(n+1) }) }
def naturalnumbers = integers(1)
assert '1 2 3 4 5 6 7 8 9 10' == naturalnumbers.getFirst(10).join(' ')
def evennumbers = naturalnumbers.filter{ it % 2 == 0 }
assert '2 4 6 8 10 12 14 16 18 20' == evennumbers.getFirst(10).join(' ')
```

More Information

See also:

1. [Practically Groovy: Functional programming with curried closures](#)
2. [Infinite Streams in Groovy](#)
3. [Functional Programming Languages](#)
4. [Why Functional Programming Matters](#)
5. [Functional programming in the Java language](#)
6. [Post on functional programming in Java - maybe a tad verbose](#)
7. [FunctionalJ - A library for Functional Programming in Java](#)
8. [Weak versus strong languages, who wins the fight?](#)
9. [Programming Languages: Application and Interpretation](#)
10. [Beyond Groovy 1.0: Groovy goes Lisp](#)

JSR-223 access to other JVM languages

This page last changed on Apr 22, 2008 by [paulk_asert](#).

[JSR-223](#) is designed to allow Java access to many scripting languages. This means that it also provides hooks for Groovy to those other languages.

JSR-223 comes with Java 6. Here is how you can use it. First we define a script manager:

```
mgr = new javax.script.ScriptEngineManager()
```

Now, we can call out to JavaScript:

```
// included in Java 6
println 'javascript: ' + mgr.getEngineByName("javascript").eval('''
function factorial(n) {
if (n == 0) {
return 1;
}
return n * factorial(n - 1);
}
factorial(4)
''')
```

Or JRuby:

```
// requires jruby and jruby-engine jars
println 'jruby: ' + mgr.getEngineByName("jruby").eval('''
def factorial(n)
if n == 0
1
else
n * factorial(n - 1)
end
end
factorial(4)
''')
```

Or Jython:

```
// requires jython and jython-engine jars
engine = mgr.getEngineByName("jython")
engine.eval('''
def factorial(n):
i=fact=1
while i <= n:
fact=fact*i
i=i+1
return fact

result = factorial(4)
''')
println 'jython: ' + engine.result
```

Or Jaskell:

```
// requires jaskell and jaskell engine and jparsec and jfunutil jars
engine = mgr.getEngineByName("jaskell")
engine.eval('factorial n = if n > 0 then n * factorial (n-1) else 1')
println 'jaskell: ' + engine.eval('factorial 4')
```

The output from running these scripts is:

```
javascript: 24.0
jruby: 24
jython: 24
jaskell: 24
```

See also: [Accessing Groovy from Java via JSR-223](#)

Refactoring with Groovy

This page last changed on Aug 07, 2007 by [paulk_asert](#).

Code and Design [Refactoring](#) is any change to a computer systems' code or design which improves its readability or simplifies its structure without changing its results.

Here we illustrate refactoring techniques which are applicable to Groovy. In general, most Java refactoring techniques apply equally well to Groovy. Sometimes Groovy adds a new twist as well.

We don't discuss tool support to auto implement some of these refactoring techniques. Consult your IDE plugin documentation to see if it has any specific support that you can use.

Refactoring Techniques

- [Introduce Assertion](#)
- [Replace Inheritance with Delegation](#)

References

1. Martin Fowler (1999). *Refactoring: Improving the Design of Existing Code*. Addison-Wesley. ISBN 0-201-48567-2.
2. Joshua Kerievsky (2004). *Refactoring To Patterns*. Addison-Wesley. ISBN 0-321-21335-1.
3. Michael Feathers (2005). *Working Effectively with Legacy Code*. Prentice Hall. ISBN 0-13-117705-2.
4. Dierk Koenig with Andrew Glover, Paul King, Guillaume Laforge and Jon Skeet (2007). *Groovy in Action*. Manning. ISBN 1-932394-84-2. Discusses the importance of having tests in place before refactoring.

See also: [Design Patterns with Groovy](#)

Introduce Assertion

This page last changed on May 20, 2007 by [paulk_asert](#).

The [Introduce Assertion](#) refactoring recommends that if a section of code is going to make an assumption about the current state of the program, that an explicit assertion should check those assumptions first.

A common usage of this refactoring is to check that each method (and potentially each constructor) checks its preconditions using assertions. This is a particular form of defensive programming. Some argue that if you have sufficient tests in place, you don't need to apply defensive programming. For the small extra performance penalty, it seems like a small price to pay for extra resilience in our system.

Example

Suppose we have the following method:

```
/**
 * Interleave two strings.
 * Assumes input parameters aren't null.
 */
def interleave(String a, String b) {
  int maxlength = [a.size(), b.size()].max()
  def sb = new StringBuffer()
  (0..<maxlength).each{
    if (it < a.size()) sb << a[it]
    if (it < b.size()) sb << b[it]
  }
  sb
}

println interleave('Hello', 'World!')
// => HWeolrllod!
//println interleave(null, 'World!')
// => NullPointerException (somewhere within the method call)
```

If we call it with valid parameters, everything is fine. If we call it with null we will receive a `NullPointerException` during the method's execution. This can sometimes be difficult to track down.

Applying this refactoring gives us the following code:

```
package introduceAssertion

def interleave(String a, String b) {
  assert a != null, 'First parameter must not be null'
  assert b != null, 'Second parameter must not be null'
  int maxlength = [a.size(), b.size()].max()
  def sb = new StringBuffer()
  (0..<maxlength).each{
    if (it < a.size()) sb << a[it]
    if (it < b.size()) sb << b[it]
  }
  sb
}

println interleave('Hello', 'World!')
// => HWeolrllod!
//println interleave(null, 'World!')
// => AssertionError: First parameter must not be null.
```

This is better because we become aware of any problems straight away.

Replace Inheritance with Delegation

This page last changed on Jul 19, 2007 by [paulk_asert](#).

The [Replace Inheritance with Delegation](#) refactoring (sometimes known as *Replace Implementation Inheritance With Composition*) provides a systematic way to replace inheritance hierarchies.

Inheritance hierarchies allow system designers to elegantly express relationships between different types of objects in a system. However, such hierarchies can be difficult to implement and refactor. Many developers favour restricting the use of inheritance hierarchies to very simple scenarios. If you started out using inheritance hierarchies (perhaps you had a simple scenario to start with) but are now finding the inheritance hierarchy is now getting in the way, apply this pattern.

Property Example

Suppose we have the following property-centric class:

```
class Person {
  def name
  def age
  def nationality
}
```

We might have a related class such as this:

```
class StaffMemberUsingInheritance extends Person {
  def salary
}
```

For this simple case, we can stop here. For more complicated cases, the inheritance might start getting in the way. Here is how you can remove it using traditional delegation:

```
class StaffMemberUsingDelegation {
  private delegate = new Person()
  def salary
  def getName() {
    delegate.name
  }
  def setName(name) {
    delegate.name = name
  }
  def getAge() {
    delegate.age
  }
  def setAge(age) {
    delegate.age = age
  }
  def getNationality() {
    delegate.nationality
  }
  def setNationality(nationality) {
    delegate.nationality = nationality
  }
}
```

It looks like we have greatly increased the size of our code. This is because the earlier example was making use of Groovy's compact property notation which we can't use in this case. We should notice however, that most of this code is fairly boiler-plate in style.

Even though this example is not too bad, it becomes annoying to have to read, write and maintain this boiler-plate code. Instead, we can make use of Groovy's Meta-Programming capabilities as follows:

```
class StaffMemberUsingMOP {
  private delegate = new Person()
  private hasLocalProperty(name) {
    metaClass.properties.collect{ it.name }.contains(name)
  }
}
```

```

def salary
StaffMemberUsingMOP(Map map) {
map.each{ k, v -> setProperty(k, v) }
}
void setProperty(String name, value) {
if (hasLocalProperty(name)) this."$name" = value
else delegate.setProperty(name, value)
}
def getProperty(String name) {
if (hasLocalProperty(name)) return this."$name"
else return delegate.getProperty(name)
}
}

```

We can use the above classes with this script code:

```

def p1 = new StaffMemberUsingInheritance(name:'Tom', age:20, nationality:'French', salary:1000)
def p2 = new StaffMemberUsingDelegation(name:'Dick', age:25, nationality:'German', salary:1100)
def p3 = new StaffMemberUsingMOP(name:'Harry', age:30, nationality:'Dutch', salary:1200)
describe(p1)
describe(p2)
describe(p3)

```

With the result being:

```

Tom has a salary of 1000
Dick has a salary of 1100
Harry has a salary of 1200

```

Method Example

The above example focussed on classes that were very data centric and were implemented using properties. Let's consider the a similar example but this time with classes which are method centric.

First, we define a Person class.

```

class Person {
private name
private age
Person(name, age) {
this.name = name
this.age = age
}
def haveBirthday() { age++ }
def describe() { "$name is $age years old" }
}

```

We can use inheritance to define a staff member class as follows:

```

class StaffMemberUsingInheritance extends Person {
private salary
StaffMemberUsingInheritance(name, age, salary) {
super(name, age)
this.salary = salary
}
def describe() {
super.describe() + " and has a salary of $salary"
}
}

```

This works well here, but in complex systems the inheritance might start to complicate our system. An alternative way to implement the functionality using traditional delegation is shown here:

```

class StaffMemberUsingDelegation {
private delegate
private salary
StaffMemberUsingDelegation(name, age, salary) {

```

```

delegate = new Person(name, age)
this.salary = salary
}
def haveBirthday() {
delegate.haveBirthday()
}
def describe() {
delegate.describe() + " and has a salary of $salary"
}
}

```

The pattern here is simple, for each method in the delegate class that we want available in the staff member class, we create a method that explicitly calls the delegate. Simple but this is boiler-plate code that needs to change whenever we change the underlying classes.

So, as an alternative, we can use Groovy's Meta Object Programming facilities to auto delegate methods using `invokeMethod`:

```

class StaffMemberUsingMOP {
private delegate
private salary
StaffMemberUsingMOP(name, age, salary) {
delegate = new Person(name, age)
this.salary = salary
}
def invokeMethod(String name, args) {
delegate.invokeMethod(name, args)
}
def describe() {
delegate.describe() + " and has a salary of $salary"
}
}

```

The result in this case looks like we didn't save much code at all. If however, there were lots of methods from the delegate that we needed to use, this one wouldn't grow in size, whereas the previous approach would become larger. Also, this version will require less maintenance as we don't need to explicitly change it if the `Person` class changes over time. Note that because the `describe` method didn't follow the *boiler-plate* approach of simple delegation (because it needed extra logic), we are still required to implement that method manually.

This script code shows the various classes described above in action:

```

def p1 = new StaffMemberUsingInheritance('Tom', 20, 1000)
def p2 = new StaffMemberUsingDelegation('Dick', 25, 1100)
def p3 = new StaffMemberUsingMOP('Harry', 30, 1200)
p1.haveBirthday()
println p1.describe()
p2.haveBirthday()
println p2.describe()
p3.haveBirthday()
println p3.describe()

```

Which results in the following output:

```

Tom is 21 years old and has a salary of 1000
Dick is 26 years old and has a salary of 1100
Harry is 31 years old and has a salary of 1200

```

Further Information on this Pattern

- [Delegation Pattern](#)
- [Replacing Inheritance with Composition](#)

Security

This page last changed on Jun 10, 2007 by [glaforge](#).

Groovy is integrated with the Java security model. Groovy scripts can be compiled and executed in the presence of a SecurityManager and a Policy that dictates what permissions are granted to the script.

In a typical java environment, permissions are granted to code according to its **codeSource**. A codeSource consists of a **codebase** (essentially, the URL the code was loaded from by the class loader) and optionally the certificates used to verify the code (when it is obtained from a signed jar file). Since groovy can produce java .class files which can be loaded by existing secure class loaders (e.g. URLClassLoader), the traditional mechanisms can be used to enforce security policies without doing anything special. Setting up and running java security can be a little tricky, so consider the following resources for more information:

- [Java Security Tutorial](#)
- [Java Application Security](#)
- [Permissions in the Java 2 SDK](#)
- [Java 1.4 Security](#)
- [Java Security, 2nd Edition – O'Reilly](#)

The last of these is a book which covers the Java security model in detail.

In a typical groovy environment, there are additional considerations – often groovy scripts are loaded dynamically from some filesystem and translated *on the fly* into java class files. In other cases, groovy scripts may be entered via an interactive shell, or retrieved from a database for dynamic translation.

Filesystem based Groovy scripts

In the case where the script is read from the filesystem, groovy uses a custom class loader [GroovyClassLoader](#) that searches the CLASSPATH for .groovy files and gives them a codeSource constructed from a codebase built from the source file URL. This class loader also supports signed .jar files containing .groovy scripts so that both codebase and certificates can be used to verify the source code. Once the groovy scripts are loaded as classes, they behave just like java classes with respect to security.

Non-URL based Groovy scripts

In the case where the script has no URL, there is not necessarily any definitive way for groovy to associate an appropriate codeSource with the script. In these cases, groovy allows a codebase to be specified for the script that is being compiled (by specifying a [GroovyCodeSource](#)), subject to the caller having permission to specify that specific codebase. This codebase takes the form of a URL, but need not refer to a physical file location.

To illustrate this more clearly, consider the case where some server system is responsible for fetching and loading scripts that will be executed on behalf of a client. Assume that the server is trusted (i.e. it has permission to do anything) while the client belongs to a class of restricted clients that only (for example) have permission to access the normally restricted property "file.encoding". For this simple example, assume that the security Policy in effect has been specified by the following policy file:

```
grant codeBase "file:${server.home}/classes/-" {
  permission java.security.AllPermission;
};

grant codeBase "file:/serverCodeBase/restrictedClient" {
  permission java.util.PropertyPermission "file.encoding", "read";
};
```

The groovy script to be executed on behalf of the client is:

```
//Do some work... then access the file.encoding property:
fileEncoding = System.getProperty("file.encoding");
```

When the client calls the server and passes this script for execution, the server can evaluate it, specifying a specific codebase:

```
new GroovyShell().evaluate(new GroovyCodeSource(clientscriptStr, "RestrictedScript", "/serverCodeBase/restrictedClient")
```

In order for the server to be able to create a `GroovyCodeSource` with a specific `codeBase`, it must be granted permission by the Policy. The specific permission required is a [GroovyCodeSourcePermission](#), which the server has by implication (the policy file grant of `java.security.AllPermission`).

The net effect of this is to compile the client script with the `codeBase` `"/serverCodeBase/restrictedClient"`, and execute the compiled script. When executed, the policy file grant(s) for the `codeBase` `"/serverCodeBase/restrictedClient"` will be in effect.

Additional information

For more information, check out the security test cases in the groovy source code distribution. These tests specify a custom policy file `groovy.policy`, which is located in the security directory under the groovy-core CVS module. The class `SecurityTestSupport` (located at `src/test/groovy/security`) activates this policy by specifying it in the system property `"java.security.policy"`. Examining this policy file along with the test cases should detail the concepts discussed here.

Note that in a typical application environment, the policy would be located and activated either by using the default lookup mechanism (`policy.url.<n>` setting in `JAVA_HOME/jre/lib/security/java.security`) or as a VM argument: `-Djava.security.policy=/my/policy/file`.

Writing Domain-Specific Languages

This page last changed on Mar 31, 2008 by [glaforge](#).

Tutorial on DSLs

Guillaume Laforge and John Wilson presented a [tutorial on Groovy DSLs](#) at the QCon 2007 conference in London.

Matt Secoske presented a session on [Implementing DSLs in Groovy](#) at the OSCON 2007 conference.

Groovy features enabling DSLs

Groovy is particularly well suited for writing a DSL: [Domain-Specific Language](#). A DSL is a mini-language aiming at representing constructs for a given domain. Groovy provides various features to let you easily embed DSLs in your Groovy code:

- the [builder](#) concept lets you write tree structured languages
- you can add new methods and properties on arbitrary classes through [categories](#) or custom metaclasses, even numbers: `3.euros`, `5.days`, etc, as shown in this [article explaining how to write a unit handling mini-DSL](#)
- most [operators can be overloaded](#): `5.days + 6.hours`, `myAccount += 400.euros`
- passing maps to methods makes your code look like methods have named parameters: `move(x: 500.meters, y: 1.kilometer)`
- you can also create your own control structures by passing [closures](#) as the last argument of a method call: `ifOnce(condition) { ... }; inTransaction { ... }`
- it is also possible to add dynamic methods or properties (methods or properties which don't really exist but that can be intercepted and acted upon) by implementing [GroovyObject](#) or creating a custom [MetaClass](#)

Guillaume Laforge gave some [thoughts and examples](#) on that topic on his blog. John Wilson has implemented a DSL in his [Google Data Support](#) to make operations on dates easier.

Joachim Baumann wrote an article showing how to [implement a small DSL for measurement calculation](#), which uses some of the techniques like adding properties to numbers, or overloading operators. Guillaume Laforge also wrote an article on [representing units using the JScience library](#).

Andy Glover also plays with internal DSLs in Groovy by producing a [behavior testing DSL](#).

Inspired by an article from Bruce Tate [IBMs Alphaworks](#) a couple of samples were written in groovy.

- [Chris vanBuskirk](#) uses arrays and maps to model the injection of the state transitions.
- [Edward Sumerfield](#) uses closures to inject the state transitions.

Inspired by [RSpec](#) (and also by random episodes of Family Guy) [an example](#) of a unit testing DSL using Groovy

- [Clifton Craig](#) uses Builders in Groovy to create [GSpec](#).

When Groovy's not enough

If you have the need to write your own language completely, consider using a compiler compiler. There are many to choose from, e.g. Antlr, JavaCC, SableCC, Coco/R, Cup/JLex/JFl;ex, BYacc/J, Beaver, etc. See [wikipedia](#) for an interesting list. Some of these can even benefit from Groovy. Here is a groovy example for [JParsec](#).

Articles

This page last changed on Apr 07, 2008 by [kks_krishna](#).

Here are a bunch of articles and blog posts on all things groovy

Beginners Tutorials

- The K&R Series by Simon P. Chappell
 1. [Groovin' with Kernighan and Ritchie](#)
 2. [Groovin' with K&R 2](#)
 3. [Groovin' and Regroovin'](#)
 4. [Groovin' with K&R 4](#)
- Getting Groovy series by James Williams
[Originally a series of three articles. It has been merged into one document.]
[Getting Groovy Without the Bad Clothes](#)

James Strachan talks about Groovy

- A [collection](#) of references to articles and emails by James Strachan on the topic of Groovy.

Guillaume Laforge interviews on Groovy and Grails

- [Vanward / Stelligent interview](#)
- [IndicThreads interview](#)

General

- [Templates in Groovy](#) by JavaBeat.
- [Closures in Groovy](#) by JavaBeat.
- [Web Development in Groovy using Groovlets](#) by JavaBeat.
- [Introduction to Groovy - Scripting Language](#) by JavaBeat.
- [Using Groovy to Send Emails](#) by Paul King.
- Groovy: XML Without the Bloat by Pan Pantziarka: [Part 1](#) and [Part 2](#)
- Russel Winder gave a talk "[Builders: How MOPs Make Life Easy](#)" at ACCU 2007 which focused on the way Groovy does things.
- [Implementing Domain-Specific Languages with Groovy](#) - tutorial given by [Guillaume Laforge](#) and John Wilson at QCon 2007
- BEA Dev2Dev features an [introduction to Groovy and Grails](#)
- Scott Hickey gave a [presentation](#) about Groovy at the Omaha Java User Group, July 2006
- Russel Winder had an article introducing Groovy published in *{CVU}* **18**(3):3-7. *{CVU}* is the journal of the [ACCU](#). For more details on the article click [here](#).
- Scott Davis gave a recent [presentation](#) about Groovy even mentioning a few words about [Grails](#).
- [Groovying With the JVM](#) was a presentation given by [Russel Winder](#) at the [ACCU](#) 2006 conference.
- [It's a Groovy Day!](#) by Eric Armstrong (inspired by Rod Cope's presentation at JavaOne 2005)
- [JavaPolis 2004 presentation](#) or [video](#) from James and Dion along with a [snap of James rambling](#) 😊
- JSR 241 - Nov 2004 London Conference presentations
 - [Keynote\(mp3 - 34Mb\)](#) by James Strachan
 - [History of Groovy](#) by Jeremy Rayner
 - [User Feedback \(mp3 - 15Mb\)](#) by Guillaume LaForge
- Ian Darwin wrote [this article](#) for O'Reilly
- John Wilson gave [this presentation](#) on XML processing in Groovy at XMLOpen 2004 in Cambridge
- Ian Darwin gave [this presentation at the Toronto JUG in November]
<http://www.darwinsys.com/groovy/jugslides-20041102.pdf>]
- James Strachan and Rod Cope gave [this presentation at JavaOne 2004](#) or [as PDF](#)
- Alexander Schmid gave [this presentation](#) at the JAOO in Cannes
- Rod Cope gave [this presentation](#) at the Denver JUG
- Laurent Weichberger gave [this presentation](#) at JSPRING in the Netherlands
- Mike Spille wrote a great [review of Groovy](#)
- Ted Leung did a great [presentation at SeaJUG](#)

- Gerald Bauer did a presentation at the [Austria JUG](#) and another one [in Vancouver](#)
- Mark Volkmann has written the excellent [Groovy - Scripting in Java](#)
- An old presentation James Strachan gave at CodehausOne August 2003 is available as a [PPT](#)
- Marc Hedlund has written several very good introductory articles about getting stuff done with Groovy (especially with the SwingBuilder). The index of all his articles can be found at [O'Reilly's website](#).
- Articles from the [Practically Groovy](#) series by Andrew Glover
 - [Smooth operators](#)
- (25 Oct 2005) [Of MOPs and mini-languages](#)
- (20 Sep 2005) [Functional programming with curried closures](#)
- (23 Aug 2005) [Groovy's growth spurt](#)
- (19 Jul 2005) [Stir some Groovy into your Java apps](#)
- (24 May 2005) syntax prior to the JSR syntax [Mark it up with Groovy Builders](#)
- (12 Apr 2005) [Go server side up, with Groovy](#)
- (15 Mar 2005) [MVC programming with Groovy templates](#)
- (15 Feb 2005) [JDBC programming with Groovy](#)
- (11 Jan 2005) [Ant scripting with Groovy](#)
- (14 Dec 2004) [Unit test your Java code faster with Groovy](#)
- (09 Nov 2004) Craig Castelaz guides you through [Groovy closures](#) on java.net (syntax prior to the JSR syntax|<http://today.java.net/pub/a/today/2005/05/19/fences.html>) on java.net (syntax prior to the JSR syntax|<http://today.java.net/pub/a/today/2005/05/19/fences.html>) on java.net (syntax prior to the JSR syntax|<http://today.java.net/pub/a/today/2005/05/19/fences.html>) on java.net (syntax prior to the JSR syntax]
- If you're [getting to know Groovy](#) John Zukowski will bring you up to speed with Groovy (syntax prior to the JSR syntax)
- Matthias Luebken wrote about [Implementing OSGi-Services in Groovy](#).

References

- Jeremy Rayner has created a [Groovy reference card](#) with [latex source](#)

French articles

- [Guillaume Laforge](#) gave an [introductory presentation](#) of Groovy at the Parisian [OSS-Get Together](#) event
- Guillaume speaks about the advantage of using dynamic languages to increase the semantic density to
- [Introduction au langage de script Groovy](#) on the JDN site
- [Introduction au langage de script Groovy](#) on developpez.com
- [Intégrer JXTA dans une application Web avec JSF et Groovy](#) par Bertrand Goetzmann
- [Invoquer un service JBI \(Java Business Integration\) écrit en Groovy avec AJAX](#) par Bertrand Goetzmann

German articles

- May 2007: Joachim Baumann presented Groovy in a talk at the [Entwicklertag Karlsruhe](#). The slides can be downloaded [here](#)
- Dierk's Groovy series in JavaMagazin.

- 8.2006 **Groovy für Java-Entwickler: Dynamische Programmierung auf der Java-Plattform** [Dynamischer Nachwuchs](#)
- 9.2006 **Groovy für Java-Entwickler: Ausdruckskraft durch starke Syntax** [Klassen- und Objektnotation, Referenzierungsmöglichkeiten, Operatoren, Kontrollstrukturen und Meta-Objekt-Protokoll](#)
- 10.2006 **Groovy-Datentypen** [First class citizens: Zahlen, Strings, Reguläre Ausdrücke, Listen, Maps, Ranges und Closures](#)
- 11.2006 **Ausgewählte Groovy-Beispiele** [Groovy everywhere](#)
- 12.2006 **Grails** [Groovy für Java-Entwickler](#)
- 27.12.2006 [Interview: Groovy - das Beste aus der Java- und der Scripting-Welt vereinen](#)
- Joachim Baumann gave a [presentation](#) about Groovy in German at the "Symposium: Trends in der Informations- und Kommunikationstechnik" in Stuttgart, September 2006.
- An [article](#) by Alexander Schmid
- [Sigs Datacom article](#)
- Dierk's Groovy presentation at [JAX 2006](#) is attached as [Groovy at JAX_pub.zip](#).
- Dierk's Groovy usage patterns article in [iX Magazin 7/06](#)

Korean articles

- [Groovy Language Study](#)
- [Groovy I, Dynamic Agile Scripting Language](#) (Korean Language) by Pilho Kim
- [Groovy II, Groovlet and GSP \](#) (Korean Language) by Pilho Kim
- [Groovy III, Compare Groovy to Other Languages \](#) (Korean Language) by Pilho Kim

Russian articles

- [What is Groovy](#) - A brief introduction into Groovy language features by Vadim Voituk
- [Groovy + JSON + Prototype in Action](#) - Example of using Groovy in a 'real' project
- [Groovy: Easy extracting XML from database \(Russian edition\)](#)
- ... and [more russian Groovy articles](#)

Japanese articles

- coverage of our JavaOne talk [June 2004](#)

Spanish articles

- [Introduccion a Groovy I](#) - Introduction to Groovy part I by Andres Almiray at [Groovy.org.es](#)
- [Introduccion a Groovy II](#) - Introduction to Groovy part II by Andres Almiray at [Groovy.org.es](#)

Community and Support

This page last changed on Oct 12, 2007 by [glaforge](#).

Getting in touch

There are various ways of communicating with the Groovy community.

- subscribe to the [mailing lists](#) and take part in any conversations
- add some comments to the [wiki](#)
- blog about it and hopefully folks are subscribed to your blog 😊

Other topics:

- [Contributing](#)
- [Forums and Newsgroups](#)
- [Mailing Lists](#)
- [Related Projects](#)
- [User Groups](#)

Contributing

This page last changed on Nov 25, 2007 by [paulk_asert](#).

There are many ways you can help make Groovy a better piece of software - and we can use all the help we can get 😊 Please dive in and help!

Try surfing the documentation - if something is confusing or not clear, let us know - or better still fix it for us 😊. All of this website is maintained in [a wiki](#), so please go right ahead and fix things if they are wrong or contribute new documentation.

Download the code & try it out and see what you think. Browse the source code. Got an itch to scratch, want to tune some operation or add some feature?

Want to do some hacking on Groovy? Try surfing the [issue tracker](#) for open issues or features that need to be implemented, take ownership of an issue and try to fix it.

If you'd rather a more gentle introduction to coding on the Groovy project, how about you look at the [test coverage report](#) and help us get it even more green by supplying more test cases to get us closer to 100% coverage.

If you find a bug or problem

Please raise a new issue in our [issue tracker](#)

If you can create a JUnit test case (either via Groovy or Java code) then your issue is more likely to be resolved quicker.

e.g. take a look at some of the [existing unit tests cases](#), find one and modify it to try reproduce your problem.

Then we can add your issue to CVS and then we'll know when its really fixed and we can ensure that the problem stays fixed in future releases.

Submitting patches

We gladly accept patches if you can find ways to improve, tune or fix Groovy in some way.

Most IDEs can create nice patches now very easily. If you're a command line person try the following to create the patch

```
diff -u Main.java.orig Main.java >> patchfile.txt
```

or

```
cvcs diff -u Main.java >> patchfile.txt
```

Once you've created a patch the best way to submit it is to raise a new issue in the issue tracker (see below) and maybe send us a mail on the [developer list](#) letting us know about the patch.

Using the issue tracker

Before you can raise an issue in the issue tracker you need to register with it. This is quick & painless.

If you want to have a go at fixing an issue you need to be in the list of groovy-developers on the issue tracker. To join the group, please mail the groovy-dev mail list with the email address you used to register with the issue tracker and we'll add you to the group.

Forums and Newsgroups

This page last changed on Jan 20, 2008 by [glaforge](#).

Web forums and usenet newsgroups where you can get help. If a forum supports more than one language it is listed under its primary language. Other languages are listed in parentheses.

English

- A forum addressing Groovy and Grails.
groovy-forum.org (Chinese, Dutch, Finnish, German, French, Italian, Polish, Portuguese, Russian, Spanish)

German

- The German Groovy and Grails Forum Groovy-Forum.de

Spanish

- Spanish web forum groovy.org.es

Mailing Lists

This page last changed on Feb 01, 2008 by [ivanfontes](#).

Here are the public mailing lists that have been set up for the project. In order to subscribe/unsubscribe you first need to get a special link from http://xircles.codehaus.org/manage_email. Once you have got this link you can manage your subscriptions by going to the Groovy project page <http://xircles.codehaus.org/projects/groovy>.

announce@groovy.codehaus.org	is a low volume list for announcements about new releases or major news
dev@groovy.codehaus.org	is a medium volume list useful for those interested in ongoing developments
jsr@groovy.codehaus.org	is a low volume list discussing standardisation of the language through the JCP
scm@groovy.codehaus.org	is a high volume list that logs commits and issues
user@groovy.codehaus.org	is a high volume list is for questions and general discussion about Groovy
Portuguese / Spanish	is a list for spanish and portuguese speakers (subscribe unsubscribe archive)

You can find a great archive support on [Nabble](#) and at [MarkMail](#).

Related Projects

This page last changed on Apr 03, 2008 by [elponderador](#).

This page lists projects using Groovy in some way. Please add your project to this page.

Lightweight containers, J2EE & AOP

- [Spring's Groovy Support](#)
- [NanoContainer](#) is a script fron-tend for PicoContainer.
- [PicoContainer](#) has [Groovy Pico](#). here's an [example test case](#)
- [ServiceMix](#) is an open source JBI / ESB and has full [Groovy support](#)
- [OpenEJB](#) which has a Groovy telnet shell for querying EJBs while the server's live 😊
- [GAP](#) using Groovy [dynAop](#) and Pico
- The Turbine [Fulcrum Groovy Service](#) executes Groovy scripts managed by the Fulcrum ResourceManager Service. It provides the following features:
 - caching of Groovy scripts to improve performance
 - thread-safe execution of compiled Groovy scripts
 - seamless integration with the existing Avalon infrastructure.
- [1060 NetKernel](#) has [Groovy support](#) for creating scripted services and service orchestration.
- [GrailsFlow](#) is a Workflow and Business Process Engine written in Groovy and Grails.

Blog/Wiki, CMS, Portal projects

- [SnipSnap](#) has some nice Groovy support allowing to admins to write [GSP](#) pages.
- [XWiki](#) also comes with [GSP](#) support and has some nice examples of using it, e.g. [live RegEx testing](#).
- [biscuit](#) is an all-groovy wiki made by Groovy committer Jeremy Rayner.
- [blojsom](#)
- [WidgetWeb](#)
- [eXo Platform](#)

Web frameworks

- [NanoWeb](#)
- [RIFE](#)
- [Struts 2](#) Create Struts 2 actions in Groovy
- [Simple](#) Advanced Groovy templating, provides a lightweight version of Struts Tiles
- [Groovy Tapestry](#)
- [GvTags](#) Template engine with tag lib support for Groovy and JSP tag library
- [Woko](#): *POJOs on the Web!* Full stack DDD framework for building Object Oriented, Multi Profile webapps, with support for Groovy
- [OOWeb](#) Lightweight, fast, object-oriented web framework. Can be embedded by groovy.

Testing Tools

- [Canoo WebTest](#) allows specifying Test Steps scripted in Groovy, bundling a series of Tests Steps with the MacroStepBuilder, and creating a whole WebTest using the AntBuilder. See [GroovyWebTest](#)

Web Service Tools

- [soapui](#) Has a Groovy test step. The Groovy Script step allows you to specify an arbitrary Groovy script during the execution of a TestCase. The script has full access to the soapui object model and can thus perform a variety of tasks. Read more: [Groovy Scripts](#)

Other Server Software

- [Groovy Runner](#) is a way to run Groovy scripts (and templates) in a LAMP server setup. Use groovy the same way you use PHP.

- [GroovyConsole servlet/portlet](#) is a servlet/portlet that let you type groovy commands and executes them on the server, returning the output - useful for playing with the living e

Other

- [GroovyRules](#) is a JSR-94 compliant lightweight rules engine that permits defining rules in Groovy
- [PLEAC-Groovy](#) is an implementation of the Solutions of the Perl Cookbook in the Groovy language.
- [FreeMind](#) is a mindmapping tool that supports [scripting mindmaps with Groovy](#). Furthermore, the Groovy compiler can produce a visual representation of Groovy code as a FreeMind *.mm file. Start the compiler with the `-Dantlr.ast=mindmap` option.
- [Funkee](#) is a Groovy Scripting Host that shows a nice little smiley on your desktop that you can click to open a Groovy source code editor, or for running Groovy scripts, as well as other scripting languages.
- [GAQ](#) is a lightweight framework for developing, scheduling, running and reviewing automated tasks. It combines the scripting ease of Groovy, the power of Ant, and the cross platform scheduling of Quartz.
- [Luxor XUL](#) is an XUL language extension that comes with [Groovy Support](#).
- [Hierarchical Inherited Rule-Interpreted XML](#) is a dynamic XML Engine that creates dynamic DOMs built on dynamic rules and expressions where Groovy is available to be used as the expression interpreter.
- [JFacets](#): *the Profile Based framework*, proposes a clean and consistent solution to the recurrent "user profiling" issues (users/roles, security, personalization etc) through the concept of facets, that can be written in Groovy
- [Grails Camelot](#): an Idea Repository, and a grails showcase.
- [Groovy MDA](#) A model driven architecture tool that uses groovy. By default it can be used to generate JPA entity beans from a UML model. You can also easily add your own templates to generate other types of projects.
- [ORM Lite](#): a light ORM library in 1000 lines of Groovy code
- [mixGin](#): MixGin provides a fluent API for an easy interaction between groovy and java fragments within java code. Those code can be mixed arbitrarily, including automatic category detection and data access of variables declared in groovy within java and vice versa
- [Groovy Eclipse EMF Builder](#) Jörn Dinkla's project for using the Eclipse Modeling Framework with Groovy.
- [Disk usage tool](#) Jörn Dinkla's project for investigating the harddisk for usage information; based on Groovy and JFreeChart.
- [CHSM/Groovy](#) allows concurrent, hierarchical, state machines to be constructed using Groovy markup for modeling and controlling reactive systems.
- [Market Data Works](#) uses Groovy to customize and perform Market Data transformations.
- [Gracelets](#) An extension to the Facelets framework to allow plain groovy files to be view id's and build the view using a custom groovy builder that integrates with the FaceletHandler scheme in facelets. (See also [Forum comments](#))

User Groups

This page last changed on Apr 06, 2008 by [mirouhh](#).

[Web Forums](#) can now be found on a separate page.

Asia

- [Indian Groovy & Grail User Group](#)
- [Japan Grails/Groovy User Group](#)

Africa

- none

North America

[Vancouver Groovy and Grails User Group](#) (British Columbia, Canada)

South America

- none

Europe

- [London Groovy and Grails User Group](#)
- German user group [Special Interest Group \(SIG\) "Groovy" in der JUGS \(Java User Group Stuttgart\)](#)
- There are plans to open a second German User Group in Munich, we will use this Wiki page to inform you about first dates. So far this is the plan:
 - proposed meeting space is Actionality, Schellingstraße 45, Munich. Exit the underground station "Universität" and walk down the "Schellingstraße" to get there. Open for other places in Munich.
 - Topics would include anything around Groovy: Groovy discussions (Features), Web Frameworks using Groovy (Grails, Aero, Rife), anything you want to talk about
 - propose schedule: once a month, evening from 18:00 to 19:00 or open end - we still have to agree on exakt dates
- There is also a focus on GROOVY in the [JUGHH \(Java User Group Hamburg\)](#)
- A first meeting is coming up in [April 2008](#). Maybe this would be the first step to a user group in Hamburg.
- Check out our meeting dates. We're preparing a GROOVY and GRAILS topic for one of our next meetings.

Australia

- [Melbourne Groovy User Group](#) held at the [Aegeon](#) offices on the 1st Monday of each Month.

Cookbook Examples

This page last changed on Nov 28, 2007 by [tony_landis](#).

Larger examples of using Groovy in the Wild with a focus on applications or tasks rather than just showing off the features, APIs or modules:

- [Accessing SQLServer using groovy](#)
- [Alternate Spring-Groovy-Integration](#)
- [Auto setup and download dependencies jars](#)
- [Batch Image Manipulation](#)
- [command line groovy doc or methods lookup](#)
- [Compute distance from Google Earth Path \(in .kml file\)](#)
- [Convert SQL Result To XML](#)
- [Embedded Derby DB examples](#)
- [Embedding a Groovy Console in a Java Server Application](#)
- [Executing External Processes From Groovy](#)
- [Formatting simple tabular text data](#)
- [Groovy Alternatives to Inner Classes](#)
- [Installing or Update Groovy Automatically](#)
- [InstallTextMateGroovyBundle](#)
- [Integrating Groovy in an application - a success story](#)
- [Iterator Tricks](#)
- [Martin Fowler's closure examples in Groovy](#)
- [Other Examples](#)
- [Parsing Groovy Doc Online](#)
- [Plotting graphs with JFreeChart](#)
- [PoorMansMixins](#)
- [Reading from a Blob](#)
- [Recipes For File](#)
- [Search one or more jar files for a text string](#)
- [Simple file download from URL](#)
- [Solving Sudoku](#)
- [SwingBuilder with custom widgets and observer pattern](#)
- [Tomcat tools](#)
- [Unsign Jar Files \(Recursively\)](#)
- [Using JGoodies Animation with Groovy](#)
- [Using JScience with Groovy](#)
- [Using MarkupBuilder for Agile XML creation](#)
- [Using the Delegating Meta Class](#)
- [Using the Eclipse Modeling Framework \(EMF\)](#)
- [Using the Eclipse UML2 Framework](#)
- [Using the Proxy Meta Class](#)
- [Windows Look And Feel for groovyConsole](#)
- [WrappingGroovyScript](#)
- [Writing to a Blob](#)
- [Yaml and Groovy](#)

Additional real-world example for the german readers: <http://berndschiffer.blogspot.com/2007/03/groovy-im-fluss-ein-beispiel-aus-der.html>

A [HTTP POST & GET Helper Class for Groovy](#)

Accessing SQLServer using groovy

This page last changed on Mar 23, 2007 by rangarajan@fastmail.fm.

***DISCLAIMER:** *Use at your own risk. Author is not responsible for any damages resulting from direct or indirect use of the instructions here.

Accessing Microsoft SQLServer using Groovy

This is an example of how to access Microsoft SQL Server (2000) database using groovy to create reports on a unix box using a Microsoft JDBC driver. The instructions to install the JDBC driver itself are given in **Appendix A**. The script name is **queryMSSQL.groovy**. Assumptions are:

- The script takes as arguments one or more queryfiles and executes them against a Microsoft SQLServer 2000 database defined using options on the command line.
- host on which SQLServer resides is reachable from the unix host and that there are no firewall issues.
- All queries have one bind variable, which is satisfied by the argument to option **-v**
- USAGE: **groovy queryMSSQL.groovy -h -s sqlserverhost [-P port] -u userid -p password -v value -t textfile queryfile [queryfile]**
- Option / arguments info:
 1. **-P port** - denotes the port where SQLServer is listening
 2. **-u userid* -*** denotes userid (on SQLServer)
 3. **-p password** - denotes password for the userid on SQLServer
 4. **-v value** - value to satisfy bind variable (in a where clause eg. WHERE col = ...). If no **?** is seen in queryfile, then no bind variables are involved. In this case the value passed should be **none**.
 5. **-t textfile* *-** The name of text file where output would go
 6. queryfile - A file containing query

Bar.java

```
import java.sql.Connection
import java.sql.DriverManager
import javax.sql.DataSource
import groovy.sql.Sql

def cli = new CliBuilder( usage: 'groovy queryMSSQL.groovy -h -s sqlserverhost [-P port] -u userid
-p password -v value -t textfile queryfile [queryfile]...' )
cli.h(longOpt:'help', 'usage information')
cli.s(argName:'servername', longOpt:'server', args:1, required:true, type:GString, 'sqlserverhost')
cli.P(argName:'port', longOpt:'port', args:1, required:false, type:GString, 'port')
cli.u(argName:'userid', longOpt:'userid', args:1, required:true, type:GString, 'userid')
cli.p(argName:'password', longOpt:'password', args:1, required:true, type:GString, 'password')
cli.v(argName:'value', longOpt:'value', args:1, required:true, type:GString, 'value')
cli.t(argName:'textfile', longOpt:'text', args:1, required:true, type:GString, 'text file')
def opt = cli.parse(args)
if (!opt) return
if (opt.h) cli.usage()
def port = 1433
if (opt.P) port = opt.P // If the port was defined
def servername = opt.s
def userid = opt.u
def password = opt.p
def valuetobind = opt.v
def textfile = opt.t
def outFile
def outFileWriter
try {
outFile = new File(textfile)
outFile.write(""); // truncate if output file already exists
} catch (Exception e) {
println "ERROR: Unable to open $textfile for writing";
return;
}
driver = Class.forName("com.microsoft.jdbc.sqlserver.SQLServerDriver").newInstance();
Connection conn = DriverManager.getConnection("jdbc:microsoft:sqlserver://$servername:$port",
userid, password);
```

```

try {
if (args.length == 0) {
usage_error = "Error: Invalid number of arguments"
usage_error = "\n$usage_error\nUSAGE: groovy queryMSSQL.groovy queryfile\n"
throw new IllegalArgumentException(usage_error)
}
Sql sql = new Sql(conn)
// After options processing the remaining arguments are query files
// Go through the query files one at a time for execution
for (queryfilename in opt.arguments()) {
queryfile = new File(queryfilename)
query = "" // initialize the query string
param_count = 0 // Number of placeholders needed for parameters to query
pattern = /\?/ // pattern to look for to find number of parameters
// read the query from the query file (line by line) and build it
queryfile.eachLine { it ->
query += " " + it
}
// number of bind variables to satisfy is obtained by number of ? seen in the query
query.eachMatch(pattern) { param_count++ }
println '-.' * 40
println "query is ${query}"

println "Output is:"
println '=' * 80
def count = 0 // row count
paramlist = []
if (valuetobind != "none")
1 upto(param_count) { paramlist << valuetobind }
sql.eachRow(query, paramlist) { row ->
count++; // increment number of rows seen so far
//println "$count. ${row.name}" // print out the column name
recstr = "" // initialize the string that represents row
meta = row.getMetaData() // get metadata about the row

for (col in 0..<meta.columnCount) {
// record is stored in a string called recstr
if (recstr == "") {
recstr = row[col]
}
else {
recstr += "," + row[col]
}
}

outfile.append(recstr + "\n")
}
}
conn.close()
} catch (Exception e) {
print e.toString()
}
finally {
}
}

```

Appendix A - Installing the Microsoft JDBC driver on unix

These notes are based on instruction provided in <http://support.microsoft.com/kb/313100>.

- Download SQL Server 2000 Driver for JDBC Service Pack 3. This is done by getting the file mssqlserver.tar from Microsoft site:

<http://www.microsoft.com/downloads/details.aspx?FamilyID=07287B11-0502-461A-B138-2AA54BFDC03A&displaylang=en>

- Upload the tar file mssqlserver.tar to \$HOME/download (choose a suitable directory).

- Extract the files from mssqlserver.tar using **tar xvf mssqlserver.tar**
- Make a directory where the JDBC driver will be installed (say \$HOME/mssqljdbcsp3) using **mkdir \$HOME/mssqljdbcsp3**
- Change to \$HOME/download and run **./install.ksh**
- When prompted for the installation directory choose **\$HOME/mssqljdbcsp3**. This results in the message:
SQL Server 2000 driver for JDBC is installed in the following location: \$HOME/mssqljdbcsp3
- Set the CLASSPATH variable in the startup file (**.login** or **.profile**) to include the following jar files:
 1. \$HOME/lib/msbase.jar
 2. \$HOME/lib/mssqlserver.jar
 3. \$HOME/lib/msutil.jar

In Bourne/Korn shell CLASSPATH can be appended to using:

```
export CLASSPATH="$CLASSPATH:$HOME/lib/msbase.jar:$HOME/lib/mssqlserver.jar:$HOME/lib/msutil.jar"
```

Alternate Spring-Groovy-Integration

This page last changed on Aug 02, 2007 by [spiral](#).

Abstract

Alternate way to integrate Groovy in a Java-Application using Spring, without the usage of `<lang:groovy/>`-Tags.

Advantages

- Works with Spring-AOP
- You can use other Groovy-Classes e.g. internal datatypes, in your Beans without the need to inject them.

Example

Java Code that's create the App-Context

```
...
private GenericApplicationContext createAppContext(String path) {
    GenericApplicationContext ctx = new GenericApplicationContext();

    GroovyClassLoader defaultClassLoader = new GroovyClassLoader(this.getClass().getClassLoader());

    XmlBeanDefinitionReader reader = new XmlBeanDefinitionReader(ctx);
    reader.setBeanClassLoader(defaultClassLoader);
    reader.loadBeanDefinitions(path);
    ctx.refresh();
    return ctx;
}
...
```

Sample beans.xml

```
<bean id="tm" class="ticketing.bo.impl.TicketManagerImpl"/>
```

ticketing/bo/impl/TicketAssemblerImpl.groovy

```
class TicketAssemblerImpl implements IBaseAssembler {
    ...
}
```

Hopefully that is helpful...

Auto setup and download dependencies jars

This page last changed on Dec 19, 2007 by [thebugslayer](#).

this script [SetupGroovyLib.groovy](#) provide the following:

```
groovy SetupGroovyLib.groovy -h
```

```
Usage SetupGroovyLib jarname [jarname...]
```

```
The jarname is in format of Maven2 artifacts groupId:artifactId:version name.
```

```
You may use site like http://www.mvnrepository.com to help you find the jarname.
```

```
This script default arguments to:
```

```
javax.activation:activation:1.1
```

```
javax.mail:mail:1.4
```

```
mysql:mysql-connector-java:5.1.5
```

```
These jars will allow you to send emails and access to MySQL database!
```

NOTE: If you are using groovyConsole, you will need to restart it as it won't pick up any new jar added to ~/.groovy/lib automatically.

See also [Installing or Update Groovy Automatically](#)

More examples

Using commons-lang

Run `groovy SetupGroovyLib.groovy commons-lang:commons-lang:2.3`

Now try out:

```
import org.apache.commons.lang.*
StringUtils.splitByWholeSeparator("aXXbXXc", "XX")
```

Batch Image Manipulation

This page last changed on Sep 26, 2006 by [paulk_asert](#).

An example image manipulation script, It's not that fresh anymore but it was laying around when at the sametime some people want to see more examples. So here is my little contribution.

Note to the groovy gurus: find more groovier ways.

```
/**
 * A batch image manipulation utility
 *
 * A wrote this script just to get groovy, batch manipulate images in about
 * 240 lines of code (without this comment)!!!.
 *
 * commands:
 * values ending with '%' means size relative to image size.
 * values ending with 'px' means values in absolute pixels.
 * values without postfix use default notation.
 *
 * expressions:
 * scale(width,height)      * height is optional(use width) e.g: scale(50%) == scale(50%,50%)
 * fit(width,height)        * relative scale the image until if fits (default as scale)
 *                           * bounds of the given box, usefull for generating of thumbnails.
 * rotate(degrees,x,y)     * the rotation position x and y are optional (default is 50%)
 *
 * TODO: move(x,y)         * move the image within its own bounds (can be done with margin)
 *                           * y is optional(same height)
 * TODO: color(type)       * color transformation
 * TODO: shear(degrees,x,y) * x and y is optional
 * margin(x,y,x2,y2)      * add margins to image (resize image canvas), this operation can't
 *                           * be used on a headless environment.
 *
 * parameters:
 * -d                       * working directory (default current directory)
 * -e                       * execute expressions from command line.
 * -f                       * execute expressions from file.
 * -p                       * file mathing pattern default is \.png|\.jpg
 * -q                       * output file pattern can use {0} .. {9}
 *                           * backreferences from the input pattern. default: output/{0}
 * -h                       * help, nothing special (maybe this doc using heredoc)
 *
 * Example generate thumbnails(take *.png from images fit them in a 100X100 box,
 * add 10px margin, put them in the thumbnail dir.)
 *
 * $ groovy image.groovy -d images -e "fit(100px,100px) margin(5)" -p "(.*)\.png" -q "thumbnail/
 * {1}.png"
 *
 * @author Philip Van Bogaert alias tbone
 */

import java.io.*;
import javax.imageio.*;
import java.awt.*;
import java.awt.image.*;
import java.awt.geom.*;
import java.util.*;

class GroovyImage {
property File srcDir = new File(".");

operations = [];

property pattern = ~".*(\\.png|\\.jpg)";
property outputPattern = "output/{0}";
```

```

void addOperation(command) {

matcher = command =~ "([a-z+)\(\(.*)\).*";
matcher.find();

method = matcher.group(1);
args = matcher.group(2).split(",").toList();

switch(method) {
case "scale": // vertical, horizontal
operations.add([parseAndScale, argsLength(args, 2)]);
break;

case "rotate": // degrees, x, y
operations.add([parseAndRotate, argsLength(args, 3)]);
break;

case "margin": // left, top, right, bottom
operations.add([parseAndMargin, argsLength(args, 4)]);
break;

case "fit": // width, height
operations.add([parseAndFit, argsLength(args, 2)]);
break;
}
}

BufferedImage parseAndRotate(image, degrees, x, y) {
parsedRadians = 0;
try {
parsedRadians = Math.toRadians(Double.parseDouble(degrees));
}
catch(NumberFormatException except) {
}

parsedX = parseValue(x, image.width, true, "50%");
parsedY = parseValue(y, image.height, true, parsedX);

return rotate(image, parsedRadians, parsedX, parsedY);
}

BufferedImage rotate(image, radians, x, y) {
transform = new AffineTransform();
transform.rotate(radians, x, y);
op = new AffineTransformOp(transform, AffineTransformOp.TYPE_BILINEAR);
return op.filter(image, null);
}

BufferedImage parseAndScale(image, horizontal, vertical) {
parsedHorizontal = parseValue(horizontal, image.width, false, "100%");
parsedVertical = parseValue(vertical, image.height, false, parsedHorizontal);
return scale(image, parsedHorizontal, parsedVertical);
}

BufferedImage scale(image, horizontal, vertical) {
transform = new AffineTransform();
transform.scale(horizontal, vertical);
op = new AffineTransformOp(transform, AffineTransformOp.TYPE_BILINEAR);
return op.filter(image, null);
}

BufferedImage parseAndMargin(image, left, top, right, bottom) {
parsedLeft = parseValue(left, image.width, true, "0px");
parsedTop = parseValue(top, image.height, true, parsedLeft);
parsedRight = parseValue(right, image.width, true, parsedLeft);
parsedBottom = parseValue(bottom, image.height, true, parsedTop);
}

```



```

return margin(image, parsedLeft, parsedTop, parsedRight, parsedBottom);
}

BufferedImage margin(image, left, top, right, bottom) {
width = left + image.width + right;
height = top + image.height + bottom;
newImage = new BufferedImage(width.intValue(), height.intValue(), BufferedImage.TYPE_INT_ARGB);
// createGraphics() needs a display, find workaround.
graph = newImage.createGraphics();
graph.drawImage(image, new AffineTransform(1.0d, 0.0d, 0.0d, 1.0d, left, top), null);
return newImage;
}

BufferedImage parseAndFit(image, width, height) {
parsedWidth = parseValue(width, image.width, true, "100%");
parsedHeight = parseValue(height, image.height, true, parsedWidth);

imageRatio = image.width / image.height;
fitRatio = parsedWidth / parsedHeight;

if(fitRatio < imageRatio) {
parsedHeight = image.height * (parsedWidth/image.width);
} else {
parsedWidth = image.width * (parsedHeight/image.height);
}

return parseAndScale(image, parsedWidth+"px", parsedHeight+"px");
}

BufferedImage manipulate(image) {
for(operation in operations) {
image = operation[0].call([image] + operation[1]);
}
return image;
}

void batch() {
images = getImages();
for(imageMap in images) {
imageMap.image = manipulate(imageMap.image);
storeImage(imageMap);
}
}

Object getImages() {
imageMaps = [];

for(i in srcDir.listFiles()) {
if(!i.isDirectory()) {
subpath = i.path;
if(subpath.startsWith(srcDir.path)) {
subpath = subpath.substring(srcDir.path.length());
}
matcher = subpath =~ pattern;
if(matcher.find()) {
imageMaps.add(["file":i, "matcher":matcher]);
}
}
}
imageMaps.each({it["image"] = ImageIO.read(it["file"]); });
return imageMaps;
}

void storeImage(imageMap) {

```

```

groupIndex = 0;
name = outputPattern;
matcher = imageMap.matcher;
while(groupIndex <= matcher.groupCount()) {
name = name.replaceAll("\\\\{\\$groupIndex}\\",matcher.group(groupIndex++));
}
type = name.substring(name.lastIndexOf(".")+1,name.length());
file = new File(srcDir,name);
file.mkdirs();
ImageIO.write(imageMap.image,type,file);
}

static void main(args) {
argList = args.toList();
script = '';
groovyImage = new GroovyImage();

// command line parsing bit, NOTE: -h does System.exit(2)
argAndClosure = ['-d':{groovyImage.srcDir = new File(it)},
'-q':{groovyImage.outputPattern = it},
'-p':{groovyImage.pattern = it},
'-h':{groovyImage.help()}];
// parse non-conditional arguments
parseMultipleCommandArgs(argList,argAndClosure);

// expression,file,nothing
if(!parseCommandArg(argList,'-e', {script = it})) {
parseCommandArg(argList,'-f',{script = new File(it).text});
}

// execution bit
commands = script =~ "([a-z]{1,}\\\\"([^])*\\)";
while(commands.find()) {
groovyImage.addOperation(commands.group(1));
}
groovyImage.batch();

}

static boolean parseCommandArg(args,arg,closure) {
index = args.indexOf(arg);

if(index != -1 && index + 1 < args.size()) {
closure.call(args[index + 1]);
return true;
} else {
return false;
}
}

static void parseMultipleCommandArgs(args,argAndClosureMap) {
for(argAndClosure in argAndClosureMap) {
parseCommandArg(args,argAndClosure.key,argAndClosure.value);
}
}

void help() {
println('usage: groovy image.groovy -i <inputDir> -o <outputDir> -e "<expressions>");
System.exit(2);
}

/**
 * absolute true -> returns pixels.
 * false -> returns relative decimal (e.g 1.0).
 */
Number parseValue(value,size,absolute,defaultValue="0") {

```

```

pattern = "(-?[0-9]+\\.?.?[0-9]*)(.*)";
matcher = value =~ pattern;
if(!matcher.find()) {
matcher = defaultValue =~ pattern;
matcher.find();
}

decimalValue = Double.parseDouble(matcher.group(1));
type = matcher.group(2);

if(absolute) { // pixels
switch(type) {
case "%":
return (int) size * (decimalValue / 100);
case "px":
default:
return (int) decimalValue;
}
}
else { // scale
switch(type) {
case "px":
return decimalValue / size;
case "%":
return decimalValue / 100;
default:
return decimalValue;
}
}
}

Object argsLength(args,length) {
if(args.size() < length) {
while(args.size() < length) {
args.add("");
}
} else {
args = args.subList(0,length);
}
return args;
}
}

```

command line groovy doc or methods lookup

This page last changed on Nov 06, 2007 by [thebugslayer](#).

The attached script can lookup both Java and Groovy's meta methods and quickly display the method signatures.

Usage and Examples

Help

```
$ groovy gdoc
usage gdoc className -- display all public methods signatures.
usage gdoc package.className -- same as above with full package prefix.
usage gdoc className methodName -- display only methods that match this name.
```

All public methods

```
groovy gdoc File
equals
public boolean java.lang.Object.equals(java.lang.Object)
public boolean java.io.File.equals(java.lang.Object)
getClass
public final native java.lang.Class java.lang.Object.getClass()
hashCode
public native int java.lang.Object.hashCode()
public int java.io.File.hashCode()
notify
public final native void java.lang.Object.notify()
notifyAll
public final native void java.lang.Object.notifyAll()
toString
public java.lang.String java.lang.Object.toString()
public java.lang.String java.io.File.toString()
wait
public final void java.lang.Object.wait() throws java.lang.InterruptedException
public final native void java.lang.Object.wait(long) throws java.lang.InterruptedException
public final void java.lang.Object.wait(long,int) throws java.lang.InterruptedException
canRead
public boolean java.io.File.canRead()
canWrite
public boolean java.io.File.canWrite()
compareTo
public int java.io.File.compareTo(java.io.File)
public volatile int java.io.File.compareTo(java.lang.Object)
createNewFile
public boolean java.io.File.createNewFile() throws java.io.IOException
createTempFile
public static java.io.File java.io.File.createTempFile(java.lang.String,java.lang.String) throws
java.io.IOException
public static java.io.File
java.io.File.createTempFile(java.lang.String,java.lang.String,java.io.File) throws
java.io.IOException
delete
public boolean java.io.File.delete()
deleteOnExit
public void java.io.File.deleteOnExit()
exists
public boolean java.io.File.exists()
getAbsolutePath
public java.io.File java.io.File.getAbsolutePath()
getAbsolutePath
public java.lang.String java.io.File.getAbsolutePath()
getCanonicalFile
public java.io.File java.io.File.getCanonicalFile() throws java.io.IOException
```

```

getCanonicalPath
public java.lang.String java.io.File.getCanonicalPath() throws java.io.IOException
getName
public java.lang.String java.io.File.getName()
getParent
public java.lang.String java.io.File.getParent()
getParentFile
public java.io.File java.io.File.getParentFile()
... many more...

```

Filter method names(ones from JDK built-in)

```

$ groovy gdoc File list
list
public java.lang.String[] java.io.File.list()
public java.lang.String[] java.io.File.list(java.io FilenameFilter)
listFiles
public java.io.File[] java.io.File.listFiles()
public java.io.File[] java.io.File.listFiles(java.io FileFilter)
public java.io.File[] java.io.File.listFiles(java.io FilenameFilter)
listRoots
public static java.io.File[] java.io.File.listRoots()

```

Filter method names(ones from Groovy's Dynamic methods)

```

$ groovy gdoc File each
eachFile
public static void
org.codehaus.groovy.runtime.DefaultGroovyMethods.eachFile(java.io.File, groovy.lang.Closure) throws
java.io.FileNotFoundException, java.lang.IllegalArgumentException
each
public static java.lang.Object
org.codehaus.groovy.runtime.DefaultGroovyMethods.each(java.lang.Object, groovy.lang.Closure)
eachFileMatch
public static void
org.codehaus.groovy.runtime.DefaultGroovyMethods.eachFileMatch(java.io.File, java.lang.Object, groovy.lang.Closure)
throws java.io.FileNotFoundException, java.lang.IllegalArgumentException
eachLine
public static void
org.codehaus.groovy.runtime.DefaultGroovyMethods.eachLine(java.io.File, groovy.lang.Closure) throws
java.io.IOException
eachObject
public static void
org.codehaus.groovy.runtime.DefaultGroovyMethods.eachObject(java.io.File, groovy.lang.Closure)
throws java.io.IOException, java.lang.ClassNotFoundException
eachDirRecurse
public static void
org.codehaus.groovy.runtime.DefaultGroovyMethods.eachDirRecurse(java.io.File, groovy.lang.Closure)
throws java.io.FileNotFoundException, java.lang.IllegalArgumentException
eachFileRecurse
public static void
org.codehaus.groovy.runtime.DefaultGroovyMethods.eachFileRecurse(java.io.File, groovy.lang.Closure)
throws java.io.FileNotFoundException, java.lang.IllegalArgumentException
eachDir
public static void
org.codehaus.groovy.runtime.DefaultGroovyMethods.eachDir(java.io.File, groovy.lang.Closure) throws
java.io.FileNotFoundException, java.lang.IllegalArgumentException
eachByte
public static void
org.codehaus.groovy.runtime.DefaultGroovyMethods.eachByte(java.io.File, groovy.lang.Closure) throws
java.io.IOException
eachDirMatch
public static void
org.codehaus.groovy.runtime.DefaultGroovyMethods.eachDirMatch(java.io.File, java.lang.Object, groovy.lang.Closure)
throws java.io.FileNotFoundException, java.lang.IllegalArgumentException
eachWithIndex

```

```
public static java.lang.Object
org.codehaus.groovy.runtime.DefaultGroovyMethods.eachWithIndex(java.lang.Object, groovy.lang.Closure)
```

Using package prefix(any things that's outside of Groovy's default imports.)

```
groovy gdoc groovy.sql.Sql each
eachRow
public void groovy.sql.Sql.eachRow(groovy.lang.GString, groovy.lang.Closure) throws
java.sql.SQLException
public void groovy.sql.Sql.eachRow(java.lang.String, groovy.lang.Closure) throws
java.sql.SQLException
public void groovy.sql.Sql.eachRow(java.lang.String, groovy.lang.Closure, groovy.lang.Closure) throws
java.sql.SQLException
public void groovy.sql.Sql.eachRow(java.lang.String, java.util.List, groovy.lang.Closure) throws
java.sql.SQLException
each
public static java.lang.Object
org.codehaus.groovy.runtime.DefaultGroovyMethods.each(java.lang.Object, groovy.lang.Closure)
eachWithIndex
public static java.lang.Object
org.codehaus.groovy.runtime.DefaultGroovyMethods.eachWithIndex(java.lang.Object, groovy.lang.Closure)
```

Compute distance from Google Earth Path (in .kml file)

This page last changed on Aug 16, 2007 by [marcdexet](#).

Every Google Earth user is going mad about path and distance: you can get Path or Distance but not both.

This little snippet help you to get path AND distance.

1. Create your path as usual with Google Earth
2. Save it as a .kml file (not .kmz)
3. Run the this script

```
/**
 * Compute distance in Google Earth KML path file from a path
 * @author Marc DEXET ( marcdexet [at] gmail [dot] org )
 */
class Point {
def lat
def lon
public Point(){}

public Point(String gps) {
def xyz = gps.tokenize(',')
lat = Double.parseDouble( xyz[1] )
lon = Double.parseDouble( xyz[0] )
}
public String toString() {
return "LAT: ${lat} LON: ${lon}"
}

public static double distance(Point p0, Point p1) {
return Haversine.compute(p0, p1)
}
}

/**
 * List of Points
 */
class PointList {
def points
def distance
def partiels = []

public PointList( List points ) {
this.points = points
compute()
}

void compute() {
def nbPointList = points.size()
distance = 0;
partiels = []
for( idx in 1..(nbPointList-1) ) {
def p0 = points[(idx-1)]
def p1 = points[idx]
def dist = Point.distance(p0,p1)
partiels << dist
distance = distance+dist
}
}

}
/**
 * Haversine algorithmus
 * (thanks to http://www.movable-type.co.uk/scripts/latlong.html)
 */
class Haversine {
```

```

static double R = 6371

static double compute(Point p1, Point p2) {
def dLat = Math.toRadians(p2.lat-p1.lat);
def dLon = Math.toRadians(p2.lon-p1.lon);
def a = Math.sin(dLat/2) * Math.sin(dLat/2) +
Math.cos( Math.toRadians(p1.lat) ) *
Math.cos( Math.toRadians(p2.lat) ) * Math.sin(dLon/2) * Math.sin(dLon/2);
def c = 2 * Math.atan2(Math.sqrt(a), Math.sqrt(1-a));
def d = R * c;
return d
}

}

class KmlParser {
static ns = new groovy.xml.Namespace("http://earth.google.com/kml/2.1", 'ns')

List parse( Object input ) {
def kml = new groovy.util.XmlParser().parse( input );
def coords = kml[ ns.Document ][ ns.Placemark ][ ns.LineString ][ ns.coordinates ].value[0]
def myList = coords.tokenize();
def points = []
myList.each{ gestring -> points << new Point(gestring) }
return points;
}
}

// Application

def kmlParser = new KmlParser()
def points = kmlParser.parse( args[0] )
def PointList pointList = new PointList( points )
def partiels = pointList.partiels;
def distance = pointList.distance;

java.text.DecimalFormat f = new java.text.DecimalFormat( "0.000" );
java.text.DecimalFormat n = new java.text.DecimalFormat( "00" );
println "Distance totale: ${f.format(distance)} km"
partiels.eachWithIndex { d, i ->
println "${n.format(i)} ${f.format(d)} km"
}
}

```

Convert SQL Result To XML

This page last changed on Dec 07, 2006 by [marcdexet](#).

How to convert SQL Result to XML ?

```
import groovy.sql.Sql
import groovy.xml.MarkupBuilder
def schema = "PROD"
def sql = Sql.newInstance("jdbc:oracle:thin:@hostname:1526:${schema}", "scott", "tiger",
"oracle.jdbc.driver.OracleDriver")

/* Request */
def req = """
SELECT id, name, givenname, unit FROM ${schema}.people
WHERE
in_unit=1
AND visible=0
"""
def out = new File('out.xml')
def writer = new FileWriter( out )
def xml = new MarkupBuilder( writer )

xml.agents {
sql.eachRow( req as String ) {
/* For each row output detail */
row ->
xml.agent(id:row.id) {
name( row.name )
givenname( row.givenname )
unit( row.unit )
}
}
}
```

Output is

```
<agents>
<agent id='870872'>
<name>ABTI</name>
<givenname>Jean</givenname>
<unit>Sales</unit>
</agent>
...
</agents>
      <!-- xml.agents { -->
      <!-- agent(id:row.id) { -->
      <!-- name( row.nom ) -->
      <!-- givenname( row.prenom ) -->
      <!-- unit( row.unite ) -->
      <!-- } -->
```

Embedded Derby DB examples

This page last changed on Jan 11, 2007 by raffaele.castagno@gmail.com.

Be sure that derby.jar is in the classpath before running this example.

This will create derby.log and derbyDB folder in the folder where the script is.

If something goes wrong, simply remove derbyDB folder, and everything will be clean for next run.

```
import groovy.sql.*
import java.sql.*

protocol = "jdbc:derby:";
def props = new Properties();
props.put("user", "user1");
props.put("password", "user1");

def sql = Sql.newInstance(protocol + "derbyDB;create=true", props);

/* Creating table, adding few lines, updating one */
sql.execute("create table people(id int, name varchar(40), second_name
varchar(40), phone varchar(30), email varchar(50))");

println("Created table 'people'");

sql.execute("insert into people values (1,'John', 'Doe', '123456','johndoe@company.com')");
sql.execute("insert into people values (2,'Bill', 'Brown', '324235','billbrown@company.com')");
sql.execute("insert into people values (3,'Jack', 'Daniels', '443323','jackdaniels@company.com')");

println("Inserted people");

sql.execute("update people set phone='443322', second_name='Daniel''s'where id=3");

println("Updated person");

/* Simple query */
def rows = sql.rows("SELECT * FROM people ORDER BY id");
rows.each {println it}

/* Dropping table 'people' */
sql.execute("drop table people")
println ("Table 'people' dropped")

try{
DriverManager.getConnection("jdbc:derby:;shutdown=true")
}
catch (SQLException se){
gotSQLException = true
}

println("Finish!")
```

Embedding a Groovy Console in a Java Server Application

This page last changed on Jun 05, 2007 by bruce@iterative.com.

The following example of using Groovy to execute arbitrary code in a running web application is excerpted from a [longer article](#) originally posted to [Bruce Fancher's blog](#). The code and examples can be downloaded from [here](#).

In order to add the GroovyServer to the application, I added the following lines to the Spring applicationContext.xml file:

appContext.xml

```
<bean id="shirtService" class="org.pimpmyshirt.service.ShirtServiceImpl" />

<bean id="contextWrapper" class="org.pimpmyshirt.spring.ApplicationContextWrapper" />

<bean id="groovyService" abstract="true" init-method="initialize" destroy-method="destroy">
<property name="bindings">
<map>
<entry key="context" value-ref="contextWrapper" />
<entry key="shirtService" value-ref="shirtService" />
</map>
</property>
</bean>

<bean id="groovyShellService" class="com.iterative.groovy.service.GroovyShellService"
parent="groovyService">
<property name="socket" value="6789" />
<property name="launchAtStart" value="true" />
</bean>

<bean id="groovyConsoleService" class="com.iterative.groovy.service.GroovyConsoleService"
parent="groovyService" />
```

You'll note that there are actually two Groovy-related services. The first one, `groovyShellService`, is the networked wrapper around the `InteractiveShell`. The second one, `groovyConsoleService`, is a wrapper around the `GroovyConsole`, which is a Swing-based application that provides essentially the same facility as the `InteractiveShell`, but in an application with a nice GUI. Since only the `GroovyShellService` allows remote access to an application it is focus of this article. But if you're running the server application on the same machine you're developing on, you can hit the URL <http://localhost:8080/pimpmyshirt/launchGroovyConsole.html>, which will trigger a simple Spring web controller to launch an instance of the `GroovyConsole`. Just note that for some reason exiting the `GroovyConsole` will cause Tomcat to exit, but since I mostly use the `GroovyShellService`, and this is only intended for development and testing purposes, I haven't bothered to try and find out why this is.

Both services inherit from the `groovyService` abstract bean, which includes bindings for the `shirtService`, which is a service included in the PimpMyShirt application that we'll explore with Groovy, and an instance of `ApplicationContextWrapper`, which is a class that implement's Springs `ApplicationContext` and `ApplicationContextAware` interfaces. The `ApplicationContextWrapper` is given a reference to the Spring application context through the `ApplicationContextAware` interface, and delegates all of `ApplicationContext`'s methods to this instance. I did this because I didn't want the `GroovyServices` to be dependent on Spring, and while there might very well be a simpler way to pass an instance of the application context to a bean without implementing `ApplicationContextAware`, I don't know what it is.

After building the application with the included ant script, a war file is produced that it should be possible to deploy to any J2EE application server (although I've only tested it with Tomcat). Once it's deployed and launched, the first thing to do is to connect to the web application at <http://hostname:8080/pimpmyshirt/index.html> and enter some ratings for the shirts, in order to have some data in the application before we test it:

[\(view as slideshow\)](#)

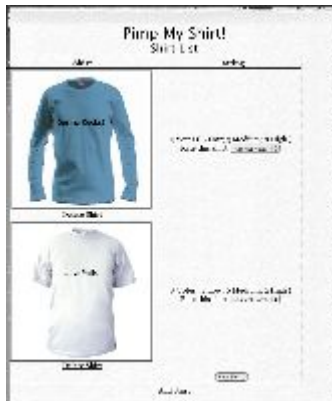

Now we can connect to the GroovyServer and run some code to display the application's state. As configured, the application will launch the server on port 6789 when it starts, so assuming the application is running on the same machine you're sitting in front of, you can connect to it by just opening a shell and typing telnet localhost 6789. What you'll see is exactly what you'd get if you were to run groovysh on it's own:

```
Let's get Groovy!
=====
Version: 1.0 JVM: 1.5.0_07-87
Type 'exit' to terminate the shell
Type 'help' for command help
Type 'go' to execute the statements
```

```
groovy>
```

We can now issue commands to the interpreter and see the results:

```
def shirts = shirtService.getAllShirts();

shirts.each() {
def shirtRating = shirtService.getRating(it);
out.println "Color: ${it.color}, Long Sleeve: ${it.longSleeve}, Graphical: ${it.print.graphical},
Text: ${it.print.text}, Low Votes: ${shirtRating.numberOfLowVotes}, Medium Votes:
${shirtRating.numberOfMediumVotes},
High Votes: ${shirtRating.numberOfHighVotes}"
}

go

Color: WHITE, Long Sleeve: false, Graphical: false, Text: JavaPolis, Low Votes: 1, Medium Votes: 0,
High Votes: 2
Color: BLUE, Long Sleeve: true, Graphical: false, Text: Spring Rocks!, Low Votes: 0, Medium Votes:
3, High Votes: 0
```

This code uses a Groovy closure to iterate over the ratings for available shirts and prints out the stats for each one. I won't explain Groovy syntax in detail as I go through these examples, since full documentation on programming in Groovy can be found on the Groovy web site. However, before going further I need to point out one difference between executing Groovy in this environment compared to its typical usage. You'll note that in the above example I've used "out.println" instead of just "println," as is usually the case in Groovy code. This is because in normal Groovy "println" writes to System.out,

and in a server application, System.out is usually redirected to a log file, which is not where we usually want the output of our scripts to go. To work around this, the GroovyShellService passes in the socket's OutputStream bound to the token "out." So to print to the interactive console, we need to use "out.println" instead of just "println." Although there are other ways to work around this problem, which might be more transparent from the point of view of a user of the shell, I've chosen to do it this way since it's the easiest to implement, and the most explicit with regards to what's actually happening under the covers.

Note that since we've configured the GroovyServer in the Spring application context to have a binding to "shirtService," it's already available to us. If we hadn't done so, we could've also gotten a reference to the service from the application context by prepending the following to the code snippet above:

```
def shirtService = context.getBean("shirtService");
```

We can also call methods on the Spring application context to see, for example, what beans are available:

```
context.getBeanDefinitionNames().each() { out.println it };
go
```

```
shirtService
contextWrapper
groovyService
groovyShellService
groovyConsoleService
```

```
====> null
```

And in addition to the application services that are defined in the Spring context, we can also interrogate the web and application server layers to see how they're configured. For example, we could get the ServletContext from Spring and display its attribute names and values:

```
def servletContext = context.getServletContext();
```

```
Enumeration e = servletContext.getAttributeNames();
while (e.hasMoreElements()) {
  def attributeName = e.nextElement();
  out.println "${attributeName}: ${servletContext.getAttribute(attributeName)} \n";
}
go
```

```
org.apache.catalina.jsp_classpath: /usr/local/apache-tomcat-5.5.23/webapps/pimpmysshirt/WEB-INF/
classes/
/usr/local/apache-tomcat-5.5.23/webapps/pimpmysshirt/WEB-INF/lib/commons-collections-3.1.jar
(etc . . .)
```

```
javax.servlet.context.tempdir: /usr/local/apache-tomcat-5.5.23/work/Catalina/localhost/pimpmysshirt
```

```
org.springframework.web.servlet.FrameworkServlet.CONTEXT.pimpmysshirt:
org.springframework.web.context.support.XmlWebApplicationContext: display name
[WebApplicationContext for
namespace 'pimpmysshirt-servlet']; startup date [Mon Apr 30 01:52:03 EDT 2007]; child of
[org.springframework.web.context.support.XmlWebApplicationContext: display name [Root
WebApplicationContext];
startup date [Mon Apr 30 01:52:02 EDT 2007]; root of context hierarchy; config locations
[classpath:org/pimpmysshirt/service/applicationContext.xml]]; config locations [/WEB-INF/
pimpmysshirt-servlet.xml]
```

```
interface org.springframework.web.context.WebApplicationContext.ROOT:
org.springframework.web.context.support.XmlWebApplicationContext: display name [Root
WebApplicationContext];
startup date [Mon Apr 30 01:52:02 EDT 2007]; root of context hierarchy; config locations
[classpath:org/pimpmysshirt/service/applicationContext.xml]
```

```
org.apache.catalina.resources: org.apache.naming.resources.ProxyDirContext@fc1695
```

```
org.apache.catalina.WELCOME_FILES: {"index.html", "index.htm", "index.jsp"}
```

```
====> null
```

We can see from this output that Spring's `WebApplicationContext`, in which the servlets that Spring uses to provide hooks into its web framework are defined is bound to the `ServletContext`'s `"org.springframework.web.servlet.FrameworkServlet.CONTEXT.pimpmyshirt"` attribute. If we wanted a list of which beans were configured in the `WebApplicationContext`, we could print them out by doing the following:

```
def servletContext = context.getServletContext();
def servletAppContext =
servletContext.getAttribute("org.springframework.web.servlet.FrameworkServlet.CONTEXT.pimpmyshirt");
servletAppContext.getBeanDefinitionNames().each() { out.println it };
go

viewResolver
messageSource
multipartResolver
/index.html
/image.html
flowController
composeShirt
composeShirtAction
/launchGroovyConsole.html
```

We could also explore further, and get an instance of the `RateShirts` view from Spring's `ViewResolver`:

```
def servletContext = context.getServletContext()
def servletAppContext =
servletContext.getAttribute("org.springframework.web.servlet.FrameworkServlet.CONTEXT.pimpmyshirt");
def viewResolver = servletAppContext.getBean("viewResolver");
def view = viewResolver.buildView("RateShirts");
view
go

====> org.springframework.web.servlet.view.JstlView: name 'RateShirts'; URL [/WEB-INF/jsp/
RateShirts.jsp]
```

Or we could get an instance of the `RateShirts` web controller and view the contents of its model data after it's initialized:

```
def servletContext = context.getServletContext();
def servletAppContext =
servletContext.getAttribute("org.springframework.web.servlet.FrameworkServlet.CONTEXT.pimpmyshirt");
def rateShirtsController = servletAppContext.getBean("/index.html");
rateShirtsController.getModel()
go

====> {shirtRatings=[org.pimpmyshirt.domain.ShirtRating@6ebc80,
org.pimpmyshirt.domain.ShirtRating@198a2f],
ratings=[Lorg.pimpmyshirt.domain.Rating;@88b2fa]}
```

Obviously this is a sample application with a single service that doesn't do very much, so there isn't that much more we can do with it that would be all that interesting. However, for a real application with dozens or more services that were reasonably complex, it shouldn't be hard to imagine the usefulness of being able to interact with them to test their functionality and experiment with using them.

Executing External Processes From Groovy

This page last changed on Apr 17, 2008 by [paulk_asert](#).

Goal: execute a program via a command line from groovy code

Option 1: executing a string

A string can be executed in the standard java way:

```
def command = ""executable arg1 arg2 arg3"" // Create the String
def proc = command.execute() // Call *execute* on the string
proc.waitFor() // Wait for the command to finish

// Obtain status and output
println "return code: ${proc.exitValue()}"
println "stderr: ${proc.err.text}"
println "stdout: ${proc.in.text}" // *out* from the external program is *in* for groovy
```

Gotchas: Take care if you wish to pass a quoted argument that contains white space – it will be split into multiple arguments, e.g.:

```
""executable "first with space" second"".execute()
```

will invoke executable with the following arguments:

- arg1 = "first
- arg2 = with
- arg3 = space"
- arg4 = second

In such a case, you may prefer to use one of the array or list of String variations, e.g.:

```
["executable", "first with space", "second"].execute()
```

Option 2: using ant builder's exec task

Ant has an exec task and it be accessed from the AntBuilder object

```
def ant = new AntBuilder() // create an antbuilder
ant.exec(outputproperty:"cmdOut",
errorproperty: "cmdErr",
resultproperty:"cmdExit",
failonerror: "true",
executable: /opt/myExecutable') {
arg(line:"""first with space* second""")
}
println "return code: ${ant.project.properties.cmdExit}"
println "stderr: ${ant.project.properties.cmdErr}"
println "stdout: ${ ant.project.properties.cmdOut}"
```

The good thing is that you now have all the ant features at your disposal and Ant will not break up quoted args containing whitespace.

See also: [Process Management](#)

Formatting simple tabular text data

This page last changed on Jan 03, 2007 by raffaele.castagno@gmail.com.

Formatting simple tabular text data

This class has been posted first time on the Groovy-User Mailing List by Raffaele Castagno in this format:

```
class TableTemplateFactory
{
def columns = []; // contains columns names and their length
def header1 = ''; // contains columns names
def header2 = ''; // contains underscores
def body = ''; // the rows of the table
def footer = ''; // actually unused: can contain footer notes, totals, etc.

def addColumn(name, size)
{
columns << [name:name, size:size];
}

def getTemplate()
{
header1 = "\n";
columns.each{ header1 += ' <%print "'+it.name+'".center('+it.size+')%> ' };
header2 = "\n";
columns.each{ header2 += ' <%print "_"*'+it.size+' %> ' };
body = '\n<% rows.each {%>';
// If a value is longer than given column name, it will be truncated
columns.each{body += ' ${it.'+it.name+'.toString().padRight('+it.size+').substring(0,'+it.size
+')} '};
body += '\n<% } %>';
return header1 + header2 + body + footer;
} }

```

and later "groovyfied" by Gavin Grover:

```
class TableTemplateFactory{
def columns = []
def addColumn(name, size) { columns << [name:name, size:size]; this }
def getTemplate() { ""
${columns.collect{ " <%print \"\${it.name}\".center(\${it.size})%> " }.join()}
${columns.collect{ " <%print \"_\"*\${it.size} %> " }.join()}
<% rows.each {%>${columns.collect{ " \${it.\${it.name}.toString().padRight(\${it.size}).substring(0,
\${it.size})} " }.join()}
<% } %>""
}
}

```

First version is here only as an example of the "groovyfy process". Of course, the Gavin's version is better.

This class emulate the output of most RDBMS consoles (ie. Oracle SQL*, MySql).

Here's an usage example (again, grooved up by Gavin):

```
import groovy.text.Template; import groovy.text.SimpleTemplateEngine
def ttf = new TableTemplateFactory().addColumn("name", 15).addColumn("age", 4)
def names = [] << [name:"Raffaele", age:"23"] << [name:"Griorgio", age:"30"]
def binding = ['rows': names]
println new SimpleTemplateEngine().createTemplate(ttf.template).make(binding).toString()

```

This is the output:

```
name      age

```

Raffaele	23
Giorgio	30

Actually is really limited: column width must be declared, and strings are truncated to that given size.

Wish-list:

- Automatic column width based on maximum string length
- Multiline records
- Multiline fields
- More formatting options (alignment, case, etc)
- Management of footer fields (totals, formulae, etc)
- Automatic line-wrap based on screen size

Groovy Alternatives to Inner Classes

This page last changed on Nov 02, 2007 by [paulk_asert](#).

Groovy 1.0 and 1.1 do not support normal Java inner classes (you can have such classes only in Scripts or you can code them in Java of course).

In many cases though, you don't need them. Here is a Groovy 1.1 example which shows you how to construct a class on the fly which implements several interfaces. This would be a prime example where you would typically use an inner class in Java. In Groovy we don't have to:

```
import groovy.swing.SwingBuilder
import static java.awt.BorderLayout.*
import java.awt.event.*

// set up variables
count = 0
def textlabel
def text = "Actions: "
def update = { c ->
text += c
textlabel.text = text
}

// create the listener
def closureMap = [
mousePressed: { update 'M' },
keyPressed: { update 'K' },
focusLost: { update 'F' },
windowIconified: { update 'W' }
]
def interfaces = [WindowListener, KeyListener, MouseListener, FocusListener]
def listener = ProxyGenerator.instantiateAggregate(closureMap, interfaces)

// now the GUI
def swing = new SwingBuilder()
def frame = swing.frame(title:'Frame') {
borderLayout()
textlabel = label(text:text, constraints: NORTH)
button = button(text:'Click Me', constraints: SOUTH)
}
frame.addWindowListener listener
['Key', 'Mouse', 'Focus'].each {
button."add${it}Listener" listener
textlabel."add${it}Listener" listener
}
frame.pack()
frame.show()
```

Installing or Update Groovy Automatically

This page last changed on Dec 19, 2007 by [thebugslayer](#).

Do you need to install or update Groovy? Try java [InstallGroovy](#) `groovy-binary-1.5.0.zip`, this is a simple java program to download, unzip and link a Groovy binary release package into your /opt local system. The source code is also [attached](#).

NOTE: the class file is compiled with Java 1.5, so you will need at least that to run it. I think Groovy currently support Java 1.4 though, oh well, you just can't get everything. Can you?

Also see [Auto setup and download dependencies jars](#)

InstallTextMateGroovyBundle

This page last changed on Dec 07, 2007 by [thebugslayer](#).

```
#!/usr/bin/env groovy

/**
 * Download and setup TextMate Bundle for groovy. Assume you have svn and groovy already installed.
 * @author Zemian Deng
 * @since Thu Nov 15 15:02:11 EST 2007
 */

path = System.properties['user.home']+"/Library/Application Support/TextMate/Bundles"
dir = new File(path)
if(!dir.exists()){
println "Creating path ${path}"
dir.mkdirs()
}

println "Checking out groovy bundle..."
proc = "svn co http://macromates.com/svn/Bundles/trunk/Bundles/Groovy.tmbundle".execute(
["LC_CTYPE=en_US.UTF-8"],
dir
)
proc.waitFor()
println proc.text

println "Verifying groovy bundle..."
dir.list().each{f-> println f}
```

Integrating Groovy in an application - a success story

Introduction

As I read in the Groovy user mailinglist that some people complained missing information about how to integrate Groovy into Java applications, I decided to give one example of how we integrated Groovy as extension language for our graphical developer tool.

First a bit of background regarding the application to be scripted:

It is a little SDE GUI for starting different build targets for different components in a workarea. As we noticed that, depending on some individual tasks or different roles a developer takes in a team, extension and customisation would be a nice feature, we integrated Groovy as scripting language used to plug in individual features at the user site.

The solution in overview

Extension points in the GUI:

We created two "extension points" in the GUI: An empty "user" menu ready to be filled with items and an empty panel at the bottom of the GUI being able to be filled with e.g. custom buttons.

There is also a specific script output window, where the script can place messages or other textual output. The opening of this window is part of the API (see point 2).

Integration point:

To keep the Groovy integration at one location, we created the class ScriptConnector, which is the adaptor between Groovy and the application.

It calls the Groovy engine, maintains the binding, provides some API methods to be called inside the Groovy script, leading to better separation which keeps the script clean from the application's intera.

BTW: One requirement was, that errors in the Groovy integration should not break the rest of the application, but should only affect the customised parts, so exceptions are caught and shown as 'warnings' in a dialog window.

One plugin script:

The plugin feature is provided by one dedicated plugin script which is customisable/extensible by the user. He can use all features the Groovy language provides, so external scripts and programs can be integrated via this script.

Coming to details

Let us have a look at the main class first, so you will see it all from startup on. Please be aware that the shown source is a simplified form of our productive code.

The application main class

```
// The main application class
```

```

public class SDEGui {

public static void main(String[] args) {
SDEGui sdegui = new SDEGui();
sdegui.startGui();
}

private void startGui() {
....
final SDEGuiWindow window = SDEGuiWindow.getInstance(); // Create the whole "GUI"
window.show();

Workspace workarea = SettingManager.getCurrentWorkspace(); // Create the workarea, the object to
be scripted
....

// starting the Groovy interpreter
try {
startScript(workarea, window);
}
catch (Exception e) {
JOptionPane.showMessageDialog(window, "Exception in groovy script connection: " + e.getMessage(),
"Groovy-error", JOptionPane.WARNING_MESSAGE);
}
}

// Starts the standard Groovy script to setup additional (customised) gui elements
private void startScript(final Workspace workarea, final SDEGuiWindow window) {

ScriptConnector connector = new ScriptConnector(workarea, window); // instantiate the
connector ...
connector.runGuiComponentScript("plugins.groovy"); // ... and run the
plugin script

window.show();
}
}

```

The script connector

Now let's look at the ScriptConnector, as this is the important place of Groovy integration:

```

....
import groovy.lang.Binding;
import groovy.util.GroovyScriptEngine;
import groovy.util.ResourceException;
import groovy.util.ScriptException;
....

public class ScriptConnector {
Binding binding; // The 'binding' makes instances of the application objects available as
'variables' in the script
SDEGuiWindow window; // The main application window, the GUI in general
String[] roots; // A list of directories to search for Groovy scripts (think of it as a
PATH).

public ScriptConnector(Workspace workarea, SDEGuiWindow window) {
roots = new String[]{System.getProperty("user.home"), "." }; // The root list is filled with
the locations to be searched for the script
Binding scriptenv = new Binding(); // A new Binding is created ...

scriptenv.setVariable("workarea", workarea); // ... and filled with two 'variables': the workarea
to work on
scriptenv.setVariable("SDE", this); // and the current ScriptConnector instance
as API provider.

```

```

this.binding = scriptenv;
this.window = window;
}

// Method to show Groovy related errors/warnings in a dialog window.
public void showWarning(String message) {
JOptionPane.showMessageDialog(window, message, "Groovy-error", JOptionPane.WARNING_MESSAGE);
}

// This is the main method called from the application code to start the Groovy integration
public void runGuiComponentScript(String filename) {
GroovyScriptEngine gse = null;
try {
gse = new GroovyScriptEngine(roots); // instanciating the script engine ...
} catch (IOException ioe) {
ioe.printStackTrace();
showWarning("I/O-Exception in starting Groovy engine. Message is:\n"
+ ioe.getMessage()
+ "\n" + prepareStackTrace(ioe));
}

if (gse != null) {
try {
gse.run(filename, binding); // ... and running the specified script
} catch (ResourceException re) {
re.printStackTrace();
showWarning("ResourceException in calling groovy script '" + filename +
" Message is:\n" +re.getMessage()
+ "\n" + prepareStackTrace(re));
} catch (ScriptException se) {
se.printStackTrace();
showWarning("ScriptException in calling groovy script '" + filename +
" Message is:\n" +se.getMessage()
+ "\n" + prepareStackTrace(se));
}
}
}

// prepare a stacktrace to be shown in an output window
private String prepareStackTrace(Exception e) {
Throwable exc = e;
StringBuffer output = new StringBuffer();
collectTraces(exc, output);
if (exc.getCause() != null) {
exc = exc.getCause();
output.append("caused by:\n");
output.append(exc.getMessage());
output.append("\n");
collectTraces(exc, output);
}
return output.toString();
}

private void collectTraces(Throwable e, StringBuffer output) {
StackTraceElement[] trace = e.getStackTrace();
for (int i=0; i < trace.length; i++) {
output.append(trace[i].toString());
output.append("\n");
}
}
}

```

```

// ----- API to be used inside scripts -----

// create a new dialog to display textual output from running scripts
public ScriptOutputDialog newOutputDialog(String title, String tabTitle) {
return window.newOutputDialog(title, tabTitle);
}

// get the panel instance prepared to contain customised GUI elements, e.g. buttons
public DynamicPanel getDynpanel() {
return window.getDynamicPanel();
}

// get the user menu instance to add custom items and submenus to.
public JMenu getUsermenu() {
return window.getSDEUserMenu();
}

// create a process to run a shell command in a given directory
public Process exec(String command, File inDir) {
Process proc = null;
try {
proc = Runtime.getRuntime().exec(command, null, inDir);
} catch (Exception e) {
displayExecError(e.toString());
}
return proc;
}

// create a process to run a shell command
public Process exec(String command) {
Process proc = null;
try {
proc = Runtime.getRuntime().exec(command);
} catch (Exception e) {
displayExecError(e.toString());
}
return proc;
}

private void displayExecError(String message) {
ScriptOutputDialog win = window.newOutputDialog("Groovy Error", "Error during exec");
win.addTabPane("error");
win.println("error", message);
}
}

```

Customisation: The script plugin.groovy

This is only an (senseless) example of how to create custom buttons and menu items, but in combination with the connector class it will give you an idea of how an application can be customised/scripted with Groovy as scripting language.

```

import groovy.swing.SwingBuilder

// -- declare standard elements --
allButtons = []
allItems = []
builder = new SwingBuilder()

// USER CODE ----->

// custom methods doing the different tasks

def runDoSomething() {

```



```

def outp = SDE.newOutputDialog("Plugin-Window")
outp.show()
dir = workarea.workdir
Thread.start() {
outp.println ("=== ${dir}" )
def proc = SDE.exec("doSomething.bat", new File("${dir}") )
outp.useInputStream(proc.in)
proc.waitFor()
}
outp.println("end")
}
}

def showLogfile() {
def outp = SDE.newOutputDialog("Plugin-Window")
outp.show()
def logfile = new File("logfile.txt")
logfile.eachLine{ line ->
outp.println(line)
}
}

// user gui elements

allButtons << builder.button( text: 'Do Something', actionPerformed: { runDoSomething() } )
allButtons << builder.button( text: 'showLogfile', actionPerformed: { showLogfile() } )

allItems << builder.menuItem( text: 'TestItemOne', actionPerformed: { /* more code, you know ...
*/ } )
allItems << builder.menuItem( text: 'TestItemTwo', actionPerformed: { /* ... here too ... */ } )

// < ----- USER CODE

// ----- add custom gui elements to the dynamic panel and user menu -----
allButtons.each { SDE.dynpanel.add(it) }
allItems.each { SDE.usermenu.add(it) }

```

I hope this spontaneous little article could give you a help in Groovy application integration and give a slight idea of what Groovy could do for you.

Iterator Tricks

This page last changed on Aug 13, 2007 by [kenbloom](#).

One useful Groovy iterator is the `SyncIterator`, based on Ruby's `SyncEnumerator` which can iterate across several data structures at the same time. It makes use of `DefaultTypeTransformation.asCollection()` to perform the same coercion that Groovy uses by default to implement methods such as `each()`, `collect()`, and the like...

```
import org.codehaus.groovy.runtime.typehandling.DefaultTypeTransformation;

public class SyncIterator implements Iterator, Iterable{
private theobjects

SyncIterator(Object[] objects){
theobjects=objects.collect{
if (it instanceof Iterator) return /*from closure*/ it
else return /*from closure*/ DefaultTypeTransformation.asCollection(it).iterator()
}
}

boolean hasNext(){
return theobjects.any{it.hasNext()}
}
Object next(){
if (!hasNext()) throw new java.util.NoSuchElementException()
return theobjects.collect{
try{
return /*from closure*/ it.next()
}catch(NoSuchElementException e){
return /*from closure*/ null
}
}
}

Iterator iterator(){
return this;
}

void remove(){
throw new UnsupportedOperationException("remove() not supported")
}
}
```

Another useful iterator is the `Generator`, which takes a closure and offers up the stuff it yields as an iterator, without having to keep all of the generated data around in memory. (It's based loosely on Ruby 1.9's `Generator`, which was also the challenge in [Ruby Quiz #66](#))

```
//JAVA CODE
import java.util.concurrent.*;
import java.lang.ref.*;
import groovy.lang.Closure;
import java.util.*;

public class Generator<T> implements Iterator<T>, Iterable<T>{
Semaphore availSemaphore=new Semaphore(0);
Semaphore emptySemaphore=new Semaphore(1);

//the thread can push one value at a time into pushedValue
T pushedValue=null;

//pull value moves it from pushedValue to pulledValue
//until it is released by next()
T pulledValue=null;
boolean hasPulledValue=false;
```

```

Thread internalThread;

Generator(Closure closure){
    internalThread=new GeneratorThread<T>(this,closure);
    internalThread.setDaemon(true);
    internalThread.start();
}

private void pullValue(){
    availSemaphore.acquireUninterruptibly();
    pulledValue=pushedValue;
    pushedValue=null;
    hasPulledValue=true;
    emptySemaphore.release();
}

public boolean hasNext(){
    if (!hasPulledValue)
        pullValue();
    return emptySemaphore.availablePermits() != 2;
}

public T next(){
    if (!hasNext())
        throw new NoSuchElementException("Closure has no more values");
    T retval=pulledValue;
    hasPulledValue=false;
    return retval;
}

public void remove(){
    throw new UnsupportedOperationException(
        "Remove is not supported on generators");
}

public Iterator<T> iterator(){
    return this;
}

public void finalize(){
    internalThread.interrupt();
}

static class GeneratorThread<T> extends Thread{
    WeakReference<Generator<T>> generatorRef;
    Closure closure;
    public GeneratorThread(Generator<T> generator, Closure cl){
        generatorRef=new WeakReference<Generator<T>>(generator);
        closure=cl;
    }

    public void run(){
        closure.call(new SaveClosure<T>(this));
        Generator generator=generatorRef.get();

        //NOTE: when the closure completes, pullValue() will block forever
        //waiting for more available data. This release() allows it to
        //get in one last time, and read a variable indicating that the
        //thread has died and isn't producing any more data. one final
        //pullValue() run will have emptySemaphore==1 and
        //availSemaphore==1, and it will make emptySemaphore==2 thus
        //indicating that the thread has died
        if (generator!=null){
            generator.availSemaphore.release();
        }
    }
}

```

```

//NOTE: if the generator has been garbage collected, we don't care
//about letting the generator pull a termination condition.
}
}

static class SaveClosure<T> extends Closure{
WeakReference<Generator<T>> generatorRef;
Semaphore emptySemaphore;
Semaphore availSemaphore;
public SaveClosure(GeneratorThread<T> gt){
super(gt,null);
generatorRef=gt.generatorRef;
Generator<T> generator=generatorRef.get();
if (generator!=null){
emptySemaphore=generator.emptySemaphore;
availSemaphore=generator.availSemaphore;
}else{
throw new GeneratorDisposedException();
}
}

public void doCall(T value){
try{
emptySemaphore.acquire();
}catch(InterruptedException e){
throw new GeneratorDisposedException();
}
Generator<T> generator=generatorRef.get();
if (generator!=null){
generator.pushedValue=value;
}else{
throw new GeneratorDisposedException();
}
availSemaphore.release();
}
}

/**
 * A GeneratorDisposedException is used to terminate the thread
 * that was generating values, once the Generator has been garbage
 * collected.
 */
static public class GeneratorDisposedException extends RuntimeException{
}
}

```

Note that Groovy doesn't have this concept built in. Its MethodClosure to Iterator conversion loads everything into an array all at once, which isn't a particularly good idea you may be running find() on it, and only need to generate the first item to find what you're looking for.

For example, consider the following use of a Generator:

```

//generates an infinite sequence of Fibonacci numbers
def fibonacci(Closure yield){
def a=0
def b=1
def temp
while(true){
yield(b)
temp=a
a=b
b=a+temp
}
}

//find the first Fibonacci number that's evenly divisible by 20

```

```
println(new Generator(this.&fibonacci).find{ it % 20 == 0})
```

```
//BROKEN: the groovy runtime wants to run fibonacci to termination loading values into an array.  
//this generates an out of memory error.  
this.&fibonacci.find{it % 20 == 0}
```

As the Groovy runtime implements this now, you would exhaust all available ram when converting the MethodClosure to an iterator, before find() was ever called. With a Generator, values are only generated on demand.

NOTE: because of the use of threads, the generator may generate one more value than is actually needed before the garbage collector disposes of the generator.

Martin Fowler's closure examples in Groovy

This page last changed on Oct 06, 2007 by [paulk_asert](#).

[Martin Fowler](#) wrote an [article in his Bliki](#) on [Closures](#). He uses Ruby as demonstration language for closures. On this page (nearly) the same example is written in Groovy:

```
def managers(emps) {
  emps.findAll { e -> e.isManager() }
}

def highPaid(emps) {
  threshold = 150
  emps.findAll { e -> e.salary > threshold }
}

def paidMore(amount) {
  { e -> e.salary > amount }
}

def highPaid = paidMore(150)
println highPaid(emps[0])

new File(filename).withReader{ reader -> doSomethingWith(reader) }
```

The whole example with class *Employee* (with an dispensible, but convenient, because boosting readability, *toString()* method), an example list with four employees and some explaining assertions (Dierk would call this *Inline Unittests*):

```
class Employee {
  def name, salary
  boolean manager
  String toString() { return name }
}

def emps = [new Employee(name:'Guillaume', manager:true, salary:200),
  new Employee(name:'Graeme', manager:true, salary:200),
  new Employee(name:'Dierk', manager:false, salary:151),
  new Employee(name:'Bernd', manager:false, salary:50)]

def managers(emps) {
  emps.findAll { e -> e.isManager() }
}

assert emps[0..1] == managers(emps) // [Guillaume, Graeme]

def highPaid(emps) {
  threshold = 150
  emps.findAll { e -> e.salary > threshold }
}

assert emps[0..2] == highPaid(emps) // [Guillaume, Graeme, Dierk]

def paidMore(amount) {
  { e -> e.salary > amount }
}
def highPaid = paidMore(150)

assert highPaid(emps[0]) // true
assert emps[0..2] == emps.findAll(highPaid)

def filename = 'test.txt'
new File(filename).withReader{ reader -> doSomethingWith(reader) }

def readersText
def doSomethingWith(reader) { readersText = reader.text }

assert new File(filename).text == readersText
```

Other Examples

This page last changed on Sep 26, 2006 by [paulk_asert](#).

Some examples and snippets:

- [Scripts](#)
- [Unit tests](#)
- [GroovyAnt](#)
- [GroovySwing](#)
- [Make a builder](#)

Parsing Groovy Doc Online

This page last changed on Aug 05, 2007 by [standtrooper](#).

Contributing to online documentation website <http://gotapi.com>, we have to generate a xml document describing groovy objects and methods hierarchy and links to javadoc.

This is done with the following groovy script and the excellent HTML parser NekoHTML (see <http://people.apache.org/~andyc/neko/doc/index.html>)

```
package free.cafekiwi.gotapi;
import groovy.xml.MarkupBuilder
/**
 * @author Marc DEXET
 **/
class XmlGotApiGenerator {

    static void main(args) {
        def writer = new FileWriter( new File('gotapi.xml'))
        def xml = new MarkupBuilder(writer)
        def pages = []

        def apidocRoot = 'http://groovy.codehaus.org/api'
        def parser = new JavaDocParser();

        def methodNameFilter = {
            anchor ->
            def name = anchor.'@name'
            name != null && name.indexOf('(') >=0
        }

        def packageFilter = {
            anchor ->
            def url = anchor.'@href'
            url != null && url.endsWith( "/package-frame.html")
        }

        def classFilter = {
            anchor ->
            def url = anchor.'@href'
            url != null && ! url.contains ('/')
        }

        def parseAndGet = {
            url, filter ->
            parser.parse( url ).depthFirst().A.findAll( filter )
        }

        parseAndGet("$apidocRoot/overview-frame.html", packageFilter).each {

            def packBaseURL = it.'@href' - "/package-frame.html"
            def packPage = new Page( title: packBaseURL.replace('/', '.'),
            type: 'package',
            url: "${apidocRoot}/${it.'@href'}"
            );

            pages << packPage
            println "PackPAGE ${packPage}"

            parseAndGet( packPage.url, classFilter).each {

                def url = it.'@href'
                def fullUrl = "${apidocRoot}/${packBaseURL}/${url}"
                def fqN = url.replace('/', '.')- ".html"
                def parts = fqN.tokenize('.')
            }
        }
    }
}
```



```

def classPage = new Page( title: fqn ,
type: 'class',
url: fullUrl
);

packPage.children << classPage

println "Class PAGE: ${classPage}"

parseAndGet( classPage.url, methodNameFilter ).each {
def methodeName = it.'@name'
def methodPage = new Page(          title: methodeName ,
type: 'method',
url: classPage.url+'#'+methodeName);
classPage.children << methodPage
println "Method PAGE: ${methodPage}"
}
}
}
xml.pages() {
pages.each{
packIt ->
xml.page(title: packIt.title , type: packIt.type, url: packIt.url) {
packIt.children.each {
classIt ->
xml.page(title: classIt.title , type: classIt.type, url: classIt.url) {
classIt.children.each {
methodIt ->
xml.page(title: methodIt.title , type: methodIt.type, url: methodIt.url)
}
}
}
}
}
}
println 'END'
}
}

class Page {
def title
def type
def url
def children = []
public String toString() {
"Titre: ${title} Type: ${type} URL:${url} \n\t ${children.collect{it.toString()+' \n\t' }}"
}
}

class JavaDocParser {
def parser
/* Constructor */
JavaDocParser() {
def nekoparser = new org.cyberneko.html.parsers.SAXParser()
nekoparser.setFeature('http://xml.org/sax/features/namespace', false)
parser = new XmlParser(nekoparser);
}

def parse(url) {
return parser.parse(url)
}
}

```

Plotting graphs with JFreeChart

This page last changed on Jun 21, 2007 by [paulk_asert](#).

Inspired by the excellent [BeanShell example](#), here is the same thing in Groovy (but displaying in a Swing window rather than writing to a file):

```
//require(groupId:'jfree', artifactId:'jfreechart', version:'1.0.5')
//require(groupId:'jfree', artifactId:'jcommon', version:'1.0.9')
import org.jfree.chart.ChartFactory
import org.jfree.chart.ChartPanel
import org.jfree.data.general.DefaultPieDataset
import groovy.swing.SwingBuilder
import java.awt.*
import javax.swing.WindowConstants as WC

def piedataset = new DefaultPieDataset()
piedataset.setValue "Apr", 10
piedataset.setValue "May", 30
piedataset.setValue "June", 40

def options = [true, true, true]
def chart = ChartFactory.createPieChart("Pie Chart Sample",
piedataset, *options)
chart.setBackgroundPaint = Color.white
def swing = new SwingBuilder()
def frame = swing.frame(title:'Groovy PieChart',
defaultCloseOperation:WC.EXIT_ON_CLOSE) {
panel(id:'canvas') { widget(new ChartPanel(chart)) }
}
frame.pack()
frame.show()
```

Here is the result:

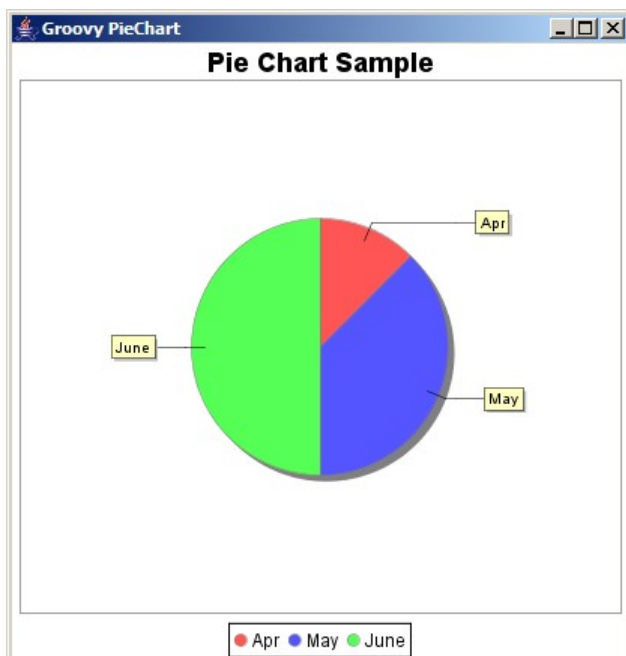

Or if you prefer [Line Charts](#):

```
//require(groupId:'jfree', artifactId:'jfreechart', version:'1.0.5')
//require(groupId:'jfree', artifactId:'jcommon', version:'1.0.9')
import org.jfree.chart.ChartFactory
import org.jfree.chart.ChartPanel
import org.jfree.data.category.DefaultCategoryDataset
```

```

import org.jfree.chart.plot.PlotOrientation as Orientation
import groovy.swing.SwingBuilder
import javax.swing.WindowConstants as WC

def dataset = new DefaultCategoryDataset()
dataset.addValue 150, "no.1", "Jan"
dataset.addValue 210, "no.1", "Feb"
dataset.addValue 390, "no.1", "Mar"
dataset.addValue 300, "no.2", "Jan"
dataset.addValue 400, "no.2", "Feb"
dataset.addValue 200, "no.2", "Mar"

def labels = ["Bugs", "Month", "Count"]
def options = [true, true, true]
def chart = ChartFactory.createLineChart(*labels, dataset,
Orientation.VERTICAL, *options)
def swing = new SwingBuilder()
def frame = swing.frame(title:'Groovy LineChart',
defaultCloseOperation:WC.EXIT_ON_CLOSE) {
panel(id:'canvas') { widget(new ChartPanel(chart)) }
}
frame.pack()
frame.show()

```

And the result looks like:

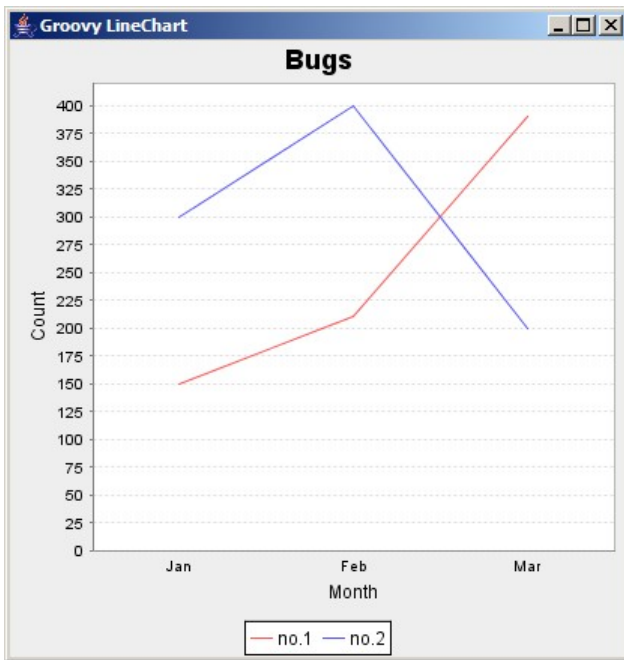

Additionally, you might have a look at the [GroovyChart library](#) which provides a dedicated builder interface for building charts.

PoorMansMixins

This page last changed on Jul 10, 2007 by ld@ldaley.com.

 In order to prevent confusion with officially supported mixin mechanisms that may be added to Groovy in the future, I have used the term 'gynamo' instead of 'mixin'. It is in essence trying to provide the same functionality.

Gynamo is a lightweight mechanism for extending classes with discrete packages of functionality similar to mixins in languages like Ruby.

Terms

To make things easier (hopefully) to understand, the following is a definition of terms used:

- Gynamee - A class that will be or has been Gynamized with a Gynamo
- Gynamo - A class that extends the gynamo.Gynamo abstract base class and specifies functionality that will be injected into to Gynamees
- Gynamize - The process of injecting the functionality specified by a Gynamo into a Gynamee

Example

An example Gynamee

```
class Square
{
def size
}
```

An example Gynamo

```
import gynamo.*
class AreaGynamo extends Gynamo
{
def getArea = {->
return delegate.size * delegate.size
}
}
```

Gynamization

```
import gynamo.*

Gynamo.gynamize(Square, AreaGynamo)

def s = new Square(size: 10)
assert s.area == 100
```

Hopefully that illustrates the point.

Download

- [Gynamo 1.0](#) (contains source)

You can also grab the buildable source from the [SVN repository](#).

Gynamo is released under the same license terms as Groovy.

Documentation

All classes in the Gynamo library are in the package "gynamo".

Gynamos can contain fields (which will be public when injected) and methods (which Gynamos define as closures). All methods and properties are attached via [ExpandoMetaClass](#) so all the usual rules apply there.

Methods and properties are attached via the '=' operator so any existing methods or properties with a matching name will be overridden. This is something to watch out for.

Writing a Gynamo

A Gynamo is any class that extends the `Gynamo` class. Gynamo inheritance is not supported, all Gynamos must directly extend the `Gynamo` class.

Methods (as closures) or fields to be injected must be accessible via getters. Groovy makes this too easy by generating getters for any fields that you don't specify the visibility of.

```
import gynamo.*
class SomeGynamo extends Gynamo
{
// Will become a public field on Gynamees
def afield

// Will become the method printSomething() on Gynamees.
def printSomething = {->
println "something"
}
}
```

You can even add fields and methods statically to a class ...

```
import gynamo.*
class SomeGynamo extends Gynamo
{
// Will become a public static field on the Gynamee's class
static aStaticField

// Will become the method aStaticMethod on the Gynamee's class.
static aStaticMethod = {->
// method code here
}
}
```

Gynamizing

The `Gynamo` class defines the static method `gynamize` which takes a Gynamee class and a Gynamo class and performs the injection.

```
import gynamo.*
Gynamo.gynamize(GynameeClass, GynamoClass)
```

Or alternatively using categories ...

```
import gynamo.*

use (Gynamo) {
GynameeClass.gynamize(GynamoClass)
}
```

Pre and Post Gynamize hooks

If your Gynamo needs to do anything before or after Gynamization of a class there are optional hooks for it

```
import gynamo.*
class SomeGynamo extends Gynamo
{
```

```

void preGynamize(Class clazz)
{
// Could instrospect clazz and throw exceptions if there it shouldn't be Gynamized with this Gynamo
}

// ... some properties or methods to copy here ...

void postGynamize(Class clazz)
{
// Could set any default values on clazz here or do anything else
}
}

```

Gynamo Properties

Sometimes you want to add bean like properties to a Gynamee. This is a little awkward but you can make it work using the provided `GynamoPropertyStorage` class. Another caveat is that you have to define the getter and/or setter for each such property. Here is an example ...

```

import gynamo.*
class SomeGynamo extends Gynamo
{
def getObjectProperty = {->
return GynamoPropertyStorage[delegate].objectProperty
}

def setObjectProperty = {
GynamoPropertyStorage[delegate].objectProperty = it
}

static getStaticProperty = {->
return GynamoPropertyStorage[delegate].staticProperty
}

static setStaticProperty = {
GynamoPropertyStorage[delegate].staticProperty = it
}
}

```

`GynamoPropertyStorage` is pretty simple. It contains a synchronized [WeakHashMap](#). Take a look at the [source](#) for details.

You would use the above like so ...

```

import gynamo.*

use(Gynamo) {
SomeClass.gynamize(SomeGynamo)
}

def o1 = new SomeClass()
def o2 = new SomeClass()

o1.objectProperty = "o1"
o2.objectProperty = "o2"

assert o1.objectProperty == "o1"
assert o1.objectProperty == "o2"

// Can't use property notation with static properties added dynamically due to groovy bug
SomeClass.setStaticProperty("static")
assert SomeClass.getStaticProperty() == "static"

```

Gynamo dependencies

If you have a gynamo that depends on another Gynamee being injected then you can specify that with annotations ...

```
import gynamo.*
@GynamoDependency(SomeOtherGynamo)
class SomeGynamo extends Gynamo
{
  ...
}
```

The `@GynamoDependency` annotation takes a single parameter of type `Class` which must be another Gynamo. The specified Gynamo will be injected automatically ***before*** this Gynamo gets injected. Therefore, the methods and fields of the dependency are available on the Gynamee at time of Gynamization.

If your Gynamo depends on multiple Gynamos, you can use the `@GynamoDependencies` annotation to specify a list of Gynamos that need to be injected before.

```
import gynamo.*
@GynamoDependencies([SomeOtherGynamo, SomeOtherOtherGynamo])
class SomeGynamo extends Gynamo
{
  ...
}
```

Note: Be careful of circular dependencies. The dependency handling is pretty simple so if you do have a circular dependency, your code will blow up with a `StackOverflowError`. If anyone has any suggestions on how this can be improved please let me know.

Reading from a Blob

This page last changed on May 18, 2007 by [sberka](#).

Reading a Blob!

Note: tested with Oracle DB 9.x and a thin driver 9.x !

```
import groovy.sql.Sql

println "---- A working test of writing and then reading a blob into an Oracle DB ----"
sql = Sql.newInstance("jdbc:oracle:thin:@pignut:1521:TESTBNDY", "userName",
"paSSword", "oracle.jdbc.OracleDriver")

rowTest = sql.firstRow("select binarydata from media where mediaid = 11122345")
blobTest = (oracle.sql.BLOB)rowTest[0]

byte_stream_test = blobTest.getBinaryStream()
if( byte_stream_test == null ) { println "Test: Received null stream!" }

byte[] byte_array_test = new byte[10]
int bytes_read_test = byte_stream_test.read(byte_array_test)

print "Read $bytes_read_test bytes from the blob!"

sql.connection.close()
```

Uses a table:

```
CREATE TABLE MEDIA
(
MEDIAID NUMBER(22) NOT NULL,
BINARYDATA BLOB NOT NULL
);

CREATE SEQUENCE SEQ_MEDIAID
INCREMENT BY 1
START WITH 100
ORDER;
```

Copying A Blob to A File!

```
...
byte_stream_test = blobTest.getBinaryStream()
if( byte_stream_test == null ) { println "Test: Received null stream!" }

blob_size = blobTest.length()
println "Blob size: $blob_size"

byte[] byte_array_test = new byte[blob_size]
int bytes_read_test = byte_stream_test.read(byte_array_test)
println "Read $bytes_read_test from the blob!"

// Write to a file
def fos= new FileOutputStream('c:\\Jornada\\auxil\\output.jpg')
fos.write(byte_array_test);
fos.close()
...
```

Groovy recipes for every day!

Today is the **File** Day !

List my imported packages

Today: I get a list of imported package into my old groovy scripts !

```
//Pattern for groovy script
def p = ~/.*groovy/
new File( 'd:\\scripts' ).eachFileMatch(p) {
f ->
// imports list
def imports = []
f.eachLine {
// condition to detect an import instruction
ln -> if ( ln =~ '^import .*' ) {
imports << "${ln - 'import '}"
}
}
// print thmen
if ( ! imports.empty ) {
println f
imports.each{ println "  $it" }
}
}
```

Output

```
D:\groovy getImports.groovy
d:\scripts\testCom.groovy
org.codehaus.groovy.scriptom.ActiveXProxy
d:\scripts\testDurableSubscriber.groovy
javax.jms.*;
org.apache.activemq.ActiveMQConnectionFactory;
org.apache.activemq.command.ActiveMQTopic;
d:\scripts\testJmsBroker.groovy
javax.jms.*;
org.apache.activemq.ActiveMQConnectionFactory;
org.apache.activemq.command.ActiveMQTopic;
```

Clean old files

today: Oh jeez! I get on my SysAdmin's nerves, file System /data is full! .. I have to clean all these useless daily reports !

```
def yesterday = ( new Date() ).time - 1000*60*60*24

def cleanThem = { prefix ->
new File('/data/waporwaresystem/reports').eachFileMatch( ~".*${prefix}.xml" ) { f ->
if ( f.lastModified() <= yesterday ) {
f.delete()
}
}
}

['sales-carambar_', 'stock-scoubidou_', 'stock_freztagad_',
'coffee.vs.tea_stats_'].each( cleanThem )
```

Saved! My SysAdmin loves me, it's sure 😊

Recursively deleting files and directories.

Today is a recursive day ! We have a bunch of files and directories to delete, let's go!

the Ant way

Don't forget this old java swiss knife...

```
new AntBuilder().delete(dir: "D:/tmp/test")
```

the Groovy Way

```
// Create a ref for closure
def delClos

// Define closure
delClos = { println "Dir ${it.canonicalPath}";
it.eachDir( delClos );
it.eachFile {
println "File ${it.canonicalPath}";
it.delete()
}
}

// Apply closure
delClos( new File("D:/tmp/test") )
```

Search one or more jar files for a text string

This page last changed on Aug 21, 2007 by jimruley@gmail.com.

This script searches one or more jar or zip files for a specified text string.

```
import java.util.jar.*

/**
 * Searches entries (file name and directory, if any) in one or more named
 * compressed (jar/zip) files, or in all compressed files in a named directory.
 * To specify a search that includes special characters, like a period, use
 * a backslash: \.xml
 */
if( args.size() < 2){
println "Required parameters: searchString filePath [filePath]\n"
println "NOTE: filePath may be a directory, which will search all jar/zip"
println "      files in all subdirectories"
return
}
def searchstr = args[0]
args[1..-1].each{searchInputFile(searchstr, new File(it))}

def searchInputFile(text, inputFile){
def filePattern = ~/*.*(jar|zip)$/
if(inputFile.isDirectory()){
inputFile.eachFileRecurse{
if(!it.isDirectory() && it.getName() =~ filePattern)
searchCompressedFile(text, it)
}
}else{
if(inputFile.getName() =~ filePattern){
searchCompressedFile(text, inputFile)
}
}
}

def searchCompressedFile(text, file){
try{
new JarFile(file).entries().each{ entry ->
if ( entry.name =~ text){
println "\n$entry.name : $file.canonicalPath"
}
}
}catch(Throwable t){
println "\nFailed to open $file.canonicalPath: ${t.toString()}"
}
}
```

Simple file download from URL

This page last changed on Jan 20, 2007 by [paulk_asert](#).

This method takes a string containing the URL of the file to be downloaded. It will create a file in the current folder whose name is the same as the remote file.

```
def download(address)
{
def file = new FileOutputStream(address.tokenize("/")[ -1])
def out = new BufferedOutputStream(file)
out << new URL(address).openStream()
out.close()
}
```

If proxy configuration is needed, call this:

```
System.properties.putAll( ["http.proxyHost": "proxy-host", "http.proxyPort": "proxy-
port", "http.proxyUserName": "user-name", "http.proxyPassword": "proxy-passwd" ] )
```

before the call.

Here is another approach using categories. The default left shift operators acts on text streams only. This category overrides the left shift operator making it a binary copy and uses the URL type as the source for the data.

```
package tests.io;

class FileBinaryCategoryTest extends GroovyTestCase
{
void testDownloadBinaryFile()
{
def file = new File("logo.gif")

use (FileBinaryCategory)
{
file << "http://www.google.com/images/logo.gif".toURL()
}

assert file.length() > 0

file.delete()
}
}

class FileBinaryCategory
{
def static leftShift(File a_file, URL a_url)
{
def input
def output

try
{
input = a_url.openStream()
output = new BufferedOutputStream(new FileOutputStream(a_file))

output << input
}
finally
{
input?.close()
output?.close()
}
}
}
```

Solving Sudoku

This page last changed on Oct 30, 2006 by [paulk_asert](#).

This page describes a Groovy solution for [ShortestSudokuSolver](#). Check the link for all the details, but basically the puzzle state is fed in as a String. Each line of the script must be no more than 80 characters in length.

The solution (184 characters plus 2 newlines):

```
def r(a){def i=a.indexOf(48);if(i<0)print a else(('1'..'9')-(0..80).collect{j->
g={(int)it(i)==(int)it(j)};g{it/9}|g{it%9}|g{it/27}&g{it%9/3}?a[j]:'0'}).each{
r(a[0..<i]+it+a[i+1..-1])}}
```

Notes:

- The script could be 25 characters shorter if Groovy supported integer division.
- The script executes more efficiently if you use logical operators '&&' and '||' instead of '&' and '||' because short-circuiting kicks in at the expense of 3 characters.
- The script would be 1 character longer if for clarity you wanted to use '0' instead of the first 48.
- The script would be 2 characters longer if you want to use `println` rather than `print` if you are fussy about the formatting
- To make the function stop as soon as it finds the first solution (proper puzzles will only have one solution), the part before the `else` becomes `{print a;System.exit(1)}`

Add the following line to the script to solve a partially complete puzzle (should take just a few seconds):

```
r '200375169639218457571964382152496873348752916796831245900100500800007600400089001'
```

Alternatively, add the following line to the script to solve a puzzle from scratch (may take 30-60 minutes or more):

```
r '200370009009200007001004002050000800008000900006000040900100500800007600400089001'
```

The expected output is:

```
284375169639218457571964382152496873348752916796831245967143528813527694425689731
```

Here is the more usual representation of the puzzle:

2			3	7				9
		9	2					7
		1			4			2
	5					8		
		8				9		
		6					4	
9			1			5		
8					7	6		
4				8	9			1

You can run it from the command-line by adding `;r args[0]` to the end of the script (saved in a file called `sudoku.groovy`) and then invoking:

```
> groovy sudoku.groovy
200370009009200007001004002050000800008000900006000040900100500800007600400089001
```

If you use `.groovy` as your script file extension, you can even leave off the extension as follows:

```
> groovy sudoku 200370009009200007001004002050000800008000900006000040900100500800007600400089001
```

A slightly longer version using a matcher and no inner closure (209 characters plus 2 newlines):

```
def r(a){def m=a~'0';if(m.find()){int i=m.start();(('1'..'9')-(0..80).collect{
```

```
j->int q=j/9,r=i/9,u=q/3,v=r/3,w=j%9/3,x=i%9/3;q==r||j%9==i%9||u==v&&w==x?
a[j]:'0'}).each{r(a[0..<i]+it+a[i+1..-1])}}else print a}
```

Or without the matcher (193 characters plus two newlines):

```
def r(a){int i=a.indexOf(48);if(i<0)print a else(('1'..'9')-(0..80).collect{j->
int q=j/9,r=i/9,u=q/3,v=r/3,w=j%9/3,x=i%9/3;q==r||i%9==j%9||u==v&&w==x?a[j]:'0'
}).each{r(a[0..<i]+it+a[i+1..-1])}}}
```

Also see [another version](#) for a more understandable (though much longer) algorithm - but it also does a lot more.

SwingBuilder with custom widgets and observer pattern

This page last changed on Oct 06, 2007 by [paulk_asert](#).

In this tutorial you will learn how to:

- use custom widgets with SwingBuilder,
- implement observer pattern (also known as subject-observer pattern) in Swing & Groovy,
- use action listeners with SwingBuilder,
- build simple currency converter 😊.

Swing introduced modified **MVC** pattern (for more details see <http://java.sun.com/products/jfc/tsc/articles/architecture/>). To update model I'll use **observer pattern** (if you're not familiar with it, see http://en.wikipedia.org/wiki/Observer_pattern) which is directly supported in Java by `Observable` class and `Observer` interface in `java.util` package.

For the example let's choose currency converter application from **Java Generics and Collections** book by *Maurice Naftalin* and *Philip Wadler* (<http://www.oreilly.com/catalog/javagenerics/>) from chapter 9.5. It will show explicitly the benefits from using dynamic language like Groovy over static typed Java with generic observer pattern introduced in the book. If you would like to see implementation of generic observer pattern you can download examples from the book website and have a look.

OK. Let's start with the model:

```
class Model extends Observable {
    static CURRENCY = ["USD", "EURO", "YEN"]

    private Map rates = new HashMap()
    private long value

    void initialize(initialRates) {
        (0..CURRENCY.size() - 1).each {
            setRate(CURRENCY[it], initialRates[it])
        }
    }

    // setting rate for currency
    void setRate(currency, f) {
        rates.put(currency, f);
        setChanged();
        notifyObservers(currency);
    }

    // setting new value for currency
    void setValue(currency, double newValue) {
        value = Math.round(newValue / rates[currency]);
        setChanged();
        notifyObservers(null);
    }

    // getter for value for particular currency
    def getValue(currency) {
        value * rates[currency]
    }
}
```

The converter model allows conversions over three different currencies. As you can see it extends `Observable` class to provide `Model` class observable behaviour (for more details see [java.util.Observable](#)).

Now let's create two custom widgets for displaying rate and value.

```
class RateView extends JTextField implements Observer {
    private Model model;
    private currency;

    public void setModel(Model model) {
```

```

this.model?.removeObserver(this)
this.model = model
model.addObserver(this)
}

public void update(Observable o, Object currency) {
if (this.currency == currency)
text = String.format("%15.2f", model.rates[currency])
}
}

class ValueView extends JTextField implements Observer {
private Model model
private currency

public void setModel(Model model) {
this.model?.removeObserver(this)
this.model = model
model.addObserver(this)
}

public void update(Observable o, Object currency) {
if (currency == null || this.currency == currency)
text = String.format("%15.2f", model.getValue(this.currency));
}
}

```

These classes extends `JTextField` to hold model and currency which is representing. They also implement `Observer` interface to be noticed when the model is changed. As you can see in `update` method there are not class casts required although it receives `Object`, because as dynamic nature of Groovy. Also in `setModel` method safe dereferencing is shown to protect from throwing `NullPointerException` when initially model is `null`.

Now let's put it all together.

```

swing = new SwingBuilder()
model = new Model()

frame = swing.frame(title: "Groovy SwingBuilder MVC Demo", layout: new GridLayout(4, 3), size:
[300, 150],
defaultCloseOperation: WindowConstants.EXIT_ON_CLOSE) {

label("currency")
label("rate")
label("value")

for (c in Model.CURRENCY) {
label(c)
widget(new RateView(), model: model, currency: c,
action: swing.action(closure: { event ->
event.source.model.setRate(event.source.currency, event.source.text.toDouble());
}))
widget(new ValueView(), model: model, currency: c, action: swing.action(closure: {event ->
event.source.model.setValue(event.source.currency, event.source.text.toDouble());
}))
}
}

frame.show()
model.initialize([1.0, 0.83, 0.56]);

```

Frame is constructed by using `swing.frame()`. To frame there are provided `title`, `layout`, `defaultCloseOperation`, `size` properties. You can think of it like creating a new instance of `JFrame` and invoking methods `setTitle()`, `setLayout()`, `setDefaultCloseOperation()`, `setSize()`. Then 12 components are added to frame:

- JLabel components using label("label's text"),
- RateView components using widget() builder method and setting model, currency attributes,
- ValueView components in the same way like RateView.

When new rate or value is entered all action listeners of that component are noticed with actionPerformed() method ([java.awt.ActionListener](#)). To construct classes which implements ActionListener interface SwingBuilder provides **action()** builder method. One of this method's attributes is closure when we are able to provide our closure with application logic. The closure argument has ActionEvent type.

Download the source code of the example: [SwingBuilderObserver.groovy](#)

Tomcat tools

This page last changed on Dec 21, 2007 by [thebugslayer](#).

You ever want to run multiple instance of tomcats with the same install base, but tired of copy and setup server.xml file? Attached are couple Groovy scripts that create new server instances, and a tool to quickly setup a new Groovlet webapp.

NewTomcatInstance.groovy

Assume you have installed Tomcat6 or Tomcat5 in /opt/tomcat directory.

```
ztoy:~/s zemian$ ./NewTomcatInstance.groovy /opt/tomcat mytomcat
Create new instance dir /opt/tomcat/instances/mytomcat
Create server.xml file with httpPort 8081, httpPort 8081
Create tomcat-user.xml file with manager role user.
Create catalina-mytomcat.sh file
Create ROOT webapp
Create ROOT webapp web.xml
Create ROOT webapp index.jsp
Done.
To Start Server: /opt/tomcat/bin/catalina-mytomcat.sh start
To View Browser: http://127.0.0.1:8081
```

Run it again to create another instance with mytomcat2, and it should configure to port 8082 and so on...

Each new server instance will contains a ROOT webapp that list all other webapps for quick links.

Also, the server instance is configured with Tomcat manager webapp enabled with a user: admin. If you are in this stage, you ought to know where to look for your password. 😊



Security

As stated in Tomcat documentation, enabling Tomcat manager is considered a potential security hole as it enable authenticated users to have total control over your webapps. It's enabled in this script for the sake of easy setup and quick management.

To remove a previous installed instance

```
ztoy:~/s zemian$ ./delete_tomcat_instance.groovy /opt/tomcat mytomcat
```

NewWebapp.groovy

This script will create a new webapp directory structure with all the Groovlet setup ready.

```
ztoy:~/s zemian$ ./NewWebapp.groovy /opt/tomcat/instances/mytomcat/webapps mywebapp
Create webapp
Copy groovy jar to lib
[copy] Copying 1 file to /opt/tomcat/instances/mytomcat/webapps/mywebapp/WEB-INF/lib
Create webapp web.xml
Create webapp index.gsp
Create webapp mysqlreport.groovy
Create webapp mysqlreport.gsp
Done.
```

Start your server and you have a webapp ready to go!

The mysqlreport.groovy is a updated version of Andrew Glover's

<http://www.ibm.com/developerworks/java/library/j-pg03155/>

And you will need mysql jdbc driver jar copy into mywebapp/WEB-INF/lib to work.

Unsign Jar Files (Recursively)

This page last changed on Feb 14, 2007 by [moatas](#).

```
ant = new AntBuilder();
tmpDir = "tmpDir"

new File(args[0]).eachFileRecurse({file->
  if(file.name.endsWith(".jar")) {
    ant.sequential {
      mkdir(dir:tmpDir)
      echo "Unsigning file: $file"
      unjar(src:file, dest:tmpDir)
      delete {
        fileset(dir:tmpDir, includes:"META-INF/*.DSA,META-INF/*.SF,META-INF/*.RSA")
      }
      jar(destFile:file,baseDir:tmpDir)
      delete(dir:tmpDir)
    }
  }
})
```

Using JGoodies Animation with Groovy

This page last changed on Jun 20, 2007 by [paulk_asert](#).

```
// require(url:'jgoodies.com', jar:'animation', version:'1.2.0')
// require(url:'jgoodies.com', jar:'forms', version:'1.1.0')

// Based on the jgoodies animation tutorial class:
//     com.jgoodies.animation.tutorial.intro.BasicTextLabelIntro

import static java.awt.Color.*
import java.awt.Font
import javax.swing.*

import static com.jgoodies.animation.Animations.*
import static com.jgoodies.animation.animations.BasicTextAnimation.defaultFade as fadeText
import static com.jgoodies.animation.animations.BasicTextAnimations.defaultFade as fadeTexts
import com.jgoodies.animation.*
import com.jgoodies.animation.components.BasicTextLabel
import com.jgoodies.forms.builder.PanelBuilder
import com.jgoodies.forms.layout.CellConstraints
import com.jgoodies.forms.layout.FormLayout

class AnimateAction extends AbstractAction {
    def animation
    void actionPerformed(java.awt.event.ActionEvent e) {
        animation.addAnimationListener([
            animationStarted: { ae -> enabled = false },
            animationStopped: { ae -> enabled = true }
        ] as AnimationListener)
        new Animator(animation, 30 /*fps*/).start()
    }
}

def buildPanel(labels) {
    def layout = new FormLayout('fill:pref:grow', 'fill:pref:grow, p, p')
    def builder = new PanelBuilder(layout)
    def cc = new CellConstraints()
    builder.add(buildPreviewPanel(labels), cc.xy(1, 1))
    builder.addSeparator(' ', cc.xy(1, 2))
    builder.add(buildToolsPanel(labels), cc.xy(1, 3))
    return builder.panel
}

def buildPreviewPanel(labels) {
    def layout = new FormLayout('fill:200dlu:grow', 'fill:100dlu:grow')
    def panel = new JPanel(layout)
    def cc = new CellConstraints()
    panel.background = WHITE
    panel.add(labels[0], cc.xy(1, 1))
    panel.add(labels[1], cc.xy(1, 1))
    return panel
}

def buildToolsPanel(labels) {
    def layout = new FormLayout('right:pref:grow', 'pref')
    def builder = new PanelBuilder(layout)
    builder.setDefaultDialogBorder()
    def cc = new CellConstraints()
    def action = new AnimateAction(animation:createAnimation(labels))
    action.putValue('Name', 'Animate')
    builder.add(new JButton(action), cc.xy(1, 1))
    return builder.panel
}

def createAnimation(labels) {
```

```

Animation[] animations = [
    pause(1000),
    fadeText(labels[0], 2500, 'Welcome To', DARK_GRAY),
    pause(1000),
    fadeText(labels[0], 3000, 'JGoodies Animation', DARK_GRAY),
    pause(1000),
    fadeTexts(labels[0], labels[1], 2000, -100,
        'An open source framework|for time-based|' +
        'real-time animations|in Java and Groovy.',
        DARK_GRAY),
    pause(1000),
    fadeTexts(labels[0], labels[1], 3000, 500, 'Main Features:', DARK_GRAY),
    pause(1000),
    fadeTexts(labels[0], labels[1], 1750, 0,
        'Seamless|flexible|and powerful integration|' +
        'with Java and Groovy.|Small library size.',
        DARK_GRAY),
    pause(1500)
]
sequential(animations)
}

def buildLabel(font) {
    def label = new BasicTextLabel(' ')
    label.font = font
    label.opaque = false
    return label
}

def centerOnScreen(component) {
    def paneSize = component.size
    def screenSize = component.toolkit.screenSize
    int x = (screenSize.width - paneSize.width) / 2
    int y = (screenSize.height - paneSize.height) * 0.45
    component.setLocation(x, y)
}

def font = new Font('Tahoma', Font.BOLD, 18)
def label1 = buildLabel(font)
def label2 = buildLabel(font)
def frame = new JFrame()
frame.title = 'Groovy/JGoodies Animation Demo'
frame.defaultCloseOperation = WindowConstants.EXIT_ON_CLOSE
def panel = buildPanel([label1, label2])
frame.contentPane.add(panel)
frame.pack()
centerOnScreen(frame)
frame.visible = true

```

Using JScience with Groovy

This page last changed on Jan 15, 2008 by [phk](#).

[JScience](#) is a comprehensive Java library for the scientific community encompassing various areas of science including math, physics, sociology, biology, astronomy, economics.

```
/*
// require(name:'JScience', version:'3.2', url:'http://jscience.org/jscience-vm14.jar')
import org.jscience.mathematics.numbers.Complex
import static org.jscience.mathematics.numbers.Complex.I
import static org.jscience.mathematics.numbers.Complex.valueOf as c
import org.jscience.mathematics.functions.Polynomial
import static org.jscience.mathematics.functions.Polynomial.valueOf as p
import org.jscience.mathematics.functions.Variable
*/

// require(name:'JScience', version:'4.3.1', url:'http://jscience.org/jscience-4.3.1-bin.zip')
import org.jscience.mathematics.number.Complex
import static org.jscience.mathematics.number.Complex.I
import static org.jscience.mathematics.number.Complex.valueOf as c
import org.jscience.mathematics.function.Polynomial
import static org.jscience.mathematics.function.Polynomial.valueOf as p
import org.jscience.mathematics.function.Variable

// Defines two local variables (x, y).
def varX = new Variable.Local<Complex>("x")
def varY = new Variable.Local<Complex>("y")

use (JScienceCategory) {
def ONE = Complex.ONE
def TWO = c(2, 0)
// f(x) = ix2 + 2x + 1
def x = p(ONE, varX)
def fx = I * x ** 2 + TWO * x + ONE
println fx
println fx ** 2
println fx.differentiate(varX)
println fx.integrate(varY)
println fx.compose(fx)

// Calculates expression.
varX.set(c(2, 3))
println fx.evaluate()
}

class JScienceCategory {
static power(Polynomial p, int n) {
p.pow(n)
}
static multiply(Complex c, Polynomial p) {
p.times(c)
}
static multiply(Polynomial p, Complex c) {
p.times(c)
}
}
```

Running this script yields:

```
[0.0 + 1.0i]x2 + [2.0 + 0.0i]x + [1.0 + 0.0i]
[-1.0 + 0.0i]x4 + [0.0 + 4.0i]x3 + [4.0 + 2.0i]x2 + [4.0 + 0.0i]x + [1.0 + 0.0i]
[0.0 + 2.0i]x + [2.0 + 0.0i]
[0.0 + 1.0i]x2y + [2.0 + 0.0i]xy + [1.0 + 0.0i]y
[0.0 - 1.0i]x4 + [-4.0 + 0.0i]x3 + [-2.0 + 6.0i]x2 + [4.0 + 4.0i]x + [3.0 + 1.0i]
-7.0 + 1.0i
```

Using MarkupBuilder for Agile XML creation

This page last changed on Jan 16, 2008 by [paulk_asert](#).

Two principles of Agile development are *DRY* (don't repeat yourself) and *merciless refactoring*. Thanks to excellent IDE support it isn't too hard to apply these principles to coding Java and Groovy but it's a bit harder with XML.

The good news is that Groovy's Builder notation can help. Whether you are trying to refactor your Ant build file(s) or manage a family of related XML files (e.g. XML request and response files for testing Web Services) you will find that you can make great advances in managing your XML files using builder patterns.

	<p>Scenario: Consider we have a program to track the sales of</p> <p>copies of GINA 😊. Books leave a warehouse in trucks. Trucks contain big boxes which are sent off to various countries. The big boxes contain smaller boxes which travel to different states and cities around the world. These boxes may also contain smaller boxes as required. Eventually some of the boxes contain just books. Either GINA or some potential upcoming Groovy titles. Suppose the delivery system produces XML files containing the items in each truck. We are responsible for writing the system which does some fancy reporting.</p>	
--	---	--

If we are a vigilant tester, we will have a family of test files which allow us to test the many possible kinds of XML files we need to deal with. Instead of having to manage a directory full of files which would be hard to maintain if the delivery system changed, we decide to use Groovy to generate the XML files we need. Here is our first attempt:

```
import groovy.xml.MarkupBuilder

def writer = new StringWriter()
def xml = new MarkupBuilder(writer)
xml.truck(id:'ABC123') {
  box(country:'Australia') {
    box(country:'Australia', state:'QLD') {
      book(title:'Groovy in Action', author:'Dierk König et al')
      book(title:'Groovy in Action', author:'Dierk König et al')
      book(title:'Groovy for VBA Macro writers')
    }
    box(country:'Australia', state:'NSW') {
      box(country:'Australia', state:'NSW', city:'Sydney') {
        book(title:'Groovy in Action', author:'Dierk König et al')
        book(title:'Groovy for COBOL Programmers')
      }
      box(country:'Australia', state:'NSW', suburb:'Albury') {
        book(title:'Groovy in Action', author:'Dierk König et al')
        book(title:'Groovy for Fortran Programmers')
      }
    }
  }
  box(country:'USA') {
    box(country:'USA', state:'CA') {
      book(title:'Groovy in Action', author:'Dierk König et al')
```

```

book(title:'Groovy for Ruby programmers')
}
}
box(country:'Germany') {
box(country:'Germany', city:'Berlin') {
book(title:'Groovy in Action', author:'Dierk König et al')
book(title:'Groovy for PHP Programmers')
}
}
box(country:'UK') {
box(country:'UK', city:'London') {
book(title:'Groovy in Action', author:'Dierk König et al')
book(title:'Groovy for Haskell Programmers')
}
}
}

println writer.toString()

```

There is quite a lot of replication in this file. Lets refactor out two helper methods `standardBook1` and `standardBook2` to remove some of the duplication. We now have something like this:

```

import groovy.xml.MarkupBuilder

// standard book
def standardBook1(builder) { builder.book(title:'Groovy in Action', author:'Dierk König et al') }
// other standard books
def standardBook2(builder, audience) { builder.book(title:"Groovy for ${audience}") }
def writer = new StringWriter()
def xml = new MarkupBuilder(writer)
xml.truck(id:'ABC123') {
box(country:'Australia') {
box(country:'Australia', state:'QLD') {
standardBook1(xml)
standardBook1(xml)
standardBook2(xml, 'VBA Macro writers')
}
box(country:'Australia', state:'NSW') {
box(country:'Australia', state:'NSW', city:'Sydney') {
standardBook1(xml)
standardBook2(xml, 'COBOL Programmers')
}
box(country:'Australia', state:'NSW', suburb:'Albury') {
standardBook1(xml)
standardBook2(xml, 'Fortran Programmers')
}
}
}
box(country:'USA') {
box(country:'USA', state:'CA') {
standardBook1(xml)
standardBook2(xml, 'Ruby Programmers')
}
}
box(country:'Germany') {
box(country:'Germany', city:'Berlin') {
standardBook1(xml)
standardBook2(xml, 'PHP Programmers')
}
}
box(country:'UK') {
box(country:'UK', city:'London') {
standardBook1(xml)
standardBook2(xml, 'Haskell Programmers')
}
}
}

```



```
}
```

```
println writer.toString()
```

Next, let's refactor out a few more methods to end up with the following:

```
import groovy.xml.MarkupBuilder

// define standard book and version allowing multiple copies
def standardBook1(builder) { builder.book(title:'Groovy in Action', author:'Dierk König et al') }
def standardBook1(builder, copies) { (0..<copies).each{ standardBook1(builder) } }
// another standard book
def standardBook2(builder, audience) { builder.book(title:"Groovy for ${audience}") }
// define standard box
def standardBox1(builder, args) {
def other = args.findAll{it.key != 'audience'}
builder.box(other) { standardBook1(builder); standardBook2(builder, args['audience']) }
}
// define standard country box
def standardBox2(builder, args) {
builder.box(country:args['country']) {
if (args.containsKey('language')) {
args.put('audience', args['language'] + ' programmers')
args.remove('language')
}
standardBox1(builder, args)
} }

def writer = new StringWriter()
def xml = new MarkupBuilder(writer)
xml.truck(id:'ABC123') {
box(country:'Australia') {
box(country:'Australia', state:'QLD') {
standardBook1(xml, 2)
standardBook2(xml, 'VBA Macro writers')
}
box(country:'Australia', state:'NSW') {
[Sydney:'COBOL', Albury:'Fortran'].each{ city, language ->
standardBox1(xml, [country:'Australia', state:'NSW',
city:"${city}", audience:"${language} Programmers"])
} } }
standardBox2(xml, [country:'USA', state:'CA', language:'Ruby'])
standardBox2(xml, [country:'Germany', city:'Berlin', language:'PHP'])
standardBox2(xml, [country:'UK', city:'London', language:'Haskel'])
}

println writer.toString()
```

This is better. If the format of our XML changes, we will minimise the changes required in our builder code. Similarly, if we need to produce multiple XML files, we can add some for loops, closures or if statements to generate all the files from one or a small number of source files.

We could extract out some of our code into a helper method and the code would become:

```
import groovy.xml.MarkupBuilder

def writer = new StringWriter()
def xml = new MarkupBuilder(writer)
def standard = new StandardBookDefinitions(xml)
xml.truck(id:'ABC123') {
box(country:'Australia') {
box(country:'Australia', state:'QLD') {
standard.book1(2)
standard.book2('VBA Macro writers')
}
box(country:'Australia', state:'NSW') {
```

```

[Sydney:'COBOL', Albury:'Fortran'].each{ city, language ->
standard.box1(country:'Australia', state:'NSW',
city:"${city}", audience:"${language} Programmers")
} }
standard.box2(country:'USA', state:'CA', language:'Ruby')
standard.box2(country:'Germany', city:'Berlin', language:'PHP')
standard.box2(country:'UK', city:'London', language:'Haskel')
}

println writer.toString()

```

So far we have just produced the one XML file. It would make sense to use similar techniques to produce all the XML files we need. We can take this in several directions at this point including using GStrings, using database contents to help generate the content or making use of templates.

We won't look at any of these, instead we will just augment the previous example just a little more. First we will slightly expand our helper class. Here is the result:

StandardBookDefinitions.groovy

```

import groovy.xml.MarkupBuilder

class StandardBookDefinitions {
private def builder
StandardBookDefinitions(builder) {
this.builder = builder
}
def removeKey(args, key) { return args.findAll{it.key != key} }
// define standard book and version allowing multiple copies
def book1() { builder.book(title:'Groovy in Action', author:'Dierk König et al') }
def book1(copies) { (0..<copies).each{ book1() } }
// another standard book
def book2(audience) { builder.book(title:"Groovy for ${audience}") }
// define standard box
def box1(args) {
def other = removeKey(args, 'audience')
builder.box(other) { book1(); book2(args['audience']) }
}
// define standard country box
def box2(args) {
builder.box(country:args['country']) {
if (args.containsKey('language')) {
args.put('audience', args['language'] + ' programmers')
args.remove('language')
}
}
box1(args)
} }
// define deep box
def box3(args) {
def depth = args['depth']
def other = removeKey(args, 'depth')
if (depth > 1) {
builder.box(other) {
other.put('depth', depth - 1)
box3(other)
}
} else {
box2(other)
} }
// define deep box
def box4(args) {
builder.box(country:'South Africa'){
(0..<args['number']).each{ book1() }
}
}
}
}

```

And now we will use this helper class to generate a family of related XML files. For illustrative purposes, we will just print out the generated files rather than actually store the files.

```
import groovy.xml.MarkupBuilder

def writer = new StringWriter()
xml = new MarkupBuilder(writer)
standard = new StandardBookDefinitions(xml)
def shortCountry = 'UK'
def longCountry = 'The United Kingdom of Great Britain and Northern Ireland'
def shortState = 'CA'
def longState = 'The State of Rhode Island and Providence Plantations'
def countryForState = 'USA'

def generateWorldOrEuropeXml(world) {
xml.truck(id:'ABC123') {
if (world) {
box(country:'Australia') {
box(country:'Australia', state:'QLD') {
standard.book1(2)
standard.book2('VBA Macro writers')
}
}
box(country:'Australia', state:'NSW') {
[Sydney:'COBOL', Albury:'Fortran'].each{ city, language ->
standard.box1(country:'Australia', state:'NSW',
city:"${city}", audience:"${language} Programmers")
} }
standard.box2(country:'USA', state:'CA', language:'Ruby')
}
standard.box2(country:'Germany', city:'Berlin', language:'PHP')
standard.box2(country:'UK', city:'London', language:'Haskel')
}
}

def generateSpecialSizeXml(depth, number) {
xml.truck(id:'DEF123') {
standard.box3(country:'UK', city:'London', language:'Haskel', depth:depth)
standard.box4(country:'UK', city:'London', language:'Haskel', number:number)
box(country:'UK') {} // empty box
}
}

def generateSpecialNamesXml(country, state) {
xml.truck(id:'GHI123') {
if (state) {
box(country:country, state:state){ standard.book1() }
} else {
box(country:country){ standard.book1() }
}
}
}

generateWorldOrEuropeXml(true)
generateWorldOrEuropeXml(false)
generateSpecialSizeXml(10, 10)
generateSpecialNamesXml(shortCountry, '')
generateSpecialNamesXml(longCountry, '')
generateSpecialNamesXml(countryForState, shortState)
generateSpecialNamesXml(countryForState, longState)
println writer.toString()
```

This will be much more maintainable over time than a directory full of hand-crafted XML files.

Here is what will be produced:

```
<truck id='ABC123'>
```

```

<box country='Australia'>
<box state='QLD' country='Australia'>
<book title='Groovy in Action' author='Dierk König et al' />
<book title='Groovy in Action' author='Dierk König et al' />
<book title='Groovy for VBA Macro writers' />
</box>
<box state='NSW' country='Australia'>
<box city='Albury' state='NSW' country='Australia'>
<book title='Groovy in Action' author='Dierk König et al' />
<book title='Groovy for Fortran Programmers' />
</box>
<box city='Sydney' state='NSW' country='Australia'>
<book title='Groovy in Action' author='Dierk König et al' />
<book title='Groovy for COBOL Programmers' />
</box>
</box>
</box>
<box country='USA'>
<box state='CA' country='USA'>
<book title='Groovy in Action' author='Dierk König et al' />
<book title='Groovy for Ruby programmers' />
</box>
</box>
<box country='Germany'>
<box city='Berlin' country='Germany'>
<book title='Groovy in Action' author='Dierk König et al' />
<book title='Groovy for PHP programmers' />
</box>
</box>
<box country='UK'>
<box city='London' country='UK'>
<book title='Groovy in Action' author='Dierk König et al' />
<book title='Groovy for Haskell programmers' />
</box>
</box>
</truck>
<truck id='ABC123'>
<box country='Germany'>
<box city='Berlin' country='Germany'>
<book title='Groovy in Action' author='Dierk König et al' />
<book title='Groovy for PHP programmers' />
</box>
</box>
<box country='UK'>
<box city='London' country='UK'>
<book title='Groovy in Action' author='Dierk König et al' />
<book title='Groovy for Haskell programmers' />
</box>
</box>
</truck>
<truck id='DEF123'>
<box language='Haskell' city='London' country='UK'>
<box language='Haskell' city='London' country='UK'>
<box language='Haskell' city='London' country='UK'>
<box language='Haskell' city='London' country='UK'>
<box language='Haskell' city='London' country='UK'>
<box language='Haskell' city='London' country='UK'>
<box language='Haskell' city='London' country='UK'>
<box language='Haskell' city='London' country='UK'>
<box language='Haskell' city='London' country='UK'>
<box language='Haskell' city='London' country='UK'>
<box language='Haskell' city='London' country='UK'>
<box country='UK'>
<box city='London' country='UK'>
<book title='Groovy in Action' author='Dierk König et al' />
<book title='Groovy for Haskell programmers' />
</box>
</box>

```

```
</box>
</box>
</box>
</box>
</box>
</box>
</box>
</box>
</box>
<box country='South Africa'>
<book title='Groovy in Action' author='Dierk König et al' />
<book title='Groovy in Action' author='Dierk König et al' />
<book title='Groovy in Action' author='Dierk König et al' />
<book title='Groovy in Action' author='Dierk König et al' />
<book title='Groovy in Action' author='Dierk König et al' />
<book title='Groovy in Action' author='Dierk König et al' />
<book title='Groovy in Action' author='Dierk König et al' />
<book title='Groovy in Action' author='Dierk König et al' />
<book title='Groovy in Action' author='Dierk König et al' />
</box>
<box country='UK' />
</truck>
<truck id='GHI123'>
<box country='UK'>
<book title='Groovy in Action' author='Dierk König et al' />
</box>
</truck>
<truck id='GHI123'>
<box country='The United Kingdom of Great Britain and Northern Ireland'>
<book title='Groovy in Action' author='Dierk König et al' />
</box>
</truck>
<truck id='GHI123'>
<box state='CA' country='USA'>
<book title='Groovy in Action' author='Dierk König et al' />
</box>
</truck>
<truck id='GHI123'>
<box state='The State of Rhode Island and Providence Plantations' country='USA'>
<book title='Groovy in Action' author='Dierk König et al' />
</box>
</truck>
```

Using the Delegating Meta Class

This page last changed on Apr 11, 2008 by [mcspanky](#).

This is an example of how to replace a MetaClass to adjust the default behavior. Each groovy object has a metaClass that is used to manage the dynamic nature of the language. This class intercepts calls to groovy objects to ensure that the appropriate grooviness can be added. For example, when an object is constructed, the MetaClass's `invokeConstructor()` is called. One feature of the `invokeConstructor` allows us to create groovy objects using a map argument to set the properties of the object (`new X([prop1: value1, prop2: value2]))`).

These solutions perform complete replacements, where as a more scoped solution can be found at [Using the Proxy Meta Class](#).

InvokeHelper Solution

This technique installs the meta class at runtime using the `InvokerHelper` to gain access to the registry which allows us to change the meta class instance that is in use. The behaviour for objects created before the change depends on whether they are Java or Groovy objects. Groovy objects "cache" their metaClass, so once they're created, changing the registry has no effect. However, Java objects don't have a cache, so accesses to them always start with a trip to the registry, meaning any registry changes affect existing and new instances alike.

This sample code overrides the `invokeMethod` method to augment the behavior but there are other options that you can choose from like `set` and `getAttribute`, `invokeStaticMethod` and `invokeConstructor`. The complete list can be found in the Groovy's source release in "`src/main/groovy/lang/DelegatingMetaClass.java`".

```
import org.codehaus.groovy.runtime.InvokerHelper

class DelegatingMetaClassInvokeHelperTest extends GroovyTestCase
{
void testReplaceMetaClass()
{
/*
* Constructing first instance before meta class replacment
* is made.
*/
def firstInstance = "first"
assertEquals "first", firstInstance.toString()

def myMetaClass = new MyDelegatingMetaClass(String.class)
InvokerHelper.metaRegistry.setMetaClass(String.class, myMetaClass)

/*
* Constructing second instance after meta class replacment
* is made.
*/
def secondInstance = "second"

/*
* Since we are replacing a meta class at the class level
* we are changing the behavior of the first and second
* instance of the string.
*/
assertEquals "changed first", firstInstance.toString()
assertEquals "changed second", secondInstance.toString()
}
}

class MyDelegatingMetaClass extends groovy.lang.DelegatingMetaClass
{
MyDelegatingMetaClass(final Class aclass)
{
super(aclass);
initialize()
}
}
```

```

public Object invokeMethod(Object a_object, String a_methodName, Object[] a_arguments)
{
return "changed ${super.invokeMethod(a_object, a_methodName, a_arguments)}"
}
}

```

Package Name Convention Solution

This second solution offers a more consistent augmentation of existing classes. There are no risks of unpredictable results from methods. The idea is that any package.class can have a custom meta class loaded at startup time by placing it into a well known package with a well known name.

```
groovy.runtime.metaclass.[YOURPACKAGE].[YOURCLASS]MetaClass
```

So your class Foo in package "bar" could have a custom meta class FooMetaClass in package "groovy.runtime.metaclass.bar".

The following example shows how we can change the behavior of the String class. Firstly the custom meta class, similar to the implementation above except that it needs a MetaClassRegistry argument in its constructor.

```

package groovy.runtime.metaclass.java.lang

class StringMetaClass extends groovy.lang.DelegatingMetaClass
{
StringMetaClass(MetaClass delegate)
{
super(delegate);
}

public Object invokeMethod(Object a_object, String a_methodName, Object[] a_arguments)
{
return "changed ${super.invokeMethod(a_object, a_methodName, a_arguments)}"
}
}

```

The actual class that uses the enhanced features is now very simple. Notice that there are no extra imports or any work with the meta class. The mere package and name of the class tells the groovy runtime to use the custom meta class.

```

class DelegatingMetaClassPackageImpliedTest extends GroovyTestCase
{
void testReplaceMetaClass()
{
assertEquals "changed hello world", "hello world".toString()
}
}

```

Precedence

So what would happen if you used both techniques. Assume that the package convention class exists in your class path and you create and set another meta class. The answer is that the last setMetaClass that you did applies to the usages of all instance of the effected type.

Using the Eclipse Modeling Framework (EMF)

This page last changed on Jun 24, 2007 by joern@dinkla.net.

Access to models generated with the [Eclipse Modeling Framework](#) is easy in Groovy with the help of Groovy Beans and GPath.

As an example we use the [EMF tutorial](#). This model contains three classes Book, Writer and Library and an enumeration BookCategory. From this model EMF generates Java code. There are two special classes: a package class and a factory class. We need the package class for reading the model. We have to instantiate it and load a file with data as following.

```
LibraryPackage.eINSTANCE
def resource = new XMIResourceImpl(URI.createURI('hardboiled.library'))
resource.load(null)
Library library = (Library) resource.contents\[0\]           // get the root element
```

Now we are able to query the model using standard Groovy. For example

```
for ( book in library.books ) {
println book.author.name + ', ' + book.title + ', ' + book.category + ', ' + book.pages
}
```

prints out all books. We can print out all the books with less than 240 pages with the following statement.

```
println library.books.grep { it.pages < 240 }.title.join(", ")
```

All the objects in an EMF model are constructed with methods from a factory (LibraryFactory in this example). The [Groovy EMF Builder](#) provides an interface for constructing models and model elements. It takes an EMF factory as an argument. In the following snippet three objects are created in the model: a Library, a Writer and a Book.

```
def builder = new EMFBuilder(LibraryFactory)
def writer
def library = builder.Library( name : 'Hardboiled Library') {
writers {
writer = Writer( name : 'Raymond Chandler')
}
books {
Book ( title: 'The Big Sleep', pages: 234, category: BookCategory.MYSTERY_LITERAL, author: writer)
}
}
```

The braces indicate the containment relationships writers and books of the class Library. See the homepage of the [Groovy EMF Builder](#) for further details.

Using the Eclipse UML2 Framework

This page last changed on Nov 28, 2007 by joern@dinkla.net.

The [Eclipse UML2](#) project provides an implementation of the [Unified Modeling Language \(UML\) 2.1](#) metamodel in Java. The fact that the underlying technology is the [Eclipse Modeling Framework \(EMF\)](#) makes it possible to use the [EMFBuilder](#) with the UML2 metamodel.

The [introductory article](#) by Ken Hussey explains how to create UML2 models with the Eclipse editor and how to create them programmatically with Java code. Here we will use Groovy and the [EMFBuilder](#).

We use the UMLFactory for the EMFBuilder.

```
def builder = new EMFBuilder(UMLFactory)
```

We create a model as the root node and then we create two primitive types and store them in Groovy variables because we have to reference them later on.

```
def epo2Model = builder.Model(name: 'epo2') {
  packagedElement {
    def intPrimitiveType = PrimitiveType(name: 'int')
    def stringPrimitiveType = PrimitiveType(name: 'String')
  }
}
```

We define an enumeration OrderStatus with three literals.

```
def orderStatusEnumeration = Enumeration(name: 'OrderStatus') {
  ownedLiteral {
    EnumerationLiteral(name: 'Pending')
    EnumerationLiteral(name: 'Back Order')
    EnumerationLiteral(name: 'Complete')
  }
}
```

The following code snippet shows the definition of the classes Address and USAddress. All the attributes are defined as a Property. The primitive types stringPrimitiveType and intPrimitiveType defined above are used. The class USAddress is a subclass of the abstract class Address. This is expressed with the Generalization object.

```
def addressClass = Class(name: 'Address' ,isAbstract: true) {
  ownedAttribute {
    Property(name: 'name', type: stringPrimitiveType, lower: 0, upper: 1)
    Property(name: 'country', type: stringPrimitiveType, lower: 0, upper: 1)
  }
}
def usAddressClass = Class(name: 'USAddress') {
  generalization {
    Generalization(general: addressClass)
  }
  ownedAttribute {
    Property(name: 'street', type: stringPrimitiveType, lower: 0, upper: 1)
    Property(name: 'city', type: stringPrimitiveType, lower: 0, upper: 1)
    Property(name: 'state', type: stringPrimitiveType, lower: 0, upper: 1)
    Property(name: 'zip', type: intPrimitiveType, lower: 0, upper: 1)
  }
}
```

Compare this code to the original code in the article! The code is much more concise and is a direct representation of the UML2 diagram. No auxiliary methods are needed.

See the homepage of the [UML2 Builder](#) for further details.

Using the Proxy Meta Class

This page last changed on Mar 17, 2007 by [gavingrover](#).

The [Using the Delegating Meta Class](#) page talks about techniques to change the behavior of existing classes by replacing the meta class in use. However, the Delegating Meta Class effects all loaded classes.

The Proxy Meta Class allows us to replace the meta class in use by a class but in a well defined scope. This technique would be more appropriate for temporary behavior replacements such as

This example shows how we can create a proxy meta class for the String class and intercept its method invocations.

```
import org.codehaus.groovy.runtime.InvokerHelper

class ProxyMetaClassTest extends GroovyTestCase
{
void testProxyMetaClass()
{
def proxy = ProxyMetaClass.getInstance(String.class);
proxy.interceptor = new MyInterceptor()

def text = "hello world"

assertEquals "hello world", text.toString()

proxy.use {
assertEquals "changed hello world", text.toString()
}

assertEquals "hello world", text.toString()
}
}

class MyInterceptor implements groovy.lang.Interceptor
{
Object beforeInvoke(Object a_object, String a_methodName, Object[] a_arguments)
{
}

boolean doInvoke()
{
return true
}

Object afterInvoke(Object a_object, String a_methodName, Object[] a_arguments, Object a_result)
{
return "changed ${a_result}"
}
}
```

For more detail on using the ProxyMetaClass, see <http://groovy.codehaus.org/Using+the+Proxy+Meta+Class+in+depth>.

Windows Look And Feel for groovyConsole

This page last changed on Apr 28, 2007 by [paulk_asert](#).

Add the following lines:

```
set JAVA_OPTS=%JAVA_OPTS% -Dswing.aatext=true
set JAVA_OPTS=%JAVA_OPTS% -Dswing.defaultlaf=com.sun.java.swing.plaf.windows.WindowsLookAndFeel
```

just after the line

```
if "%JAVA_OPTS%" == "" set JAVA_OPTS="-Xmx128m"
```

in `groovyConsole.bat`. The first line turns on text antialiasing and the second turns on the Windows Look And Feel. You can do the same in all the other `.bat` files as well. You may find the antialiasing doesn't improve the appearance of the fonts very much, in which case remove it.

WrappingGroovyScript

This page last changed on Feb 26, 2008 by berni_huber@a1.net.

Abstract

The script GroovyWrapper described on this page, creates a self-executable jar from a groovy script.

Description

The script GroovyWrapper allows you to distribute your groovy script as a standalone self-executable jar.

The generated jar contains the compiled groovy script, and the groovy embeddable jar. Moreover the jar's main-class is set to the compiled groovy script.

Havin this self-executable jar, you can start the groovy script, like `java -jar MyScriptAsJar.jar`

Groovy Wrapper Script

The Groovy Wrapper Script below is quite simple.

First it parses its command line arguments using groovy's CliBuilder.

- The argument `-m` defines the groovy script name, w/o `{}.class` suffix
- The optional argument `-d` allows defines the jar fileame, by default the jar filename is build as `{}groovy-script-name.jar`.
- The argument `-c` compile the groovy script in the GroovyWrapper. Use this argument if your groovy script is not compiled by some build process.

Next it checks the arguments, compiles the script if specified.

Then the environment variable `GROOVY_HOME` is looked up for calculating the file location of the groovy embeddable jar.

Finally GroovyWrapper builds the jar using AntBuilder.

The source of the GroovyWrapper script:

```
/*
 * Copyright 2002-2007 the original author or authors.
 *
 * Licensed under the Apache License, Version 2.0 (the "License");
 * you may not use this file except in compliance with the License.
 * You may obtain a copy of the License at
 *
 *     http://www.apache.org/licenses/LICENSE-2.0
 *
 * Unless required by applicable law or agreed to in writing, software
 * distributed under the License is distributed on an "AS IS" BASIS,
 * WITHOUT WARRANTIES OR CONDITIONS OF ANY KIND, either express or implied.
 * See the License for the specific language governing permissions and
 * limitations under the License.
 */

/**
 * Wrap a script and groovy jars to an executable jar
 */
def cli = new CliBuilder()
cli.h( longOpt: 'help', required: false, 'show usage information' )
cli.d( longOpt: 'destfile', argName: 'destfile', required: false, args: 1, 'jar destination
filename, defaults to {mainclass}.jar' )
cli.m( longOpt: 'mainclass', argName: 'mainclass', required: true, args: 1, 'fully qualified main
class, eg. HelloWorld' )
cli.c( longOpt: 'groovyc', required: false, 'Run groovyc' )
```

```

//-----
def opt = cli.parse(args)
if (!opt) { return }
if (opt.h) {
cli.usage();
return
}

def mainClass = opt.m
def scriptBase = mainClass.replace( '.', '/' )
def scriptFile = new File( scriptBase + '.groovy' )
if (!scriptFile.canRead()) {
println "Cannot read script file: '${scriptFile}'"
return
}
def destFile = scriptBase + '.jar'
if (opt.d) {
destFile = opt.d
}

//-----
def ant = new AntBuilder()

if (opt.c) {
ant.echo( "Compiling ${scriptFile}" )
org.codehaus.groovy.tools.FileSystemCompiler.main( [ scriptFile ] as String[] )
}

def GROOVY_HOME = new File( System.getenv('GROOVY_HOME') )
if (!GROOVY_HOME.canRead()) {
ant.echo( "Missing environment variable GROOVY_HOME: '${GROOVY_HOME}'" )
return
}

ant.jar( destfile: destFile, compress: true, index: true ) {
fileset( dir: '.', includes: scriptBase + '*.class' )

zipgroupfileset( dir: GROOVY_HOME, includes: 'embeddable/groovy-all-*.jar' )
zipgroupfileset( dir: GROOVY_HOME, includes: 'lib/commons*.jar' )
// add more jars here

manifest {
attribute( name: 'Main-Class', value: mainClass )
}
}

ant.echo( "Run script using: \'java -jar ${destFile} ...\'" )

```

Example

An example for using GroovyWrapper:

Say you have groovy script `HelloWorld.groovy`, use `GroovyWrapper` for building `HelloWorld.jar`, as follows:

```
$ groovy GroovyWrapper -c -m HelloWorld
```

`GroovyWrapper` will compile the script `HelloWorld.groovy` to `HelloWorld.class`, and creates a self-executable jar `HelloWorld.jar`.

Now you can use the `HelloWorld.jar` for launching the `HelloWorld` script, simply by running:

```
$ java -jar HelloWorld.jar
```

Writing to a Blob

This page last changed on May 18, 2007 by [sberka](#).

Writing to Blob!

Note: tested with Oracle DB 9.x and a thin driver 9.x !

```
import groovy.sql.Sql

println "---- A working test of writing and then reading a blob into an Oracle DB ----"
sql = Sql.newInstance("jdbc:oracle:thin:@pignut:1521:TESTBNDY", "userName",
"paSSword", "oracle.jdbc.OracleDriver")
sql.execute(
"INSERT INTO MEDIA VALUES (SEQ_MEDIAID.NextVal, empty_blob());"

sql.connection.autoCommit = false

try {
row = sql.firstRow("select SEQ_MEDIAID.CurrVal from Dual")
mediaID = row[0]

row = sql.firstRow("select binarydata from media where mediaid = ? for update",[mediaID])

my_blob = (oracle.sql.BLOB)row[0]
if( my_blob == null ) println "my_blob is null!"

// write the array of binary data to a BLOB
outstream = my_blob.getBinaryOutputStream();

// read data into a byte array
data = [0, 1, 2, 3, 4, 5, 6, 7, 8, 9] as byte[];
outstream.write(data);
outstream.close()

sql.commit()
} catch (Exception e) {
println "Failed: $e"
sql.rollback()
} finally {
sql.connection.close()
}
```

Uses a table:

```
CREATE TABLE MEDIA
(
MEDIAID NUMBER(22) NOT NULL,
BINARYDATA BLOB NOT NULL
);

CREATE SEQUENCE SEQ_MEDIAID
INCREMENT BY 1
START WITH 100
ORDER;
```

. Copying a file to Blob!

```
...
// write the array of binary data to a BLOB
outstream = my_blob.getBinaryOutputStream();

def fis= new FileInputStream('c:\\Jornada\\auxil\\010306_115332.jpg')
```

```
println "File size= ${fis.available()}"
byte[] data = new byte[fis.available()]
fis.read(data)
fis.close()

outstream.write(data);
outstream.close()

sql.commit()
...
```

Yaml and Groovy

This page last changed on Jun 19, 2007 by [paulk_asert](#).

[Yaml](#) is a straightforward machine parsable data serialization format designed for human readability and interaction with scripting languages. One of its reasons for popularity is that XML can sometimes be quite verbose and cumbersome. Groovy's XML capabilities make XML less verbose (e.g. through its builder notation for creating XML) and less cumbersome (e.g. its excellent XML processing [capabilities](#)). Even so, there may be times when you need to or prefer to use Yaml over XML. Here are some examples of how to use Groovy with the [JYaml](#) library.

First, reading simple lists:

```
// require(url:'http://jyaml.sourceforge.net', jar:'jyaml.jar', version:'1.0')
import org.ho.yaml.Yaml

def input = '''
- 1
- apple
- orange
'''
assert Yaml.load(input) == [1, 'apple', 'orange']
```

Reading maps:

```
// ...
input = '''
Name: Andre Agassi
Height: 5'11'' (180 cm)
Birthplace: "Las Vegas, Nevada, USA"
Turned Pro: 1986
'''

def player = Yaml.load(input)
assert player.Birthplace == "Las Vegas, Nevada, USA"
assert player['Turned Pro'] == 1986
```

Reading into classes:

```
// ...
class Staff {
def firstname, lastname, position
}

input = '''
firstname: John
lastname: Connor
position: Resistance Leader
'''

Staff s = Yaml.loadType(input, Staff)
println s.dump()
// => <Staff@c05d3b firstname=John lastname=Connor position=Resistance Leader>
```

Writing lists:

```
// ...
def list = ['a', 'b', 123456]
println Yaml.dump(list)
```

This produces:

```
---
- "a, b"
- 123456
```

Developer Guide

This page last changed on Jul 03, 2007 by [jshickey](#).

The developer guide contains information mainly of interest to the developers involved in creating Groovy and its supporting modules and tools.

Useful starting points:

- [JavaDoc](#) for Groovy internal classes written in Java
- [GroovyDoc](#) for Groovy internal classes written in Groovy
- details about the SVN [source code repository](#)
- binary distribution repositories: [Main](#), [Snapshot](#)
- local Maven 2 repositories: [Main](#) (may be empty once synced with global repositories), [Snapshot](#)
- details about the [Continuous Integration](#) servers which build Groovy around the clock
- the root [Wiki](#) page
- source [Cross Reference](#)

Other topics:

- [Building Groovy from Source](#)
- [Continuous Integration](#)
- [From source code to bytecode](#)
- [Groovy Backstage](#)
 - [Groovy Method Invokation](#)
- [Groovy Internals](#)
- [Ivy](#)
- [latest commits to our SVN trunk](#)
- [Release Process](#)
- [Setup Groovy Development Environment](#)

Building Groovy from Source

This page last changed on Oct 12, 2007 by [devijvers](#).

Prerequisites

Java Developer Kit (JDK)

You will need a [JDK 1.4.2+ \(J2SE 1.4.2+\)](#) or compatible JDK to build Groovy.

Apache Ant

To execute the build process you need to have [Apache Ant](#) version 1.7.0 (or newer) installed.

Subversion Client

To fetch the source code for the server, you will need to have a [Subversion](#) client version 1.2 (or newer, 1.4 is recommended) installed.



If you are using a source archive from the [distribution site](#) site, then you do not need to have a Subversion client installed.

Fetch the Groovy Source Code

From Subversion

There are many different protocols available to access the Groovy source code. For the complete list see the [source repository details](#) for the project.

```
svn co https://svn.codehaus.org/groovy/trunk/groovy/groovy-core
```

From a Source Archive

Select one of the `*-src.*` archives from the [distribution site](#) site and unzip it.

For example, to use the source from the Groovy 1.1-beta-2 release:

```
wget http://dist.groovy.codehaus.org/distributions/groovy-src-1.1-beta-2.zip
unzip groovy-src-1.1-beta-2.zip
```

Preparing to Build for the First Time

If you are behind a proxy firewall, you may need to set up proxy information in a `~/.ant/settings.xml` or `~/.m2/settings.xml` file:

```
<?xml version="1.0"?>
<settings>
<proxies>
<proxy>
<protocol>http</protocol>
<host>proxy.host.net</host>
<port>8080</port>
<nonProxyHosts>localhost</nonProxyHosts>
</proxy>
</proxies>
</settings>
```

If you will need to publish artifacts then you will need to have appropriate permissions with codehaus and ensure that you have stored your credentials in a `~/.ant/settings.xml` or `~/.m2/settings.xml` file of the form:

```
<?xml version="1.0"?>
<settings>
<servers>
<server>
<id>codehaus.org</id>
<username>YOUR_USER_NAME</username>
<password>YOUR_PASSWORD</password>
</server>
</servers>
</settings>
```

Building

To build everything, run tests and create a complete installation in `target/install`, run:

```
ant install
```



Useful Information

In case of `java.lang.OutOfMemoryError` try increasing the size of the heap space by setting the `ANT_OPTS` variable as follows:

```
ANT_OPTS=-Xmx512M
```

Increase the size of the heap size if required.

After this finished successfully, then you can try out the distribution that was just built. For example to play with `groovysh` you can run:

```
./target/install/bin/groovysh
```

Sometimes its desirable to skip the test execution for faster turn around. To turn off tests set the `skipTests` property, as in:

```
ant install -DskipTests=true
```

Distribution Archives

To build a Groovy distribution archive:

```
ant distribution
```

This will build everything, generate documentation and create distribution archives under `target/dist`:

- `groovy-binary-VERSION.zip`
- `groovy-docs-VERSION.zip`
- `groovy-src-VERSION.zip`



As you might have guessed `VERSION` will be the version of the project you are building, like `1.1-beta-2-SNAPSHOT` for pre-releases or `1.1-beta-2` for a released version.

Publishing Artifacts

To publish artifacts to the Maven 2 repository, run:

```
ant deploy
```

This will either publish to the [release repository](#) or the [snapshot repository](#) based on whether the POM version contains `SNAPSHOT` or not.

If deploy is failing, then check [Installing the UserTrust CA into the Java JDK](#).

Continuous Integration

This page last changed on Jan 14, 2008 by russel.

The Groovy project is extremely lucky to have several [continuous integration](#) environments available to us to give us immediate feedback whenever changes are made to Groovy. As Groovy evolves, this helps us ensure that it remains working on various platforms (including various operating systems, Java versions and to some degree different build systems, e.g. different [Ant/Maven](#) versions running on [CruiseControl](#), [Bamboo](#) and [TeamCity](#)).

At the moment the main CI server is hosted by [Canoo](#) but other versions are also hosted by [The Codehaus](#) and [JetBrains](#). Details are covered below.

Server Information

URL	http://build.canoo.com/groovy/	
Build Server	CruiseControl 2.2.0	
Operating System	Linux	
Java Version	1.5 with Ant 1.7.0	
SVN modification check	every 5 minutes	
SVN quiet period	2 minutes of SVN inactivity before build starts	
build results	http://build.canoo.com/groovy/	
artifacts	http://build.canoo.com/groovy/artifacts	
mail data feed	subscribe to SCM Mailing lists	
RSS 2.0 data feed	http://build.canoo.com/groovy/buildstatus.rss	
Admin	build-support at canoo.com	
URL	http://bamboo.ci.codehaus.org/browse/GROOVY	
Build Server	Bamboo	

Operating System	Fedora	
Java Version	1.4, 1.5, 1.6 available	

URL http:// teamcity.jetbrains.com/ viewType.html? buildTypeId=bt10 (login as guest when prompted)		
Build Server		TeamCity
Operating System		Linux, Windows, MacOS available
Java Version		1.4, 1.5, 1.6 available

From source code to bytecode

This page last changed on Sep 24, 2006 by [paulk_asert](#).

Here are some tips on how to debug what is happening on the transition from groovy source code into the generated bytecode.

artifact	transformation	artifact
source (Hello.groovy)	- GroovyLexer ->	antlr tokens
antlr tokens	- GroovyRecognizer ->	antlr ast
antlr ast	- AntlrParserPlugin ->	groovy ast
groovy ast	- AsmClassGenerator->	bytecode (Hello.class)

Note1 [groovy.g](#) is used to generate [GroovyLexer](#) and [GroovyRecognizer](#)

Note2 [GroovyRecognizer](#) is sometimes easier to understand in its [syntax diagram](#) form

Note3 [AntlrParserPlugin](#) source available.

Example

For these examples let's assume the file [Hello.groovy](#) contains

```
class Hello {
static void main(args) {
println "hello world"
}
}
```

GroovyLexer (viewing Antlr Tokens)

To view the antlr tokens that the source code has been broken into you need to do the following in groovy-core subdirectory

```
java -cp
target/install/embeddable/groovy-all-1.0-jsr-01-SNAPSHOT.jar
:target/install/lib/antlr-2.7.5.jar
org.codehaus.groovy.antlr.LexerFrame
```

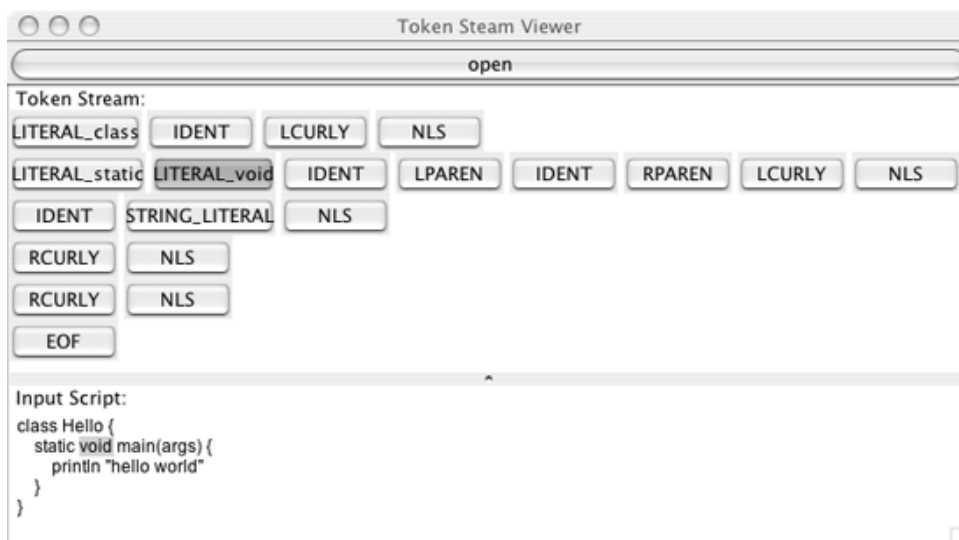

GroovyRecognizer (viewing Antlr AST)

To view the antlr AST that the recognized tokens have built

```
java -cp
target/install/embeddable/groovy-all-1.0-jsr-01-SNAPSHOT.jar
:target/install/lib/antlr-2.7.5.jar
org.codehaus.groovy.antlr.Main
-showtree Hello.groovy
```

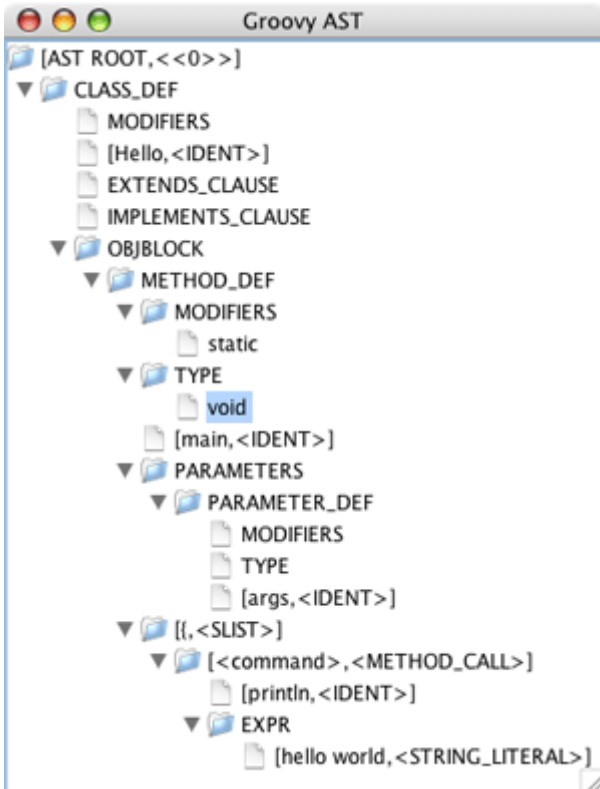

AntlrParserPlugin (viewing Groovy AST)

To view the Groovy AST that is one step closer to the generated bytecode you can generate [Hello.groovy.xml](#) using these unix commands.

This can be generated using both classic and jsr parsers, by changing the **groovy.jsr** system property. By doing this we can diff the generated Groovy AST artifacts for debugging and migration purposes.

jsr parser

```
$ export JAVA_OPTS="-Dgroovy.ast=xml -Dgroovy.jsr=true"
$ groovyc Hello.groovy
Written AST to Hello.groovy.xml
```

classic parser

```
$ export JAVA_OPTS="-Dgroovy.ast=xml -Dgroovy.jsr=false"
$ groovyc Hello.groovy
Written AST to Hello.groovy.xml
```

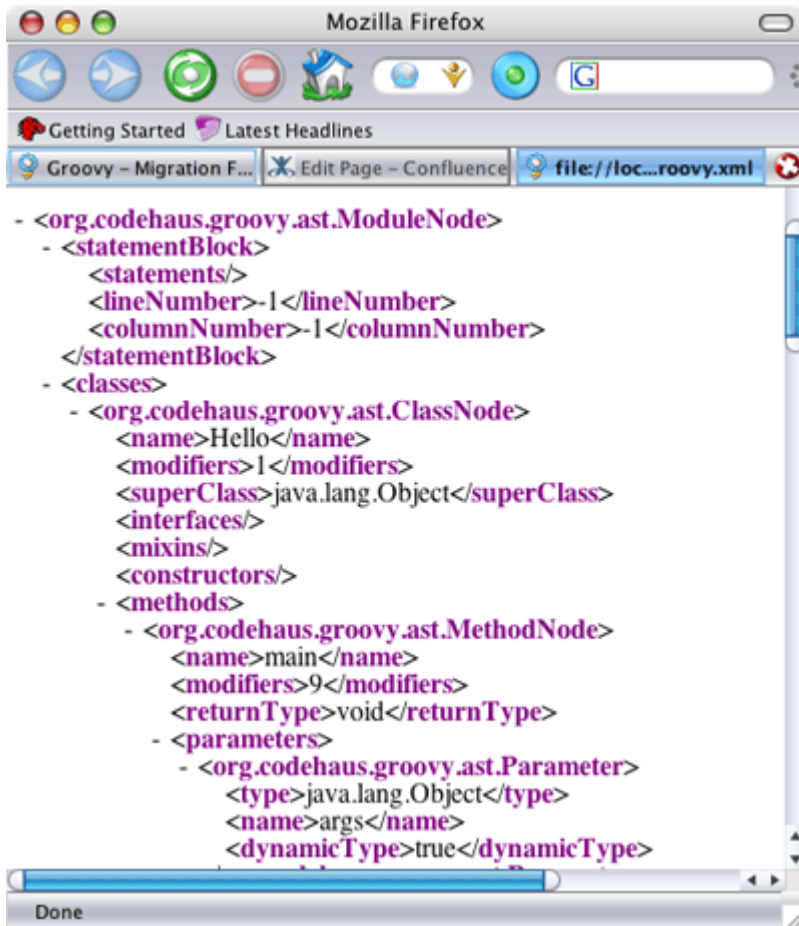
Viewing Bytecode

One interesting bytecode viewer is [jclasslib](#) which renders [Hello.class](#) in this manner...

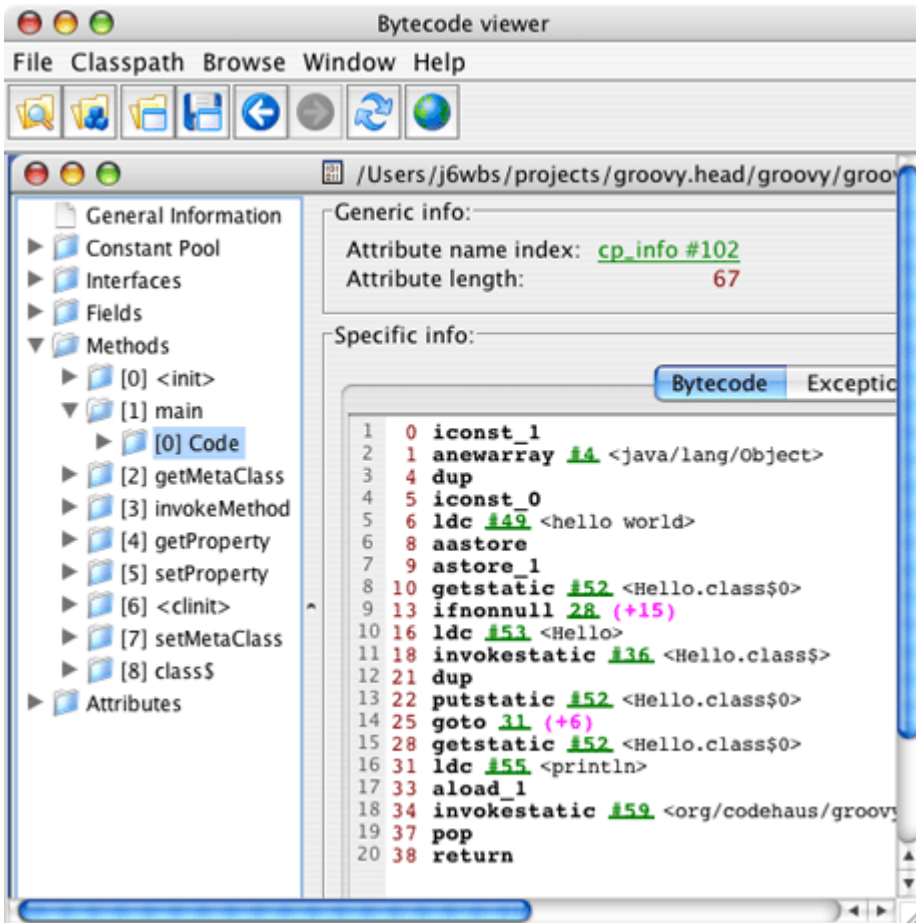

Decompiling bytecode back to Java

If, however, you are bamboozled by bytecode... The easiest to grok mechanism for reading the compiled code is to use a tool like [JAD](#) to decompile the [Hello.class](#) into a readable [Hello.java](#)

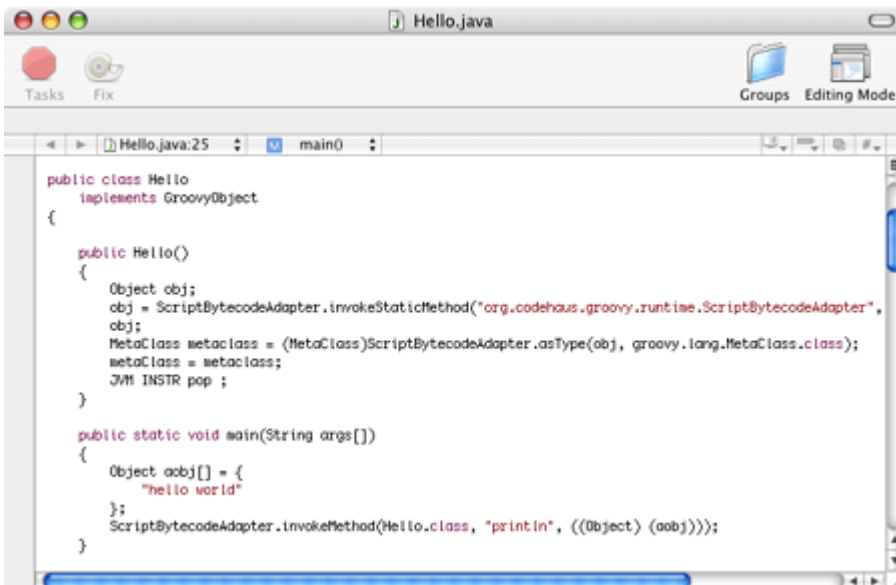

How Groovy works behind the scenes

With your Groovy scripts, you have multiple options on how to use them:

- run groovyc on them to create Java *.class files
- evaluate the script at runtime (either from a file or from a Java String)
- make your script available as Java Class-objects through the GroovyClassLoader (no *.class files generated!)

*No *.java source files are ever generated.*

All the above may seem like magic and it somehow is: the magic of imaginative, mindful software engineering.

Everything starts with the Groovy grammar.

There is the notion of the 'new' and the 'old' parser. Only the new one (as of Feb.05) is described here.

The Groovy grammar is written in terms of an ANTLR (= *ANother Tool for Language Recognition*) grammar. The tool can handle grammars of type LL(k), where the Java grammar is of type LL(2) and Groovy is of type LL(3).

The difference is in the number of tokens that the parser needs to look ahead for recognizing e.g. "==" (2 tokens for Java) or "===" (3 tokens for Groovy).

To be more correct, the problem is in recognizing the first "=" character. The parser needs to "look ahead" to derive its meaning.

ANTLR formulates the grammar in terms of "rules" that fully implement EBNF (Extended Backus-Naur Form) enriched with Java code blocks, special functions and some other things.

With the recognition of a rule, actions can be triggered that come as usual Java code. ANTLR dumps out Javacode representing a parser capable to recognize the given grammar. And this parser executes the embedded code blocks from the grammar - the "action".

Parser Generation and AST

ANTLR takes the Groovy grammar file "Groovy.g" to create the Groovy parser. When the parser is fed with the source code of a Groovy script, it produces the AST (= *Abstract Syntax Tree*) that represents that code as a run-time structure.

Byte Code Generation

From the AST, it is possible to create Java Byte Code: either for making it persistent as *.class files or for making it directly available as Class objects through the GroovyClassLoader.

This ClassGeneration is done with the help of objectweb's ASM tool. (The ASM name does not mean anything: it is just a reference to the "asm" keyword in C, which allows some functions to be implemented in assembly language.)

ASM provides a Java API to construct or modify Byte Code on a given AST.

The API for bytecode generation heavily relies on the Visitor Pattern. The main entry point for the class generation is `org.codehaus.groovy.classgen.AsmClassGenerator.java`.

It is a large class. There are `visitXYExpression` methods called when converting the AST to bytecode. For example `visitArrayExpression` is called when creating arrays in bytecode.

More Links on the topic

[Groovy Method Invokation](#)

Tools:

- <http://www.antlr.org/>
- <http://asm.objectweb.org/>

General:

- <http://compilers.iecc.com/comparch/article/99-02-109>
- http://en.wikipedia.org/wiki/Category:Parsing_algorithms
- <http://lambda.uta.edu/cse5317/spring02/notes/notes.html>

Groovy Method Invokation

This page last changed on Sep 24, 2006 by [paulk_asert](#).

Where it all starts

Say you have a Groovy code like

```
println 'hi'
```

As explained in [Groovy Backstage](#), there is bytecode generated to achieve the desired behaviour of printing to stdout.

The easiest way of looking at the generated bytecode is to groovyc your Groovy source to a class file and process it with a Java Decompiler (e.g. JAD).

see also: [From source code to bytecode](#)

The resulting code looks as follows (only the relevant snippet):

```
...
Object aobj[] = { "hi" };
ScriptBytecodeAdapter.invokeMethod(this, "println", ((Object) (aobj)));
...
```

Invokation scheme

There is a delegation scheme like

- `ScriptBytecodeAdapter.invokeMethod(...)` (static method)
 - `InvokerHelper.invokeMethod(...)` (static method)
 - `Invoker.invokeMethod(...)` (instance method called on `InvokerHelper`'s single instance)

MetaClass and MetaClassRegistry

`Invoker` calls `invokeMethod(...)` on the **MetaClass** of our class (with exceptions, see below). It finds this **MetaClass** by looking it up in the **MetaClassRegistry**.

The `Invoker` holds a single instance of this registry.



When working with the `MetaClassRegistry`, `InvokerHelper.getInstance().getMetaRegistry()` is the only instance, you should ever use.

Exceptions (when `MetaClass.invokeMethod(...)` is not used):

- for Closures, `Closure.invoke(...)` is used
- for GroovyObjects *obj* of type `GroovyInterceptable`, `obj.invokeMethod(methodName, asArray(arguments))` is called
- for any other `GroovyObject` *obj* when method invokation through its `MetaClass` fails, `obj.invokeMethod(methodName, asArray(arguments))` is called

`MetaClass.invokeMethod(...)` finally cares for the invokation, either by reflection or by dynamic bytecode generation.

Dynamic bytecode generation is supposed to be faster. For a class `MyClass` it generates `gjdk.groovy.lang.MyClass_GroovyReflector` with an `invoke` method.

Does `MyClass_GroovyReflector` contain methods according to `MyClass.groovy` that can be called directly



The cool thing about `MetaClass` is that you can dynamically add or remove methods to it. One can even replace the whole `MetaClass` in the `MetaClassRegistry`. See `ProxyMetaClass` for an example.

back to [Groovy Backstage](#)

Groovy Internals

This page last changed on May 30, 2006 by [paulk_asert](#).

This page is work in progress. It will document the internals of groovy, the ideas and the techniques used so other developers may it have more easy to contribute to groovy in the future.

Parser

Package Layout

Bytecode Hints

ClassLoader Structure

One Class One Class Loader

When are two classes the same? If the name is equal and if the class loader is equal. This means you can have multiple versions of the same class if you load the class through different class loaders. Of course this versions don't really have to be the same. This also means if you have code like

DuplicateClass.groovy

```
Class cls = foo.class
assert cls.name==Foo.class.name
assert cls==Foo.class
```

may fail because cls is not Foo. This also means calling a method like

DuplicateClass.groovy

```
def f(Foo f){
println "f(Foo) called"
}

def f(Object o){
println "f(Object) called"
}
```

with an Foo does not mean that "f(Foo) called" will be printed! This is no secret, you will find it in the language specification.

Class Loading Conventions

There are small conventions about how to do class loading in Java.

1. always return the same class for the same name
2. use your cache before asking a parent loader
3. no parent loader doesn't mean the system loader
4. ask your parent loader before trying ot load a class by yourself

Most of the loaders in groovy are violating one or more of these rules. I will explain why and how in the next sections

RootLoader

First let us start with the RootLoader. This one used used to start the console programs and is something like an advanced java launcher. When using Groovy embedded this loader is usually not used. The RootLoader sees itself as a root in a class loader tree. Against the convention to ask the parent before loading a class this loader tries to load it by itself first. Only when this fails the parent is asked. They parent is usually the system class loader then. This step was needed because of many problems with

multiple versions of libs, causing multiple classes of the same name where they are not expected, or classes loaded from the wrong libs. Because of that reason this loader may also be used in ant or maven to avoid clashes with the classes used by ant.

GroovyClassLoader

ReflectorLoader

Ivy

This page last changed on Sep 24, 2006 by [paulk_asert](#).

Done. Deleted the table since Ivy is supposed to generate those reports for us.

Checkout the example at and run it with Ivy installed.

```
svn co http://engrm.com/svn/track/trunk/codehaus/groovy/  
ant resolve
```

- [Axion](#)

Notes on Xerces 2.4.0. Ant is using Xerces 2.6.2 so I'm going to simply pull that dependency, unless you want to be sure to test against the old dependency.

Posted a question at Jayasoft about [the structure of the Ant Ivy](#).

Groovy vendor track with Ivy and pure Ant build.

<http://engrm.com/svn/track/trunk/codehaus/groovy/>

Files of particular interest.

<http://engrm.com/svn/track/trunk/codehaus/groovy/groovy.build.xml>

<http://engrm.com/svn/track/trunk/codehaus/groovy/ivy.xml>

<http://engrm.com/svn/track/trunk/codehaus/groovy/ivyconf.html>

Release Process

This page last changed on Apr 10, 2008 by [blackdrag](#).

Instructions

- Update the pdf of the online documentation and commit it
- Checkout a fresh SVN version
- Change the release version information

"files"

```
./build.properties:  
groovyVersion = 1.1-beta-3  
.pom.xml:  
<version>1.1-beta-3</version>
```

- Tag SVN with that new release

```
svn copy https://$user@svn.codehaus.org/groovy/branches/GROOVY_1_5_X/groovy https://  
$user@svn.codehaus.org/groovy/branches/GROOVY_1_5_5 -m "creating branch for 1.5.5 release"
```

- Build zips and jars using:

```
ant dist
```

You may need to set `ANT_OPTS=-Xmx512m` (or similar) if you run out of memory when running `GroovyDoc`.

- Upload all the zips (but not jars) to the WebDAV distribution site (<https://dav.codehaus.org/dist/groovy/distributions>), for example, or through `rsync` if you're authorized:

```
rsync -vlogDrzP ./target/dist/*.zip $user@groovy.codehaus.org:/projects/groovy/dist/
```

(just check they are in the right place afterwards; you may still need a webdav client to move them into the right subdirectories if something goes wrong)

- Put m2 jars into right place for uptake into repo1 (see *Publishing artifacts* on [Building Groovy from Source](#) for more details):

```
ant -DskipTests=true deploy
```

(Note: there is currently some duplicated work done by 'ant dist' above and 'ant deploy' here which we need to eventually consolidate)

- Upload the javadocs through `rsync` to the WebDAV web site, for example:

```
rsync -vlogDrzP ./target/html/* $user@groovy.codehaus.org:/projects/groovy/web/
```

- Update the download links: <http://docs.codehaus.org/display/GROOVY/Download>
- Announce the release
- Update the release version information to the next snapshot

Setup Groovy Development Environment

This page last changed on Aug 13, 2007 by [user57](#).

Steps to setup development environment for Groovy core:

1. Install JDK 1.4.2 or above (e.g. Sun JDK 5.0 version 1.5.0_06):
 - JDK is available on <http://java.sun.com>.
 - Remember to set the JAVA_HOME environment variable after installation.
 - (Optional) Add JAVA_HOME/bin to PATH for executing Java commands.
2. If you want to use Eclipse then install Eclipse 3.1 or above (e.g. Eclipse 3.2):
 - Eclipse is available on <http://www.eclipse.org>.
 - Install a Subversion-Plugin e.g.:
 - Subclipse, the plugin provided by the subversion authors, <http://subclipse.tigris.org> (Update Site is <http://subclipse.tigris.org/update>).
 - Subversive, another plugin integrating Subversion support, <http://www.polarion.org/index.php?page=overview&project=subversive> (Update Site is <http://www.polarion.org/projects/subversive/download/1.1/update-site/>).
 - or another plugin supporting Subversion.
3. If you want to build from the command line the install Ant 1.7 (possibly works with 1.6.5 but this is not properly tested):
 - Ant 1.7 is available on <http://ant.apache.org/>.
4. Extract groovy source, either:
 - If using Eclipse:
 - Decide where your workspace is (will be reference later), switch to the SVN perspective. If you are not familiar with Eclipse, in menu Help -> Welcome may help you a lot.
 - Browse [SVN](#) to know SVN information.
 - Create a new repository, extract groovy source (the folder groovy-core. You can extract it as project name groovy)
 - If not using Eclipse then from command line: `svn co http://svn.codehaus.org/groovy/trunk/groovy/groovy-core`
5. Build groovy source
 - For command line builds, simply go to the groovy-core directory you extracted, execute "ant" in command line, make sure the build success, browse groovy/target/test-reports if you got JUnit test fails.
 - For Eclipse:
 - TBA
6. Done!

FAQ

This page last changed on Aug 10, 2007 by [tomstrummer](#).

- [Class Loading](#)
- [FAQ - Classes and Object Orientation](#)
- [FAQ - Closures](#)
- [FAQ - Collections, Lists, etc.](#)
- [FAQ - GSQL](#)
- [FAQ - RegExp](#)
- [General](#)
 - [How can I edit the documentation](#)
- [Language questions](#)
 - [Can I break a Groovy statement into multiple lines anyway I want?](#)
 - [How can I dynamically add a library to the classpath](#)
 - [Why does == differ from Java](#)
- [Learning about Groovy FAQ](#)
- [Runtime vs Compile time, Static vs Dynamic](#)
- [Old FAQ](#) (Some links may be broken)

This page last changed on Mar 15, 2007 by [furashgf](#).

I'm getting an "unable to resolve class My Class" error when I try to use a class contained in external .groovy file.

If the problem goes away when you apply groovyc to the .groovy file (compiling it), and you're running on windows, the problem is probably spaces in the current directory structure. Move your files to a path without spaces (e.g., c:\source rather than c:\documents and settings\Administrator\My Documents\source).

How do I load jars and classes dynamically at runtime?

Use the groovy script's classLoader to add the jar file at runtime.

```
this.class.classLoader.rootLoader.addURL(new URL("file:///path to file"))
```

Then, use Class.forName to load the class.

```
def cls = Class.forName("com.mysql.jdbc.Driver").newInstance();
```

FAQ - Classes and Object Orientation

This page last changed on Sep 24, 2006 by [paulk_asert](#).

Classes and Object Orientation

How do you include groovy classes within other classes?

Groovy classes work exactly like java classes. For example, to include the class "TestClass" in your program, ensure that it is in a file called "TestClass.groovy," and in a path seen by your CLASSPATH environment variable (or command line). Remember that JAR files need to be included explicitly by name.

FAQ - Closures

This page last changed on Sep 24, 2006 by paulk_asert.

Closures

What problem do closures solve? Why have closures?

At one level they just allow internal iterators instead of external ones. This alone is really nice because looping is a lot cleaner. With Iterators for example you do all the work, because if you want to execute the loop of the body, you have to take responsibility for hasNext() and next().

So its basically providing the body of a loop or a callback etc which will execute within the original scope.

Anonymous classes can seem like they are in fact closures, but they have limitations that cause annoying things like having to declare all your variables as final. The compiler just creates a synthetic constructor that takes any variables you are going to reference.

For me the main benefit of closures is that they allow you to write code for collections with a lot less boilerplate.

```
accounts.findAll { it.overdrawn && !it.customer.vip }.each { account ->
account.customer.sendEmail("Pay us now!!")
}
```

FAQ - Collections, Lists, etc.

This page last changed on Apr 10, 2007 by [tomstrummer](#).

Collections, Lists, etc.

Why don't return statements work when iterating through an object?

The `{...}` in an each statement is not a normal Java block of code, but a *closure*. Closures are like classes/methods, so returning from one simply exits out of the closure, not the enclosing method.

How do I declare and initialize a list at the same time?

Syntax:

```
def x = [ "a", "b" ]
```

How do I declare and initialize a traditional array at the same time?

Syntax:

```
String[] x = [ "a", "qrs" ]
```

or

```
String[] x = [ "a", "qrs" ] as String[]
```

or

```
def x = [ "a", "qrs" ] as String[]
```

Why does `myMap.size` or `myMap.class` return null?

In Groovy, maps override the dot operator to behave the same as the `index[]` operator:

```
myMap["size"]="ONE MILLION!!!";
println myMap.size           // outputs 'ONE MILLION!!!'

//use the following:
println myMap.@size         // '1'
println myMap.size()        // '1'
println myMap.getClass()    // 'class java.util.HashMap'
```

Why is my map returning null values?

Chances are, you tried to use a variable as a key in a map literal definition. Remember, keys are interpreted as literal strings:

```
myMap = [myVar:"one"]
assert myMap["myVar"] == "one"
```

Try this (note the parentheses around the key):

```
myMap = [(myVar):"one"]
```

FAQ - RegExp

This page last changed on Dec 20, 2006 by [marcdexet](#).

RegExp

matcher.matches() returns false

Why this code fails ?

```
def matcher = "/home/me/script/test.groovy" =~ /\.groovy/  
assert matcher.matches()
```

Because of you think you do something like "*Oh dear it contains the word!*", but you're confusing *matches* with *find*

From Javadoc: [http://java.sun.com/j2se/1.5.0/docs/api/java/util/regex/Matcher.html#matches\(\)](http://java.sun.com/j2se/1.5.0/docs/api/java/util/regex/Matcher.html#matches())

```
public boolean matches()  
Attempts to match the entire region against the pattern.
```

...

So `"/\.groovy/` is just a subsequence.
You must use

```
def matcher = "/home/me/script/test.groovy" =~ /\.*\.groovy/
```

What is the difference between =~ and ==~ ?

- `~` is the [Pattern](#) symbol.
- `=~` means [matcher.find\(\)](#)
- `==~` means [matcher.matches\(\)](#)

Pattern, Matcher ?

A pattern is not very usefull alone. He's just waiting input to process through a *matcher*.

```
def pattern = ~/groovy/  
def matcher = pattern.matcher('my groovy buddy')
```

Matcher can say a lot of thing to you:

- if the *entire* input sequence matches the pattern, with [matcher.matches\(\)](#) ;
- if just a *subsequence* of the input sequence matches the pattern, with [matcher.find\(\)](#).

A matcher with `/groovy/` pattern **finds** a matching subsequence in the 'my groovy buddy' sequence.
On the contrary the whole sequence doesn't **match** the pattern.

```
def m = c.matcher('my groovy buddy')  
assert m.find()  
assert m.matches() == false
```

Application: to filter a list of names.

```
def list = ['/a/b/c.groovy', 'myscript.groovy', 'groovy.rc', 'potatoes']  
// find all items whom a subsequence matches /groovy/  
println list.findAll{ it =~ /groovy/ } // => ["groovy", "/a/b/c.groovy", "myscript.groovy",  
"groovy.rc", "groovy."]  
  
// find all items who match exactly /groovy/  
println list.findAll{ it ==~ /groovy/ } // => ["groovy"]  
  
// find all items who match fully /groovy\..*/ ('groovy' with a dot and zero or more char trailing)  
println list.findAll{ it ==~ /groovy\..*/ } // => ["groovy.rc", "groovy."]
```

A little tilde headache ? Remember like this

~	the pattern
=~	roughly as the pattern (easy to write)
==~	more than roughly, exactly as the pattern (think hard...)

General

This page last changed on Apr 26, 2004 by [jstrachan](#).

- [How can I edit the documentation](#)

How can I edit the documentation

This page last changed on Apr 26, 2004 by [jstrachan](#).

The entire Groovy website is stored in this [wiki](#)

The home page is called [Home](#) then the navigation links on the left are on a magic page called [Navigation](#) and the top right navigation links are on a magic page called [QuickLinks](#).

Hopefully now anyone can contribute to the documentation.

If you ever edit a page and wonder why its not yet been updated on the <http://groovy.codehaus.org/> site well it could be cached. To view a latest greatest page just add the 'refresh=1' to your URL. e.g.

<http://groovy.codehaus.org/?refresh=1>

Language questions

This page last changed on Aug 13, 2007 by sberka.

- [Can I break a Groovy statement into multiple lines anyway I want?](#)
- [How can I dynamically add a library to the classpath](#)
- [Why does == differ from Java](#)

Can I break a Groovy statement into multiple lines anyway I want?

This page last changed on Aug 13, 2007 by [sberka](#).

The simple answer is no. For example, a code

```
aaa = 7
-1
assert aaa == 6
```

will fail. See more details about new lines in the [Groovy Language Specification](#) (section 3.11.1 Significant Newlines).

How can I dynamically add a library to the classpath

This page last changed on May 25, 2007 by [blackdrag](#).

Use `getRootLoader().addUrl([Some URI])`

See [How to get a RootLoader](#)

See [RootLoader javadoc](#)

Sample: Dynamic JDBC Driver Loading

```
import Groovy.sql.Sql
this.class.classLoader.rootLoader.addURL( new URL("file:///d:/drivers/ojdbc14.jar") )
def driver="oracle.jdbc.driver.OracleDriver";
def sql = Sql.newInstance("jdbc:oracle:thin:@hostname:port:schema", "scott", "tiger", driver);
```

Why does == differ from Java

This page last changed on Oct 07, 2006 by [jbaumann](#).

This is described [here](#).

Basically in Java == with primitive types means use equality. For object types == means test identity.

We found when working with Groovy that if we kept those semantics and folks used dynamic typing as follows

```
def x = 2 * 2
if (x == 4) {
  ...
}
```

They would get surprising results, as they often mean equality based on value, such as in the above, rather than identity. Indeed folks rarely ever use identity comparisons.

So to avoid many common gotchas and confusions, we've made == mean equals, the meaning most developers use, and we use this for both primitive types and for object types and across both static and dynamic typing to simplify things.

Currently if you really want to compare identities of the objects, use the method is(), which is provided by every object.

```
if (x.is(4)) {
  ... // never true
}
```

The above condition is never true, since the Integer object in x (which is the result of the computation above) is not identical to the Integer object with value 4 that has been created for the comparison.

Learning about Groovy FAQ

This page last changed on Dec 15, 2004 by jez.

This FAQ hopes to answer common questions for users of Groovy

What is Groovy?

- [Groovy](#) is trying to provide a high level language (like Ruby, Python or Dylan) that maps cleanly to Java bytecode.
- It needs to work with Java objects, and the root of all the object trees is [java.lang.Object](#).
- The syntax will be Java friendly, but doesn't have to be backwards compatible.
- Groovy will sit on top of [J2SE](#).

Where can I get more information on Groovy?

The current user documentation for Groovy is available from <http://groovy.codehaus.org>

What if the documentation is wrong?

Anybody can change these pages, just click on the little **Edit** link on the right of each page (you then have to signup/login if you haven't already).

How can I get a binary version of Groovy?

Download latest distribution as a [zip](#) or [tgz](#) file and then follow the [installation instructions](#)

How do I embed Groovy in my own programs?

Download latest [groovy-all.jar](#) and place it in your classpath.

How can I grab the sources?

You can either [browse](#) the CVS repository, or if you are happy with using [cvs](#)

```
cvs -d :pserver:anonymous@cvs.groovy.codehaus.org:/home/projects/groovy/scm login
cvs -z3 -d :pserver:anonymous@cvs.groovy.codehaus.org:/home/projects/groovy/scm co groovy
```

Runtime vs Compile time, Static vs Dynamic

This page last changed on Aug 16, 2007 by [tomstrummer](#).

Runtime vs Compile time, Static vs Dynamic

I misspelled a method call, but it still compiled. What gives?

Take this simple script as an example:

Greet.groovy

```
class Greet {
def salute( person ) { println "Hello ${person.name}!" }
def welcome( Place location ) { println "Welcome to ${location.state}!" }
}

g = new Greet()
g.salude()           //misspelling
g.welcome( 123 )    //wrong argument type
```

Note that running `groovyc Greet.groovy` does not produce any errors. Instead, a `MissingMethodException` is thrown at runtime.

This is because Groovy is a dynamic language. Several other things could be happening to make this code valid at runtime. Using the `MetaClass`, you could add a `salude()` method to the `Greet` class at runtime. You could also add a `state` property to `Number`, which would make the `welcome(..)` call valid. See [ExpandoMetaClass](#) and [Groovy Categories](#).

Will I get a performance boost if I statically type all of my fields and methods?

Actually, no. The way Groovy method selection is done, it actually takes **longer** if you provide lots of static type information. This could possibly change in the future, but as of Groovy 1.1 this is not the case. See [this thread](#) for more info.

But can't you add warnings so I can see missing methods at compile time?

In theory, we could. It would *only* work for methods available at compile time, and *only* for fields and parameters that you have strongly typed. But as we mentioned above, that hurts performance! Plus, there are a number of frameworks that rely heavily on dynamic methods (i.e. [GORM](#)). In this case, you would get gobs of warnings, and likely just start ignoring them because it is just noise.

It might be scary to do away with all of your static typing and compile time checking at first. 😊 But many Groovy veterans will attest that it makes the code cleaner, easier to refactor, and, well, more *dynamic*. You should make all efforts to use unit tests to verify your intended behavior. Also keep in mind that Groovy also offers a slew of [features](#) to make unit testing easier as well.

Can't we provide some sort of "NotDynamic" flag to speed up method invocation?

This has been discussed on the mailing list many times before. Although it has not been ruled out entirely, there are many implications to such a 'feature'. The primary focus right now is to improve the performance of normal, dynamic Groovy. Groovy is already performant enough for "most" use cases. If you see a performance bottleneck in your code, the typical optimization path is to factor out those pieces to Java code, and call them from Groovy. See [this thread](#) and [this one](#).

Getting Started Guide

This page last changed on Sep 27, 2006 by paulk_asert.

- [Beginners Tutorial](#)
 - [Tutorial 1 - Getting started](#)
 - [Tutorial 2 - Code as data, or closures](#)
 - [Tutorial 3 - Classes and Objects](#)
 - [Tutorial 4 - Regular expressions basics](#)
 - [Tutorial 5 - Capturing regex groups](#)
 - [Tutorial 6 - Groovy SQL](#)
- [Differences to Other Languages](#)
 - [Differences from Java](#)
 - [Differences from Python](#)
 - [Differences from Ruby](#)
- [Download](#)
- [Feature Overview](#)
 - [Groovlets](#)
 - [Groovy Beans](#)
 - [Groovy Templates](#)
 - [GroovyMarkup](#)
- [For those new to both Java and Groovy](#)
 - [JN0025-Starting](#)
 - [JN0515-Integers](#)
 - [JN0525-Decimals](#)
 - [JN0535-Floats](#)
 - [JN0545-Dates](#)
 - [JN1015-Collections](#)
 - [JN1025-Arrays](#)
 - [JN1035-Maps](#)
 - [JN1515-Characters](#)
 - [JN1525-Strings](#)
 - [JN1535-Patterns](#)
 - [JN2015-Files](#)
 - [JN2025-Streams](#)
 - [JN2515-Closures](#)
 - [JN2525-Classes](#)
 - [JN2535-Control](#)
 - [JN3015-Types](#)
 - [JN3025-Inheritance](#)
 - [JN3035-Exceptions](#)
 - [JN3515-Interception](#)
 - [JN3525-MetaClasses](#)
 - [JN3535-Reflection](#)
- [Groovy for the Office](#)
- [Groovy Quick Start Project](#)
- [Quick Start](#)
 - [Installing Groovy](#)
 - [Installing Groovy and Grails on the Eee PC](#)
 - [Running](#)

Beginners Tutorial

This page last changed on Sep 27, 2006 by [paulk_asert](#).

Welcome on board the Groovy flight. Before proceeding through the content of this tutorial, please make sure to fasten your seat belt, before we take off to higher levels of grooviness...

This page is intended to get you started with Groovy, following a trail of a few tutorial labs on various topics mainly oriented towards typical use of scripting languages for data crunching or text manipulation.

Graham Miller, a Groovy aficionado, has been teaching a class of business on data crunching. And he was kind enough to contribute back to the Groovy project this great set of educational material to help you learn Groovy, using some nice examples to massage, summarize and analyze data – a task for which Groovy is a quite good fit.

The topics covered are about Groovy basics, text parsing, regular expressions, SQL, and web-scraping:

- [Getting started](#)
- [Code as data](#)
- [Classes and Objects](#)
- [Regular Expressions](#)
- [Capturing groups](#)
- [Groovy SQL](#)

If you are a Java developer

- you might want to check on the [Differences from Java](#)
- also there are a few [Things to remember](#)

Tutorial 1 - Getting started

This page last changed on Oct 25, 2007 by andrew.listochkin@yahoo.com.

Getting Started

Setting up your Java environment

Groovy requires Java, so you need to have a version available (1.4 or greater is required). Here are the steps if you don't already have Java installed:

- Get the latest Java distribution from the <http://java.sun.com> website.
- Run the installer.
- Set the JAVA_HOME environment variables. On Windows, follow these steps:
 - Open the System control panel
 - Click the Advanced tab
 - Click the Environment Variables button
 - Add a new System variable with the name JAVA_HOME and the value of the directory Java was installed in (mine is C:\Program Files\Java\jdk1.5.0_04)
 - Optionally add %JAVA_HOME%\bin to your system path
(Note: as an alternative to setting a system environment variable, you can create yourself a '.bat' or '.cmd' file which sets the variable. You then need to run that batch file in any console window in which you wish to run Java and double clicking on '.bat' or '.cmd' files containing Java invocation instructions won't work. If you are unsure about what this means, follow the earlier instructions.)
Note: JDK 1.5 is required for version 1.1-rc-1. In earlier versions of JDK (notably 1.4.2) the compiler throws an exception:
*nested exception is org.codehaus.groovy.runtime.InvokerInvocationException:
java.lang.NoSuchMethodError: java.lang.String.replace(Ljava/lang/CharSequence;Ljava/lang/CharSequence;)Ljava/lang/String;
The method "replace" was introduced in JDK 1.5 and is not supported in earlier versions. This is also a reason why GRails framework doesn't run on JRE 1.4

Setting up your Groovy environment

Download the Groovy installer or binaries from the [downloads](#) page and follow the installation instructions. (There is currently an issue where you cannot have spaces in the path where Groovy is installed under windows. So, instead of accepting the default installation path of "c:\Program Files \Groovy" you will want to change the path to something like "c:\Groovy")

OR

- Get a copy of the Groovy distribution from the [website](#), and copy it to some place on your hard drive.
- Unzip the groovy archive to some logical place on your hard drive, I have mine in C:\dev\groovy-1.0-jsr-06
- Set the GROOVY_HOME environment variables. On Windows, follow these steps:
 - Add a new System variable with the name GROOVY_HOME and the value of the directory groovy was installed in (mine is C:\dev\groovy-1.0-jsr-06)
 - Start a command prompt, and type "set" and hit return to see that your environment variables were set correctly.
- Optionally add %GROOVY_HOME%\bin to your system path
- Try opening groovyConsole.bat by double clicking on the icon in the bin directory of the Groovy distribution. If it doesn't work, open a command prompt, and change to the bin directory and run it from there to see what the error message is.

Setting up optional jar files

You may wish to obtain optional jar files, either corresponding to Groovy modules (see module documentation for details) or corresponding to other Java classes you wish to make use of from Groovy. Some possibilities are listed below:

Name	From	Description
<code>jtds-version.jar</code>	http://jtds.sourceforge.net	Database driver for SQL Server and/or Sybase
<code>hsqldb-version.jar</code>	http://www.hsqldb.org/	Database driver for HSQLDB, a 100% Java database

The recommended way for making Groovy be aware of your additional jar files is to place them in a predefined location. Your Groovy install should include a file called `groovy-starter.conf`. Within that file, make sure a line such as

```
load ${user.home}/.groovy/lib/*
```

is not commented out. The `user.home` system property is set by your operating system. (Mine is `C:\Document and Settings\paul`. Now simply place your jar files into the `.groovy/lib` directory. (Note: as an alternative, you can set up a `CLASSPATH` variable and make sure it mentions all of your additional jar files, otherwise Groovy works fine with an empty or no `CLASSPATH` variable.)

Hello, World

In the top part of the window of the `groovyConsole`, type the following

```
println "Hello, World!"
```

And then type `<CTRL-R>`.

Notice that the text gets printed out in the OS console window (the black one behind the `groovyConsole` window) and the bottom part of the `groovyConsole` says:

```
groovy> println "Hello, World!"
null
```

The line starting with `"groovy>"` is just the text of what the console processed. The `"null"` is what the expression "evaluated to". Turns out the expression to print out a message doesn't have any "value" so the `groovyConsole` printed `"null"`.

Next try something with an actual value. Replace the text in the console with:

```
123+45*67
```

or your favorite arithmetic expression, and then type `<CTRL-R>` (I'm going to stop telling you to hit `<CTRL-R>`, I think you get the idea). Now the "value" printed at the bottom of the `groovyConsole` has more meaning.

Variables

You can assign values to variables for later use. Try the following:

```
x = 1
println x
```

```
x = new java.util.Date()
println x
```

```
x = -3.1499392
println x
```

```
x = false
println x

x = "Hi"
println x
```

Lists and Maps

The Groovy language has built-in support for two important data types, lists and maps (Lists can be operated as arrays in Java language). Lists are used to store ordered collections of data. For example an integer list of your favorite integers might look like this:

```
myList = [1776, -1, 33, 99, 0, 928734928763]
```

You can access a given item in the list with square bracket notation (indexes start at 0):

```
println myList[0]
```

Should result in this output:

```
1776
```

You can get the length of the list with the "size" method:

```
println myList.size()
```

Should print out:

```
6
```

But generally you shouldn't need the length, because unlike Java, the preferred method to loop over all the elements in an list is to use the "each" method, which is described below in the "Code as Data" section.

Another native data structure is called a map. A map is used to store "associative arrays" or "dictionaries". That is unordered collections of heterogeneous, named data. For example, let's say we wanted to store names with IQ scores we might have:

```
scores = [ "Brett":100, "Pete":"Did not finish", "Andrew":86.87934 ]
```

Note that each of the values stored in the map is of a different type. Brett's is an integer, Pete's is a string, and Andrew's is a floating point number. We can access the values in a map in two main ways:

```
println scores["Pete"]
println scores.Pete
```

Should produce the output:

```
Did not finish
Did not finish
```

To add data to a map, the syntax is similar to adding values to an list. For example, if Pete re-took the IQ test and got a 3, we might:

```
scores["Pete"] = 3
```

Then later when we get the value back out, it will be 3.

```
println scores["Pete"]
```

should print out 3.

Also as an aside, you can create an empty map or an empty list with the following:

```
emptyMap = [:]
emptyList = []
```

To make sure the lists are empty, you can run the following lines:

```
println emptyMap.size()
println emptyList.size()
```

Should print a size of 0 for the List and the Map.

Conditional Execution

One of the most important features of any programming language is the ability to execute different code under different conditions. The simplest way to do this is to use the "if" construct. For example:

```
amPM = Calendar.getInstance().get(Calendar.AM_PM)
if (amPM == Calendar.AM)
{
println("Good morning")
} else {
println("Good evening")
}
```

Don't worry too much about the first line, it's just some code to determine whether it is currently before noon or after. The rest of the code executes as follows: first it evaluates the expression in the parentheses, then depending on whether the result is "true" or "false" it executes the first or the second code block. See the section below on boolean expressions.

Note that the "else" block is not required, but the "then" block is:

```
amPM = Calendar.getInstance().get(Calendar.AM_PM)
if (amPM == Calendar.AM)
{
println("Have another cup of coffee.")
}
```

Boolean Expressions

There is a special data type in most programming languages that is used to represent truth values, "true" and "false". The simplest boolean expressions are simply those words. Boolean values can be stored in variables, just like any other data type:

```
myBooleanVariable = true
```

A more complex boolean expression uses one of the boolean operators:

```
* ==
* !=
* >
* >=
* <
* <=
```

Most of those are probably pretty intuitive. The equality operator is "==" to distinguish from the assignment operator "=". The opposite of equality is the "!=" operator, that is "not equal"

So some examples:

```
titanicBoxOffice = 1234600000
titanicDirector = "James Cameron"
```

```
trueLiesBoxOffice = 219000000
trueLiesDirector = "James Cameron"
```

```
returnOfTheKingBoxOffice = 752200000
returnOfTheKingDirector = "Peter Jackson"
```

```
theTwoTowersBoxOffice = 581200000
theTwoTowersDirector = "PeterJackson"
```

```
titanicBoxOffice > returnOfTheKingBoxOffice // evaluates to true
titanicBoxOffice >= returnOfTheKingBoxOffice // evaluates to true
titanicBoxOffice >= titanixBoxOffice // evaluates to true
titanicBoxOffice > titanixBoxOffice // evaluates to false
```



```
titanicBoxOffice + trueLiesBoxOffice < returnOfTheKingBoxOffice + theTwoTowersBoxOffice //
evaluates to false

titanicDirector > returnOfTheKingDirector // evaluates to false, because "J" is before "P"
titanicDirector < returnOfTheKingDirector // evaluates to true
titanicDirector >= "James Cameron" // evaluates to true
titanicDirector == "James Cameron" // evaluates to true
```

Boolean expressions are especially useful when used in conjunction with the "if" construct. For example:

```
if (titanicBoxOffice + trueLiesBoxOffice > returnOfTheKingBoxOffice + theTwoTowersBoxOffice)
{
println(titanicDirector + " is a better director than " + returnOfTheKingDirector)
}
```

An especially useful test is to test whether a variable or expression is null (has no value). For example let's say we want to see whether a given key is in a map:

```
suvMap = ["Acura MDX": "\$36,700", "Ford Explorer": "\$26,845"]
if (suvMap["Hummer H3"] != null)
{
println("A Hummer H3 will set you back "+suvMap["Hummer H3"]);
}
```

Generally null is used to indicate the lack of a value in some location.

Debugging and Troubleshooting Tips

- Print out the class of a variable that you're interested in with `myVar.getClass()`. Then look up the documentation for that class.
- If you're having trouble with a complex expression, pare it down to a simpler expression and evaluate that. Then build up to your more complex expression.
- Try restarting the `groovyConsole` (this will clear out all the variables so you can start over).
- Look for the topic you're interested in in the Groovy [User Guide](#)

If you are a Java developer

- you might want to check on the [Differences from Java](#)
- also there are a few [Things to remember](#)

Tutorial 2 - Code as data, or closures

This page last changed on Mar 08, 2008 by [paulk_asert](#).

Closures

One of the things that makes Groovy different than most compiled languages is that you can create functions that are first class objects. That is you can define a chunk of code and then pass it around as if it were a string or an integer. Check out the following code:

```
square = { it * it }
```

The curly braces around the expression "it * it" tells the Groovy compiler to treat this expression as code. In the software world, this is called a "closure". In this case, the designator "it" refers to whatever value is given to the function. Then this compiled function is assigned to the variable "square" much like those above. So now we can do something like this:

```
square(9)
```

and get the value 81.

This is not very interesting until we find that we can pass this function "square" around as a value. There are some built in functions that take a function like this as an argument. One example is the "collect" method on arrays. Try this:

```
[ 1, 2, 3, 4 ].collect(square)
```

This expression says, create an array with the values 1,2,3 and 4, then call the "collect" method, passing in the closure we defined above. The collect method runs through each item in the array, calls the closure on the item, then puts the result in a new array, resulting in:

```
[ 1, 4, 9, 16 ]
```

For more methods you can call with closures as arguments, see the [Groovy GDK documentation](#).

By default closures take 1 parameter called "it", you can also create closures with named parameters. For example the method Map.each() can take a closure with two variables, to which it binds the key and associated value:

```
printMapClosure = { key, value -> println key + "=" + value }  
[ "yue" : "wu", "lane" : "burks", "sudha" : "saseethiaseeleethialeselan" ].each(printMapClosure)
```

Produces:

```
yue=wu  
lane=burks  
sudha=saseethiaseeleethialeselan
```

More Closure Examples

Here are a few more closure examples. This first one shows a couple of things. First, the closure is interacting with a variable outside itself. That is, the closure's purpose is to put together the parts of a stock order held in the array orderParts, by adding (appending) it to the variable fullString. The variable fullString is not in the closure. The second thing that is different about this example is that the closure is "anonymous", meaning that it is not given a name, and is defined in the place where the each method is called.

```
fullString = ""  
orderParts = ["BUY", 200, "Hot Dogs", "1"]  
orderParts.each {  
  fullString += it + " "  
}  
  
println fullString
```

You can probably guess what this prints out.

The next example is another anonymous closure, this time, summing up the values stored in a map.

```
myMap = ["asdf": 1 , "qwer" : 2, "sdfg" : 10]

result = 0
myMap.keySet().each( { result+= myMap[it] } )
println result
```

Dealing with Files

Reading data from files is relatively simple. First create a text file, and call it myfile.txt. It doesn't matter what's in it, just type some random text into it and save it on your C: drive in the \temp directory. Then type the following code in the groovyConsole:

```
myFileDirectory = "C:\\temp\\"
myFileName = "myfile.txt"
myFile = new File(myFileDirectory + myFileName)

printFileLine = { println "File line: " + it }

myFile.eachLine( printFileLine )
```

This should print out every line in the file prefixed with "File line: ". The first two lines of the code simply declare variables to specify where the file is located. The variable names don't have any special significance, and as you can see, all we do is combine them when we use them. Note that because the backslash character has special meaning in groovy, you have to use two of them to tell it that you "really" mean a backslash.

The next line that starts "myFile =" creates a new File object. An object is simply a collection of related methods and data. For example, a file object might have data describing its location, in this case "C:\temp\myfile.txt", and maybe a method to delete the file if it exists. In this case the only method we are going to use is the eachLine method, which we call in the last line of code. The line before that is a simple closure definition, that you have seen several times by this point.

Dealing with strings

Strings in Groovy have all the same functionality of Java strings. That is, a Groovy string is just a Java string with a few extra things added to it. Because of that, we can refer to the [Java documentation for the String class](#) to find out some of the interesting things we can do with it. For example, look in the section entitled "Method Summary" at the description for the "split" method. This method does something very useful, which is to split a string based on a regular expression. We will talk more about regular expressions later, but for now the only thing you have to know is that the simplest regular expression is a single character. So let's say that we want to split up the components of the date "2005-07-04", so that we can add one to the year to get the date of next fourth of July. We might:

```
stringDate = "2005-07-04"
dateArray = stringDate.split("-")
year = dateArray[0].toInteger()
year = year + 1
newDate = year + "-" + dateArray[1] + "-" + dateArray[2]
```

This code brings together a bunch of things we have talked about before. There are two new things, first is the use of the split method on a String. Second is the call of toInteger() on a String. This call to toInteger simply tells Groovy that you want to treat that data as a number rather than a String. See what happens if you run the same code without ".toInteger()" at the end of the third line.

Another thing you might notice is that toInteger is not listed in the Java documentation for string. That is because it is one of the extra features that Groovy has added to Strings. You can also take a look at the documentation for the [Groovy extensions to Java objects](#).

Tutorial 3 - Classes and Objects

This page last changed on Apr 24, 2006 by [paulk_asert](#).

Classes and Objects

- Objects are collections of related code and data
- Everything in Java and Groovy can be considered an object
- A class is a higher level description of an object.
 - For example a 10-Q is a specification developed by the SEC and can be thought of as a "Class". A quarterly report issued by **IBM** for Q2 2005 can be thought of as an object of the class 10-Q.
- Documentation for java classes can be found [here](#)
- Documentation for Groovy extensions to Java classes can be found [here](#)

Tutorial 4 - Regular expressions basics

This page last changed on Sep 27, 2006 by paulk_asert.

Regular Expressions

Regular expressions are the Swiss Army knife of text processing. They provide the programmer the ability to match and extract **patterns** from strings. The simplest example of a regular expression is a string of letters and numbers. And the simplest expression involving a regular expression uses the `==~` operator. So for example to match Dan Quayle's spelling of 'potato':

```
"potatoe" ==~ /potatoe/
```

If you put that in the groovyConsole and run it, it will evaluate to true. There are a couple of things to notice. First is the `==`

`~` operator, which is similar to the `==` operator, but matches patterns instead of computing exact equality. Second is that the regular expression is enclosed in `/`'s. This tells groovy (and also anyone else reading your code) that this is a regular expression and not just a string.

But let's say that we also wanted to match the correct spelling, we could add a `'?'` after the `'e'` to say that the `e` is optional. The following will still evaluate to true.

```
"potatoe" ==~ /potatoe?/
```

And the correct spelling will also match:

```
"potato" ==~ /potatoe?/
```

But anything else will not match:

```
"motato" ==~ /potatoe?/
```

So this is how you define a simple boolean expression involving a regular expression. But let's get a little bit more tricky. Let's define a method that tests a regular expression. So for example, let's write some code to match Pete Wisniewski's last name:

```
def checkSpelling(spellingAttempt, spellingRegularExpression)
{
  if (spellingAttempt ==~ spellingRegularExpression)
  {
    println("Congratulations, you spelled it correctly.")
  } else {
    println("Sorry, try again.")
  }
}
```

```
theRegularExpression = /Wisniewski/
checkSpelling("Wisniewski", theRegularExpression)
checkSpelling("Wisnewski", theRegularExpression)
```

There are a couple of new things we have done here. First is that we have defined a function (actually a method, but I'll use the two words interchangeably). A function is a collection of code similar to a closure. Functions always have names, whereas closures can be "anonymous". Once we define this function we can use it over and over later.

In this function the **if** statement in bold tests to see if the parameter `spellingAttempt` matches the regular expression given to the function by using the `==~` operator.

Now let's get a little bit more tricky. Let's say we also want to match the string if the name does not have the `'w'` in the middle, we might:

```
theRegularExpression = /Wisniew?ski/
checkSpelling("Wisniewski", theRegularExpression)
checkSpelling("Wisnieski", theRegularExpression)
checkSpelling("Wisniewewski", theRegularExpression)
```

The single `?` that was added to the `spellingRegularExpression` says that the item directly before it (the character `'w'`) is optional. Try running this code with different spellings in the variable `spellingAttempt` to prove to yourself that the only two spellings accepted are now `"Wisniewski"` and `"Wisnieski"`. (Note that you'll have to leave the definition of `checkSpelling` at the top of your `groovyConsole`)

The `*?*` is one of the characters that have special meaning in the world of regular expressions. You should probably assume that any punctuation has special meaning.

Now let's also make it accept the spelling if `"ie"` in the middle is transposed. Consider the following:

```
theRegularExpression = /Wisn(ie|ei)w?ski/
checkSpelling("Wisniewski", theRegularExpression)
checkSpelling("Wisnieski", theRegularExpression)
checkSpelling("Wisniewewski", theRegularExpression)
```

Once again, play around with the spelling. There should be only four spellings that work, `"Wisniewski"`, `"Wisneiwski"`, `"Wisnieski"` and `"Wisneiski"`. The bar character `'|'` says that either the thing to the left or the thing to the right is acceptable, in this case `"ie"` or `"ei"`. The parentheses are simply there to mark the beginning and end of the interesting section.

One last interesting feature is the ability to specify a group of characters all of which are ok. This is done using square brackets `*[]*`. Try the following regular expressions with various misspellings of Pete's last name:

```
theRegularExpression = /Wis[abcd]niewski/ // requires one of 'a', 'b', 'c' or 'd'
theRegularExpression = /Wis[abcd]?niewski/ // will allow one of 'a', 'b', 'c' or 'd', but not
required (like above)
theRegularExpression = /Wis[a-zA-Z]niewski/ // requires one of any upper\_- or lower-case letter
theRegularExpression = /Wis[^abcd]niewski/ // requires one of any character that is ''not'' 'a',
'b', 'c' or 'd'
```

The last one warrants some explanation. If the first character in the square brackets is a `*^*` then it means anything but the characters specified in the brackets.

The operators

So now that you have a sense for how regular expressions work, here are the operators that you will find helpful, and what they do:

Regular Expression Operators

a?	matches 0 or 1 occurrence of *a*	'a' or empty string
a*	matches 0 or more occurrences of *a*	empty string or 'a', 'aa', 'aaa', etc
a+	matches 1 or more occurrences of *a*	'a', 'aa', 'aaa', etc
a b	match *a* or *b*	'a' or 'b' -
.	match any single character	'a', 'q', 'l', '_', '+', etc
[woeirjds]	match any of the named characters	'w', 'o', 'e', 'i', 'r', 'j', 's', 'd'
[1-9]	match any of the characters in the range	'1', '2', '3', '4', '5', '6', '7', '8', '9'
[^13579]	match any characters not named	even digits, or any other character

(ie)	group an expression (for use with other operators)	'ie'
^a	match an *a* at the beginning of a line	'a'
a\$	match an *a* at the end of a line	'a'

There are a couple of other things you should know. If you want to use one of the operators above to mean the actual character, like you want to match a question mark, you need to put a '\ ' in front of it. For example:

```
// evaluates to true, and will for anything ending in a question mark (that doesn't have a question mark in it)
"How tall is Angelina Jolie?" =~ /^[^?]+\?/
```

This is your first really ugly regular expression. (The frequent use of these in PERL is one of the reasons it is considered a "write only" language). By the way, google knows how tall [she is|http://www.google.com/search?hl=en&q=how+tall+is+angelina+jolie&btnG=Google+Search]. The only way to understand expressions like this is to pick it apart:

/	[^?]	+	?	/
begin expression	any character other than '?'	more than one of those	a question mark	end expression

So the use of the \ in front of the ? makes it refer to an actual question mark.

Tutorial 5 - Capturing regex groups

This page last changed on Sep 27, 2006 by paulk_asert.

Capture groups

One of the most useful features of Groovy is the ability to use regular expressions to "capture" data out of a regular expression. Let's say for example we wanted to extract the location data of Liverpool, England from the following data:

```
locationData = "Liverpool, England: 53° 25? 0? N 3° 0? 0?"
```

We could use the `split()` function of string and then go through and strip out the comma between Liverpool and England, and all the special location characters. Or we could do it all in one step with a regular expression. The syntax for doing this is a little bit strange. First, we have to define a regular expression, putting anything we are interested in in parentheses.

```
myRegularExpression = /([a-zA-Z]+), ([a-zA-Z]+): ([0-9]+). ([0-9]+). ([0-9]+). ([A-Z]) ([0-9]+). ([0-9]+). ([0-9]+)./
```

Next, we have to define a "matcher" which is done using the `=~` operator:

```
matcher = ( locationData =~ myRegularExpression )
```

The variable `matcher` contains a `java.util.regex.Matcher` as enhanced by groovy. You can access your data just as you would in Java from a `Matcher` object. A groovier way to get your data is to use the `matcher` as if it were an array--a two dimensional array, to be exact. A two dimensional array is simply an array of arrays. In this case the first "dimension" of the array corresponds to each match of the regular expression to the string. With this example, the regular expression only matches once, so there is only one element in the first dimension of the two-dimensional array. So consider the following code:

```
matcher[0]
```

That expression should evaluate to:

```
["Liverpool, England: 53° 25? 0? N 3° 0? 0?", "Liverpool", "England", "53", "25", "0", "N", "3", "0", "0"]
```

And then we use the second dimension of the array to access the capture groups that we're interested in:

```
if (matcher.matches()) {
    println(matcher.getCount()+ " occurrence of the regular expression was found in the string.");
    println(matcher[0][1] + " is in the " + matcher[0][6] + " hemisphere. (According to: " + matcher[0][0] + ")")
}
```

Notice that the extra benefit that we get from using regular expressions is that we can see if the data is well-formed. That is if **locationData** contained the string "Could not find location data for Lima, Peru", the if statement would not execute.

Non-matching Groups

Sometimes it is desirable to group an expression without marking it as a capture group. You can do this by enclosing the expression in parentheses with `?:` as the first two characters. For example if we wanted to reformat the names of some people, ignoring middle names if any, we might:

```
names = [
    "Graham James Edward Miller",
    "Andrew Gregory Macintyre"
]
```

```
printClosure = {
    matcher = (it =~ /(.*?)?: (.*)/); // notice the non-matching group in the middle
```



```

if (matcher.matches())
println(matcher[0][2]+", "+matcher[0][1]);
}
names.each(printClosure);

```

Should output:

```

Miller, Graham
Macintyre, Andrew

```

That way, we always know that the last name is the second matcher group.

Replacement

One of the simpler but more useful things you can do with regular expressions is to replace the matching part of a string. You do that using the `replaceFirst()` and `replaceAll()` functions on `java.util.regex.Matcher` (this is the type of object you get when you do something like `myMatcher = ("a" += /b/);`).

So let's say we want to replace all occurrences of Harry Potter's name so that we can resell J.K. Rowlings books as Tanya Grotter novels (yes, someone tried this, Google it if you don't believe me).

```

excerpt = "At school, Harry had no one. Everybody knew that Dudley's gang hated that odd Harry
Potter "+
"in his baggy old clothes and broken glasses, and nobody liked to disagree with Dudley's gang.";
matcher = (excerpt =~ /Harry Potter/);
excerpt = matcher.replaceAll("Tanya Grotter");

matcher = (excerpt =~ /Harry/);
excerpt = matcher.replaceAll("Tanya");
println("Publish it! "+excerpt);

```

In this case, we do it in two steps, one for Harry Potter's full name, one for just his first name.

Reluctant Operators

The operators `?`, `+`, and `*` are by default "greedy". That is, they attempt to match as much of the input as possible. Sometimes this is not what we want. Consider the following list of fifth century popes:

```

popesArray = [
"Pope Anastasius I 399-401",
"Pope Innocent I 401-417",
"Pope Zosimus 417-418",
"Pope Boniface I 418-422",
"Pope Celestine I 422-432",
"Pope Sixtus III 432-440",
"Pope Leo I the Great 440-461",
"Pope Hilarius 461-468",
"Pope Simplicius 468-483",
"Pope Felix III 483-492",
"Pope Gelasius I 492-496",
"Pope Anastasius II 496-498",
"Pope Symmachus 498-514"
]

```

A first attempt at a regular expression to parse out the name (without the sequence number or modifier) and years of each pope might be as follows:

```
/Pope (.*) (? : .* )? ([0-9]+) - ([0-9]+)/
```

Which splits up as:

/	Pope	(.*)	(? : .*)?	[0-9]+	-	[0-9]+	/
---	------	------	------------	--------	---	--------	---

begin expression	Pope	capture some characters	non-capture group: space and some characters	capture a number	-	capture a number	end expression
------------------	------	-------------------------	--	------------------	---	------------------	----------------

We hope that then the first capture group would just be the name of the pope in each example, but as it turns out, it captures too much of the input. For example the first pope breaks up as follows:

/	Pope	(.*)	(?:.*)?	([0-9]+)	-	([0-9]+)	/
begin expression	Pope	Anastasius I		399	-	401	end expression

Clearly the first capture group is capturing too much of the input. We only want it to capture Anastasius, and the modifiers should be captured by the second capture group. Another way to put this is that the first capture group should capture as little of the input as possible to still allow a match. In this case it would be everything until the next space. Java regular expressions allow us to do this using "reluctant" versions of the *, + and ? operators. In order to make one of these operators reluctant, simply add a ? after it (to make *?, +? and ??). So our new regular expression would be:

```
/Pope (.*)?(?:.*)? ([0-9]+)-([0-9]+)/
```

So now let's look at our new regular expression with the most difficult of the inputs, the one before Pope Hilarius (a real jokester), breaks up as follows:

/	Pope	(.*)?	(?:.*)?	([0-9]+)	-	([0-9]+)	/
begin expression	Pope	Leo	I the Great	440	-	461	end expression

Which is what we want.

So to test this out, we would use the code:

```
popesArray = [
"Pope Anastasius I 399-401",
"Pope Innocent I 401-417",
"Pope Zosimus 417-418",
"Pope Boniface I 418-422",
"Pope Celestine I 422-432",
"Pope Sixtus III 432-440",
"Pope Leo I the Great 440-461",
"Pope Hilarius 461-468",
"Pope Simplicius 468-483",
"Pope Felix III 483-492",
"Pope Gelasius I 492-496",
"Pope Anastasius II 496-498",
"Pope Symmachus 498-514"
]

myClosure = {
myMatcher = (it =~ /Pope (.*)?(?:.*)? ([0-9]+)-([0-9]+)/);
if (myMatcher.matches())
println(myMatcher[0][1]+": "+myMatcher[0][2]+" to "+myMatcher[0][3]);
}
popesArray.each(myClosure);
```

Try this code with the original regular expression as well to see the broken output.

Tutorial 6 - Groovy SQL

This page last changed on Sep 23, 2007 by [masakisakurai](#).

Groovy SQL

This section some content from this [GroovySQL article](#), by Andrew Glover. If some of the references to JDBC don't make sense, don't worry. There is one new language construct that is used below, which is the inclusion of variables in string definitions. For example try the following:

```
piEstimate = 3;
println("Pi is about ${piEstimate}");
println("Pi is closer to ${22/7}");
```

As you can see, in a string literal, Groovy interprets anything inside `${}` as a groovy expression.

This feature is used extensively below.

Performing a simple query

Your first Groovy SQL code consists of three lines.

```
import groovy.sql.Sql
sql = Sql.newInstance("jdbc:jtds:sqlserver://serverName/dbName-CLASS;domain=domainName",
"username",
"password", "net.sourceforge.jtds.jdbc.Driver")
sql.eachRow("select * from tableName", { println it.id + " -- ${it.firstName} --" });
```

The first line is a Java import. It simply tells Groovy the full name of the Sql object. The second line creates a new connection to the SQL database, and stores the connection in the variable sql.

This code is written for a jTDS connection to a MS SQL Server database. You will need to adjust all the parameters to newInstance to connect to your database, especially **username** and **password**.

Finally the third line calls the eachRow method of sql, passing in two arguments, the first being the query string, the second being a closure to print out some values.

Notice that in the closure the fields of "it" are accessed in two different ways. The first is as a simple field reference, accessing the id field of it. The second is the included Groovy expression mentioned above.

So the output from a row might look like:

```
001 -- Lane --
```

Retrieving a single value from DB

If all you need is a value of one or a few columns of a single row in the DB, you could do this

```
row = sql.firstRow("select columnA, columnB from tableName")
println "Row: columnA = ${row.columnA} and columnB = ${row.columnB}"
```

Doing more complex queries

The previous examples are fairly simple, but GroovySql is just as solid when it comes to more complex data manipulation queries such as insert, update, and delete queries. For these, you wouldn't necessarily want to use closures, so Groovy's Sql object provides the execute and executeUpdate methods instead. These methods are reminiscent of the normal JDBC statement class, which has an execute and an executeUpdate method as well.

Here you see a simple insert that uses variable substitution again with the `${}` syntax. This code simply inserts a new row into the people table.

```
firstName = "yue"
lastName = "wu"
sql.execute("insert into people (firstName, lastName) "+
" values ('${firstName}', ${lastName})")
```

Note that in this example you have to put quotes around any string data in the insert statement. This is generally not a great way to do things (think about what happens if your data contains a quote character). A better way to do the same thing is to use prepared statements as follows:

```
firstName = "yue"
lastName = "wu"
sql.execute("insert into people (firstName, lastName) "+
" values (?,?)", [firstName, lastName])
```

The data that you want to insert is replaced with "?" in the insert statement, and then the values are passed in as an array of data items. Updates are much the same in that they utilize the executeUpdate method. Notice, too, that in Listing 8 the executeUpdate method takes a list of values that will be matched to the corresponding ? elements in the query.

```
comment = "Lazy bum"
sql.executeUpdate("update people set comment = ? where id=002", [comment])
```

Deletes are essentially the same as inserts, except, of course, that the query's syntax is different.

```
sql.execute("delete from word where word_id = ?" , [5])
```

Differences to Other Languages

This page last changed on Jul 04, 2007 by [paulk_asert](#).

- [Differences from Java](#)
- [Differences from Python](#)
- [Differences from Ruby](#)

Differences from Java

This page last changed on Jan 09, 2008 by [glaforge](#).

Groovy tries to be as natural as possible for Java developers. We've tried to follow the principle of least surprise when designing Groovy, particularly for developers learning Groovy who've come from a Java background.

Here we list all the major differences between Java and Groovy.

Default imports

All these packages and classes are imported by default, i.e. you do not have to use an explicit `import` statement to use them:

- `java.io.*`
- `java.lang.*`
- `java.math.BigDecimal`
- `java.math.BigInteger`
- `java.net.*`
- `java.util.*`
- `groovy.lang.*`
- `groovy.util.*`

Common gotchas

Here we list the common things you might trip over if you're a Java developer starting to use Groovy.

- `==` means equals on all types. In Java there's a wierd part of the syntax where `==` means equality for primitive types and `==` means identity for objects. Since we're using autoboxing this would be very confusing for Java developers (since `x == 5` would be mostly false if `x` was 5 😊). So for simplicity `==` means `equals()` in Groovy. If you really need the identity, you can use the method "is" like `foo.is(bar)`. This does not work on null, but you can still use `==` here: `foo==null`.
- `in` is a keyword. So don't use it as a variable name.
- When declaring array you can't write

```
int[] a = {1,2,3};
```

you need to write

```
int[] a = [1,2,3]
```

- If you were used to write a for loop which looked like

```
for (int i=0; i < len; i++) {...}
```

in groovy you can use that too, but you can use only one count variable. Alternatives to this are

```
for (i in 0..len-1) {...}
```

or

```
for (i in 0..<len) {...}
```

or

```
len.times {...}
```

Things to be aware of

- Semicolons are optional. Use them if you like (though you must use them to put several statements on one line).
- The `return` keyword is optional.
- You can use the `this` keyword inside static methods (which refers to this class).
- Methods and classes are public by default.

- Protected in Groovy has the same meaning as protected in Java, i.e. you can have friends in the same package and derived classes can also see protected members.
- Inner classes are not supported at the moment. In most cases you can use [closures](#) instead.
- The `throws` clause in a method signature is not checked by the Groovy compiler, because there is no difference between checked and unchecked exceptions.
- You will not get compile errors like you would in Java for using undefined members or passing arguments of the wrong type. See [Runtime vs Compile time, Static vs Dynamic](#).

Uncommon Gotchas

Java programmers are used to semicolons terminating statements and not having [closures](#). Also there are instance initializers in class definitions. So you might see something like:

```
class Trial {
private final Thing thing = new Thing ( ) ;
{ thing.doSomething ( ) ; }
}
```

Many Groovy programmers eschew the use of semicolons as distracting and redundant (though others use them all the time - it's a matter of coding style). A situation that leads to difficulties is writing the above in Groovy as:

```
class Trial {
private final thing = new Thing ( )
{ thing.doSomething ( ) }
}
```

This will throw a `MissingMethodException`!

The issue here is that in this situation the newline is not a statement terminator so the following block is treated as a [closure](#), passed as an argument to the `Thing` constructor. Bizarre to many, but true. If you want to use instance initializers in this sort of way, it is effectively mandatory to have a semicolon:

```
class Trial {
private final thing = new Thing ( ) ;
{ thing.doSomething ( ) }
}
```

This way the block following the initialized definition is clearly an instance initializer.

Another document lists some [pitfalls](#) you should be aware of and give some advice on best practices to avoid those pitfalls.

New features added to Groovy not available in Java

- [closures](#)
- native [syntax](#) for lists and maps
- [GroovyMarkup](#) and GPath support
- native support for [regular expressions](#)
- polymorphic [iteration](#) and powerful [switch statement](#)
- dynamic and static typing is supported - so you can omit the type declarations on methods, fields and variables
- you can embed expressions inside [strings](#)
- lots of new helper methods added to the [JDK](#)
- simpler syntax for writing [beans](#) for both properties and adding event listeners
- [safe navigation](#) using the `?.` operator, e.g. `"variable?.field"` and `"variable?.method()"` - no more nested ifs to check for null clogging up your code

Differences from Python

This page last changed on Dec 06, 2007 by [pliszka](#).

General

Python	Groovy
<code>repr(x)</code>	<code>x.inspect(), x.dump()</code>
<code>x.y if x else None</code>	<code>x?.y</code>
<code>"%(foo)s" % locals()</code>	<code>"\${foo}"</code>

Lists

Python	Groovy
<code>not x</code>	<code>!x</code> <code>x.empty</code>
<code>len(x)</code>	<code>x.size()</code>
<code>for item, idx in enumerate(x): ...</code>	<code>x.eachWithIndex { item, idx -> ... }</code>

Maps

Python	Groovy
<code>{}</code>	<code>[:]</code> // an empty map
Depends: d if used like: for k in d: list(d) if list needed d.[iter]keys() explicitly	<code>d.keySet()</code>
<code>d.[iter]values()</code>	<code>d.values()</code>
<code>[k+1 for k in d]</code>	<code>d.collect { k, v -> k+1 }</code>
<code>d = dict(zip(k, v))</code>	<code>k = 1..3</code> <code>v = 'a'..'c'</code> <code>d = [:]; k.eachWithIndex { it, i -> d[it] = v[i] }</code> <code>println d // [1:"a", 2:"b", 3:"c"]</code>

Ranges/Slices

Python	Groovy
<code>range(3)</code>	<code>0..<3</code>
<code>range(1, 3+1)</code>	<code>1..3</code>
<code>range(0, 10, 2)</code>	not represented as a data type but you can use

	<code>0.step(10, 2) {...}</code>
<code>"abcdef"[3:]</code>	<code>"abcdef"[3..-1]</code>

Object access

Python	Groovy
<code>m = 'strip'; getattr(' ! ', m)()</code>	<code>m = 'trim'; ' ! '."\$m"()</code>
<code>args = ('a', 2); 'abcabc'.find(*args)</code>	<code>args = ['a', 2]; 'abcabc'.indexOf(*args)</code>

Differences from Ruby

This page last changed on Jul 04, 2007 by [paulk_asert](#).

The core abstract programming model of Ruby and Groovy are very similar: everything is an object, there is a MOP in control of all activity, and closures are the core structuring tool after classes. Ruby uses the Ruby library, Groovy uses the Java library with some additions of its own. This is the biggest difference but it is a huge difference. Syntactically, things like:

```
File.open( 'blah' ) { | file | puts( file.read ) }
```

becomes:

```
println ( new File ( 'blah' ).text )
```

which doesn't show that the Groovy closures syntax is:

```
{ file -> doSomething ( file ) }
```

which is slightly different from Ruby, but does show that sometimes Groovy has a different approach to certain things compared to Ruby. So in moving from Ruby to Groovy, there are gotchas.

Download

This page last changed on Apr 17, 2008 by [fepede](#).

Stable Releases

Groovy 1.5.5 is the latest official stable release ([Release Notes](#)).

Groovy 1.5.5

Download zip: [Binary Release](#) | [Source Release](#)

Download Ubuntu/Debian package: [Binary Release](#)

Download Fedora/RHEL/CentOS package: [Binary Release](#)

Download documentation: [JavaDoc and zipped online documentation](#)

Groovy 1.5.4

Download zip: [Binary Release](#) | [Source Release](#)

Download Ubuntu/Debian package: [Binary Release](#)

Download Windows-Installer: [Binary Release](#)

Download Fedora/RHEL/CentOS package: [Binary Release](#)

Download documentation: [JavaDoc and zipped online documentation](#)

Groovy 1.5.1

Download zip: [Binary Release](#) | [Source Release](#)

Download Ubuntu/Debian package: [Binary Release](#)

Download openSUSE 10.2 packages: [Binary Release](#) , [Repository](#)

Download openSUSE 10.3 packages: [Binary Release](#) , [Repository](#)

Download Windows-Installer: [Binary Release](#)

Download documentation: [JavaDoc and zipped online documentation](#)

Once you've downloaded the distribution, please read the [installation instructions](#).

Groovy 1.0

If you still need to use the old Groovy 1.0, here are the links you may be interested in:

Download zip: [Binary Release](#) | [Source Release](#)

Download unofficial Ubuntu/Debian package: [Binary Release](#)

Download Windows-Installer: [Binary Release](#)

Download tar/gz: [Binary Release](#) | [Source Release](#)

Download Javadoc: [Javadoc zip](#)

Upcoming Beta Versions

The Groovy 1.5.5 stable release is the latest release. No milestone releases for the next version of Groovy have yet been released.

Maven Repositories

If you wish to embed Groovy in your application, you may just prefer to point to your favourite maven repositories or the [codehaus maven repository](#). You should consult the individual pom files for the exact details but here is a summary of the main supported artifactIds and groupIds:

Groovy 1.5.0 and all post Groovy 1.0 releases (milestone releases)

Available in the [Maven 2](#) repositories.

<pre><groupId>org.codehaus.groovy</groupId> <artifactId>groovy</artifactId> <version>x.y.z</version></pre>	<p>Treats Antlr and ASM as standard dependencies. Only useful if you happen to also use the same versions of these jars yourself as it will save you having two copies of these jars. Optional dependencies are marked as optional. You may need to include some of the optional dependencies to use some features of Groovy, e.g. AntBuilder, GroovyMBeans, etc.</p>
<pre><groupId>org.codehaus.groovy</groupId> <artifactId>groovy-all</artifactId> <version>x.y.z</version></pre>	<p>Includes jarjar versions of Antlr and ASM and Commons-CLI. Allows you or your other dependencies (e.g. hibernate) to use other versions of these jars. Optional dependencies are marked as optional. You may need to include some of the optional dependencies to use some features of Groovy, e.g. AntBuilder, GroovyMBeans, etc.</p>
<pre><groupId>org.codehaus.groovy</groupId> <artifactId>groovy-all-minimal</artifactId> <version>x.y.z</version></pre>	<p>Includes jarjar versions of Antlr and ASM. Does not include Commons-CLI or any optional dependencies. Not suitable by itself if you want to use any tools which do command-line processing, e.g. groovyc, GroovyShell, ...</p>

Previous stable release: Groovy 1.0

Available in the [Maven 1](#) and [Maven 2](#) repositories.

<pre><groupId>groovy</groupId> <artifactId>groovy</artifactId> <version>1.0</version></pre>	<p>Treats Antlr and ASM as standard dependencies. Only useful if you happen to also use the same versions of these jars yourself as it will save you having two copies of these jars. Dependencies mandated for all optional parts of Groovy, e.g. AntBuilder, GroovyMBeans, etc.</p>
<pre><groupId>groovy</groupId> <artifactId>groovy-all</artifactId> <version>1.0</version></pre>	<p>Includes jarjar versions of Antlr and ASM. Allows you or your other dependencies (e.g. hibernate) to use other versions of these jars. Dependencies mandated for all optional parts of Groovy, e.g. AntBuilder, GroovyMBeans, etc.</p>
<pre><groupId>groovy</groupId> <artifactId>groovy-all-minimal</artifactId> <version>1.0</version></pre>	<p>Includes jarjar versions of Antlr and ASM. Does not include any optional dependencies.</p>

For historical purposes, the releases candidates for 1.0 are also available by using the appropriate version instead of 1.0 in the above version tag.

Snapshot Releases

In addition to the stable and milestone releases you can find intermediate SNAPSHOT releases at the [codehaus snapshot maven repository](#).

Other ways to get Groovy

If you're on Windows, you can also use the [NSIS Windows installer](#).

You may download other distributions of Groovy from [this site](#).

If you prefer to live on the bleeding edge, you can also grab the [source code from SVN](#).

If you are an IDE user, you can just grab the latest [IDE plugin](#) and follow the plugin installation instructions.

Feature Overview

This page last changed on Sep 27, 2006 by [paulk_asert](#).

- [Groovlets](#)
- [Groovy Beans](#)
- [Groovy Templates](#)
- [GroovyMarkup](#)

Groovlets

This page last changed on Jul 03, 2007 by [jamel](#).

You can write normal Java servlets in Groovy (i.e. Groovlets).
There is also a

[GroovyServlet](#)

which automatically compile your .groovy source files, turn them into bytecode, load the Class and cache it until you change the source file.

Here's a simple example to show you the kind of thing you can do from a Groovlet.
Notice the use of implicit variables to access the session, output & request.

```
import java.util.Date

if (session == null) {
    session = request.getSession(true);
}

if (session.counter == null) {
    session.counter = 1
}

println """
<html>
<head>
<title>Groovy Servlet</title>
</head>
<body>
Hello, ${request.remoteHost}: ${session.counter}! ${new Date()}
</body>
</html>
"""
session.counter = session.counter + 1
```

Or, do the same thing using MarkupBuilder:

```
import java.util.Date
import groovy.xml.MarkupBuilder





if (session == null) {
    session = request.getSession(true);
}

if (session.counter == null) {
    session.counter = 1
}

html.html { // html is implicitly bound to new MarkupBuilder(out)
    head {
        title("Groovy Servlet")
    }
    body {
        p("Hello, ${request.remoteHost}: ${session.counter}! ${new Date()}")
    }
}
session.counter = session.counter + 1
```

Implicit variables

The following variables are ready for use in Groovlets:

variable name	bound to	note
request	ServletRequest	-
response	ServletResponse	-
context	ServletContext	unlike Struts
application	ServletContext	unlike Struts
session	getSession(false)	can be null! see  A
out	response.getWriter()	see  B
sout	response.getOutputStream()	see  B
html	new MarkupBuilder(out)	see  B

 A The session variable is only set, if there was already a session object. See the 'if (session == null)' checks in the examples above.

 B These variables cannot be re-assigned inside a Groovlet. They are bound on first access, allowing to e.g. calling methods on the 'response' object before using 'out'.

Setting up groovylets

Put the following in your web.xml:

```
<servlet>
<servlet-name>Groovy</servlet-name>
<servlet-class>groovy.servlet.GroovyServlet</servlet-class>
</servlet>

<servlet-mapping>
<servlet-name>Groovy</servlet-name>
<url-pattern>*.groovy</url-pattern>
</servlet-mapping>
```

Then all the groovy jar files into WEB-INF/lib. You should only need to put the **groovy.jar**, the **antlr.jar** and the **asm.jar**. Or copy the **groovy-all-xyz.jar** into WEB-INF/lib - this *almost* all jar contains the antlr and asm jars.

Now put the .groovy files in, say, the root directory (i.e. where you would put your html files). The groovy servlet takes care of compiling the .groovy files.

So for example using tomcat you could edit tomcat/conf/server.xml like so:

```
<Context path="/groovy" docBase="c:/groovy-servlet"/>
```

Then access it with <http://localhost:8080/groovy/hello.groovy>

Groovy Beans

This page last changed on Jul 03, 2007 by [jamel](#).

GroovyBeans are JavaBeans but using a much simpler syntax. Here's an example:

```
import java.util.Date

class Customer {
  // properties
  Integer id
  String name
  Date dob

  // sample code
  static void main(args) {
    def customer = new Customer(id:1, name:"Gromit", dob:new Date())
    println("Hello ${customer.name}")
  }
}

Hello Gromit
```

Notice how the properties look just like public fields. You can also set named properties in a bean constructor in Groovy. In Groovy, fields and properties have been merged so that they act and look the same. So, the Groovy code above is equivalent to the following Java code:

```
import java.util.Date;

public class Customer {
  // properties
  private Integer id;
  private String name;
  private Date dob;

  public Integer getId() {
    return this.id;
  }

  public String getName() {
    return this.name;
  }

  public Date getDob() {
    return this.dob;
  }

  public void setId(Integer id) {
    this.id = id;
  }

  public void setName(String name) {
    this.name = name;
  }

  public void setDob(Date dob) {
    this.dob = dob;
  }

  // sample code
  public static void main(String[] args) {
    Customer customer = new Customer();
    customer.setId(1);
    customer.setName("Gromit");
    customer.setDob(new Date());
  }
}
```

```
println("Hello " + customer.getName());
}
}
```

Property and field rules

When Groovy is compiled to bytecode, the following rules are used.

- If the name is declared with an access modifier (public, private or protected) then a field is generated.
- A name declared with no access modifier generates a private field with public getter and setter (i.e. a property).
- If a property is declared final the private field is created final and no setter is generated.
- You can declare a property and also declare your own getter or setter.
- If you want a private or protected property you have to provide your own getter and setter which must be declared private or protected.

So, for example, you could create a read only property or a public read-only property with a protected setter like this:

```
class Foo {
// read only property
final String name = "John"

// read only property with public getter and protected setter
Integer amount
protected void setAmount(Integer amount) { this.amount = amount }

// dynamically typed property
def cheese
}
```

Note that properties need *some* kind of identifier: e.g. a variable type ("String") or untyped using the "def" keyword.

Closures and listeners

Though Groovy doesn't support anonymous inner classes, it is possible to define action listeners inline through the means of closures. So instead of writing in Java:

```
Processor deviceProc = ...
deviceProc.addControllerListener(new ControllerListener() {
public void controllerUpdate(ControllerEvent ce) {
...
}
}
```

You can do that in Groovy with a closure:

```
// Add a closure for a particular method on the listener interface
deviceProc.controllerUpdate = { ce -> println "I was just called with event $ce" }
```

Notice how the closure is for a *method* on the listener interface (controllerUpdate), and *not for the interface itself* (ControllerListener). This technique means that Groovy's listener closures are used like a ListenerAdapter where only one method of interest is overridden. Beware: mistakenly misspelling the method name to override or using the interface name instead can be tricky to catch, because Groovy's parser may see this as a property assignment rather than a closure for an event listener.

This mechanism is heavily used in the Swing builder to define event listeners for various components and listeners. The JavaBeans introspector is used to make event listener methods available as properties which can be set with a closure:

The Java Beans introspector (java.beans.Introspector) which will look for a BeanInfo for your bean or create one using its own naming conventions. (See the Java Beans spec for details of the naming

conventions it uses if you don't provide your own BeanInfo class). We're not performing any naming conventions ourselves - the standard Java Bean introspector does that for us.

Basically the BeanInfo is retrieved for a bean and its [EventSetDescriptors](#) are exposed as properties (assuming there is no clash with regular beans). It's actually the [EventSetDescriptor.getListenerMethods\(\)](#) which is exposed as a writable property which can be assigned to a closure.

Groovy Templates

This page last changed on Jan 07, 2008 by [paulk_asert](#).

Introduction

Groovy supports multiple ways to generate text dynamically including [GStrings](#), `printf` if you are using Java 5, and [MarkupBuilder](#) just to name a few. In addition to these, there is a dedicated template framework which is well-suited to applications where the text to be generated follows the form of a static template.

Template framework

The template framework in Groovy consists of a `TemplateEngine` abstract base class that engines must implement and a `Template` interface that the resulting templates they generate must implement.

Included with Groovy are several template engines:

- `SimpleTemplateEngine` – for basic templates
- `GStringTemplateEngine` – stores the template as writable closures (useful for streaming scenarios)
- `XmlTemplateEngine` – works well when the template and output are valid XML

SimpleTemplateEngine

Shown here is the `SimpleTemplateEngine` that allows you to use JSP-like scriptlets (see example below), script, and EL expressions in your template in order to generate parameterized text. Here is an example of using the system:

```
import groovy.text.SimpleTemplateEngine

def text = 'Dear "${firstname} $lastname",\nSo nice to meet you in <% print city %>.\nSee you in
${month},\n${signed}'

def binding = ["firstname":"Sam", "lastname":"Pullara", "city":"San Francisco", "month":"December",
"signed":"Groovy-Dev"]

def engine = new SimpleTemplateEngine()
template = engine.createTemplate(text).make(binding)

def result = 'Dear "Sam Pullara",\nSo nice to meet you in San Francisco.\nSee you in December,
\nGroovy-Dev'

assert result == template.toString()
```

While it is generally not deemed good practice to mix processing logic in your template (or view), sometimes very simple logic can be useful. E.g. in the example above, we could change this:

```
$firstname
```

to this (assuming we have set up a static import for `capitalize`):

```
${capitalize(firstname)}
```

or this:

```
<% print city %>
```

to this:

```
<% print city == "New York" ? "The Big Apple" : city %>
```

Also, just an advanced usage note if you happen to be embedding your template directly in your script (as we did above). Because the template string itself will be parsed by Groovy before it is passed to the templating framework, you have to escape any backslashes inside `GString` expressions or scriptlet

'code' that are entered as part of a Groovy program. E.g. if we wanted quotes around *The Big Apple* above, we would use:

```
<% print city == "New York" ? "\\\"The Big Apple\\\"" : city %>
```

Similarly, if we wanted a newline, we would use:

```
\\n
```

in any GString expression or scriptlet 'code' that appears inside a Groovy script. A normal "\\n" is fine within the static template text itself or if the entire template itself is in an external template file. (Note: the necessity to have this extra slash may go away in a future version of Groovy if we can find an easy way to support such a change.)

GStringTemplateEngine

As an example of using the `GStringTemplateEngine`, here is the example above done again (with a few changes to show some other options). First we will store the template in a file this time:

test.template

```
Dear "${firstname $lastname}",
So nice to meet you in <% out << (city == "New York" ? "\"The Big Apple\"" : city) %>.
See you in ${month},
${signed}
```

Note that we used `out` instead of `print` to support the streaming nature of `GStringTemplateEngine`. Because we have the template in a separate file, there is no need to escape the backslashes. Here is how we call it:

```
def f = new File('test.template')
engine = new GStringTemplateEngine()
template = engine.createTemplate(f).make(binding)
println template.toString()
```

and here is the output:

```
Dear "Sam Pullara",
So nice to meet you in "The Big Apple".
See you in December,
Groovy-Dev
```

You can also plug in other templating solutions, e.g. [GFreeMarker](#), [Velocity](#), [StringTemplate](#), [Canvas](#) and others.

If you wish to combine templating with Ant processing, consider [Gpp](#).

Using TemplateServlet to serve single JSP-like HTML files



Mind the gap! Ehm, meaning the difference between Groovlets and Templates.

The [TemplateServlet](#) just works the opposite as the [Groovlets](#) ([GroovyServlet](#)) does. Here, your source is HTML (or any other, fancy template files) and the template framework will generate a Groovy script on-the-fly. This script could be saved to a `.groovy` file and served by the `GroovyServlet` (and the `GroovyScriptEngine`), but after generation, the template is evaluated and responded to the client.

Here is a simple example `helloworld.html` file which is not validating and does not have a `head` element. But it demonstrates, how to let Groovy compile and serve your HTML files to web clients. The tag syntax close to JSP and should be easy to read:

```
<html>
<body>
<% 3.times { %>
```

```

Hello World!
<% } %>
<br>
<% if (session != null) { %>
My session id is ${session.id}
<% } else println "No session created." %>
</body>
</html>

```

The first Groovy block - a for loop - spans the `HelloWorld!` text. Guess what happens? And the second Groovy statement prints the servlet's session id - if there is a session available. The variable `session` is one of some default bound keys. More details reveals the documentation of [ServletBinding](#).

Here is some sample code using <http://jetty.mortbay.org> servlet container. With jetty6.0, copy `jetty-6.1.3.jar` and `jetty-util-6.1.3.jar` into `$HOME/.groovy/lib`, create a tiny web server with the following. To test it, add your above **helloworld.html** file into your current directory and browse <http://localhost:1234/helloworld.html>

```

import org.mortbay.jetty.*
import org.mortbay.jetty.servlet.*
import groovy.servlet.*

def server = new Server(1234)
def root = new Context(server, "/", Context.SSESSIONS)
root.setResourceBase(".")
root.addServlet(new ServletHolder(new TemplateServlet()), "*.html")
server.start()

```

Here is a similiar **web.xml** example.

```

<web-app>

<servlet>
<servlet-name>Groovlet</servlet-name>
<servlet-class>groovy.servlet.GroovyServlet</servlet-class>
</servlet>
<servlet>
<servlet-name>Template</servlet-name>
<servlet-class>groovy.servlet.TemplateServlet</servlet-class>
</servlet>

<servlet-mapping>
<servlet-name>Groovlet</servlet-name>
<url-pattern>*.groovy</url-pattern>
</servlet-mapping>
<servlet-mapping>
<servlet-name>Template</servlet-name>
<url-pattern>*.html</url-pattern>
</servlet-mapping>
<servlet-mapping>
<servlet-name>Template</servlet-name>
<url-pattern>*.gsp</url-pattern>
</servlet-mapping>

</web-app>

```

Further reading

[Article on templating with Groovy templates](#)
[Article on templating with Groovlets and TemplateServlets](#)
[Blog about combining Groovy and FreeMarker](#)

GroovyMarkup

This page last changed on Aug 04, 2006 by [paulk_asert](#).

Note: the following examples are snippets no ready to run examples.

Groovy has native support for various markup languages from XML, HTML, SAX, W3C DOM, Ant tasks, Swing user interfaces and so forth.

This is all accomplished via the following syntax...

```
def someBuilder = new NodeBuilder()

someBuilder.people(kind:'folks', groovy:true) {
  person(x:123, name:'James', cheese:'edam') {
    project(name:'groovy')
    project(name:'geronimo')
  }
  person(x:234, name:'bob', cheese:'cheddar') {
    project(name:'groovy')
    project(name:'drools')
  }
}
```

Whichever kind of builder object is used, the syntax is the same. What the above means is that the someBuilder object has a method called 'people' invoked with 2 parameters...

- a Map of arguments ['kind':'folks', 'groovy':true]
- a Closure object which when invoked will call 2 methods on the builder called 'person', each taking 2 parameters, a map of values and a closure...

So we can easily represent any arbitrary nested markup with ease using a simple concise syntax. No pointy brackets! 😊

What's more is this is native Groovy syntax; so you can mix and match this markup syntax with any other Groovy features (iteration, branching, method calls, variables, expressions etc). e.g.

```
// lets create a form with a label & text field for each property of a bean
def swing = new SwingBuilder()
def widget = swing.frame(title:'My Frame',
  defaultCloseOperation: javax.swing.WindowConstants.EXIT_ON_CLOSE) {
  panel() {
    for (entry in someBean) {
      label(text:entry.key)
      textField(text:entry.value)
    }
    button(text:'OK', actionPerformed:{ println("I've been clicked with event ${it}") })
  }
}
widget.show()
```

Trees, DOMs, beans and event processing

The really neat thing about GroovyMarkup is that its just a syntax which maps down to method calls. So it can easily support the building of any arbitrary object structure - so it can build any DOMish model, a bean structure, JMX MBeans, PicoComponents, Swing front ends, Ant tasks etc. What's more since its just normal method invocations it can naturally map to SAX event processing too.

Out of the box Groovy comes with a few different markup builders you can use :

- NodeBuilder - creates a tree of Node instances which can be easily navigated in Groovy using an XPath-like syntax
- DOMBuilder - creates a W3C DOM document from the markup its given
- SAXBuilder - fires SAX events into a given SAX ContentHandler
- MarkupBuilder - outputs XML / HTML markup to some PrintWriter for things like implementing servlets or code generation

- AntBuilder - fires off Ant tasks using familiar markup for processing build tasks
- SwingBuilder - creates rich Swing user interfaces using a simple markup

Examples

Here's a simple example which shows how you could iterate through some SQL result set and output a dynamic XML document containing the results in a custom format using GroovyMarkup

```
// lets output some XML builder (could be SAX / DOM / TrAX / text)
def xml = new NodeBuilder()
xml.customers() {
  loc = 'London'
  sql.eachRow("select * from customer where location = ${loc}") {

    // lets process each row by emitting some markup
    xml.customer(id:it.id, type:'Customer', foo:someVariable) {
      role(it.person_role)
      name(it.customer_name)
      location(id:it.location_id, name:it.location_name)
    }
  }
}
```

The interesting thing about the above is that the XML technology used at the other end could be push-event based (SAX) or pull-event based (StAX) or a DOM-ish API (W3C, dom4j, JDOM, EXML, XOM) or some JAXB-ish thing (XMLBeans, Castor) or just beans or just good old text files. e.g. a pull parser could literally pull the data out of the database - or the data could be pushed into data some structure or piped straight to a file using IO or async NIO.

The use of GroovyMarkup means developers can hide the XML plumbing and focus on tackling the real problems we're trying to solve.

To see more examples of using GroovyMarkup try looking at our unit test cases

- [XML unit tests](#)
- [Ant unit tests](#)
- [Swing demos](#)

There is more detail on markup here [Make a builder](#).

For those new to both Java and Groovy

This page last changed on Aug 30, 2007 by [gavingrover](#).

Java developers benefit from using Groovy, but so can you who **don't already know Java**. If you want to access the power of the Java Virtual Machine and Development Kit libraries when programming, but don't want to learn the Java Language, you can **use Groovy instead**. Or maybe you do want to learn Java, but do so the easy way: you can **learn Groovy first**. You'll be productive sooner, and can go on to learn more about Java at your own pace.

Much of the documentation on this website at Codehaus is for those who already know Java. These pages are for you who don't, so you can **learn enough of the Groovy basics** to easily use the other documentation on this website. They introduce **Groovy's core classes and syntax** together. All code examples have been tested using Groovy 1.0 or later inside a script. It's aimed at **you who have already programmed before**, just not in Java, maybe in PHP, Perl, or Visual Basic. Do note that although this documentation is correct and detailed, it's still a little raw because it's still being written.

[Getting Started](#) - enough background to dive into the tutorials that follow

1. Numeric Processing

[Integer Math](#) - choose from many types of integers

[Decimal Math](#) - for high-precision decimal math

[Floating Point Math](#) - for high-speed decimal math

[Dates and Times](#) - enabling complex date manipulations

2. Collections

[Lists and Sets](#) - group various items into a collection

[Arrays](#) - fixed-size arrays for faster collections

[Maps](#) - assign collected values to keys

3. Text Processing

[Characters](#) - access the full power of Unicode

[Strings](#) - easily handle strings of characters

[String Pattern Matching](#) - find patterns within strings

4. Input and Output

[Files](#) - manipulate the file system easily

[Streams, Readers, and Writers](#) - access data as a flow of information

5. Control Structures

[Blocks, Closures, and Functions](#) - compose programs from many building blocks

[Expandos, Classes, and Categories](#) - encapsulate program complexity

[Program Control](#) - various ways to structure program logic

6. Data Typing

[Static Typing and Interfaces](#) - put compile-time restrictions in programs

[Inheritance](#) - use classes and methods for many purposes

[Exceptions](#) - handle exception and error conditions simply

7. Meta-Programming

[Interceptors](#) - intercept method calls

[MetaClasses](#) - add and modify behavior of objects

[Class Reflection](#) - examine and manipulate objects dynamically - **IN PROGRESS**

Other Topics Coming

Packages
Multi-Threading
Networking
Internationalization
Annotations
Enums
Builders
Class Loading
Permissions

To continue learning Groovy, you can now go on to:

[Java](#), the engine behind Groovy's power and performance

[Swing](#), the graphical interface for Java, made easy with Groovy's own [SwingBuilder](#)

[Eclipse](#), the free IDE with a [Groovy plugin](#) to make managing your code easy

[useful Groovy modules](#), such as [Gant](#), which extend the Groovy system

[Grails](#), bringing the power of Groovy to website development and deployment

JN0025-Starting

This page last changed on Aug 30, 2007 by [gavingrover](#).

The Groovy Programming Language runs on top of the Java Runtime Environment, which itself runs on almost any computer system, such as Windows, Linux, and Macintosh. If you don't have Groovy installed, see these pages:

[Installing Groovy](#)

[Running Groovy](#)

If you don't have the Java Runtime Environment:

[Installing Java](#)

These tutorials for those new to both Java and Groovy are in a sequence that builds on knowledge already presented. This tutorial therefore starts with the basics. Throughout, we use code examples rather than lengthy explanations to present the features of Groovy, so you might miss things if you just skim. We don't (yet) explain what you would use the features for, but rely on your previous programming background for this.

The code snippets in these tutorials use comments to explain things:

```
//comment like this to end of line, ignoring /* and /* and ' and "  
/*or comment like this, ignoring // and ' and " until: */  
/*or comment over  
many lines, /*with no nesting*/
```

Groovy code can contain strings:

```
'A string can be within single quotes on one line...'  
'''...or within triple single quotes  
over many lines, ignoring // and /* and /* comment delimiters,...'''  
"...or within double quotes..."  
"""...or within triple double quotes  
over many lines.""
```

Each line here does the same:

```
println 'hello, world' //the function 'println' prints a string then newline  
print 'hello, world\n' //'print' doesn't print newline, but we can embed  
//newlines ('\n' on Unix/Linux, '\r\n' on Windows)  
println 'hello' + ', ' + 'world' // + joins strings together  
print 'hello, '; println 'world'  
//use semi-colons to join two statements on one line  
println( 'hello, world' )  
//can put command parameter in parens, sometimes we might have to  
def a= 'world'; println 'hello, ' + a  
//'def' to define a variable and give it a value  
print 'hello, world'; println()  
//empty parens must be used for no-arg functions; here, prints a blank line  
def b= 'hello', c= 'world'; println "$b, ${c}"  
//$ in print string captures variable's value
```

We can also assign integers and decimals to variables:

```
def g = 7, groovy = 10.2  
//we can separate more than one defined variable by a comma  
print g + ', ' + groovy + '\n' //prints: 7, 10.2  
assert g + ', ' + groovy == '7, 10.2' //we can use assert statement and ==  
//operator to understand examples
```

We can use operators like + - * / and parentheses () with numbers, following usual math grouping rules:

```
assert 4 * ( 2 + 3 ) - 6 == 14 //integers only  
assert 2.5 + 7 == 9.5  
assert 7 / 4 == 1.75 //decimal number or division converts expression to decimal
```

We can use the operators == > < >= <= != with numbers, the values true and false, the operators ! (not), && (and), and || (or), all with parentheses, to produce boolean expressions:

```

assert 2 > 3 == false
assert 7 <= 9
assert 7 != 2
assert true
assert ! false
assert 2 > 3 || 7 <= 9
assert ( 2 > 3 || 4 < 5 ) && 6 != 7

```

Variables are versatile:

```

def a
assert a == null
//variables defined but not given a value have special value null
def b = 1
assert b == 1
b = 2
assert b == 2 //variables can be re-assigned to
b = 'cat'
assert b == 'cat' //they can be re-assigned different types/classes of data
b = null
assert b == null //they can be unassigned

```

All names in Groovy, including variable names, can contain any alphabetic character or the underscore, and contain any digit not in first position:

```

def abc= 4
def a23c= 4
def ab_c= 4
def _abc= 4

def ABC= 4
assert abc == ABC //although their values are the same...
assert ! abc.is( ABC ) //...the variables 'abc' and 'ABC' are different,
//the names being case-sensitive

/*these each produce compile errors when uncommented...
def abc //already defined
def a%c= 4 //not a valid name because it contains a symbol other than _
def 2bc= 4 //may not contain a digit in first position
*/

```

All data in Groovy is built from "classes" and instances of them. Class names by convention begin with an uppercase character:

```

assert Byte.MAX_VALUE == 127
//a class can have attached variables, called 'fields'
assert Byte.parseByte('34') == 34
//a class can have attached functions, called 'methods'
def b= new Byte('34')
//we can create an 'instance' of a class using the 'new' keyword
assert b.intValue() == 34
//each instance can also have attached fields and methods

```

We can inspect the class of any entity, such as numbers and strings, using the class field:

```

assert 4.class == Integer //the common types have both a short name...
assert 4.class == java.lang.Integer //...and a long name
assert 4.5.class == BigDecimal
assert 'hello, world'.class == String
def a= 7
assert a.class == Integer

```

There are many predefined classes in Groovy, but only the most common ones are always visible to Groovy code. Most need to be qualified with a "package" name, eg, 'java.text.DecimalFormat', or the package must be imported beforehand:

```

import java.text.*

```

```
assert new DecimalFormat( '#,#00.0#' ).format( 5.6789 ) == '05.68'
```

Or:

```
assert new java.text.DecimalFormat( '#,#00.0#' ).format( 5.6789 ) == '05.68'
```

If a line can be interpreted as a valid statement, it will be:

```
def i=
1 //because 'def i=' isn't a valid statement,
//the '1' is appended to the previous line

//a compile error when uncommented: 'def j' is valid, so is interpreted as
//a statement. Then the invalid '= 1' causes the error...
/*
def j
= 1
*/

def k \
= 1 //a backslash ensures a line is never interpreted as a standalone statement
```

Sometimes code in a script doesn't compile: we comment it out in our examples. Other code compiles but generates a "checked exception" which we can catch and handle:

```
try{
'moo'.toLong() //this will generate an exception
assert false
//this code should never be reached, so will always fail if executed
}catch(e){ assert e instanceof NumberFormatException }
//we can check the exception type using 'instanceof'
```

We can use square brackets [] to represent both ordered lists and key mappings:

```
def list= [1, 2, 3]
list= [] //empty list
list= [1, 'b', false, 4.5 ] //mixed types of values OK
assert list[0] == 1 && list[1] == 'b' && ! list[2] && list[3] == 4.5
//we can refer to items individually by index

def map= [1:'a', 2:'b', 3:'c'] //map indicated with colon :
map= [:] //empty map
map= ['a': 1, 'b': 'c', 'groovy': 78.9, 12: true] //mixed types of values
assert map['a'] == 1 && map['b'] == 'c' && map['groovy'] == 78.9 && map[12]
//we can refer to values individually by key

'each' tells the code following it to execute for each item in a list or map:
//for every item in list, assign to 'it' and execute the following code...
[ 2, -17, +987, 0 ].each{
println it
}
//we can specify a different name for the argument other than the default...
[ 2, -17, +987, 0 ].each{ n ->
println n
}
//we can specify two or more arguments, as with this map...
[ 1: 3, 2: 6, 3: 9, 4: 12 ].each{ k, v->
assert k * 3 == v
}
}
```

We can specify a list as a 'range', ie, by only the first and last items:

```
( 3..7 ).each{ println it } //prints numbers 3, 4, 5, 6, and 7
( 3..<7 ).each{ println it } //prints numbers 3, 4, 5, and 6 //excludes 7
```

We can convert data of one type to another using the 'as' keyword:

```
assert ('a' as Integer) == 97
```

```
//Unicode (and ASCII) representation of character 'a'
```

Sometimes, we need to use a more efficient type of list known as an array, where the type of each element must be the same. Arrays can't be represented directly in the syntax, but we can convert a list to one easily:

```
def x= ['a', 'b', 'c'] as Integer[] //convert each item in list to an Integer
assert x[0] == 97 && x[1] == 98 && x[2] == 99 //access each element individually
```

We can choose between two execution options using the if-else-statement:

```
def a= 2
if( a < 5 ){
println "a, being $a, is less than 5."
}else{
assert false //this line should never execute
}
```

We can execute some code a certain number of times:

```
def i=0
10.times{ println i++ } //increment i by 1 after printing it

//another less declarative style of looping...
while( i > 0 ){
println i-- //decrement i by after printing it
}
```

We can enclose code in parentheses and execute it later. The enclosed code is called a "closable block" or "closure":

```
def c= { def a= 5, b= 9; a * b }
assert c() == 45

[ { def a= 'ab'; a + 'bc' },
{ 'abbc' },
].each{ assert it() == 'abbc' }
```

We can spawn new threads from our main thread:

```
def i=0, j=0
def f= new File('TheOutput.txt') //create or overwrite this file
Thread.start{
while(true){
i++
if(i%1000 == 0) f<< 'S' //spawned thread
}
}
while(true){
j++
if(j%1000 == 0) f<< 'M' //main thread
}
```

After, say, 5 seconds, abort the program then look at the file. On many computers, it'll show a roughly equal distribution of 'S' and 'M', but there'll be some irregularities showing that thread scheduling isn't perfectly timed.

The tutorials following are grouped into functional areas, beginning with numeric processing, and build up to the advanced features of Groovy.

JN0515-Integers

This page last changed on Aug 30, 2007 by [gavingrover](#).

Groovy numbers are either decimals or integers. The 3 main types of integers are Integer, Long, and BigInteger. BigInteger has no size limit, while Integer and Long do. We can enquire their minimum and maximum values:

```
assert Integer.MAX_VALUE == 2147483647 //at 2 billion, big enough for most uses
assert Integer.MIN_VALUE == -2147483648
assert Long.MAX_VALUE == 9223372036854775807
assert Long.MIN_VALUE == -9223372036854775808
```

Integers will normally be the smallest type into which the value will fit (using 2's-complement representation):

```
assert 110.class == Integer
assert 3000000000.class == Long //value too large for an Integer
assert 10000000000000000000.class == BigInteger //value too large for a Long
```

We can represent integers in base-10, hexadecimal, or octal notation:

```
//base-10 integers, positive or negative...
[ 2, -17, +987 ].each{ assert it }

//hex using leading 0x (lowercase or uppercase for a,b,c,d,e,f,x)...
[ 0xAcE, 0X01ff ].each{ assert it }

//octal using leading 0...
[ 077, 01 ].each{ assert it }
```

We can negate hexadecimal and octals to represent negative numbers.

```
assert 0x7FFFFFFF.class == Integer
assert (-0x7FFFFFFF).class == Integer //we must negate using the minus sign
assert 0x80000000.class == Long
assert (-0x80000000).class == Integer
assert (-0x80000001).class == Long
```

We can force an integer (including hexadecimal and octals) to have a specific type by giving a suffix (I for Integer, L for Long, G for BigInteger), either uppercase or lowercase:

```
assert 42i.class == Integer //lowercase i more readable
assert 123L.class == Long //uppercase L more readable
assert 456g.class == BigInteger
assert 0xFFi.class == Integer
```

Fixed-Size Integers

The fixed-size integers, Integer and Long, each have size limits but are more efficient in calculations.

There are also the less common Byte and Short types of integer, which act like the Integer type in math operations.

```
assert Short.MAX_VALUE == 32767
assert Short.MIN_VALUE == -32768
assert Byte.MAX_VALUE == 127
assert Byte.MIN_VALUE == -128
def a= new Byte('34'), b= new Byte('2')
assert (a+b).class == Integer
```

We can enquire the bit-size of each type of fixed-size integer:

```
assert Integer.SIZE == 32
assert Long.SIZE == 64
assert Short.SIZE == 16
```

```
assert Byte.SIZE == 8
```

The class Integer can often be written int. The classes Long, Short, and Byte can each also often be written uncapitalized, ie, long, short, and byte. We can enquire these alternative (aka "primitive type") names:

```
assert Integer.TYPE == int
assert Long.TYPE == long
assert Short.TYPE == short
assert Byte.TYPE == byte
```

The fixed-size integer classes can be converted to one another:

```
assert 45L as Integer == 45i
assert 45L as int == 45i //example of using 'int' for Integer
assert 45L.toInteger() == 45i //alternative syntax
assert 23L.intValue() == 23i //another alternative syntax

assert 45i as Long == 45L
assert 45i as long == 45L
assert 23i.toLong() == 23L
assert 45i.longValue() == 45L

//if converted number too large for target, only lowest order bits returned...
assert 256i as Byte == 0
assert 200i as byte == -56 //...and this may result in a negative number
```

We can create new fixed-sized integers from strings:

```
assert '42'.toInteger() == 42i
assert '56'.toLong() == 56L

try{ 'moo'.toLong(); assert false }
catch(e){ assert e instanceof NumberFormatException }

assert new Integer( '45' ) == 45i
assert new Byte( '45' ) == 45 as byte

try{ new Integer( 'oink' ); assert false }
catch(e){ assert e instanceof NumberFormatException }
```

To convert from a fixed-size integer to a string in various bases:

```
//second character is the base/radix...
assert Integer.toString( 29, 16 ) == '1d'

//Long version behaves just like Integer version...
assert Long.toString( 29L, 16 ) == '1d'

//if number is negative, so is first character of returned string...
assert Integer.toString( -29, 16 ) == '-1d'

//only time result begins with zero is if it is zero...
assert Integer.toString(0) == '0'

assert Integer.toString( 29, 16 ).toUpperCase() == '1D'

//second argument defaults to 10...
assert Integer.toString( 29 ) == '29'

//Short version only accepts one parameter, only allowing base 10...
assert Short.toString( 29 as short ) == '29'
```

If the base/radix isn't between Character.MIN_RADIX and Character.MAX_RADIX, base 10 is used instead:

```
assert Integer.toString( 999, Character.MIN_RADIX - 1 ) ==
Integer.toString( 999, 10 )
```



```
assert Integer.toString( 999, Character.MAX_RADIX + 1 ) ==
Integer.toString( 999, 10 )
```

```
assert Character.MAX_RADIX == 36
//the symbols letters 0123456789abcdefghijklmnopqrstuvwxy are used
```

The common bases have similar methods which always return an unsigned integer:

```
assert Integer.toHexString(29) == '1d' //return unsigned base-16 integer
assert Integer.toHexString(0) == '0'
assert Integer.toHexString(-17) == 'fffffffef'
assert Long.toHexString(-17L) == 'fffffffffffffffef'
```

```
//same as toString(,16) when number positive...
assert Integer.toHexString(29) == Integer.toString(29,16)
```

```
//...but different when number negative
assert Integer.toHexString(-17) != Integer.toString(-17,16)
```

```
assert Integer.toOctalString(29) == '35'
assert Integer.toOctalString(0) == '0'
assert Integer.toOctalString(-17) == '3777777757'
assert Integer.toBinaryString(29) == '11101'
```

We can convert a string representation to an integer, using a specified base/radix:

```
assert Integer.parseInt("0", 10) == 0
assert Integer.parseInt("473", 10) == 473
assert Long.parseLong("473", 10) == 473L //Long type has similarly-acting method
assert Integer.parseInt("473") == 473 //base 10 is the default base/radix
assert Integer.parseInt("-0", 10) == 0
assert Integer.parseInt("-FF", 16) == -255
assert Integer.parseInt("1100110", 2) == 102
assert Integer.parseInt("2147483647", 10) == 2147483647
assert Integer.parseInt("-2147483648", 10) == -2147483648
assert Integer.parseInt("Kona", 27) == 411787
assert Long.parseLong("Hazelnut", 36) == 1356099454469L
assert Short.parseShort("-FF", 16) == -255
```

A NumberFormatException may be thrown:

```
[ { Integer.parseInt("2147483648", 10) }, //number too large
{ Integer.parseInt("99", 8) }, //digit 9 not octal
{ Integer.parseInt("Kona", 10) }, //digits not decimal
{ Integer.parseInt("1111", Character.MIN_RADIX - 1 ) }, //radix too small
{ Integer.parseInt("1111", Character.MAX_RADIX + 1 ) }, //radix too large
{ Integer.parseInt( '@#$$%' ) }, //invalid number
{ Integer.parseInt( ' ' ) }, //invalid number
].each{ c->
try{ c(); assert false }
catch(e){assert e instanceof NumberFormatException}
}
```

An alternative method name is:

```
assert Integer.valueOf( '12af', 16 ) == 0x12af
//same as: Integer.parseInt( '12af', 16 )
```

```
assert Long.valueOf( '123' ) == 123
//same as: Long.parseInt( '123' )
```

```
assert Short.valueOf( 027 as short ) == 027
```

We can convert a string to a fixed-size integer, similar to parseInt() etc, but with the radix instead indicated inside the string:

```

assert Integer.decode('0xff') == 0xFF
assert Integer.decode('#FF') == 0xFF
assert Long.decode('#FF') == 0xFFL //long, short, and byte also can be decoded
assert Short.decode('#FF') == 0xFF as short
assert Byte.decode('#F') == 0xF as byte
assert Integer.decode('-077') == -077
assert Integer.decode('2345') == 2345

try{ Integer.decode('7 @8'); assert false }
catch(e){ assert e instanceof NumberFormatException }

```

We can return an integer representing the sign:

```

assert Integer.signum(45i) == 1
assert Integer.signum(0i) == 0
assert Integer.signum(-43i) == -1
assert Long.signum(-43L) == -1

```

We can compare fixed-size integers with each other:

```

assert 45i.compareTo( 47L ) < 0
assert (45 as byte).compareTo( 43 as short ) > 0
assert 45.compareTo( 45 ) == 0

```

Calculations with Fixed-Size Integers

We can perform addition, subtraction, multiplication, exponents, modulus, and negations on Integers and Longs, using both an operator syntax and a method syntax:

```

assert 34 + 33 == 67    && 34.plus( 33 ) == 67
assert 34L - 21L == 13L && 34L.minus( 21L ) == 13L
assert 3 * 31 == 93    && 3.multiply( 31 ) == 93
assert 23 % 3 == 2     && 23.mod( 3 ) == 2
assert 3**2 == 9       && 3.power( 2 ) == 9

```

Not all calculations have a special operator symbol:

```

assert 22.intdiv(5) == 4
assert (-22).intdiv(5) == -4
assert (-34).abs() == 34
assert (-34L).abs() == 34L

```

We can increment and decrement variables, using operators, either before and after evaluation:

```

def a = 7
assert a++ == 7 && a == 8 && a-- == 8 && a == 7 &&
++a == 8 && a == 8 && --a == 7 && a == 7

def b = 7, c = 7 //These operators use methods next() and previous()
assert ( ++b ) == ( c = c.next() )
assert b == c
assert ( --b ) == ( c = c.previous() )
assert b == c
assert ( b++ ) == { def z = c; c = c.next(); z }()
assert b == c

def b = Integer.MAX_VALUE
assert ++b == Integer.MIN_VALUE && --b == Integer.MAX_VALUE

```

Rules of parentheses and precedence apply to these operators. The operators have the same precedence irrespective of what type of values they operate on.

```

assert 3*(4+5) != 3*4+5 //parenthesized expressions always have highest precedence

assert -3**2 == -(3**2) //power has next highest precedence
assert ( 2*3**2 == 2*(3**2) ) && ( 2*3**2 != (2*3)**2 )

```

```

assert -3+2 != -(3+2) //unary operators have next highest precedence
assert ~234 == ~(234) //unary operators group right-to-left

//multiplication and modulo have next highest precedence
assert 3*4%5 == (3*4)%5 //multiplication and modulo have equal precedence
assert 3%4*5 == (3%4)*5

//addition and subtraction have equal precedence, lower than mult/etc
assert 4+5-6 == 3
assert 5+3*4 == 5+(3*4)

```

Integers often convert their types during math operations. For + - *, a Long with an Integer converts the Integer to a Long:

```
assert (23i+45L).class == Long
```

Because the fixed-sized integers have fixed width, they might overflow their boundaries during math operations, so we need to be aware of the range of values we'll use a fixed-size integer for:

```

//each 256 is an int, so final product also an int, and calc overflowed...
assert 256*256*256*256 == 0

//we can fix this problem by using a long at the beginning of the calculation...
assert 256L*256*256*256 == 4294967296L

```

We can compare fixed-size integers using < <= > >= operators, of lower precedence than addition/etc:

```

assert 14 > 7          && 14.compareTo(7) > 0
assert 14 >= 8         && 14.compareTo(8) >= 0
assert -4 < 3          && (-4).compareTo(3) < 0
assert -14 <= -9       && (-14).compareTo(-9) <= 0

```

The operators == != <=> are of lower precedence than the other comparison operators:

```

def a = 4, b = 4, c = 5
assert a == b && a.equals(b)
assert a != c && ! a.equals(c)
assert (4 <=> 7) == -1 && 4.compareTo(7) == -1
assert (4 <=> 4) == 0 && 4.compareTo(4) == 0
assert (4 <=> 2) == 1 && 4.compareTo(2) == 1

```

Bit-Manipulation on Fixed-Sized Integers

We can examine and manipulate the individual bits on the fixed-sized integers.

To return an int or long with a single 1-bit in the position of the highest-order 1-bit in the argument:

```

assert Integer.highestOneBit( 45 ) == 32
assert Integer.highestOneBit( 27 ) == 16
assert Integer.highestOneBit( 0 ) == 0
assert Integer.highestOneBit( -1 ) == -128*256*256*256
assert Long.highestOneBit( -1L ) == -128*256*256*256 * 256*256*256*256

assert Integer.lowestOneBit( 45i ) == 1 //match lowest order 1-bit in argument
assert Integer.lowestOneBit( 46i ) == 2
assert Integer.lowestOneBit( 48i ) == 16

```

To return the number of zero bits preceding the highest-order 1-bit:

```

[ 0:32, 1:31, 2:30, 4:29 ].each{ k, v->
assert Integer.numberOfLeadingZeros( k ) == v
//returns the number of zero-bits preceding the highest-order 1-bit
assert Long.numberOfLeadingZeros( k as long ) == v + 32
}

[ 0:32, 45:0, 46:1, 48:4 ].each{ k, v->
assert Integer.numberOfTrailingZeros( k ) == v

```

```
//returns the number of 0-bits following the lowest-order 1-bit
}
```

```
//returns the number of 1-bits in the binary representation...
assert Integer.bitCount( 7 ) == 3
assert Integer.bitCount( -1 ) == 32
```

We can perform a bitwise complement of the bits in a fixed-size integer using the `~` operator:

```
def x= 0x33333333i
assert ~x == -x - 1
//how bitwise complement and negation are related under 2's-complement
```

We can shift the bits of a fixed-size integer to the left or right. This is of lower precedence than addition/ etc, but higher than the comparison operators.

```
//shift 4 bits to the left...
assert 0xB4F<<4 == 0xB4F0      && 0xB4F.leftShift( 4 ) == 0xB4F0

//shift 4 bits to the right, dropping off digits...
assert 0xD23C>>4 == 0xD23      && 0xD23C.rightShift( 4 ) == 0xD23

//sign-extension performed when right-shifting...
assert -0xFFF>>4 == -0x100     && (-0xFFF).rightShift( 4 ) == -0x100

//...unless triple >>> used
assert -0xFFF>>>4 == 0xFFFFF00 && (-0xFFF).rightShiftUnsigned(4) == 0xFFFFF00
[ 0xABC, -0x98765 ].each{
it << 8  == it >> -8
}
```

We can rotate the bits in an integer or long:

```
assert Integer.rotateLeft( 0x456789AB, 4 ) == 0x56789AB4
//we use multiples of 4 only to show what's happening easier

assert Integer.rotateLeft( 0x456789AB, 12 ) ==
Integer.rotateRight( 0x456789AB, Integer.SIZE - 12 )
//rotating left and right are inverse operations

assert Integer.rotateLeft( 0x456789AB, 32 ) == 0x456789AB //no change here

assert Long.rotateRight( 0x0123456789ABCDEF, 40 ) == 0x6789ABCDEF012345
```

We can perform bitwise 'and', 'or', and 'xor' operations on fixed-size integers. This is of lower precedence than the comparison operators.

```
assert (0x33 & 0x11) == 0x11 && 0x33.and(0x11) == 0x11
assert (0x33 | 0x11) == 0x33 && 0x33.or(0x11) == 0x33
assert (0x33 ^ 0x11) == 0x22 && 0x33.xor(0x11) == 0x22
```

We can reverse the bits or bytes of the binary representation of an int or long:

```
assert Integer.toString( 123456, 2 ) == '11110001001000000'

assert Integer.toString( Integer.reverse( 123456 ), 2 ) ==
'1001000111110000000000000000' //reverse bits

assert Integer.reverseBytes( 0x157ACE42 ) == 0x42CE7A15 //also works for bytes
```

Boolean, Conditional, and Assignment Operators with Fixed-Sized Integers

The boolean, conditional, and assignment operators are of even lower precedence than the bitwise operators.

When using an integer with boolean operators `!`, `&&`, and `||`, `0` evaluates to false, while every other integer evaluates to true:

```

assert ! 0; assert 1; assert 2; assert -1; assert -2
assert ( ! 1 && 0 ) != ( ! (1 && 0) )
// the unary ! has the same, high, precedence as the other unary operators
assert ( 1 || 0 && 0 ) != ( (1 || 0) && 0 ) // && has higher precedence than ||

```

The boolean operators && and || only have their operands evaluated until the final result is known. This affects operands with side effects, such as increment or decrement operators:

```

def x = 0
0 && x++
assert x == 0
//x++ wasn't performed because falsity of (0 && x++) was known when 0 evaluated

1 || x++
assert x == 0
//x++ wasn't performed because truth of (1 || x++) was known when 1 evaluated

```

We can use the conditional operator ?:, of lower precedence than the boolean operators, to choose between two values:

```

def x= 1? 7: -5
assert x == 7

```

We can put the assignment operator = within expressions, but must surround it with parentheses because its precedence is lower than the conditional:

```

def x, y = (x = 3) && 1
assert (x == 3) && y

def i = 2, j = (i=3) * i
//in the multiplication, lefthand (i=3) evaluated before righthand i
assert j == 9

```

Of equal precedence as the plain assignment operator = are the quick assignment *= += -= %= **= <<= >>= >>>= &= ^= |= operators:

```

def a = 7
a += 2 //short for a = a + 2
assert a == 9
a += (a = 3) //expands to a = a + (a = 3) before any part is evaluated
assert a == 12

```

BigIntegers

The BigInteger has arbitrary precision, growing as large as necessary to accommodate the results of an operation.

We can explicitly convert fixed-sized integers to a BigInteger, and vice versa:

```

assert 45i as BigInteger == 45g
assert 45L.toBigInteger() == 45g
assert 45g as Integer == 45i
assert 45g.intValue() == 45i //alternate syntax
assert 45g as Long == 45L
assert 45g.longValue() == 45L

assert 256g as Byte == 0
//if converted number too large for target, only lowest order bits returned
assert 200g as byte == -56 //...and this may result in a negative number

```

A method and some fields that give a little more efficiency:

```

assert BigInteger.valueOf( 45L ) == 45g
//works for longs only (not for ints, shorts, or bytes)
assert BigInteger.ZERO == 0g
assert BigInteger.ONE == 1g

```

```
assert BigInteger.TEN == 10g
```

We can construct a BigInteger using an array of bytes:

```
assert new BigInteger( [1,2,3] as byte[] ) == 1g*256*256 + 2*256 + 3
//big-endian 2's complement representation
try{new BigInteger( [] as byte[] ); assert 0}
catch(e){assert e instanceof NumberFormatException} //empty array not allowed

assert new BigInteger( -1, [1,2] as byte[] ) == -258g
//we pass in sign as a separate argument

assert new BigInteger( 1, [1,2] as byte[] ) == 258g

assert new BigInteger( 0, [0,0] as byte[] ) == 0g

assert new BigInteger( 1, [] as byte[] ) == 0 //empty array allowable

try{ new BigInteger( 2, [1,2,3] as byte[] ); assert 0 }
catch(e){ assert e instanceof NumberFormatException}
//sign value must be -1, 0, or 1
```

We can convert a BigInteger back to an array of bytes:

```
def ba= (1g*256*256 + 2*256 + 3).toByteArray()
//big-endian 2's complement representation
assert ba.size() == 3 && ba[ 0 ] == 1 && ba[ 1 ] == 2 && ba[ 2 ] == 3

def bb= 255g.toByteArray()
assert bb.size() == 2 && bb[ 0 ] == 0 && bb[ 1 ] == -1
//always includes at least one sign bit

def bc= -(2g*256 + 3).toByteArray()
assert bc.size() == 2 && bc[ 0 ] == -3 && bc[ 1 ] == -3
```

We can pass in a string in a certain base/radix:

```
assert '27'.toBigInteger() == 27g
assert new BigInteger("27", 10) == 27g
assert new BigInteger("27") == 27g //default radix is 10
assert new BigInteger("110", 2) == 6g
assert new BigInteger("-1F", 16) == -31g
[ { new BigInteger(" 27", 10) }, //no whitespace allowed in string
  { new BigInteger("Z", Character.MAX_RADIX + 1 ) }, //radix out of range
  { new BigInteger("0", Character.MIN_RADIX - 1 ) }, //radix out of range
].each{
try{ it(); assert 0 }catch(e){ assert e instanceof NumberFormatException }
}
```

We can convert the BigInteger back to a string:

```
assert 6g.toString(2) == '110'
assert (-31g).toString(16) == '-1f'
assert 27g.toString() == '27' //default radix is 10
assert 27g.toString( Character.MAX_RADIX + 1 ) == '27'
//radix is 10 if radix argument invalid
```

We can construct a randomly-generated BigInteger:

```
assert new BigInteger( 20, new Random() ).toString( 2 ).size() == 20
//20 is max bit length, must be >= 0
assert new BigInteger( 20, new Random() ) >= 0
```

Arithmetic with BigIntegers

We can perform the usual arithmetic operations + - * using either methods or operations:

```

assert 34g.plus( 33g ) == 34g + 33g
assert 34g.add( 33g ) == 34g + 33g //alternative name for plus
assert 34g.minus( 21g ) == 34g - 21g
assert 34g.subtract( 21g ) == 34g - 21g //alternative name for minus
assert 3g.multiply( 31g ) == 3g * 31g
assert 7g.negate() == -7g //unary operation/method
assert (-7g).negate() == 7g

```

For + - *, a BigInteger causes any fixed-width integers in the calculation to be converted to a BigInteger:

```

assert (45L + 123g).class == BigInteger
assert (23 - 123g).class == BigInteger
assert ( 3g * 31 ).class == BigInteger
assert ( 3 * 31g ).class == BigInteger
assert 3g.multiply( 31 ).class == BigInteger
assert 3.multiply( 31g ).class == BigInteger

```

We can introduce a BigInteger into an expression with Integers or Longs if overflow may occur. But make sure the BigInteger is introduced before an intermediate value that may overflow, for example, the first-used value in a calculation:

```

assert 256L*256*256*256 * 256*256*256*256 == 0
//the first 256 is a Long, so each intermediate and final product also Long,
//and calc overflowed

assert 256g*256*256*256 * 256*256*256*256 == 18446744073709551616
//no overflow here because BigInteger introduced in first value

```

We can also increment and decrement BigIntegers:

```

def a= 7g
assert a++ == 7g && a == 8g && a-- == 8g && a == 7g &&
++a == 8g && a == 8g && --a == 7g && a == 7g

```

We can find out the quotient and remainder:

```

assert 7g.divide( 4g ) == 1g
assert 7g.remainder( 4g ) == 3g
def a= 7g.divideAndRemainder( 4g )
assert a[0] == 1g //quotient, same result as divide()
assert a[1] == 3g //remainder, same result as remainder()

assert 7g.divide( -4g ) == -1g
assert 7g.remainder( -4g ) == 3g
assert (-7g).divide( 4g ) == -1g
assert (-7g).remainder( 4g ) == -3g
//division of a negative yields a negative (or zero) remainder
assert (-7g).divide( -4g ) == 1g
assert (-7g).remainder( -4g ) == -3g

```

Other methods for arithmetic:

```

assert 22g.intdiv(5g) == 4g
assert (-22g).intdiv(5g) == -4g

assert 7g.abs() == 7g //absolute value
assert (-7g).abs() == 7g

assert 28g.gcd(35g) == 7g
//greatest common divisor of absolute value of each number

assert (-28g).gcd(35g) == 7g
assert 28g.gcd(-35g) == 7g
assert (-28g).gcd(-35g) == 7g
assert 0g.gcd(9g) == 9g
assert 0g.gcd(0g) == 0g

```

```

assert 4g**3 == 64g //raising to the power
assert (4g**3).class == Integer
//raising to the power converts a BigInteger to an integer

assert 4g.power(3) == 64g //using method
assert 4g.pow(3) == 64g
//pow() is different to, and sometimes slower than, power()
assert (-4g).power(3) == -64g
assert 4g.power(0) == 1g //exponent must be integer >=0

assert 7g % 4g == 3g && 7g.mod( 4g ) == 3g
//modulo arithmetic, using operator or method
assert 8g % 4g == 0g
assert -7g % 4g == 1g
//result of mod is between 0 and (modulus - 1) inclusive
try{ 7g % -4g; assert 0 }catch(e){ assert e instanceof ArithmeticException }
//mod value must be positive

assert 4g.modPow( 3g, 9g ) == 1
//calculates as ((4**3) mod 9), result always zero or positive
assert 4g.modPow( -2g, 9g ) == 4
//negative exponents allowed, but mod value must be positive

assert 4g.modInverse( 3g ) == 1 //calculates as ((4**-1) mod 3)
//mod must be positive, and value must have a multiplicative inverse mod m
//(ie, be relatively prime to m)

assert 7g.max(5g) == 7g //maximum and minimum
assert 4g.min(5g) == 4g
def a=5g, b=5g, c=a.min(b)
assert [a,b].any{ c.is(it) }
//either a or b may be returned if they're both equal

assert (-45g <=> -43g) && ( (-45g).compareTo( -43g ) == -1 )
//comparing two BigIntegers
assert 14g >= 8g && 14g.compareTo(8g) >= 0

assert 45g.signum() == 1 //return sign as -1,0, or 1
assert 0g.signum() == 0
assert (-43g).signum() == -1

```

We can construct a randomly generated positive BigInteger with a specified bit length (at least 2 bits), that is probably prime to a specific certainty. The probability the BigInteger is prime is $>(1 - (1/2)^{\text{certainty}})$. If the certainty ≤ 0 , true always returned. The execution time is proportional to the value of this parameter. We must pass in a new Random object:

```

100.times{
def primes= [17g, 19g, 23g, 29g, 31g]
//bitlength is 5, so primes from 16 to 31 incl
assert new BigInteger( 5, 50, new Random() ) in primes
//5 is bit-length, 50 is certainty (must be integer)
}

def pp= BigInteger.probablePrime( 20, new Random() )
//if we don't want to specify certainty
//20 is bit-length; there's <1.0e-30 chance the number isn't prime

def pn= pp.nextProbablePrime()
//this is probably next prime, but definitely no primes skipped over
( (pp+1)..<pn ).each{
assert ! it.isProbablePrime(50)
//we can test for primality to specific certainty (here, 50).
//True if probably prime, false if definitely composite
}
assert 10g.nextProbablePrime() == 11
assert 0g.nextProbablePrime() == 2

```

Bit-Manipulation on BigIntegers

All operations behave as if `BigIntegers` were represented in two's-complement notation. Bit operations operate on a single bit of the two's-complement representation of their operand/s. The infinite word size ensures that there are infinitely many virtual sign bits preceding each `BigInteger`. None of the single-bit operations can produce a `BigInteger` with a different sign from the `BigInteger` being operated on, as they affect only a single bit.

```
assert 0x33g.testBit(1)
//true if bit is 1, indexing beginning at 0 from righthand side
assert ! 0x33g.testBit(2)
(2..100).each{
assert (-0x3g).testBit(it)
//negative BigIntegers have virtual infinite sign-extension
}
```

Unlike with fixed-width integers, `BigIntegers` don't have a method to show the hex, octal, or binary representation of a negative number. We can use this code instead to look at the first 16 lowest-order virtual bits:

```
def binRepr={n->
(15..0).inject(''){flo,it->
flo<< (n.testBit(it)? 1: 0)
}
}
assert 0x33g.toString(2) == '110011'
assert binRepr(0x33g) as String == '0000000000110011'
assert (-0x33g).toString(2) == '-110011' //not what we want to see
assert binRepr(-0x33g) as String == '1111111111001101'
//notice the negative sign bit extended virtually
```

More bit-manip methods:

```
assert 0x33g.setBit(6) == 0x73g //0x33g is binary 110011
assert 0x33g.clearBit(4) == 0x23g
assert 0x33g.flipBit(1) == 0x31g
assert 0x33g.flipBit(2) == 0x37g

assert 0x1g.getLowestSetBit() == 0
//index of the rightmost one bit in this BigInteger
assert 0x2g.getLowestSetBit() == 1
assert 0x8g.getLowestSetBit() == 3
assert 0x33g.bitLength() == 6
//number of bits in minimal representation of number
assert (-0x33g).bitLength() == 6 //exclude sign bit
assert 0x33g.bitCount() == 4 //number of bits that differ from sign bit
assert (-0x33g).bitCount() == 3
```

Setting, clearing, or flipping bit in virtual sign makes that bit part of the number:

```
assert (-0x33g).clearBit(9) == -0x233g
```

We can perform bit-shifting on `BigIntegers`. The shortcut operators `>>` and `<<` can't be used, only the method names can be (they're also spelt differently to the fixed-size integer versions of the names, eg, "shiftLeft" instead of "leftShift"). There's no shift-right-unsigned method because this doesn't make sense for `BigIntegers` with virtual infinite-length sign bits.

```
assert 0xB4Fg.shiftLeft( 4 ) == 0xB4F0g //shift 4 bits to the left
assert 0xD23Cg.shiftRight( 4 ) == 0xD23g
//shift 4 bits to the right, dropping off digits
assert (-0xFFFg).shiftRight( 4 ) == -0x100g
//sign-extension performed when right-shifting
[ 0xABCg, -0x98765g ].each{
it.shiftLeft( 8 ) == it.shiftRight( -8 )
}
```

We can perform 'not', 'and', 'or', and 'xor' bitwise operations on BigIntegers:

```
assert 123g.not() == -124g //in 2's-complement, negate and add 1
assert -0xFFg.not() == 0x100g

assert ( (0x33g & 0x11g) == 0x11g)  && 0x33g.and(0x11g) == 0x11g
assert ( (0x33g | 0x11g) == 0x33g)  && 0x33g.or(0x11g) == 0x33g
assert ( (0x33g ^ 0x11g) == 0x22g)  && 0x33g.xor(0x11g) == 0x22g
assert 0x33g.andNot(0x11g) == 0x22g && (0x33g & (~ 0x11g)) == 0x22g
//convenience operation
```

For negative numbers:

```
//and returns a negative if both operands are negative...
assert (-1g & -1g) == -1g

//or returns a negative number if either operand is negative...
assert (1g | -1g) == -1g

//xor returns a negative number if exactly one operand is negative...
assert (1g ^ -1g) == -2g
assert (-1g ^ -2g) == 1g
```

When the two operands are of different lengths, the sign on the shorter of the two operands is virtually extended prior to the operation:

```
assert 11g.and(-2g) == 10g //01011 and 11110 is 01010, ie, 10g
```

JN0525-Decimals

This page last changed on Aug 30, 2007 by [gavingrover](#).

We can only use base-10 notation to represent decimal numbers, not hexadecimal or octal. Decimals are written with a decimal part and/or an exponent part, each with an optional + -. The leading zero is required.

```
[ 1.23e-23, 4.56, -1.7E1, 98.7e2, -0.27e-54 ].each{ assert it } //decimals
assert (-1.23).class == BigDecimal
assert (-1.23g).class == BigDecimal
//BigInteger 'g' suffix after a decimal-formatted number means BigDecimal
```

Such BigDecimals are arbitrary-precision signed decimal numbers. They consist of an unscaled infinitely-extendable value and a 32-bit Integer scale. The value of the number represented by it is (unscaledValue × 10^{*(-scale)}). This means a zero or positive scale is the number of digits to the right of the decimal point; a negative scale is the unscaled value multiplied by ten to the power of the negation of the scale. For example, a scale of -3 means the unscaled value is multiplied by 1000.

We can construct a BigDecimal with a specified scale:

```
assert new BigDecimal( 0, 1 ) == 0.0
assert new BigDecimal( 123, 0 ) == 123
assert new BigDecimal( 123 ) == 123 //default scale is 0
assert new BigDecimal( -123, 0 ) == -123
assert new BigDecimal( 123, -1 ) == 1.23e3
assert new BigDecimal( 12, -3 ) == 12000.0
assert new BigDecimal( 120, 1 ) == 12.0
assert new BigDecimal( 123, 5 ) == 0.00123
assert new BigDecimal( -123, 14 ) == -1.23e-12

assert (2 as BigDecimal).unscaledValue() == 2
assert (2 as BigDecimal).scale() == 0
assert (2 as BigDecimal).scale == 0 //parens optional
assert 2.0.unscaledValue() == 20
assert 2.0.scale == 1
```

All methods and constructors for this class throw NullPointerException when passed a null object reference for any input parameter.

We can enquire the scale of a BigDecimal:

```
assert (1234.567).unscaledValue() == 1234567g
//returns the unscaled portion of a BigInteger

assert (1234.567).scale() == 3 //returns the scale
```

The precision of a BigDecimal is the number of digits in the unscaled value. The precision of a zero value is 1.

```
assert 7.7.precision() == 2
assert (-7.7).precision() == 2
assert 1.000.precision() == 4
```

We can construct a BigDecimal from a string. The value of the resulting scale must lie between Integer.MIN_VALUE and Integer.MAX_VALUE, inclusive.

```
assert '23.45'.toBigDecimal() == 23.45
assert new BigDecimal( '23.45' ) == 23.45
assert new BigDecimal( '-32.8e2' ) == -32.8e2
assert new BigDecimal( '+.9E-7' ) == 0.9e-7
assert new BigDecimal( '+7.E+8' ) == 7e8
assert new BigDecimal( '0.0' ) == 0.0

try{ new BigDecimal( ' 23.45' ); assert 0 }
catch(e){ assert e instanceof NumberFormatException } //whitespace in string
```

If we have the String in a char array and are concerned with efficiency, we can supply that array directly to the BigDecimal:

```
def ca1= ['1', '2', '.', '5'] as char[]
assert new BigDecimal( ca1 ) == 12.5
def ca2= [ 'a', 'b', '9', '3', '.', '4', '5', 'x', 'y', 'z' ] as char[]

assert new BigDecimal( ca2, 2, 5 ) == 93.45
//use 5 chars from the array beginning from index 2
```

There are some different ways of displaying a BigDecimal:

```
assert 1.2345e7.toString() == '1.2345E+7'
//one digit before decimal point, if exponent used

assert 1.2345e7.toPlainString() == '12345000' //no exponent portion
assert 1.2345e7.toEngineeringString() == '12.345E+6' //exponent divisible by 3
```

From Java 5.0, every distinguishable BigDecimal value has a unique string representation as a result of using toString(). If that string representation is converted back to a BigDecimal, then the original value (unscaled-scale pair) will be recovered. This means it can be used as a string representation for exchanging decimal data, or as a key in a HashMap.

```
[ 1.2345e7, 98.76e-3, 0.007, 0.000e4 ].each{
assert new BigDecimal( it.toString() ) == it
}
```

Conversions

We can construct a BigDecimal from integers:

```
assert new BigDecimal( 45i ).scale == 0
assert new BigDecimal( 45L ).scale == 0
```

If we want to buffer frequently-used BigDecimal values for efficiency, we can use the valueOf() method:

```
def a= BigDecimal.valueOf( 12L, -3 )
assert a == 12000.0g && a.scale == -3

def b= BigDecimal.valueOf( 12L )
assert b == 12.0 && b.scale == 0 //default scale is 0

assert BigDecimal.ZERO == 0.0 //These commonly-used values are pre-supplied
assert BigDecimal.ONE == 1.0
assert BigDecimal.TEN == 10.0
```

The BigDecimal can be converted between the BigInteger, Integer, Long, Short, and Byte classes. Numbers converted to fixed-size integers may be truncated, or have the opposite sign.

```
assert 123g as BigDecimal == 123.0
assert 45i as BigDecimal == 45.0
assert 73L as BigDecimal == 73.0
assert 73L.toBigDecimal() == 73.0 //alternative syntax

assert 123.456 as BigInteger == 123g //lost information about the precision
assert 123.456.toBigInteger() == 123g //alternative syntax
assert 73.0 as Long == 73g
assert 73.0 as long == 73g
assert 73.0.toLong() == 73g
assert 73.0.longValue() == 73g //another alternative syntax
assert 45.6789.intValue() == 45g //truncated
assert 259.0.byteValue() == 3 //truncated, only lowest 8 integral bits returned
assert 200.789.byteValue() == -56
//truncated, only lowest 8 integral bits returned, with opposite sign
```

By appending 'Exact' to the asLong()-style method names, we can ensure an ArithmeticException is thrown if any information would be lost in the conversion:

```

assert 123.0.toBigIntegerExact() == 123g //lost information about the precision
try{ 123.456.toBigIntegerExact(); assert false }
catch(e){ assert e instanceof ArithmeticException }

assert 73.0.longValueExact() == 73g

[ { 73.21.longValueExact() },
{ 45.6789.intValueExact() },
{ 73.21.shortValueExact() },
{ 259.0.byteValueExact() },
{ 200.789.byteValueExact() },
].each{
try{ it(); assert false }catch(e){ assert e instanceof ArithmeticException }
}

```

BigDecimal Arithmetic

We can use the same methods and operators on BigDecimal we use with BigInteger:

```

assert 3.4.plus( 3.3 ) == 3.4 + 3.3
assert 3.4.add( 3.3 ) == 3.4 + 3.3 //alternative name for plus
assert 3.4.minus( 2.1 ) == 3.4 - 2.1
assert 3.4.subtract( 2.1 ) == 3.4 - 2.1 //alternative name for minus
assert 3.0.multiply( 3.1 ) == 3.0 * 3.1
assert 3.0.multiply( 3g ) == 3.0 * 3g
assert 7.7.negate() == -7.7 //unary operation/method
assert (-7.7).negate() == -(-7.7)
assert (-7.7).plus() == +(-7.7) //this method provided for symmetry with negate

try{ 3.4.multiply(null); assert 0 }
catch(e){ assert e instanceof NullPointerException }
//all BigDecimal methods throw NullPointerException if passed a null

```

The scale resulting from add or subtract is the maximum scale of each operand; that resulting from multiply is the sum of the scales of the operands:

```

def a = 3.414, b = 3.3
assert a.scale() == 3 && b.scale() == 1
assert (a+b).scale() == 3 //max of 3 and 1
assert (a*b).scale() == 4 //sum of 3 and 1

```

For + - and *, a BigDecimal with any integer type converts it to a BigDecimal:

```

assert (123.45g * 789).class == BigDecimal
assert (123.45g * 789L).class == BigDecimal
assert (123.45g * (89 as byte)).class == BigDecimal

```

We can use a MathContext to change the precision of operations involving BigDecimals:

```

def mc= new java.math.MathContext( 3 )
//precision of 3 in all constructors and methods where used
assert new BigDecimal( 123456, 0, mc ) == 123000g
assert new BigDecimal( -12345, 14, mc ) == -1.23e-10
assert new BigDecimal( '23.4567', mc ) == 23.5
assert new BigDecimal(
['2', '3', '.', '4', '5', '6', '7'] as char[], mc ) == 23.5
assert new BigDecimal(
['2', '3', '.', '4', '5', '6', '7'] as char[], 1, 5, mc ) == 3.46
assert new BigDecimal( 12341, mc ) == 1230
assert new BigDecimal( 1234L, mc ) == 1230

assert 3.45678.add( 3.3, mc ) == 6.76
assert 0.0.add( 3.333333, mc ) == 3.33
assert 3.4567.subtract( 2.1, mc ) == 1.36
assert 0.0.subtract( 2.12345, mc ) == -2.12
assert 3.0.multiply( 3.1234, mc ) == 9.37

```

```

assert (-7.77777).negate( mc ) == 7.78

assert (-7.77777).plus( mc ) == -7.78
//effect identical to that of round(MathContext) method

```

Division

We can create BigDecimals by dividing integers, both fixed-size and BigInteger, for which the result is a decimal number:

```

assert 7g / 4g == 1.75
assert (-7g) / 4g == -1.75
assert ( 1 / 2 ).class == BigDecimal
assert ( 1L / 2L ).class == BigDecimal
assert ( 1g / 2g ).class == BigDecimal

assert ( 1.5 * 2g ).class == BigDecimal
//an expression with a BigDecimal never converts to an integer

assert 1.0.div( 2 ).class == BigDecimal
//we can use a method instead of the operator

try{ 17g / 0; assert 0 }catch(e){ assert e instanceof ArithmeticException }
//division by 0 not allowed

```

Sometimes, the division can return a recurring number. This leads to a loss of exactness:

```

assert 1/3 == 0.3333333333
//BigDecimals with recurring decimals round their result to 10 places...
assert ( (1/3) * 3 ) != 1
//...which leads to inaccuracy in calculations
assert (1/3).precision() == 10
assert 100000/3 == 33333.3333333333
//accuracy before the decimal point is always retained

```

When the scales of both operands in division are quite different, we can lose precision, sometimes even completely:

```

assert (1.0 / 7.0) == 0.1428571429
//instead of "0.142857 with last 6 digits recurring"
assert (1e-5 / 7.0) == 0.0000014286 //precision is 10
assert (1e-9 / 7.0) == 0.0000000001
assert (1e-11 / 7.0) == 0.0
//difference in scale of operands can cause full loss of precision

```

The `ulp()` of a BigDecimal returns the "Units of the Last Place", the difference between the value and next larger having the same number of digits:

```

assert 123.456.ulp() == 0.001 //always 1, but with same scale
assert 123.456.ulp() == (-123.456).ulp()
assert 0.00.ulp() == 0.01

```

Another way of dividing numbers is to use the `divide()` method, different to the `div()` method and `/` operator. The result must be exact when using `divide()`, or an `ArithmeticException` is thrown.

```

assert 1.0.divide( 4.0 ) == 0.25

try{ 1.0.divide( 7.0 ); assert 0 }
catch(e){ assert e instanceof ArithmeticException }
//result must be exact when using divide()

assert 1.234.divide( 4.0 ) == 0.3085
assert 1.05.divide( 1.25 )
assert 1.234.scale() == 3 && 4.0.scale() == 1 && 0.3085.scale() == 4
//scale of result unpredictable
assert 1.05.scale() == 2 && 1.25.scale() == 2 && 0.84.scale() == 2

```

We can change the precision of divide() by using a MathContext:

```
assert (1.0).divide( 7.0, new java.math.MathContext(12) ) == 0.142857142857
//precision is 12

assert (1.0).divide( 7.0, new java.math.MathContext(10) ) == 0.1428571429

assert (1.0).divide( 7.0, new java.math.MathContext(5) ) == 0.14286

try{ 1.0.divide( 7.0, new java.math.MathContext(0) ); assert 0 }
catch(e){ assert e instanceof ArithmeticException }
//precision of 0 same as if no MathContext was supplied
```

MathContext Rounding Modes

As well as specifying required precision for operations in a MathContext, we can also specify the rounding behavior for operations discarding excess precision. Each rounding mode indicates how the least significant returned digit of a rounded result is to be calculated.

If fewer digits are returned than the digits needed to represent the exact numerical result, the discarded digits are called "the discarded fraction", regardless their contribution to the value of the number returned. When rounding increases the magnitude of the returned result, it is possible for a new digit position to be created by a carry propagating to a leading 9-digit. For example, the value 999.9 rounding up with three digits precision would become 1000.

We can see the behaviour of rounding operations for all rounding modes:

```
import java.math.MathContext
import java.math.RoundingMode
//so we don't have to qualify these with java.math when we refer to them
import static java.math.RoundingMode.*
//so we don't have to qualify UP, DOWN, etc with java.math.RoundingMode

def values= [ +5.5, +2.5, +1.6, +1.1, +1.0, -1.0, -1.1, -1.6, -2.5, -5.5 ]
def results= [
(UP): [ 6, 3, 2, 2, 1, -1, -2, -2, -3, -6 ],
(DOWN): [ 5, 2, 1, 1, 1, -1, -1, -1, -2, -5 ],
(CEILING): [ 6, 3, 2, 2, 1, -1, -1, -1, -2, -5 ],
(FLOOR): [ 5, 2, 1, 1, 1, -1, -2, -2, -3, -6 ],
(HALF_UP): [ 6, 3, 2, 1, 1, -1, -1, -2, -3, -6 ],
(HALF_DOWN): [ 5, 2, 2, 1, 1, -1, -1, -2, -2, -5 ],
(HALF_EVEN): [ 6, 2, 2, 1, 1, -1, -1, -2, -2, -6 ],
]

results.keySet().each{ roundMode->
def mc= new MathContext( 1, roundMode )
results[ roundMode ].eachWithIndex{ it, i->
assert new BigDecimal( values[i], mc ) == it
}
}

def mcu= new MathContext( 1, UNNECESSARY )
assert new BigDecimal( 1.0, mcu ) == 1
assert new BigDecimal( -1.0, mcu ) == -1
[ +5.5, +2.5, +1.6, +1.1, -1.1, -1.6, -2.5, -5.5 ].each{
try{ new BigDecimal( it, mcu ); assert 0 }
catch(e){ assert e instanceof ArithmeticException }
}
```

We can thus see:

UP rounds away from zero, always incrementing the digit prior to a non-zero discarded fraction.

DOWN rounds towards zero, always truncating.

CEILING rounds towards positive infinity (positive results behave as for UP; negative results, as for DOWN).

FLOOR rounds towards negative infinity (positive results behave as for DOWN; negative results, as for UP).

HALF_UP rounds towards nearest neighbor; if both neighbors are equidistant, rounds as for UP. (The rounding mode commonly taught in US schools.)
HALF_DOWN rounds towards nearest neighbor; if both neighbors are equidistant, rounds as for DOWN.
HALF_EVEN rounds towards the nearest neighbor; if both neighbors are equidistant, rounds towards the even neighbor. (Known as "banker's rounding.")
UNNECESSARY asserts that the operation has an exact result; if there's an inexact result, throws an ArithmeticException.

There are some default rounding modes supplied for use:

```
import java.math.*
//imports all such classes, including both MathContext and RoundingMode

MathContext.UNLIMITED
//for unlimited precision arithmetic (precision=0 roundingMode=HALF_UP)
MathContext.DECIMAL32
//for "IEEE 754R" Decimal32 format (precision=7 roundingMode=HALF_EVEN)
MathContext.DECIMAL64
//Decimal64 format (precision=16 roundingMode=HALF_EVEN)
MathContext.DECIMAL128
//Decimal128 format (precision=34 roundingMode=HALF_EVEN)

assert MathContext.DECIMAL32.precision == 7

assert MathContext.DECIMAL32.roundingMode == RoundingMode.HALF_EVEN
//precision and roundingMode are properties

assert new BigDecimal( 123456789, 0, MathContext.DECIMAL32 ) == 123456800g
```

Other constructors for MathContext are:

```
import java.math.*
def mc1= new MathContext( 3 )
//by default, uses RoundingMode.HALF_UP rounding mode
assert mc1.roundingMode == RoundingMode.HALF_UP

def mc2= new MathContext( 3, RoundingMode.HALF_UP )
assert mc2.toString() == 'precision=3 roundingMode=HALF_UP'
def mc3= new MathContext( mc2.toString() )
//we can initialize a MathContext from another's string
assert mc3.precision == 3
assert mc3.roundingMode == RoundingMode.HALF_UP
```

The rounding mode setting of a MathContext object with a precision setting of 0 is not used and thus irrelevant.

Cloning BigDecimals but with different scale

We can create a new BigDecimal with the same overall value as but a different scale to an existing one:

```
import java.math.*

def num= 2.2500
assert num.scale == 4 && num.unscaledValue() == 22500
def num2= num.setScale(5)
assert num2 == 2.25000 && num2.scale == 5 && num2.unscaledValue() == 225000
//usual use of changing scale is to increase the scale
def num3= num.setScale(3)
assert num3 == 2.25000 && num3.scale == 3 && num3.unscaledValue() == 2250

assert num.setScale(2) == 2.25
//only BigDecimal returned from method call has changed scale...
assert num.scale == 4 //...while original BigDecimal still has old scale...
num.scale= 3 //...so there's no point using the allowable property syntax
assert num.scale == 4
```



```

try{
num.setScale(1) //we can't change the value when we reduce the scale...
assert false
}catch(e){ assert e instanceof ArithmeticException }
assert 1.125.setScale(2, RoundingMode.HALF_UP) == 1.13
//...unless we use a rounding mode
assert 1.125.setScale(2, BigDecimal.ROUND_HALF_UP) == 1.13 //pre-Java-5 syntax

```

These 8 BigDecimal static fields are older pre-Java-5.0 equivalents for the values in the RoundingMode enum:

```

BigDecimal.ROUND_UP
BigDecimal.ROUND_DOWN
BigDecimal.ROUND_CEILING
BigDecimal.ROUND_FLOOR
BigDecimal.ROUND_HALF_UP
BigDecimal.ROUND_HALF_DOWN
BigDecimal.ROUND_HALF_EVEN
BigDecimal.ROUND_UNNECESSARY

```

There's two methods that let us convert such older names to the newer RoundingMode constants (enums):

```

import java.math.RoundingMode
assert RoundingMode.valueOf( 'HALF_UP' ) == RoundingMode.HALF_UP

assert RoundingMode.valueOf( BigDecimal.ROUND_HALF_DOWN ) ==
RoundingMode.HALF_DOWN

```

Further operations

For the other arithmetic operations, we also usually have the choice of supplying a MathContext or not.

There's two main ways to raise a number to a power. Using `**` and `power()` returns a fixed-size floating-point number, which we'll look at in the next topic on Groovy Floating-Point Math.

```

assert (4.5**3).class == Double
assert 4.5.power(3).class == Double //using equivalent method instead

```

We can raise a BigDecimal to the power using the `pow()` method instead, which always returns an exact BigDecimal. However, this method will be very slow for high exponents. The result can sometimes differ from the rounded result by more than one ulp (unit in the last place).

```

assert 4.5.pow(3) == 91.125 //pow() is different to power()
assert (-4.5).pow(3) == -91.125
assert 4.5.pow(0) == 1.0
assert 0.0.pow(0) == 1.0
try{ 4.5.pow(-1); assert 0 }catch(e){ assert e instanceof ArithmeticException }
//exponent must be integer >=0
try{ 1.1.pow(1000000000); assert 0 }
catch(e){ assert e instanceof ArithmeticException }
//exponent too high for Java 5

//println( 1.1.pow(999999999) )
//warning: this runs for a VERY LONG time when uncommented

```

When we supply a MathContext, the "ANSI X3.274-1996" algorithm is used:

```

import java.math.MathContext
assert 4.5.pow( 3, new MathContext(4) ) == 91.13 //can supply a MathContext
assert 4.5.pow( -1, new MathContext(10) )
//negative exponents allowed when MathContext supplied
try{ 4.5.pow( -1, new MathContext(0) ); assert 0 }
catch(e){ assert e instanceof ArithmeticException }
//ArithmeticException thrown if mc.precision == 0 and n < 0
try{ 4.5.pow( 123, new MathContext(2) ); assert 0 }
catch(e){ assert e instanceof ArithmeticException }

```

```
//ArithmeticException thrown if mc.precision > 0 and
//n has more than mc.precision decimal digits
```

Instead of giving a precision via the MathContext, we can give the desired scale directly:

```
import java.math.RoundingMode
assert 25.497.divide( 123.4567, 5, RoundingMode.UP ) == 0.20653
//specify desired scale of 4, and rounding mode UP
assert 25.497.divide( 123.4567, 5, BigDecimal.ROUND_UP ) == 0.20653
//cater for pre-Java-5.0 syntax
assert 25.497.divide( 123.4567, RoundingMode.UP ) == 0.207
//if no scale given, use same one as dividend (here, 25.497)
assert 25.497.divide( 123.4567, BigDecimal.ROUND_UP ) == 0.207
```

We can divide to an integral quotient, and/or find the remainder. (The preferred scale of the integral quotient is the dividend's less the divisor's.)

```
import java.math.*
mc= new MathContext( 9, RoundingMode.HALF_UP )
assert 25.5.divide( 2.4, mc ) == 10.625

assert 25.5.divideToIntegralValue( 2.4 ) == 10 //rounding mode always DOWN...
assert 25.5.remainder( 2.4 ) == 1.5
assert 25.5.divideToIntegralValue( 2.4, mc ) == 10
//...even when a MathContext says otherwise
assert 25.5.remainder( 2.4, mc ) == 1.5
assert (-25.5).divideToIntegralValue( 2.4, mc ) == -10
assert (-25.5).remainder( 2.4, mc ) == -1.5

try{ 25.5.divideToIntegralValue( 0 ); assert 0 }
catch(e){ assert e instanceof ArithmeticException }

try{ 25.5.remainder( 0 ); assert 0 }
catch(e){ assert e instanceof ArithmeticException }

assert 25.525.remainder( 2.345, new MathContext(1) ) == 2.075
//MathContext's precision only affects quotient calculation;
//remainder always exact so may have more decimal digits

[ [25.5, 2.4], [-27.1, 3.3] ].each{ x, y->
assert x.remainder( y ) ==
x.subtract( x.divideToIntegralValue( y ).multiply( y ) )
}

try{
2552.0.divideToIntegralValue( 2.4, new MathContext(2) )
assert 0
}catch(e){ assert e instanceof ArithmeticException }
//if result needs more decimal digits than supplied MathContext's precision

try{
2552.0.remainder( 2.4, new MathContext(2) )
assert 0
}catch(e){ assert e instanceof ArithmeticException }
//throw if implicit divideToIntegralValue() result needs more decimal digits
//than supplied MathContext's precision

def qr= 25.5.divideAndRemainder( 2.4 )
assert qr[0] == 10 && qr[1] == 1.5
//same results as divideToIntegralValue() and remainder(), but more efficient
```

We can find the absolute value of a BigDecimal:

```
import java.math.*
assert 7.89.abs() == 7.89 //same scale if no MathContext
assert (-7.89).abs() == 7.89
assert (-7.89).abs( new MathContext(2) ) == 7.9
```

The `round()` operation only has a version with a `MathContext` parameter. Its action is identical to that of the `plus(MathContext)` method.

```
assert 7.89.round( new MathContext(2) ) == 7.9
assert 7.89.round( new MathContext(0) ) == 7.89 //no rounding if precision is 0
```

Operations without a MathContext

Not all `BigDecimal` operations have a `MathContext`.

Auto-incrementing and -decrementing work on `BigDecimal`s:

```
def a= 12.315
a++
assert a == 13.315
--a
assert a == 12.315
```

The `signum` method:

```
assert 2.34.signum() == 1
assert (-2.34).signum() == -1
assert 0.0.signum() == 0
```

As with integers, we can compare `BigDecimal`s:

```
assert (2.50 <=> 2.5) == 0 && 2.50.compareTo(2.5) == 0
assert (-3.45 <=> 1.23) == -1 && (-3.45).compareTo(1.23) == -1
assert (1.23 <=> -0.12) == 1 && 1.23.compareTo(-0.12) == 1
assert (1.23 > -0.12) && 1.23.compareTo(-0.12) > 0
```

The `equals()` method and `==` operator are different for `BigDecimal`s. (So we must be careful if we use `BigDecimal` objects as elements in a `SortedSet` or keys in a `SortedMap`, since `BigDecimal`'s natural ordering is inconsistent with `equals()`.)

```
assert ! ( 2.00.equals(2.0) )
//considers whether both unscaledValue and scale are equal
assert 2.00 == 2.0 //only considers the sequence of the two numbers on a line

assert 0.0 == -0.0 && 0.0.equals( -0.0 )
```

We can find the minimum and maximum of two `BigDecimal`s:

```
assert (-2.0).min( 7.3 ) == -2.0
assert 3.5.max( 4.2 ) == 4.2
```

We can move the decimal point to the left or right:

```
import java.math.*
def num= 123.456
assert num.scale == 3
def mpl= num.movePointLeft( 2 )
assert mpl.scale == 5 //scale should be max( number.scale + movement, 0 )
assert mpl == 1.23456
def mpr= num.movePointRight( 4 )
assert mpr.scale == 0 //scale should be max( number.scale - movement, 0 )
assert mpr == 1234560
assert( 3.456.movePointLeft(2) == 0.03456 )
[ -2, -1, 0, 1, 2 ].each{
assert 123.456.movePointLeft( it ) == 123.456.movePointRight( -it )
}
try{ //throw ArithmeticException if scale will overflow on moving decimal point
new BigDecimal( 123456, 128*256*256*256 - 1 ).movePointLeft( 1 )
assert 0
}catch(e){ assert e instanceof ArithmeticException }
```

Another method for moving the decimal point, but by consistent change to the scale:

```
import java.math.*
def num= 123.456
assert num.scale == 3
def mpl= num.scaleByPowerOfTen( 16 )
assert mpl == 1.23456e18
assert mpl.scale == -13 //num.scale - 16
```

We can strip trailing zeros:

```
assert 45.607000.stripTrailingZeros() == 45.607
assert 600.0.stripTrailingZeros() == 6e2
assert new BigDecimal( 6000, 1 ).stripTrailingZeros() == new BigDecimal( 6, -2 )
```

JN0535-Floats

This page last changed on Aug 30, 2007 by [gavingrover](#).

As well as BigDecimal, decimals can have type Float or Double. Unlike BigDecimal which has no size limit, Float and Double are fixed-size, and thus more efficient in calculations. BigDecimal stores its value as base-10 digits, while Float and Double store their values as binary digits. So although using them is more efficient in calculations, the result of calculations will not be as exact as in base-10, eg, $3.1f + 0.4f$ computes to 3.499999910593033, instead of 3.5.

We can force a decimal to have a specific type other than BigDecimal by giving a suffix (F for Float, D for Double):

```
assert 1.200065d.class == Double
assert 1.234f.class == Float
assert (-1.23E23D).class == Double
assert (1.167g).class == BigDecimal
//although g suffix here is optional, it makes examples more readable
```

We can enquire the minimum and maximum values for Floats and Doubles:

```
assert Float.MIN_VALUE == 1.4E-45f
assert Float.MAX_VALUE == 3.4028235E38f
assert Double.MIN_VALUE == 4.9E-324d
assert Double.MAX_VALUE == 1.7976931348623157E308d
```

We can represent infinities by using some predefined constants (prefixed by either Float or Double):

```
assert (1f / 0f) == Double.POSITIVE_INFINITY
assert (-1f / 0f) == Double.NEGATIVE_INFINITY
assert Double.POSITIVE_INFINITY == Float.POSITIVE_INFINITY

assert 0.0f != -(0.0f)
//positive and negative zeroes not equal, when negative is written -(0.0f)
assert 0.0f == -0.0f
//but when negative is written -0.0f, it's evaluated as positive
```

If a nonzero Double literal is too large or too small, it's represented by Double.POSITIVE_INFINITY or Double.NEGATIVE_INFINITY or 0.0:

```
assert Double.MAX_VALUE * Double.MAX_VALUE == Double.POSITIVE_INFINITY
assert Double.MIN_VALUE * Double.MIN_VALUE == 0.0d
assert -Double.MAX_VALUE * Double.MAX_VALUE == Double.NEGATIVE_INFINITY
assert -Double.MAX_VALUE * -Double.MAX_VALUE == Double.POSITIVE_INFINITY
```

Classes Float and Double can both be written uncapitalized, ie, float and double.

```
assert Float.TYPE == float
assert Double.TYPE == double
```

There's a special variable called Double.NaN (and Float.NaN), meaning "Not a Number", which is sometimes returned from math calculations. Once introduced into a math calculation, the result will (usually) be NaN.

Conversions

The Float and Double classes, along with BigDecimal, BigInteger, Integer, Long, Short, and Byte, can all be converted to one another.

Converting numbers to integers may involve rounding or truncation:

```
assert 45.76f as int == 45i //truncated
assert 45.76d as int == 45i
assert 45.76f.toInteger() == 45i //method name
assert 45.76f.toLong() == 45L
assert 200.8f as byte == -56 as byte //sign reversed after truncation
assert 45.76f.toBigInteger() == 45
```

Converting from integers to float or double (may involve rounding):

```
assert 789g as Float == 789f
assert 45i.toFloat() == 45f //method name
assert 789g.toFloat() == 789f
assert 789g.floatValue() == 789f //alternative method name
assert 45i as double == 45d
assert 6789g.toDouble() == 6789d //method name
assert 6789g.doubleValue() == 6789d //alternative method name

assert new BigInteger( '1' + '0'*40 ).floatValue() == Float.POSITIVE_INFINITY
//one with 40 zeroes after it
assert new BigInteger( '1234567890' * 3 ).floatValue() == 1.2345679e29f
//precision lost on conversion
```

Converting from BigDecimal to float or double (may involve rounding):

```
assert 89.980 as float == 89.98f
assert 1.432157168 as float == 1.4321572f //rounded
assert 78.9g.toFloat() == 78.9f
assert 456.789g.floatValue() == 456.789f
assert 6.789g.toDouble() == 6.789d
assert 2345.6789g.doubleValue() == 2345.6789d
assert new BigDecimal( '-' + '1' *45 ).floatValue() == Float.NEGATIVE_INFINITY
assert new BigDecimal( '0.' + '0'*45 + '1' ).floatValue() == 0.0f
assert new BigDecimal( '0.' + '1234567890' *3 ).floatValue() == 0.12345679f
//precision lost on conversion
```

We can convert a double to a float. but there's no Double() constructor accepting a float as an argument.

```
assert 23.45e37d as float == 23.45e37f
assert new Float( 23.45e37d ) == 23.45e37f
assert new Float( 23.45e67d ) == Float.POSITIVE_INFINITY
assert 123.45e12f as double //conversion inexact
```

We can create a Float or Double from a string representation of the number, either base-10 or hex:

```
[ '77', '1.23e-23', '4.56', '-1.7E1', '98.7e2', '-0.27e-30' ].each{
assert it.toFloat()
assert new Float(it)
assert it.toDouble()
assert new Double(it)
}
assert new Float( ' 1.23e-23 ' ) //leading and trailing whitespace removed
try{ new Float( null ); assert 0 }
catch(e){ assert e instanceof NullPointerException }
[ 'NaN', '-NaN', 'Infinity', '-Infinity', '+Infinity' ].each{
assert new Float(it)
}

assert new Float( ' -0xabc.defP7' )
//we can have hexadecimal mantissa, with P indicating exponent
assert new Float( ' 0xABC.DEFp17 ' )
//part after P must be base-10, not more hex
assert new Float( '0X.defP-3f \n' )
//any whitespace OK (spaces, tabs, newlines, carriage returns, etc)
try{ new Float( ' @0X6azQ/3d' ); assert 0 }
catch(e){ assert e instanceof NumberFormatException }
//because the string doesn't contain a parsable number in the form of a Float
assert Float.valueOf( '0xABp17' )
//alternate means of constructing float from string representation
assert Float.parseFloat( '0xABp17' )
//another alternate means of constructing float from string
assert new Double( '0x12bc.89aP7d ' )
```

The string is first converted to a double, then if need be converted to a float.

Converting from double to BigDecimal is only exact when the double has an exact binary representation, eg, 0.5, 0.25. If a float is supplied, it's converted to a double first, then given to the BigDecimal constructor. The scale of the returned BigDecimal is the smallest value such that $(10^{**}scale * val)$ is an integer.

```
assert new BigDecimal(0.25d) == 0.25
//exact conversion because 0.25 has an exact binary representation

assert new BigDecimal(0.1d) ==
0.10000000000000000000000055511151231257827021181583404541015625

(0.1d).toBigDecimal() == new BigDecimal(0.1d) //alternative method name

assert new BigDecimal(0.1f) == 0.100000001490116119384765625
//inexact conversion as 0.1 has a recurring decimal part in binary

assert (0.1f as BigDecimal) == 0.100000001490116119384765625

assert new BigDecimal(0.1d, new java.math.MathContext(25) ) ==
0.10000000000000000000000055511151 //rounds to 25 places as specified
```

A more exact way to convert a double to a BigDecimal:

```
assert BigDecimal.valueOf( 0.25d ) == 0.25
assert BigDecimal.valueOf( 0.1d ) == 0.1
//always exact, because converts double to a string first
assert new BigDecimal( Double.toString( 0.1d ) ) == 0.1
//explicitly convert double to string, then to BigDecimal
assert BigDecimal.valueOf( -23.456e-17d ) == -2.3456E-16
assert BigDecimal.valueOf( -23.456e-17f ) == -2.3455999317674643E-16
//result inexact because float converted to double first

try{ BigDecimal.valueOf( Double.POSITIVE_INFINITY ); assert 0 }
catch(e){ assert e instanceof NumberFormatException }

try{ BigDecimal.valueOf( Double.NaN ); assert 0 }
catch(e){ assert e instanceof NumberFormatException }
//however, infinities and NaN won't convert that way
```

We can convert a float or double to a unique string representation in base-10. There must be at least one digit to represent the fractional part, and beyond that as many, but only as many, more digits as are needed to uniquely distinguish the argument value from adjacent values of type float. (The returned string must be for the float value nearest to the exact mathematical value supplied; if two float representations are equally close to that value, then the string must be for one of them and the least significant bit of the mantissa must be 0.)

```
assert Float.toString( 3.0e6f ) == '3000000.0' //no leading zeros
assert Float.toString( 3.0e0f ) == '3.0' //at least one digit after the point
assert Float.toString( 3.0e-3f ) == '0.0030'
assert Float.toString( 3.0e7f ) == '3.0E7'
//exponent used if it would be > 6 or < -3
assert Float.toString( 3.0e-4f ) == '3.0E-4' //mantissa >= 1 and < 10
```

We can also convert a float or double to a hexadecimal string representation:

```
[          0.0f: '0x0.0p0',
(-0.0f): '0x0.0p0', //no negative sign in hex string rep'n of -0.0f
1.0f: '0x1.0p0', //most returned strings begin with '0x1.' or '-0x1.'
2.0f: '0x1.0p1',
3.0f: '0x1.8p1',
5.0f: '0x1.4p2',
(-1.0f): '-0x1.0p0',
0.5f: '0x1.0p-1',
0.25f: '0x1.0p-2',
(Float.MAX_VALUE): '0x1.fffffep127',
(Float.MIN_VALUE): '0x0.000002p-126',
//low values beginning with '0x0.' are called 'subnormal'
```

```
(Float.NEGATIVE_INFINITY): '-Infinity',
(Float.NaN): 'NaN',
}.each{ k, v->
assert Float.toHexString(k) == v
}
```

We can format integers and decimals using `String.format()`:

```
//Integers ('d')
assert String.format('%d', 45) == '45'
assert String.format('%5d,%1$5o', 46L) == ' 46, 56'
//octal format; each minimum 5 chars wide; use an argument twice
assert String.format('%-4d,%<-5x', 47g) == '47 ,2f  '
//hex format without leading '0x'; left-justified with '-';
//shortcut ('<') for using argument again
assert String.format('%2d,%<1X', 123) == '123,7B'
//hex in uppercase with capital 'X'
assert String.format('%04d', 34) == '0034' //zero-pad
assert String.format('%5d', 12345) == '12,345' //use grouping-separators
assert String.format('%+3d,%2$ 3d', 123L, 456g) == '+123, 456'
//always use plus sign; always use a leading space
assert String.format('%(3d', -789 as short) == '(789)' //parens for negative
assert String.format('%(3o,%2$(3x,%3$(3X', 123g, 456g, -789g) == '173,1c8,(315)'
//neg octal/hex only for BigInteger

//Floating-Point ('f', 'a', 'e', 'g')
assert String.format('e = %f', Math.E) == 'e = 2.718282'
//default 'f' format is 7.6
assert String.format('e=%+6.4f', Math.E) == 'e=+2.7183'
//precision is digits after decimal point
assert String.format('$ %(.6.2f', -6217.58) == '$ (6,217.58)'
//'(' flag gives parens, ',' uses separators
assert String.format('%a, %A', 2.7182818f, Math.PI) ==
'0x1.5bf0a8p1, 0X1.921FB54442D18P1' //'a' for hex
assert String.format('%+010.4a', 23.25d) == '+0x001.7400p4'
//'+ flag always includes sign; '0' flag zero-fills
assert String.format('%e, %10.4e', Math.E, 12345.6789) ==
'2.718282e+00, 1.2346e+04' //'e' for scientific format
assert String.format('%(10.5E', -0.0000271) == '(2.71000E-05)'
assert String.format('%g, %10.4G', Math.E, 12345.6789) == '2.71828, 1.235E+04'
//'f' or 'e', depending on input
```

Floating-Point Arithmetic

We can perform the same basic operations that integers and `BigDecimal` can:

```
assert 3.4f.plus( 3.3f ) == 3.4f + 3.3f
assert 3.4f.minus( 2.1f ) == 3.4f - 2.1f
assert 3.0f.multiply( 3.1f ) == 3.0f * 3.1f
assert 3.0f.multiply( 3f ) == 3.0f * 3f
assert 3.0.multiply( 3f ) == 3.0 * 3f
assert 7.7f.negate() == -7.7f //unary operation/method
assert (-7.7f).negate() == -(-7.7f)
assert +(7.7f) == 7.7f
```

```
try{ 3.4f.multiply(null); assert false }
catch(e){ assert e instanceof NullPointerException }
//methods throw NullPointerException if passed a null
```

For `+` `-` and `*`, anything with a `Double` or `Float` converts both arguments to a `Double`:

```
assert (23.4f + 7.998d).class == Double
assert (23.4f - 123.45g).class == Double
assert (7.998d * 123.45g).class == Double
assert (23.4f - i=789).class == Double
```

We can divide using floats and doubles:

```
assert 2.4f.div( 1.6f ) == ( 2.4f / 1.6f )
assert ( 2.5f / 1i ).class == Double
//produces double result if either operand is float or double
assert ( 2.5f / 1.25 ).class == Double
```

We can perform mod on floats and doubles:

```
def a= 34.56f % 5
assert a == 34.56f.mod(5) && a < 5.0f && a >= 0.0f

def b= 34.56f % 5.1f
assert b == 34.56f.mod(5.1f) && b < 5.0f && b >= 0.0f

def c= -34.56f % 5.1f
assert c == (-34.56f).mod(5.1f) && c <= 0.0f && c > -5.0f
```

IEEEremainder resembles mod in some ways:

```
def Infinity=Double.POSITIVE_INFINITY, NaN=Double.NaN, Zero=0.0d
assert Math.IEEEremainder( 33d, 10d ) == 3d
//give remainder after rounding to nearest value
assert Math.IEEEremainder( 37d, 10d ) == -3d
assert Math.IEEEremainder( -33d, 10d ) == -3d
assert Math.IEEEremainder( -37d, 10d ) == 3d
assert Math.IEEEremainder( 35d, 10d ) == -5d
//when two values equally near, use even number
assert Math.IEEEremainder( 45d, 10d ) == 5d
assert Math.IEEEremainder( Zero, 10d ) == Zero
assert Math.IEEEremainder( -Zero, 10d ) == -Zero
assert Math.IEEEremainder( Infinity, 10d ) == NaN
assert Math.IEEEremainder( 35d, Zero ) == NaN
assert Math.IEEEremainder( 35d, Infinity ) == 35d
```

We can perform other methods:

```
assert (-23.4f).abs() == 23.4f
assert (-23.414d).abs() == 23.414d

assert 14.49f.round() == 14i
assert 14.5f.round() == 15i
assert (-14.5f).round() == -14i
assert 14.555d.round() == 15L
```

We can raise a float or double to a power:

```
assert 4.5f**3 == 91.125d //double returned
assert 4.5f.power(3) == 4.5f**3 //using equivalent method instead
assert 1.1.power(1000000000) == Double.POSITIVE_INFINITY
```

We can test whether a float or double is a number and whether it's an infinite number:

```
def Infinity=Double.POSITIVE_INFINITY, NaN=Double.NaN, Zero=0.0d
assert NaN.isNaN()
assert Double.isNaN( NaN )
assert Infinity.isInfinite()
assert (-Infinity).isInfinite()
assert Double.isInfinite( Infinity )
assert Double.isInfinite( -Infinity )
assert Float.isInfinite( Float.NEGATIVE_INFINITY )
```

We can test whether two floats or doubles have equal values using operators or methods:

```
assert 345f.equals( 3.45e2f ) && 345f == 3.45e2f
//equals() and == behave the same in all cases
assert ! 34.5f.equals( 13.4f ) && 34.5f != 13.4f //equivalent
```

```

assert Float.NaN.equals( Float.NaN ) && Float.NaN == Float.NaN

assert 0.0f == -0.0f && 0.0f.equals( -0.0f )
//-0.0f is evaluated as positive zero
assert 0.0f != -(0.0f) && ! 0.0f.equals( -(0.0f) )
//negative zero must be written -(0.0f)

assert 345d.equals( 3.45e2d ) && 345d == 3.45e2d

assert Float.POSITIVE_INFINITY.equals( Float.POSITIVE_INFINITY ) &&
Float.POSITIVE_INFINITY == Float.POSITIVE_INFINITY
assert ! Float.POSITIVE_INFINITY.equals( Float.NEGATIVE_INFINITY ) &&
! ( Float.POSITIVE_INFINITY == Float.NEGATIVE_INFINITY )

```

We can compare floats and doubles using the `<=>` operator, the `compareTo()` method, and the `compare()` static method:

```

assert (2.50f <=> 2.5f) == 0 && 2.50f.compareTo(2.5f) == 0
assert (-3.45f <=> 1.23f) == -1 && (-3.45f).compareTo(1.23f) == -1
assert (1.23d <=> -0.12d) == 1 && 1.23d.compareTo(-0.12d) == 1
assert (-1.23d < -0.12d) && (-1.23d).compareTo(-0.12d) < 0

assert (Float.NaN > Float.POSITIVE_INFINITY) &&
Float.NaN.compareTo(Float.POSITIVE_INFINITY) > 0
assert (0.0f <=> -0.0f) == 0
assert (Float.NaN <=> Float.NaN) == 0 && Float.NaN.compareTo(Float.NaN) == 0
assert Float.compare( 3.4f, 7.9f ) == -1
assert Double.compare( 3.4d, -7.9d ) == 1

```

Auto-incrementing and -decrementing work on floats and doubles:

```

def a= 12.315d
a++
assert a == 13.315d
--a
assert a == 12.315d

```

Non-zero floats and doubles evaluate as true in boolean contexts:

```

assert (1.23d? true: false)
assert ! (0.0f? true: false)

```

Bitwise Operations

We can convert a float to the equivalent int bits, or a double to equivalent float bits. For a float, bit 31(mask `0x80000000`) is the sign, bits 30-23 (mask `0x7f800000`) are the exponent, and bits 22-0 (mask `0x007fffff`) are the mantissa. For a double, bit 63 is the sign, bits 62-52 are the exponent, and bits 51-0 are the mantissa.

```

assert Float.floatToIntBits( 0.0f ) == 0
assert Float.floatToIntBits( 15.15f ) == 0x41726666
assert Float.floatToIntBits( Float.NaN ) == 0x7fc00000
assert Float.floatToIntBits( Float.POSITIVE_INFINITY ) == 0x7f800000
assert Float.floatToIntBits( Float.NEGATIVE_INFINITY ) == (0xff800000 as int)
assert Double.doubleToLongBits( 15.15d ) == 0x402e4cccccccd

```

The methods `floatToRawIntBits()` and `doubleToRawLongBits()` act similarly, except that they preserve Not-a-Number (NaN) values. So If the argument is NaN, the result is the integer or long representing the actual NaN value produced from the last calculation, not the canonical `Float.NaN` value to which all the bit patterns encoding a NaN can be collapsed (ie, `0x7f800001` through `0x7fffffff` and `0xff800001` through `0xffffffff`).

The `intBitsToFloat()` and `longBitsToDouble()` methods act oppositely. In all cases, giving the integer resulting from calling `Float.floatToIntBits()` or `Float.floatToRawIntBits()` to the `intBitsToFloat(int)` method will produce the original floating-point value, except for a few NaN values. Similarly with doubles. These

methods are the only operations that can distinguish between two NaN values of the same type with different bit patterns.

```
assert Float.intBitsToFloat( 0x7fc00000 ) == Float.NaN
assert Float.intBitsToFloat( 0x7f800000 ) == Float.POSITIVE_INFINITY
assert Float.intBitsToFloat( 0xff800000 as int ) == Float.NEGATIVE_INFINITY
assert Float.intBitsToFloat( 0 ) == 0.0f
assert Float.intBitsToFloat( 0x41726666 ) == 15.15f
assert Double.longBitsToDouble( 0x402e4cccccccccd ) == 15.15d
assert Float.intBitsToFloat( Float.floatToIntBits( 15.15f ) ) == 15.15f
```

As well as infinities and NaN, both Float and Double have other constants:

```
assert Float.MAX_VALUE == Float.intBitsToFloat(0x7f7fffff)
assert Float.MIN_NORMAL == Float.intBitsToFloat(0x00800000)
//the smallest positive nonzero normal value
assert Float.MIN_VALUE == Float.intBitsToFloat(0x1)
//the smallest positive nonzero value, including subnormal values
assert Float.MAX_EXPONENT == Math.getExponent(Float.MAX_VALUE)
assert Float.MIN_EXPONENT == Math.getExponent(Float.MIN_NORMAL)
assert Float.MIN_EXPONENT == Math.getExponent(Float.MIN_VALUE) + 1
//for subnormal values
```

Floating-Point Calculations

There are two constants of type Double, Math.PI and Math.E, that can't be represented exactly, not even as a recurring decimal.

The trigonometric functions behave as expected with the argument in radians, but 0.0 isn't represented exactly. For example, sine:

```
assert Math.sin( 0.0 ) == 0.0
assert Math.sin( 0.5 * Math.PI ) == 1.0
assert Math.sin( Math.PI ) < 1e-15 //almost 0.0, but not quite
assert Math.sin( 1.5 * Math.PI ) == -1.0
assert Math.sin( 2 * Math.PI ) > -1e-15 //almost 0.0
assert Math.sin( -0.5 * Math.PI ) == -1.0
assert Math.sin( -Math.PI ) > -1e-15 //almost 0.0
assert Math.sin( -1.5 * Math.PI ) == 1.0
assert Math.sin( -2 * Math.PI ) < 1e-15 //almost 0.0
assert Math.sin( Double.POSITIVE_INFINITY ) == Double.NaN
assert Math.sin( Double.NEGATIVE_INFINITY ) == Double.NaN
```

Other trig functions are:

```
assert Math.cos( Double.POSITIVE_INFINITY ) == Double.NaN
assert Math.tan( Double.NEGATIVE_INFINITY ) == Double.NaN
assert Math.asin( 0.0 ) == 0.0
assert Math.asin( 1.0 ) == 0.5 * Math.PI
assert Math.asin( 1.001 ) == Double.NaN
assert Math.acos( -1.0 ) == Math.PI
assert Math.acos( -1.001 ) == Double.NaN
assert Math.atan( 0.0 ) == 0.0
```

Some logarithmic functions:

```
def Infinity= Double.POSITIVE_INFINITY, NaN= Double.NaN, Zero= 0.0d

[ (Infinity): Infinity,
  10000: 4,
  10: 1,
  1: 0,
  0.1: -1,
  0.00001: -5,
  0.0: -Infinity,
  (-0.001): NaN,
```

```

].each{ k, v -> assert Math.log10(k) == v } //returns base-10 logarithm

[ (Infinity): Infinity,
  (Math.E): 1,
  1: 0,
  0.0: -Infinity,
  (-0.001): NaN,
].each{ k, v -> assert Math.log(k) == v } //returns natural logarithm

assert Math.exp( Infinity ) == Infinity //returns Math.E raised to a power
assert Math.exp( -Infinity ) == 0.0

```

Math.ulp(d) returns the size of the units of the last place for doubles (the difference between the value and the next larger in magnitude).

```

assert Math.ulp( 123.456d ) == Math.ulp( -123.456d )
assert Math.ulp( 0.123456789d ) != Math.ulp( 0.123456789f )
//if Float, a different scale is used

assert Math.ulp( Double.POSITIVE_INFINITY ) == Double.POSITIVE_INFINITY
assert Math.ulp( Double.NEGATIVE_INFINITY ) == Double.POSITIVE_INFINITY
assert Math.ulp( 0.0d ) == Double.MIN_VALUE
assert Math.ulp( Double.MIN_VALUE ) == Double.MIN_VALUE
assert Double.MAX_VALUE > Math.ulp( Double.MAX_VALUE )

```

Accuracy of the Math methods is measured in terms of such ulps for the worst-case scenario. If a method always has an error less than 0.5 ulps, the method always returns the floating-point number nearest the exact result, and so is always correctly rounded. However, doing this and maintaining floating-point calculation speed together is impractical. Instead, for the Math class, a larger error bound of 1 or 2 ulps is allowed for certain methods. But most methods with more than 0.5 ulp errors are still required to be semi-monotonic, ie, whenever the mathematical function is non-decreasing, so is the floating-point approximation, and vice versa. Not all approximations that have 1 ulp accuracy meet the monotonicity requirements. sin, cos, tan, asin, acos, atan, exp, log, and log10 give results within 1 ulp of the exact result that are semi-monotonic.

Further Calculations

We can find the polar coordinate of two (x,y) coordinates. The result is within 2 ulps of the exact result, and is semi-monotonic.

```

def Infinity= Double.POSITIVE_INFINITY, NaN= Double.NaN, Zero= 0.0d

[ [ 1d, 1d ]: 0.25d * Math.PI,
  [ 1d, -1d ]: 0.75d * Math.PI,
  [ -1d, 1d ]: -0.25d * Math.PI,
  [ -1d, -1d ]: -0.75d * Math.PI,

  [ 0d, 1d ]: 0d,
  [ -(0d), 1d ]: -(0d),
  [ 0d, -1d ]: Math.PI,
  [ -(0d), -1d ]: -Math.PI, // -(0d) gives huge difference in result to 0d
  [ 1d, 0d ]: 0.5d * Math.PI,
  [ 1d, -(0d) ]: 0.5d * Math.PI,
  [ -1d, 0d ]: -0.5d * Math.PI,
  [ -1d, -(0d) ]: -0.5d * Math.PI,

  [ Double.NaN, 1d ]: Double.NaN, //NaN returned if either argument is NaN

  [ 1d, Infinity ]: 0d,
  [ 1d, -Infinity ]: Math.PI,
  [ -1d, Infinity ]: -(0d),
  [ -1d, -Infinity ]: -Math.PI,
  [ Infinity, 1d ]: 0.5d * Math.PI,
  [ Infinity, -1d ]: 0.5d * Math.PI,
  [ -Infinity, 1d ]: -0.5d * Math.PI,
  [ -Infinity, -1d ]: -0.5d * Math.PI,

```

```

[ Infinity, Infinity ]: 0.25d * Math.PI,
[ Infinity, -Infinity ]: 0.75d * Math.PI,
[ -Infinity, Infinity ]: -0.25d * Math.PI,
[ -Infinity, -Infinity ]: -0.75d * Math.PI,
].each{k,v->
if( Math.atan2( k[0], k[1] ) != v )
println "( ${k[0]}, ${k[1]} ): ${Math.atan2(k[0],k[1])}; $v"
}

```

We can perform the hyperbolic trigonometric functions:

```

assertClose= {it1,it2,ulp->
assert it1 > it2 - ulp*Math.ulp(it2) && it1 < it2 + ulp*Math.ulp(it2)
}
def Infinity=Double.POSITIVE_INFINITY, Zero=0d, NaN=Double.NaN, E=Math.E
assertClose Math.sinh( 2d ), 0.5d*(E**2d - E**-2d), 2.5d
//sinh() result will be with 2.5 ulp of exact value
assert Math.sinh( Infinity ) == Infinity
assert Math.sinh( -Infinity ) == -Infinity
assert Math.sinh( Zero ) == Zero
assert Math.sinh( -Zero ) == -Zero
assertClose Math.cosh( 2d ), 0.5d*(E**2d + E**-2d), 2.5d
assert Math.cosh( Infinity ) == Infinity
assert Math.cosh( -Infinity ) == Infinity
assert Math.cosh( Zero ) == 1d
assert Math.cosh( -Zero ) == 1d
assertClose Math.tanh( 2d ), Math.sinh( 2d )/Math.cosh( 2d ), 2.5d
assert Math.tanh( Infinity ) == 1d
assert Math.tanh( -Infinity ) == -1d
assert Math.tanh( Zero ) == Zero
assert Math.tanh( -Zero ) == -Zero
//once the exact result of tanh is within 1/2 of an ulp of
//the limit value of +/- 1, a correctly signed +/- 1.0 will be returned

```

We can convert between degrees and radians. The conversion is generally inexact.

```

assert Math.toDegrees( Math.PI ) == 180.0
assert Math.toRadians( 90.0 ) == 0.5 * Math.PI

```

We can calculate $(E^{**x})-1$ ($1 + x$) in one call. For values of x near 0, $\text{Math.expml}(x) + 1d$ is much closer than $\text{Math.exp}(x)$ to the true result of e^{**x} . The result will be semi-monotonic, and within 1 ulp of the exact result. Once the exact result of $e^{**x} - 1$ is within 1/2 ulp of the limit value -1, -1d will be returned.

```

assertClose= {it1,it2,ulp->
assert it1 > it2 - ulp*Math.ulp(it2) && it1 < it2 + ulp*Math.ulp(it2)
}
def Infinity=Double.POSITIVE_INFINITY, NaN=Double.NaN, Zero= 0d, E= Math.E

assertClose Math.expml( 123.4d ), E**123.4d - 1, 31
assertClose Math.expml( 23.4d ), E**23.4d - 1, 10
assertClose Math.expml( 3.4d ), E**3.4d - 1, 3
assert Math.expml( Infinity ) == Infinity
assert Math.expml( -Infinity ) == -1d
assert Math.expml( Zero ) == Zero
assert Math.expml( -Zero ) == -Zero

```

We can also calculate $\ln(1 + x)$ in one call. For small values of x , $\text{Math.log1p}(x)$ is much closer than $\text{Math.log}(1d + x)$ to the true result of $\ln(1 + x)$. The result will be semi-monotonic, and within 1 ulp of the exact result.

```

def Infinity=Double.POSITIVE_INFINITY, NaN=Double.NaN, Zero= 0d
assert Math.log1p( 123.4d ) == Math.log(1d + 123.4d)
assert Math.log1p( 23.4d ) == Math.log(1d + 23.4d)
assert Math.log1p( 3.4d ) == Math.log(1d + 3.4d)
assert Math.log1p( -1.1d ) == NaN
assert Math.log1p( Infinity ) == Infinity

```

```

assert Math.loglp( -1d ) == -Infinity
assert Math.loglp( Zero ) == Zero
assert Math.loglp( -Zero ) == -Zero

```

Scale binary `scalb(x,y)` calculates $(x * y^{**2})$ using a single operation, giving a more accurate result. If the exponent of the result would be larger than `Float/Double.MAX_EXPONENT`, an infinity is returned. If the result is subnormal, precision may be lost. When the result is non-NaN, the result has the same sign as `x`.

```

def Infinity= Double.POSITIVE_INFINITY, NaN= Double.NaN, Zero= 0.0d
assert Math.scalb(5, 3) == 5 * 2**3
assert Math.scalb(NaN, 3) == NaN
assert Math.scalb(Infinity, 3) == Infinity //same sign
assert Math.scalb(Zero, 3) == Zero //same sign

```

We have square root and cube root methods. For `cbrt`, the computed result must be within 1 ulp of the exact result.

```

def ten= Math.sqrt( 10 ) * Math.sqrt( 10 )
def error= 1e-14
assert ten > 10 - error && ten < 10 + error

assert Math.sqrt( -0.001 ) == Double.NaN
assert Math.sqrt( 0 ) == 0
assert Math.sqrt( Double.POSITIVE_INFINITY ) == Double.POSITIVE_INFINITY

def ten= Math.cbrt( 10 ) * Math.cbrt( 10 ) * Math.cbrt( 10 )
def error= 1e-14
assert ten > 10 - error && ten < 10 + error

assert Math.cbrt( -123.456 ) == -Math.cbrt( 123.456 )
assert Math.cbrt( 0 ) == 0
assert Math.cbrt( Double.POSITIVE_INFINITY ) == Double.POSITIVE_INFINITY
assert Math.cbrt( Double.NEGATIVE_INFINITY ) == Double.NEGATIVE_INFINITY

```

We can find the ceiling and floor of doubles:

```

assert Math.ceil( 6.77 ) == 7 && Math.floor( 6.77 ) == 6
assert Math.ceil( -34.43 ) == -34 && Math.floor( -34.43 ) == -35
assert Math.ceil( 0.73 ) == 1.0 && Math.floor( 0.73 ) == 0.0
assert Math.ceil( -0.73 ) == -0.0d && Math.floor( -0.73 ) == -1.0
//sign required for -0.0d
assert Math.ceil( 13.0 ) == 13.0 && Math.floor( 13.0 ) == 13.0
assert Math.ceil( 0.0 ) == 0.0 && Math.floor( 0.0 ) == 0.0
assert Math.ceil( 23.45 ) == -Math.floor( -23.45 )
//Math.ceil(x) always equals -Math.floor(-x)

```

We can round doubles to the nearest long (or floats to the nearest integer). The calculation is `Math.floor(a + 0.5d)` as Long, or `Math.floor(a + 0.5f)` as Integer

```

[
    7.45: 7,
    7.5: 8,
    (-3.95): -4,
    (-3.5): -3,
    (Double.NaN): 0,
    (Double.NEGATIVE_INFINITY): Long.MIN_VALUE,
    (Long.MIN_VALUE as Double): Long.MIN_VALUE,
    (Double.POSITIVE_INFINITY): Long.MAX_VALUE,
    (Long.MAX_VALUE as Double): Long.MAX_VALUE,
].each{ k, v -> assert Math.round( k ) == v }

```

Unlike the numerical comparison operators, `max()` and `min()` considers negative zero to be strictly smaller than positive zero. If one argument is positive zero and the other negative zero, the result is positive zero.

```

assert Math.max( 7i, 9i ) == 9i //returns the same class as its arguments
assert Math.min( 23L, 19L ) == 19L

```

```

assert Math.min( 1.7f, 0.3f ) == 0.3f
assert Math.min( -6.7d, 1.3d ) == -6.7d
assert Math.min( 7i, 9L ) == 7L //converts result to most precise type of argument
assert Math.min( 1L, 3.3f ) == 1f
assert Math.min( -6.7f, 1.3d ) == -6.699999809265137d

```

Some other methods:

```

[ 7.49d: 7.0d,
7.5d: 8.0d,
8.5d: 8d,
(-7.5d): -8d,
7d: 7d,
0d: 0d,
(Double.POSITIVE_INFINITY): Double.POSITIVE_INFINITY,
].each{ k, v-> assert Math rint( k ) == v }
//round to nearest integer (or even integer)

assert Math.abs( -23i ) == 23i
assert Math.abs( 234L ) == 234L
assert Math.abs( 0i ) == 0i
assert Math.abs( Integer.MIN_VALUE ) == Integer.MIN_VALUE
//WARNING: this result not intuitive
assert Math.abs( Long.MIN_VALUE ) == Long.MIN_VALUE

assert Math.abs( -23.45f ) == 23.45f
assert Math.abs( -123.4d ) == 123.4d
assert Math.abs( 0.0f ) == 0.0f
assert Math.abs( -0.0f ) == 0.0f
assert Math.abs( Float.NEGATIVE_INFINITY ) == Float.POSITIVE_INFINITY

[ -23.45f, 781.23f, Float.NEGATIVE_INFINITY ].each{
assert Math.abs(it) ==
Float.intBitsToFloat(0x7fffffff & Float.floatToIntBits(it))
assert Math.abs(it) ==
Float.intBitsToFloat((Float.floatToIntBits(it)<<1)>>1)
} //there's related assertions for doubles

```

The `pow()` method returns the value of the first argument raised to the power of the second argument. If both arguments are integers, then the result is exactly equal to the mathematical result of raising the first argument to the power of the second argument if that result can in fact be represented exactly as a double value. Otherwise, special rules exist for processing zeros and infinities:

```

def Infinity= Double.POSITIVE_INFINITY, NaN= Double.NaN
[
[ 3d, 0d ]: 1d,
[ 3d, -(0d) ]: 1d,
[ 3d, 1d ]: 3d,
[ 3d, Infinity ]: Infinity,
[ -3d, Infinity ]: Infinity,
[ 0.3d, -Infinity ]: Infinity,
[ -0.3d, -Infinity ]: Infinity,
[ 3d, -Infinity ]: 0d,
[ -3d, -Infinity ]: 0d,
[ 0.3d, Infinity ]: 0d,
[ -0.3d, Infinity ]: 0d,
[ 1d, Infinity ]: Double.NaN,
[ 0d, 1d ]: 0d,
[ Infinity, -1d ]: 0d,
[ 0d, -1d ]: Infinity,
[ Infinity, 1d ]: Infinity,
[ -(0d), 2d ]: 0d, //exponent >0 but not finite odd integer
[ -Infinity, -2d ]: 0d, //exponent <0 but not finite odd integer
[ -(0d), 3d ]: -(0d), //exponent is positive finite odd integer
[ -Infinity, -3d ]: -(0d), //exponent is negative finite odd integer
[ -(0d), -2d ]: Infinity, //exponent <0 but not finite odd integer

```

```

[ -Infinity, 2d ]: Infinity, //exponent >0 but not finite odd integer
[ -(0d), -3d ]: -Infinity, //exponent is negative finite odd integer
[ -Infinity, 3d ]: -Infinity, //exponent is positive finite odd integer
[ -3d, 4i ]: {-> def a= Math.abs(-3d); a*a*a*a }(),
//exponent is finite even integer
[ -3d, 5i ]: {-> def a= Math.abs(-3d); -a*a*a*a*a }(),
//exponent is finite odd integer
[ -3d, 2.5 ]: NaN, //exponent is finite and not an integer
[ NaN, 0d ]: 1d //exception to the NaN ripple rule
].each{k, v->
assert Math.pow( k[0], k[1] ) == v
}

```

More methods:

```

assert Math.random() >= 0d //this method uses new Random() when first called
assert Math.random() < 1d

```

```

assert Math.signum( 17.75d ) == 1d
assert Math.signum( 17.75f ) == 1f
assert Math.signum( -19.5d ) == -1d
assert Math.signum( 0d ) == 0d
assert Math.signum( -(0d) ) == -(0d)

```

We can use `copySign()` to return a first argument with the sign of the second argument.

```

assert Math.copySign( 34.4f, -2.1f ) == -34.4f
assert Math.copySign( -1234.4d, 2.23d ) == 1234.4d

```

We can compute the hypotenuse with risk of intermediate overflow (or underflow). The computed result is within 1 ulp of the exact result. If one parameter is held constant, the results will be semi-monotonic in the other parameter.

```

def Infinity=Double.POSITIVE_INFINITY, NaN=Double.NaN
assert Math.hypot( 9d, 16d ) == Math.sqrt( 9d**2 + 16d**2 )
assert Math.hypot( Infinity, 234d ) == Infinity
assert Math.hypot( NaN, 234d ) == NaN
assert Math.hypot( Infinity, NaN ) == Infinity

```

We can get the exponent from the binary representation of a double or float:

```

def Infinity=Double.POSITIVE_INFINITY, Zero=0d, NaN=Double.NaN, E=Math.E
assert Math.getExponent(2.345e31d) <= Double.MAX_EXPONENT
assert Math.getExponent(2.345e31d) >= Double.MIN_EXPONENT
assert Math.getExponent( NaN ) == Double.MAX_EXPONENT + 1
assert Math.getExponent( Infinity ) == Double.MAX_EXPONENT + 1

assert Math.getExponent( Zero ) == Double.MIN_EXPONENT - 1
//this is also the value of subnormal exponents

assert Math.getExponent(12.3e4f) <= Float.MAX_EXPONENT &&
Math.getExponent(12.3e4f) >= Float.MIN_EXPONENT

```

We can return the floating point number adjacent to the first arg in the direction of the second arg:

```

def Infinity=Double.POSITIVE_INFINITY, NaN=Double.NaN, Zero= 0d
assert Math.nextAfter( 12.34d, 999d ) == 12.34d + Math.ulp( 12.34d )
assert Math.nextAfter( 12.34d, -999d ) == 12.34d - Math.ulp( 12.34d )
assert Math.nextAfter( 12.34f, 999f ) == 12.34f + Math.ulp( 12.34f )
assert Math.nextAfter( 12.34d, 12.34d ) == 12.34d
//if numbers equal, return second one
assert Math.nextAfter( Zero, -Zero ) == -Zero
//numbers are 'equal', and second one returned
assert Math.nextAfter( Double.MIN_VALUE, -12d ) == Zero
assert Math.nextAfter( -Double.MIN_VALUE, 12d ) == -Zero
assert Math.nextAfter( Double.MAX_VALUE, Infinity ) == Infinity
assert Math.nextAfter( -Double.MAX_VALUE, -Infinity ) == -Infinity

```



```
assert Math.nextAfter( Infinity, 12d ) == Double.MAX_VALUE
assert Math.nextAfter( -Infinity, 12d ) == -Double.MAX_VALUE
assert Math.nextAfter( Zero, Infinity ) == Double.MIN_VALUE
assert Math.nextAfter( Infinity, Infinity ) == Infinity
assert Math.nextUp( 12.34d ) == Math.nextAfter( 12.34d, Infinity )
//shortcut method for both doubles and floats
```

The result is NaN if the argument is NaN for ulp, sin, cos, tan, asin, acos, atan, exp, log, log10, sqrt, cbrt, IEEEremainder, ceil, floor, rint, atan2, abs, max, min, signum, sinh, cosh, tanh, expm1, log1p, nextAfter, and nextUp.

But not so with pow, round, hypot, copySign, getExponent, and scalb.

There's another math library called StrictMath that's a mirror of Math, with exactly the same methods. However, some methods (eg, sin, cos, tan, asin, acos, atan, exp, log, log10, cbrt, atan2, pow, sinh, cosh, tanh, hypot, expm1, and log1p) follow stricter IEEE rules about what values must be returned. For example, whereas the Math.copySign method usually treats some NaN arguments as positive and others as negative to allow greater performance, the StrictMath.copySign method requires all NaN sign arguments to be treated as positive values.

JN0545-Dates

This page last changed on Aug 30, 2007 by [gavingrover](#).

We use class Date for simple date processing:

```
def today= new Date() //represents the date and time when it is created
println today

//we can add to and subtract from a date...
def tomorrow= today + 1,
dayAfter= today + 2,
yesterday= today - 1,
dayBefore= today - 2
println "\n$dayBefore\n$yesterday\n$today\n$tomorrow\n$dayAfter\n"
assert today + 7 == today.plus(7) && today - 15 == today.minus(15)
//equivalent methods

//we can increment and decrement a date...
def d= today.clone()
d++; assert d == tomorrow
d= d.next(); assert d == dayAfter //equivalent method
d--; assert d == tomorrow
d= d.previous(); assert d == today //equivalent method

//we can compare dates...
assert tomorrow.after(today)
assert yesterday.before(today)
assert tomorrow.compareTo(today) > 0
assert tomorrow.compareTo(dayAfter) < 0
assert dayBefore.compareTo(dayBefore) == 0

def n= today.time //we can convert a Date to a Long
println n
today.time = 0 //long 0 is beginning of 1 Jan 1970 GMT
println today
def sometimeAgo= new Date(0) //we can construct a date with a Long argument
assert sometimeAgo == today
```

Other date and time processing can be done using the GregorianCalendar class:

```
System.setProperty('user.timezone', 'GMT') //we'll look at timezones later

def c= new GregorianCalendar()
println c.time //'time' property gives a Date class
c= Calendar.instance
assert c.class == GregorianCalendar //another way to create a GregorianCalendar
println c.time
assert c.timeInMillis == c.time.time
//we can get the time in milliseconds after 1 Jan 1970 at 0:00:00am GMT

println System.currentTimeMillis() //another way to get the current time
println System.nanoTime()
//time in nano-seconds: good for measuring elapsed computation times

c= new GregorianCalendar(2009, Calendar.JULY, 22) //creates 22 July 2009
c= new GregorianCalendar(2009, Calendar.JULY, 22, 2, 35)
//creates 22 July 2009 at 2:35am GMT
c= new GregorianCalendar(2009, Calendar.JULY, 22, 2, 35, 21)
//creates 22 July 2009 at 2:35:21am GMT

c.clear() //if we clear the fields, we get...
assert c.get(Calendar.ERA) == GregorianCalendar.AD &&
c.get(Calendar.YEAR) == 1970 &&
c.get(Calendar.MONTH) == 0 &&
//dates range from 0 to 11, so this is January
c.get(Calendar.WEEK_OF_MONTH) == 1 && //should be: 0
```

```

c.get(Calendar.DAY_OF_MONTH) == 1 &&
c.get(Calendar.DATE) == 1 && //same as DAY_OF_MONTH
c.get(Calendar.DAY_OF_WEEK) == 5 &&
c.get(Calendar.DAY_OF_WEEK_IN_MONTH) == 1 &&
c.get(Calendar.AM_PM) == Calendar.AM &&
c.get(Calendar.HOUR) == 0 &&
c.get(Calendar.HOUR_OF_DAY) == 0 &&
c.get(Calendar.MINUTE) == 0 &&
c.get(Calendar.SECOND) == 0 &&
c.get(Calendar.MILLISECOND) == 0 &&

c.get(Calendar.WEEK_OF_YEAR) == 1 &&
c.get(Calendar.DAY_OF_YEAR) == 1

def d= new GregorianCalendar()
d.timeInMillis= 0
//we can set the 'time', here 1 Jan 1970 at 00:00:00.000 GMT (Gregorian)
d.time= new Date(0) //alternative syntax
assert d == c

```

GregorianCalendar supports both the Julian and Gregorian calendar systems, supporting one discontinuity, which by default is when the Gregorian calendar was first instituted in some countries, ie, 4 October 1582 (Julian) followed by 15 October, 1582 (Gregorian). The only difference between the calendars is the leap year rule: the Julian specifies leap years every four years, whereas the Gregorian omits century years which are not divisible by 400. Because dates are computed by extrapolating the current rules indefinitely far backward and forward in time, this calendar generates consistent results for all years, although dates obtained are historically accurate only from March 1, 4 AD onward, when modern Julian calendar rules were adopted. Although New Year's Day was March 25 prior to the institution of the Gregorian calendar, to avoid confusion, this calendar always uses January 1.

Dates and times can be formatted easily with String.format(). The first character is 't' or 'T' for each item:

```

def c1= new GregorianCalendar(1995, Calendar.SEPTEMBER, 5, 19, 35, 30, 750)

//dates...
assert String.format('%tY/%<tm/%<td', c1) == '1995/09/05'
assert String.format('%tA %<te %<tB %<ty', c1) == 'Tuesday 5 September 95'
assert String.format('century:%tC, month:%<tb, day:%<te', c1) ==
'century:19, month:Sep, day:5'
assert String.format('month:%th, day of year:%<tj, day of week:%<ta', c1) ==
'month:Sep, day of year:248, day of week:Tue' // 'h' same as 'b'

//times...
assert String.format('%tH:%tM:%tS.%tL', c1) == '19:35:30.750'
assert String.format('%tI%<tp, %<tl%<tp, nanoseconds:%<tN', c1) ==
'07pm, 7pm, nanoseconds:750000000'
assert String.format('%ts', c1) == '810300930'
//seconds since start of 1-Jan-1970 GMT
assert String.format('%tQ', c1) == '810300930750'
//milliseconds since start of 1-Jan-1970 GMT
assert String.format('%tk',
new GregorianCalendar(1995, Calendar.SEPTEMBER, 5, 6, 35)) == '6'

//shortcut formats...
assert String.format('%tF', c1) == '1995-09-05' //date as '%tm/%td/%ty'
assert String.format('%tD', c1) == '09/05/95' //date as '%tY-%tm-%td'
assert String.format('%tT', c1) == '19:35:30' //time as '%tH:%tM:%tS'
assert String.format('%tR', c1) == '19:35' //time as '%tH:%tM'
assert String.format('%tr', c1) == '07:35:30 PM' //time as '%tI:%tM:%tS %Tp'

//additionally...
assert String.format('%tF', new Date(0)) == '1970-01-01'
//we can supply a Date instead of a Calendar
assert String.format('%tF', 0L) == '1970-01-01' //we can also supply a long

```

```

assert String.format('...%15tF...', 0L) == '...      1970-01-01...' //width 15
assert String.format('...%-15tF...', 0L) == '...1970-01-01      ...'
// '-' flag to left-justify

```

After setting fields, we must call any `get()`, `add()`, or `roll()` method, or access the `'timeInMillis'` or `'time'` properties, to cause other relevant fields to update themselves:

```

System.setProperty('user.timezone', 'GMT')

def c= new GregorianCalendar()
c.set( Calendar.ERA, GregorianCalendar.AD )
c.set( Calendar.YEAR, 1949 )
c.set( Calendar.MONTH, Calendar.OCTOBER )
c.set( Calendar.DATE, 31 )
assert String.format('%tF %<ta', c) == '1949-10-31 Mon'

//properties for calculating WEEK_OF_YEAR and WEEK_OF_MONTH fields...
c.firstDayOfWeek = Calendar.SUNDAY //Sunday in most countries, Monday in others
c.minimalDaysInFirstWeek = 1

assert c.get(Calendar.ERA) == GregorianCalendar.AD &&
c.get(Calendar.YEAR) == 1949 &&
c.get(Calendar.MONTH) == 9 && //dates range from 0 to 11, so October
c.get(Calendar.MONTH) == Calendar.OCTOBER && //alternatively
c.get(Calendar.DAY_OF_MONTH) == 31 &&
c.get(Calendar.WEEK_OF_YEAR) == 45 && //range from 1 to 53
c.get(Calendar.WEEK_OF_MONTH) == 6 && //range from 1 to 6
c.get(Calendar.DAY_OF_YEAR) == 304 &&
c.get(Calendar.DAY_OF_WEEK) == 2 && //Monday
c.get(Calendar.DAY_OF_WEEK_IN_MONTH) == 5

//changing the month uses the same year and day of month...
c.set(Calendar.MONTH, Calendar.AUGUST )
c.time //cause other fields to update themselves
assert String.format('%tF %<ta', c) == '1949-08-31 Wed'

c.set(Calendar.MONTH, Calendar.APRIL )
//...but may cause adjustment to roll into following month
c.time
assert String.format('%tF %<ta', c) == '1949-05-01 Sun'

c.set(Calendar.DATE, 31 )
c.set(Calendar.MONTH, Calendar.FEBRUARY )
c.set(Calendar.MONTH, Calendar.SEPTEMBER )

//rolling into following month only occurs when other fields update themselves,
//call this method to trigger it...
c.time

assert String.format('%tF %<ta', c) == '1949-10-01 Sat'
//...so Feb-28 DIDN'T roll into Mar-03

//changing the day of month uses the same month and year...
c.set( Calendar.DATE, 1 ); c.time
assert String.format('%tF %<ta', c) == '1949-10-01 Sat'

//changing the day of year adjusts the month, day, and other date fields...
c.set(Calendar.DAY_OF_YEAR, c.get(Calendar.DAY_OF_YEAR) + 2 ); c.time
assert String.format('%tF %<ta', c) == '1949-10-03 Mon'

//changing the week of year keeps the same day of week, but adjusts
//the other date fields...
c.set(Calendar.WEEK_OF_YEAR, c.get(Calendar.WEEK_OF_YEAR) + 3 ); c.time
assert String.format('%tF %<ta', c) == '1949-10-24 Mon'

//changing the week of month keeps both the same month and day of week...

```

```

c.set(Calendar.WEEK_OF_MONTH, c.get(Calendar.WEEK_OF_MONTH) - 2 ); c.time
assert String.format('%tF %<ta', c) == '1949-10-10 Mon'

//changing the day of week in month also keeps both the
//same month and day of week...
c.set(Calendar.DAY_OF_WEEK_IN_MONTH, c.get(Calendar.DAY_OF_WEEK_IN_MONTH) - 1 )
c.time
assert String.format('%tF %<ta', c) == '1949-10-03 Mon'

//changing the day of week keeps the same week in year...
c.set( Calendar.DAY_OF_WEEK, Calendar.SATURDAY ); c.time
assert String.format('%tF %<ta', c) == '1949-10-08 Sat'
c.set( Calendar.DAY_OF_WEEK, Calendar.SUNDAY ); c.time
assert String.format('%tF %<ta', c) == '1949-10-02 Sun'

```

We can also set the time in this way:

```

System.setProperty('user.timezone', 'GMT')
def c= new GregorianCalendar( 1949, Calendar.OCTOBER, 2 )

c.set( Calendar.AM_PM, Calendar.AM )
c.set( Calendar.HOUR, 6 ) //set the AM_PM and HOUR fields...
c.set( Calendar.MINUTE, 30 )
c.set( Calendar.SECOND, 15 ); c.time
assert String.format('%tF %<tT', c) == '1949-10-02 06:30:15'
assert c.get( Calendar.HOUR_OF_DAY ) == 6
//...and the HOUR_OF_DAY field is updated...

c.set( Calendar.HOUR_OF_DAY, 19 ); c.time
assert String.format('%tF %<tT', c) == '1949-10-02 19:30:15'
assert c.get( Calendar.HOUR ) == 7 && c.get( Calendar.AM_PM ) == Calendar.PM
//...and vice versa

c.set( Calendar.AM_PM, Calendar.AM ); c.time
assert String.format('%tF %<tT', c) == '1949-10-02 07:30:15' &&
c.get( Calendar.AM_PM ) == Calendar.AM

c.set( Calendar.HOUR, 18 ); c.time
//if we set the HOUR with a 24-hr value, it self-adjusts
assert c.get( Calendar.HOUR ) == 6 && c.get( Calendar.AM_PM ) == Calendar.PM

//there's no 24:00, only 00:00 which is 'am', on the following day...
c= new GregorianCalendar(1950, Calendar.JANUARY, 26, 23, 59)
assert String.format('%tF %<tT %<tp', c) == '1950-01-26 23:59:00 pm'
c.add( Calendar.MINUTE, 1 )
assert String.format('%tF %<tT %<tp', c) == '1950-01-27 00:00:00 am'

//12:00 noon is 'pm'...
c= new GregorianCalendar(1950, Calendar.JANUARY, 27, 12, 00)
assert String.format('%tF %<tT %<tp', c) == '1950-01-27 12:00:00 pm'

```

More field manipulations:

```

System.setProperty('user.timezone', 'GMT')

//we can set common fields using terser syntax...
def c= new GregorianCalendar()
c.set( 1947, Calendar.AUGUST, 11 ); c.time
assert String.format('%tF %<ta', c) == '1947-08-11 Mon'
c.set( 1947, Calendar.AUGUST, 12, 6, 30 ); c.time
assert String.format('%tF %<ta', c) == '1947-08-12 Tue'
c.set( 1947, Calendar.AUGUST, 15, 6, 30, 45 ); c.time
assert String.format('%tF %<ta', c) == '1947-08-15 Fri'

//we can clear individual fields, and check if they're set...
assert c.isSet( Calendar.YEAR ) && c.isSet( Calendar.MONTH )
c.clear( Calendar.YEAR )

```

```

assert ! c.isSet( Calendar.YEAR ) && c.isSet( Calendar.MONTH )

//we can check different maximums and minimums of a field...
c.set( 1947, Calendar.APRIL, 11 ); c.time
assert c.getMinimum( Calendar.DATE ) == 1 &&
c.getMaximum( Calendar.DATE ) == 31
assert c.getActualMinimum( Calendar.DATE ) == 1 &&
c.getActualMaximum( Calendar.DATE ) == 30
assert c.getGreatestMinimum( Calendar.DATE ) == 1 &&
c.getLeastMaximum( Calendar.DATE ) == 28

//the first week in a year may be numbered as part of the previous year,
//and in a month as 0...
c.firstDayOfWeek = Calendar.SUNDAY
c.minimalDaysInFirstWeek = 1
c.set( 1954, Calendar.JANUARY, 1 ); c.time
assert String.format( '%tF %<ta', c ) == '1954-01-01 Fri'
assert c.get( Calendar.WEEK_OF_YEAR ) == 1
assert c.get( Calendar.WEEK_OF_MONTH ) == 1

assert c.firstDayOfWeek == Calendar.SUNDAY &&
c.minimalDaysInFirstWeek == 1
c.firstDayOfWeek = Calendar.MONDAY
c.minimalDaysInFirstWeek = 4 //trigger different week numbering
assert c.get( Calendar.WEEK_OF_YEAR ) == 53
assert c.get( Calendar.WEEK_OF_MONTH ) == 0

c.set( 1956, Calendar.DECEMBER, 31 ); c.time
assert String.format( '%tF %<ta', c ) == '1956-12-31 Mon'
assert c.get( Calendar.WEEK_OF_YEAR ) == 1
//last week of year may be numbered as first of next

```

We can compare dates:

```

c1= new GregorianCalendar(2008, Calendar.AUGUST, 8)
c2= new GregorianCalendar(2009, Calendar.JULY, 22)
assert c1.before( c2 ) && c2.after( c1 )
assert c1.compareTo( c2 ) < 0 &&
c2.compareTo( c1 ) > 0 &&
c1.compareTo( c1 ) == 0

```

As well as using set(), calendar fields can be changed using add() and roll(), both of which force all fields to update themselves:

```

def c= new GregorianCalendar(1999, Calendar.AUGUST, 31)
assert String.format( '%tF %<ta', c ) == '1999-08-31 Tue'
c.add( Calendar.MONTH, 13 )
assert String.format( '%tF %<ta', c ) == '2000-09-30 Sat'
//we DON'T roll to Oct-01

c= new GregorianCalendar(1999, Calendar.AUGUST, 31)
c.roll( Calendar.MONTH, 13 ) //rolls a field without changing larger fields
assert String.format( '%tF %<ta', c ) == '1999-09-30 Thu'
c.roll( Calendar.MONTH, true ) //rolls +1
assert String.format( '%tF %<ta', c ) == '1999-10-30 Sat'
c.roll( Calendar.MONTH, false ) //rolls -1
assert String.format( '%tF %<ta', c ) == '1999-09-30 Thu'

```

We can turn off the lenient mode for field updates to force us to give calendars precisely correct values:

```

System.setProperty( 'user.timezone', 'GMT' )
def c= new GregorianCalendar( 2002, Calendar.JUNE, 30 )
assert c.lenient
c.set( Calendar.DATE, 31 ); c.time
assert String.format( '%tF %<ta', c ) == '2002-07-01 Mon'

c= new GregorianCalendar( 2002, Calendar.JUNE, 30 )

```

```

c.lenient= false
c.set( Calendar.DATE, 31 )
try{ c.time; assert 0 }catch(e){ assert e in IllegalArgumentException }

```

Durations

We can use durations:

```

import groovy.time.*

class Extras{
static toString(BaseDuration it){
def list= []
if(it.years != 0) list<< "$it.years yrs"
if(it.months != 0) list<< "$it.months mths"
if(it.days != 0) list<< "$it.days days"
if(it.hours != 0) list<< "$it.hours hrs"
if(it.minutes != 0) list<< "$it.minutes mins"
if(it.seconds != 0 || it.millis != 0) list<< "$it.seconds.$it.millis secs"
list.join(', ')
}
}

//enable utility methods for duration classes using 'category' syntax,
//introduced in a later tutorial...
use(Extras){
[ {new TimeDuration( 12, 30, 0, 0 )}: '12 hrs, 30 mins',
{new TimeDuration( 4, 12, 30, 0, 0 )}: '4 days, 12 hrs, 30 mins',
{new Duration( 4, 12, 30, 0, 500 )}: '4 days, 12 hrs, 30 mins, 0.500 secs',
{new DatumDependentDuration( 7, 6, 0, 12, 30, 0, 0 )}:
'7 yrs, 6 mths, 12 hrs, 30 mins',
].each{
assert it.key().toString() == it.value
}
}

def convertToMilliseconds= { yr, mth, day, hr, min, sec, mil->
mil + 1000g*( sec + 60g*( min + 60g*( hr + 24g*(
day + 30g*( mth + 12g*yr )
))))
}

assert new TimeDuration( 12, 30, 0, 0 ).toMilliseconds() ==
convertToMilliseconds( 0, 0, 0, 12, 30, 0, 0 )
//ignores 61-second leap minutes
assert new Duration( 114, 12, 30, 0, 0 ).toMilliseconds() ==
convertToMilliseconds( 0, 0, 114, 12, 30, 0, 0 )
//ignores 25-hour daylight-saving days
assert new DatumDependentDuration( 5, 1, 14, 12, 30, 0, 0 ).toMilliseconds() !=
convertToMilliseconds( 5, 1, 14, 12, 30, 0, 0 )
//considers 31-day months and leap-years

```

These durations can be created more easily within the TimeCategory:

```

import groovy.time.*

//reuse Extras category from a previous example...
use( [Extras, org.codehaus.groovy.runtime.TimeCategory] ){
assert 10.years.class == DatumDependentDuration

assert 10.years.toString() ==
new DatumDependentDuration( 10, 0, 0, 0, 0, 0, 0 ).toString()
assert 4.months.toString() ==
new DatumDependentDuration( 0, 4, 0, 0, 0, 0, 0 ).toString()
assert 7.weeks.toString() == new Duration( 49, 0, 0, 0, 0 ).toString()
assert 5.days.toString() == new Duration( 5, 0, 0, 0, 0 ).toString()

```

```

assert 12.hours.toString() == new TimeDuration( 12, 0, 0, 0 ).toString()
assert 15.minutes.toString() == new TimeDuration( 0, 15, 0, 0 ).toString()
assert 13.seconds.toString() == new TimeDuration( 0, 0, 13, 0 ).toString()
assert 750.milliseconds.toString() ==
new TimeDuration( 0, 0, 0, 750 ).toString()

assert 1.day.toString() == new Duration( 1, 0, 0, 0, 0 ).toString()
//we can use the singular name for any of these...
assert 25.minute.toString() == new TimeDuration( 0, 25, 0, 0 ).toString()
//...even when not grammatical in English
}

```

We can add and subtract durations of different types together:

```

import groovy.time.*

//reuse Extras category from a previous example...
use( [Extras, org.codehaus.groovy.runtime.TimeCategory] ){

assert (10.years + 4.months).class == DatumDependentDuration
assert (10.years + 4.months).toString() ==
new DatumDependentDuration( 10, 4, 0, 0, 0, 0, 0 ).toString()
assert (10.years.plus(4.months) ).toString() ==
(10.years + 4.months).toString() //alternative method name
assert (4.months + 10.years).toString() == (10.years + 4.months).toString()
//all duration operations are commutative

assert (10.years + 4.weeks).class == DatumDependentDuration
assert (5.days + 7.weeks).class == Duration
assert (5.days + 17.hours).class == TimeDuration
assert (10.minutes + 5.seconds).class == TimeDuration

//adding a DatumDependentDuration and a TimeDuration gives a
//specially-defined TimeDatumDependentDuration...
assert (10.years + 12.hours).toString() ==
new TimeDatumDependentDuration( 10, 0, 0, 12, 0, 0, 0 ).toString()
assert (10.years + 12.hours).class == TimeDatumDependentDuration

assert ( 10.years + new TimeDatumDependentDuration( 0, 0, 0, 12, 0, 0, 0 )
).class == TimeDatumDependentDuration
assert ( 10.days + new TimeDatumDependentDuration( 0, 0, 0, 12, 0, 0, 0 )
).class == TimeDatumDependentDuration
assert ( 10.minutes + new TimeDatumDependentDuration( 0, 0, 0, 12, 0, 0, 0 )
).class == TimeDatumDependentDuration
assert ( new TimeDatumDependentDuration( 0, 0, 0, 12, 0, 0, 0 ) +
new TimeDatumDependentDuration( 0, 0, 0, 0, 10, 0, 0 )
).class == TimeDatumDependentDuration

//subtracting durations...
assert (10.years - 4.months).class == DatumDependentDuration
assert (10.years - 4.months).toString() ==
new DatumDependentDuration( 10, -4, 0, 0, 0, 0, 0 ).toString()
assert (10.years.minus(4.months) ).toString() ==
(10.years - 4.months).toString() //alternative method name

assert (10.years - 12.hours).class == DatumDependentDuration
assert (5.days - 7.weeks).class == Duration
assert (5.days - 17.hours).class == TimeDuration
assert (10.minutes - 5.seconds).class == TimeDuration
assert (10.years - 4.weeks).class == DatumDependentDuration
}

```

We can add a Date to a duration to give another Date. A TimeDuration takes leap minutes into account, a Duration also takes daylight saving into account, and a DatumDependentDuration considers 31-day months and leap-years:

```

import groovy.time.*

//reuse Extras category from a previous example...
use( [Extras, org.codehaus.groovy.runtime.TimeCategory] ){

def today= new Date(),
tomorrow= today + 1,
dayAfter= today + 2,
nextWeek= today + 7 //days-only Date arithmetic
assert ( today + 7.days ).toString() == nextWeek.toString()
//use Date and duration together
assert ( today.plus(7.days) ).toString() == ( today + 7.days ).toString()
//alternative method name
assert ( 7.days + today ).toString() == nextWeek.toString()
//commutative
assert ( nextWeek - 6.days ).toString() == tomorrow.toString()
assert ( nextWeek.minus(6.days) ).toString() == tomorrow.toString()
//alternative method name
assert ( nextWeek - dayAfter ).toString() == 5.days.toString()
//subtract two dates to get a duration

//some handy operations...
[2.days.ago, 3.days.from.now, 3.days.from.today].each{
assert it.class == java.sql.Date
}
}

```

Time Zones

We can retrieve lists of all time zones on a system:

```

//we can get all available time zone ID's, and get the time zone for an ID...
TimeZone.availableIDs.toList().groupBy{ TimeZone.getTimeZone(it).rawOffset }.
entrySet().sort{it.key}.reverse().each{
println String.format('%6.2f hrs: %2d',
it.key / (60*60*1000), it.value.size())
it.value.each{
def tz= TimeZone.getTimeZone(it)
println "${' '*8}$tz.displayName ($tz.ID): " +
"${tz.DSTSavings / (60*60*1000)}, ${tz.useDaylightTime()}"
}
}

```

```

//we can get all the available time zone ID's for a specific offset...
TimeZone.getAvailableIDs( 12 * (60*60*1000) ).toList().each{
def tz= TimeZone.getTimeZone(it)
println "$tz.displayName ($tz.ID): " +
"${tz.DSTSavings / (60*60*1000)}, ${tz.useDaylightTime()}"
}

```

We can access various time zones individually:

```

def tz= TimeZone.'default' //look at the default time zone
println "$tz.displayName ($tz.ID): offset $tz.rawOffset, " +
"dstSaving $tz.DSTSavings, useDST ${tz.useDaylightTime()}"

TimeZone.'default'= TimeZone.getTimeZone('GMT') //set the default time zone

//get a specific time zone from the system...
tz = TimeZone.getTimeZone('America/Los_Angeles')
assert tz.displayName == 'Pacific Standard Time' &&
tz.rawOffset == -8 * (60*60*1000) &&
tz.useDaylightTime() &&
tz.DSTSavings == 1 * (60*60*1000)

//we can fetch a custom time zone, without any daylight saving, by

```

```
//supplying a string...
[ 'GMT-8': 'GMT-08:00',
'GMT+11': 'GMT+11:00', //hours must be less than 24
'GMT+0300': 'GMT+03:00',
'GMT-3:15': 'GMT-03:15',
'moo': 'GMT', //syntax errors give GMT
].each{ assert TimeZone.getTimeZone( it.key ).ID == it.value }
```

We can create a time zone with custom daylight-saving time rules:

```
//in the constructor, we can encode the rules for starting or ending
//Daylight Saving time...
def stz= new SimpleTimeZone(-8*(60*60*1000), //base GMT offset: -8:00
"America/Death_Valley",
Calendar.MARCH, 1, 0, //DST starts on 1 March exactly
2*(60*60*1000), SimpleTimeZone.STANDARD_TIME,
//...at 2:00am in standard time (wall time)
Calendar.OCTOBER, 1, -Calendar.SUNDAY,
//ends first Sun on/after 1 Oct (first Sun in Oct)...
2*(60*60*1000), SimpleTimeZone.WALL_TIME,
//...at 2:00am in daylight time (wall time)
1*(60*60*1000) ) // save 1 hour

//leave out last parameter which defaults to 'save 1 hour', ie, 1*(60*60*1000)
stz= new SimpleTimeZone(15*(60*60*1000), //base GMT offset: +15:00
"Pacific/Happy_Isle",
Calendar.AUGUST, -21, -Calendar.FRIDAY,
//starts on last Friday on or before 21 August...
2*(60*60*1000), //...at 2:00am in standard time (wall time, the default)
Calendar.APRIL, 1, -Calendar.SUNDAY,
//ends first Sun on/after 1 Apr (first Sun in Apr)...
2*(60*60*1000) ) //...at 2:00am in daylight time (wall time, the default)

//two extra optional parameters (if present, both must be)...
stz= new SimpleTimeZone( 1*(60*60*1000), //base GMT offset: +1:00
"Europe/Alps",
Calendar.JUNE, 8, -Calendar.MONDAY,
//starts first Mon on/after 8 Jun (second Mon in Jun)...
1*(60*60*1000), SimpleTimeZone.UTC_TIME, //...at 1:00am in UTC time
Calendar.OCTOBER, -1, Calendar.SUNDAY,
//ends on the last Sunday in October...
1*(60*60*1000), SimpleTimeZone.UTC_TIME, //...at 1:00am in UTC time
1*(60*60*1000) ) // save 1 hour

//we can instead encode the rules in the same way using methods...
stz= new SimpleTimeZone( -8*(60*60*1000), //base GMT offset: -8:00
"America/Death_Valley" ) //no daylight-saving schedule in constructor
stz.setStartRule(Calendar.APRIL, 1, -Calendar.SUNDAY, 2 * 60*60*1000)
//first Sun in Apr
stz.setEndRule(Calendar.OCTOBER, -1, Calendar.SUNDAY, 2 * 60*60*1000)
//last Sun in Oct

assert stz.dSTSavings == 60*60*1000 //the default
stz.dSTSavings= 2 * 60*60*1000
assert stz.dSTSavings == 2 * 60*60*1000
assert stz.getDSTSavings() == 2 * 60*60*1000
//unusually-cased property name 'dSTSavings' has equivalent method names
//'getDSTSavings()' and 'setDSTSavings()'

stz.setStartRule(Calendar.MAY, 1, 2 * 60*60*1000)
//shortcut method for fixed date in month
stz.setStartRule(Calendar.MAY, 10, Calendar.SUNDAY, 2 * 60*60*1000, true)
//shortcut for first Sunday on or after 10 May; true means 'after'
stz.setEndRule(Calendar.OCTOBER, 20, Calendar.SATURDAY, 2 * 60*60*1000, false)
//shortcut for first Saturday on or before 20 October; false means 'before'
```

(Coordinated universal time, UTC, being based on an atomic clock, enables an extra second, a "leap second", to be added as the last second of the day on December 31 or June 30.)

We can use time zones in many various ways:

```
System.setProperty('user.timezone', 'GMT') //we can set the default time zone

def tz= new SimpleTimeZone( -8*(60*60*1000), 'Somewhere',
Calendar.MARCH, 1, 0, 2*(60*60*1000),
Calendar.OCTOBER, 31, 0, 2*(60*60*1000) )
def cal= new GregorianCalendar( tz )
//create a calendar with today's date in a specified time zone
cal= Calendar.getInstance( tz ) //another way

cal= new GregorianCalendar(2009, Calendar.JULY, 22)
//we can create a calendar with the default time zone...
cal.setTimeZone= tz //...then set the time zone
assert cal.getTimeZone == tz
assert cal.get(Calendar.ZONE_OFFSET) == -8*(60*60*1000)
assert cal.get(Calendar.DST_OFFSET) == (60*60*1000)
assert Calendar.FIELD_COUNT == 17
//the number of fields such as DAY_OF_YEAR and ZONE_OFFSET in Calendar

//we can test whether two time zones have the same rules...
assert tz.hasSameRules(
new SimpleTimeZone( -8*(60*60*1000), 'Somewhere Else',
Calendar.MARCH, 1, 0, 2*(60*60*1000),
Calendar.OCTOBER, 31, 0, 2*(60*60*1000)
) )
assert ! tz.hasSameRules(
new SimpleTimeZone( -8*(60*60*1000), 'Somewhere Else',
Calendar.APRIL, 1, 0, 2*(60*60*1000),
Calendar.OCTOBER, 31, 0, 2*(60*60*1000)
) )

//some methods available within TimeCategory...
use(org.codehaus.groovy.runtime.TimeCategory){
cal= new GregorianCalendar( tz )
def today= cal.time
println today.getTimeZone()
println today.getDaylightSavingsOffset() //returns a duration
def nextWeek= today + 7
println( nextWeek.getTime().getDaylightSavingsOffset() )
//a duration also has a daylight savings time offset
println( nextWeek.getRelativeDaylightSavingsOffset( today ) )
}

//we can test if a certain date is in daylight saving time for a time zone...
assert tz.inDaylightTime( new GregorianCalendar(1990, Calendar.MAY, 5).getTime() )
assert ! tz.inDaylightTime(
new GregorianCalendar(1990, Calendar.NOVEMBER, 5).getTime() )

//we can set the first year daylight savings time operates...
tz.startYear= 1973
assert ! tz.inDaylightTime( new GregorianCalendar(1971, Calendar.MAY, 5).getTime() )

//some extra format codes for dates...
println String.format('%tZ', cal)
//to see a string representing the time zone, eg, GMT-07:00
println String.format('%tz', cal) //numeric offset from GMT, eg, -0800
assert String.format('%tc', cal) ==
String.format('%ta %<tb %<td %<tT %<tZ %<tY', cal)

//we can view the Gregorian changeover date...
assert String.format( '%ta %<td %<tb %<tY', cal.gregorianChange ) ==
'Fri 15 Oct 1582' //default for GMT time zone
```

```
cal= new GregorianCalendar()
cal.set(1582, Calendar.OCTOBER, 15)
cal.time
assert String.format( '%ta %<td %<tb %<tY', cal.time - 1 ) ==
'Thu 04 Oct 1582' //the day before the big change

//check for leap years (this instance method acts like a static method)...
[1999, 1998, 1997, 1900, 1800, 1700].each{ assert ! cal.isLeapYear(it) }
[2000, 1996, 1992, 1600, 1500, 1400].each{ assert cal.isLeapYear(it) }
//1500 and before use Julian calendar rules
```

JN1015-Collections

This page last changed on Dec 22, 2007 by [paulk_asert](#).

Lists

A list is an ordered collection of objects:

```
def list = [5, 6, 7, 8]
assert list.size == 4
assert list.size() == 4
assert list.class == ArrayList //the specific kind of list being used

assert list[2] == 7 //indexing starts at 0
assert list.getAt(2) == 7 //equivalent method to []
assert list.get(2) == 7 //alternative method

list[2] = 9
assert list == [5, 6, 9, 8, ] //trailing comma OK

list.putAt(2, 10) //equivalent method to [] when value being changed
assert list == [5, 6, 10, 8]
assert list.set(2, 11) == 10 //alternative method that returns old value
assert list == [5, 6, 11, 8]

assert [ 'a', 1, 'a', 'a', 2.5, 2.5f, 2.5d, 'hello', 7g, null, 9 as byte ]
//objects can be of different types; duplicates allowed

assert [1,2,3,4,5][-1] == 5 //use negative indices to count from the end
assert [1,2,3,4,5][-2] == 4
assert [1,2,3,4,5].getAt(-2) == 4 //getAt() available with negative index...
try{ [1,2,3,4,5].get(-2); assert 0 } //...but not get()
catch(e){ assert e instanceof ArrayIndexOutOfBoundsException }
```

Lists can be evaluated as a boolean value:

```
assert ! [] //an empty list evaluates as false
assert [1] && ['a'] && [0] && [0.0] && [false] && [null]
//all other lists, irrespective of contents, evaluate as true
```

We can use [] to assign a new empty list and << to append items to it:

```
def list = []; assert list.size() == 0
list << 5; assert list.size() == 1
list << 7 << 'i' << 11; assert list == [5, 7, 'i', 11]
list << ['m', 'o']; assert list == [5, 7, 'i', 11, ['m', 'o']]
assert ( [1,2] << 3 << [4,5] << 6 ) == [1,2,3, [4, 5], 6]
//first item in chain of << is target list
assert ([1,2,3] << 4) == ([1,2,3].leftShift(4))
//using this method is equivalent to using <<
```

We can add to a list in many ways:

```
assert [1,2] + 3 + [4,5] + 6 == [1, 2, 3, 4, 5, 6]
assert [1,2].plus(3).plus([4,5]).plus(6) == [1, 2, 3, 4, 5, 6]
//equivalent method for +
def a = [1,2,3]; a += 4; a += [5,6]; assert a == [1,2,3,4,5,6]
assert [1, *[222, 333], 456] == [1, 222, 333, 456]
assert [ *[1,2,3] ] == [1,2,3]
assert [ 1, [2,3,[4,5],6], 7, [8,9] ].flatten() == [1, 2, 3, 4, 5, 6, 7, 8, 9]
```

```
def list= [1,2]
list.add(3) //alternative method name
list.addAll([5,4]) //alternative method name
assert list == [1,2,3,5,4]
```

```
list= [1,2]
```

```

list.add(1,3) //add 3 just before index 1
assert list == [1,3,2]
list.addAll(2,[5,4]) //add [5,4] just before index 2
assert list == [1,3,5,4,2]

list = ['a', 'b', 'z', 'e', 'u', 'v', 'g']
list[8] = 'x'
assert list == ['a', 'b', 'z', 'e', 'u', 'v', 'g', null, 'x']
//nulls inserted if required

```

We can use the each and eachWithIndex methods to execute code on each item in a list:

```

[1, 2, 3].each{ println "Item: $it" }
['a', 'b', 'c'].eachWithIndex{ it, i -> println "$i: $it" }

```

We can construct a list using another's elements as a template:

```

def list1= ['a','b','c']
def list2 = new ArrayList( list1 )
//construct a new list, seeded with the same items as in list1
assert list2 == list1 // == checks that each corresponding element is the same
def list3 = list1.clone()
assert list3 == list1

```

We can perform a closure on each item of a list and return the result:

```

assert [1, 2, 3].collect{ it * 2 } == [2, 4, 6]
//simple call gives single result
assert [1, 2, 3]*.multiply(2) == [1, 2, 3].collect{ it.multiply(2) }
//shortcut syntax instead of collect

def list= []
assert [1, 2, 3].collect( list ){ it * 2 } == [2, 4, 6]
//this style of call gives two identical results
assert list == [2, 4, 6]

```

Other methods on a list return a value:

```

assert [1, 2, 3].find{ it > 1 } == 2
assert [1, 2, 3].findAll{ it > 1 } == [2, 3]
assert ['a','b','c','d','e'].findIndexOf{ it in ['c','e','g'] } == 2
//find first item that satisfies closure
assert [1, 2, 3].every{ it < 5 }
assert ! [1, 2, 3].every{ it < 3 }
assert [1, 2, 3].any{ it > 2 }
assert ! [1, 2, 3].any{ it > 3 }

// sum anything with a plus() method
assert [1,2,3,4,5,6].sum() == 21
assert ['a','b','c','d','e'].sum{
it=='a'?1: it=='b'?2: it=='c'?3: it=='d'?4: it=='e'?5: 0
} == 15
assert ['a','b','c','d','e'].sum{ (char)it - (char)'a' } == 10
assert ['a','b','c','d','e'].sum() == 'abcde'
assert [['a','b'], ['c','d']].sum() == ['a','b','c','d']
// an initial value can be provided
assert [].sum(1000) == 1000
assert [1, 2, 3].sum(1000) == 1006

assert [1, 2, 3].join('-') == '1-2-3'
assert [1, 2, 3].inject('counting: '){ str, item -> str + item } ==
'counting: 123'
assert [1, 2, 3].inject(0){ count, item -> count + item } == 6

```

We can find the maximum and minimum in a collection:

```

def list= [9, 4, 2, 10, 5]

```

```

assert list.max() == 10
assert list.min() == 2
assert Collections.max( list ) == 10
assert Collections.min( list ) == 2
assert ['x', 'y', 'a', 'z'].min() == 'a'
//we can also compare single characters

def list2= ['abc', 'z', 'xyzuvw', 'Hello', '321']
assert list2.max{ it.size() } == 'xyzuvw'
//we can use a closure to spec the sorting behaviour
assert list2.min{ it.size() } == 'z'

```

We can use a "Comparator" to define the comparing behaviour:

```

def mc= [compare:{a,b-> a.equals(b)? 0: a<b? -1: 1}] as Comparator
//this syntax to be explained in a later tutorial
def list= [7,4,9,-6,-1,11,2,3,-9,5,-13]
assert list.max( mc ) == 11
assert list.min( mc ) == -13
assert Collections.max( list, mc ) == 11
assert Collections.min( list, mc ) == -13

def mc2= [
compare: {a,b-> a.equals(b)? 0: Math.abs(a)<Math.abs(b)? -1: 1 }
] as Comparator
//we should always ensure a.equals(b) returns 0, whatever else we do,
//to avoid inconsistent behaviour in many contexts

assert list.max( mc2 ) == -13
assert list.min( mc2 ) == -1
assert list.max{a,b-> a.equals(b)? 0: Math.abs(a)<Math.abs(b)? -1: 1 } == -13
assert list.min{a,b-> a.equals(b)? 0: Math.abs(a)<Math.abs(b)? -1: 1 } == -1

```

We can remove elements from a list by referring to the element/s to be removed:

```

assert ['a','b','c','b','b'] - 'c' == ['a','b','b','b']
//remove 'c', and return resulting list
assert ['a','b','c','b','b'] - 'b' == ['a','c']
//remove all 'b', and return resulting list
assert ['a','b','c','b','b'] - ['b','c'] == ['a']
//remove all 'b' and 'c', and return resulting list
assert ['a','b','c','b','b'].minus('b') == ['a','c']
//equivalent method name for -
assert ['a','b','c','b','b'].minus( ['b','c'] ) == ['a']
def list= [1,2,3,4,3,2,1]
list -= 3
assert list == [1,2,4,2,1] //use -= to remove 3, permanently
assert ( list -= [2,4] ) == [1,1] //remove 2's and 4's, permanently

```

We can remove an element by referring to its index:

```

def list= [1,2,3,4,5,6,2,2,1]
assert list.remove(2) == 3 //remove the third element, and return it
assert list == [1,2,4,5,6,2,2,1]

```

We can remove the first occurrence of an element from a list:

```

def list= ['a','b','c','b','b']
assert list.remove('c') //remove 'c', and return true because element removed
assert list.remove('b')
//remove first 'b', and return true because element removed
assert ! list.remove('z') //return false because no elements removed
assert list == ['a','b','b']

```

We can clear a list of all elements:

```

def list= ['a',2,'c',4]

```

```
list.clear()
assert list == []
```

We can pop the last item from a list, and use the list as a simple stack:

```
def stack= [1,2,4,6]
stack << 7
assert stack == [1,2,4,6,7]
assert stack.pop() == 7
assert stack == [1,2,4,6]
```

Other useful operators and methods:

```
assert 'a' in ['a','b','c']
assert ['a','b','c'].contains('a')
assert [1,3,4].containsAll([1,4])

assert [].isEmpty()
assert [1,2,3,3,3,3,4,5].count(3) == 4

assert [1,2,4,6,8,10,12].intersect([1,3,6,9,12]) == [1,6,12]

assert [1,2,3].disjoint( [4,6,9] )
assert ! [1,2,3].disjoint( [2,4,6] )
assert Collections.disjoint( [1,2,3], [4,6,9] ) //alternative method name
```

There's various ways of sorting:

```
assert [6,3,9,2,7,1,5].sort() == [1,2,3,5,6,7,9]

def list= ['abc', 'z', 'xyzuvw', 'Hello', '321']
assert list.sort{ it.size() } == ['z', 'abc', '321', 'Hello', 'xyzuvw']

def list2= [7,4,-6,-1,11,2,3,-9,5,-13]
assert list2.sort{a,b-> a.equals(b)? 0: Math.abs(a)<Math.abs(b)? -1: 1 } ==
[-1, 2, 3, 4, 5, -6, 7, -9, 11, -13]
def mc= [
compare: {a,b-> a.equals(b)? 0: Math.abs(a)<Math.abs(b)? -1: 1 }
] as Comparator
assert list2.sort(mc) == [-1, 2, 3, 4, 5, -6, 7, -9, 11, -13]

def list3= [6,-3,9,2,-7,1,5]
Collections.sort(list3)
assert list3 == [-7,-3,1,2,5,6,9]
Collections.sort(list3, mc)
assert list3 == [1,2,-3,5,6,-7,9]
```

We can repeat a list or element:

```
assert [1,2,3] * 3 == [1,2,3,1,2,3,1,2,3]
assert [1,2,3].multiply(2) == [1,2,3,1,2,3]
assert Collections.nCopies( 3, 'b' ) == ['b', 'b', 'b']
//nCopies works differently
assert Collections.nCopies( 2, [1,2] ) == [ [1,2], [1,2] ] //not [1,2,1,2]
```

We can find the first or last index of items in a list:

```
assert ['a','b','c','d','c','d'].indexOf('c') == 2 //index returned
assert ['a','b','c','d','c','d'].indexOf('z') == -1
//index -1 means value not in list
assert ['a','b','c','d','c','d'].lastIndexOf('c') == 4
```

Some very common methods are:

```
def list= [], list2= []
[1,2,3,4,5].each{ list << it*2 }
assert list == [2,4,6,8,10]
[1,2,3,4,5].eachWithIndex{item, index-> list2 << item * index }
```



```
//closure supplied must have 2 params
assert list2 == [0,2,6,12,20]
```

A list may contain itself, but equals() may not always be consistent. Consider this:

```
def list, list2, list3
list= [1, 2, list, 4]
list2= [1, 2, list2, 4]
assert list.equals(list2)
list3= [1, 2, list, 4]
assert ! list.equals(list3)
```

Ranges and List-Slicing

Ranges are consecutive lists of sequential values like Integers, and can be used just like a List:

```
assert 5..8 == [5,6,7,8] //includes both values
assert 5..<8 == [5, 6, 7] //excludes specified top value
```

They can also be used with single-character strings:

```
assert ('a'..'d') == ['a','b','c','d']
```

Ranges are handy with the each method:

```
def n=0
(1..10).each{ n += it }
assert n == 55
```

We can define lists using a range or ranges within a list. This is called slicing:

```
assert [*3..5] == [3,4,5]
assert [ 1, *3..5, 7, *9..<12 ] == [1,3,4,5,7,9,10,11]
```

Lists can be used as subscripts to other lists:

```
assert ('a'..'g')[ 3..5 ] == ['d','e','f']
assert ('a'..'g').getAt( 3..5 ) == ['d','e','f'] //equivalent method name
```

```
assert ('a'..'g')[ 1, 3, 5, 6 ] == ['b','d','f','g']
assert ('a'..'g')[ 1, *3..5 ] == ['b','d','e','f']
assert ('a'..'g')[ 1, 3..5 ] == ['b','d','e','f']
//range in subscript flattened automatically
assert ('a'..'g')[-5..-2] == ['c','d','e','f']
assert ('a'..'g').getAt( [ 1, *3..5 ] ) == ['b','d','e','f']
//equivalent method name
assert ('a'..'g').getAt( [ 1, 3..5 ] ) == ['b','d','e','f']
```

We can view a sublist of a list:

```
def list=[1,2,3,4,5], sl= list.subList(2,4)
sl[0]= 9 //if we change the sublist...
assert list == [1,2,9,4,5] //...backing list changes...
list[3]= 11
assert sl == [9,11] //...and vice versa
```

We can perform the same methods on the subscripted lists as we can on the lists they're produced from:

```
assert ['a','b','c','d','e'][1..3].indexOf('c') == 1
//note: index of sublist, not of list
```

We can update items using subscripting too:

```
def list = ['a','b','c','d','e','f','g']
list[2..3] = 'z'
assert list == ['a', 'b', 'z', 'e', 'f', 'g'] //swap two entries for one
list[4..4]= ['u','v']
assert list == ['a', 'b', 'z', 'e', 'u', 'v', 'g'] //swap one entry for two
```

```

def list= ['a', 'b', 'z', 'e', 'u', 'v', 'g']
list[0..1]= []
assert list == ['z', 'e', 'u', 'v', 'g'] //remove entries from index range
list[1..1]= []
assert list == ['z', 'u', 'v', 'g'] //remove entry at index

```

We can also use a method instead of [] with ranges:

```

def list = ['a','b','c','d','e','f','g']
list.putAt(2..3, 'z')
assert list == ['a', 'b', 'z', 'e', 'f', 'g']
list.putAt(4..4, ['u','v'])
assert list == ['a', 'b', 'z', 'e', 'u', 'v', 'g']
list.putAt(1..<3, [])
assert list == ['a', 'e', 'u', 'v', 'g']
list.putAt( 0..<0, 'm' ) //
assert list == ['m', 'a', 'e', 'u', 'v', 'g']
list.removeRange(1,3) //another method to do similar, means: list[1..<3]= []
list[1..2].clear()
assert list == ['m', 'g']

```

More List Utilities

To reverse a list:

```

assert [1,2,3].reverse() == [3,2,1]

def list= ['a','b','c','d','e']
Collections.reverse( list )
assert list == ['e','d','c','b','a']
use(Collections){ list.reverse() }
//alternative syntax for null-returning Collections.reverse(List)
assert list == ['a','b','c','d','e']

def list2= []
[1,2,3,4,5].reverseEach{ list2 << it*2 }
//same as, but more efficient than: [...].reverse().each{...}
assert list2 == [10,8,6,4,2]

assert [1,2,3,4,5,6][3..1] == [4,3,2]
//use backwards range to reverse returned sublist

def list3 = [1, 2, -3, 5, 6, -7, 9]
def rmc= Collections.reverseOrder()
Collections.sort(list3, rmc)
assert list3 == [9, 6, 5, 2, 1, -3, -7]

def list4 = [1, 2, -3, 5, 6, -7, 9]
def mc= [
compare: {a,b-> a.equals(b)? 0: Math.abs(a)<Math.abs(b)? -1: 1}
] as Comparator
def rmc2= Collections.reverseOrder( mc )
Collections.sort(list4, rmc2)
assert list4 == [9, -7, 6, 5, -3, 2, 1]

```

We can perform a binary search on a sorted list:

```

assert Collections.binarySearch([2,5,6,7,9,11,13,26,31,33], 26) == 7
//list must already be sorted
assert Collections.binarySearch([2,5,6,7,9,11,13,31,33], 26) == -8
//if key not there, give negative of one plus the index before which key
//would be if it was there

def mc= [
compare: {a,b-> a.equals(b)? 0: Math.abs(a)<Math.abs(b)? -1: 1 }

```

```

] as Comparator
assert Collections.binarySearch([2,-5,-6,7,9,-11,13,26,31,-33], 26, mc) == 7
//give comparator list sorted by

```

We can remove or retain elements in bulk. `retainAll()` gives the intersection of two lists; `removeAll()` gives the asymmetric difference.

```

def list= ['a','b','c','b','b','e','e']
assert list.removeAll( ['b','z'] )
//remove 'b' and 'z', return true because list changed
assert list == ['a','c','e','e']
assert ! list.removeAll( ['b','z'] )
//return false because list didn't change
assert list == ['a','c','e','e']
assert list.retainAll( ['a','e'] )
//retain only 'a' and 'e', return true because list changed
assert list == ['a','e','e']
assert ! list.retainAll( ['a','e'] )
//retain only 'a' and 'e', return true because list didn't change
assert list == ['a','e','e']

```

Some miscellaneous methods:

```

def list= ['a', 7, 'b', 9, 7, 7, 2.4, 7]
Collections.replaceAll( list, 7, 55)
assert list == ['a', 55, 'b', 9, 55, 55, 2.4, 55]

list= ['a', 7, 'b', 9, 7, 7, 2.4, 7]
use(Collections){ list.replaceAll(7, 55) } //alternative syntax
assert list == ['a', 55, 'b', 9, 55, 55, 2.4, 55]

list= ['a',2,null,4,'zyx',2.5]
use(Collections){ list.fill( 'g' ) } //or: Collections.fill( list, 'g' )
assert list == ['g', 'g', 'g', 'g', 'g', 'g']

list= ['a', 'e', 'i', 'o', 'u', 'z']
use(Collections){ list.swap(2, 4) } //or: Collections.swap(list, 2, 4)
assert list == ['a', 'e', 'u', 'o', 'i', 'z']

assert Collections.frequency(['a','b','a','c','a','a','d','e'], 'a') == 4
use(Collections){
assert ['a','b','a','c','a','a','d','e'].frequency('a') == 4
}

list= ['a','b','c','d','e']
Collections.rotate(list, 3)
assert list == ['c','d','e','a','b']
use(Collections){ list.rotate(-2) }
assert list == ['e','a','b','c','d']

list= [1,2,3,4,5]
Collections.shuffle(list, new Random())
//we can supply our own random number generator...
assert list != [1,2,3,4,5]

list= [1,2,3,4,5]
Collections.shuffle(list) //...or use the default one
assert list != [1,2,3,4,5]

assert [3,5,5,5,2].unique() == [3,5,2]
def mc= [ compare:
{a,b-> a.equals(b) || a.equals(-b)? 0: Math.abs(a)<Math.abs(b)? -1: 1 }
] as Comparator

assert [3,5,5,-5,2,-7].unique(mc) == [3,5,2,-7]
//remove subsequent items comparator considers equal

```

```

assert [3,5,5,-5,2,-7].unique{a, b->
a == b || a == -b? 0: Math.abs(a)<Math.abs(b)? -1: 1
} == [3,5,2,-7]

list= [1,2,3]
Collections.copy( list, [9,8,7] )
assert list == [9,8,7] //overwrites original data
Collections.copy( list, [11,12] ) //source list shorter...
assert list == [11,12,7] //...which leaves remaining entries unchanged
try{ Collections.copy( list, [21,22,23,24] ); assert 0 } //source list too long
catch(e){ assert e instanceof IndexOutOfBoundsException }

list= [1,8,8,2,3,7,6,4,6,6,2,3,7,5]
assert Collections.indexOfSubList( list, [2,3,7] ) == 3
assert Collections.lastIndexOfSubList( list, [2,3,7] ) == 10
assert Collections.indexOfSubList( list, [9,9,13] ) == -1
//if sublist doesn't exist

```

Sets

A set is an unordered collection of objects, with no duplicates. It can be considered as a list with restrictions, and is often constructed from a list:

```

def s1= [1,2,3,3,3,4] as Set,
s2= [4,3,2,1] as Set,
s3= new HashSet( [1,4,2,4,3,4] )
assert s1.class == HashSet && s2.class == HashSet
//the specific kind of set being used
assert s1 == s2
assert s1 == s3
assert s2 == s3
assert s1.asList() && s1.toList()
//a choice of two methods to convert a set to a list
assert ( ([]) as Set) << null << null << null ) == [null] as Set

```

A set should not contain itself as an element.

Most methods available to lists, besides those that don't make sense for unordered items, are available to sets.

```

[ { it[1] }, { it.getAt(1) }, { it.putAt(1,4) }, { it.reverse() } ].each{
try{ it([1,2,3] as Set); assert 0 }
catch(e){ assert e instanceof MissingMethodException }
}

```

The add() and addAll() methods return false if the set wasn't changed as a result of the operation:

```

def s= [1,2] as Set
assert s.add(3)
assert ! s.add(2)
assert s.addAll( [5,4] )
assert ! s.addAll( [5,4] )
assert s == [1,2,3,5,4] as Set

```

Examples with Lists and Sets

For small numbers of items, it's common in Groovy to use a list for set processing, and only convert it to a set when necessary, eg, for output.

Though the uniqueness of set items is useful for some processing, for example, if we want to separate the unique and duplicating items in a list:

```

list=[1,2,7,2,2,4,7,11,5,2,5]
def uniques= [] as Set, dups= [] as Set
list.each{ uniques.add(it) || dups.add(it) }
uniques.removeAll(dups)

```

```
assert uniques == [1,4,11] as Set && dups == [2,5,7] as Set
```

To calculate the symmetric set difference of two sets non-destructively:

```
def s1=[1,2,3,4,5,6], s2=[4,5,6,7,8,9]
def diff = (s1 as Set) + s2
tmp = s1 as Set
tmp.retainAll(s2)
diff.removeAll(tmp)
assert diff == [1,2,3,7,8,9]
```

Sorted Sets

A sorted set is one with extra methods that utilize the sorting of the elements. It's often more efficient than doing the same with lists.

```
def list= [3,2,3,3,1,7,5]
assert new TreeSet(list) == new TreeSet([1,1,1,2,5,7,3,1])
assert new TreeSet(list).toList() == list.unique().sort()

assert new TreeSet(list).first() == list.unique().min()
assert new TreeSet(list).last() == list.unique().max()
```

We can construct a `TreeSet` by giving a comparator to order the elements in the set:

```
def c= [ compare:
{a,b-> a.equals(b)? 0: Math.abs(a)<Math.abs(b)? -1: 1 }
] as Comparator
def ts= new TreeSet( c )
ts<< 3 << -7 << 9 << -2 << -4
assert ts == new TreeSet( [-2, 3, -4, -7, 9] )
assert ts.comparator() == c //retrieve the comparator
```

The range-views, `headSet()` `tailSet()` and `subSet()`, are useful views of the items in a sorted set. These range-views remain valid even if the backing sorted set is modified directly. The sorted set returned by these methods will throw an `IllegalArgumentException` if the user attempts to insert an element out of the range.

```
def ss= new TreeSet(['a','b','c','d','e'])

def hs= ss.headSet('c')
assert hs == new TreeSet(['a','b'])
//return all elements < specified element
hs.remove('a')
assert ss == new TreeSet(['b','c','d','e'])
//headset is simply a view of the data in ss

def ts= ss.tailSet('c')
assert ts == new TreeSet(['c','d','e'])
//return all elements >= specified element
ts.remove('d')
assert ss == new TreeSet(['b','c','e'])
//tailset is also a view of data in ss

def bs= ss.subSet('b','e')
assert bs == new TreeSet(['b','c'])
//return all elements >= but < specified element
bs.remove('c')
assert ss == new TreeSet(['b','e'])
//subset is simply a view of the data in ss

ss << 'a' << 'd'
assert hs == new TreeSet(['a','b'])
//if backing sorted set changes, so do range-views
assert ts == new TreeSet(['d','e'])
assert bs == new TreeSet(['b','d'])
```

For a SortedSet of strings, we can append '\0' to a string to calculate the next possible string:

```
def dic= new TreeSet(
['aardvark', 'banana', 'egghead', 'encephalograph', 'flotsam', 'jamboree']
)
assert dic.subSet('banana', 'flotsam').size() == 3
//incl 'banana' but excl 'flotsam'
assert dic.subSet('banana', 'flotsam\0').size() == 4 //incl both
assert dic.subSet('banana\0', 'flotsam').size() == 2 //excl both
dic.subSet('e', 'f').clear()
assert dic == new TreeSet(
['aardvark', 'banana', 'flotsam', 'jamboree']
)//clear all words beginning with 'e'
```

To go one element backwards from an element elt in a SortedSet:

```
Object predecessor = ss.headSet( elt ).last()
```

Immutable Collections

We can convert a list or set into one that can't be modified:

```
def imList= ['a', 'b', 'c'].asImmutable()
try{ imList<< 'd'; assert 0 }
catch(e){ assert e instanceof UnsupportedOperationException }

imList= Collections.unmodifiableList( ['a', 'b', 'c'] ) //alternative way
try{ imList<< 'd'; assert 0 }
catch(e){ assert e instanceof UnsupportedOperationException }

def imSet= (['a', 'b', 'c'] as Set).asImmutable()
try{ imSet<< 'd'; assert 0 }
catch(e){ assert e instanceof UnsupportedOperationException }

imSet= Collections.unmodifiableSet( ['a', 'b', 'c'] as Set ) //alternative way
try{ imSet<< 'd'; assert 0 }
catch(e){ assert e instanceof UnsupportedOperationException }

def imSortedSet= ( new TreeSet(['a', 'b', 'c']) ).asImmutable()
try{ imSortedSet<< 'd'; assert 0 }
catch(e){ assert e instanceof UnsupportedOperationException }

imSortedSet= Collections.unmodifiableSortedSet( new TreeSet(['a', 'b', 'c']) )
//alternative way
try{ imSortedSet<< 'd'; assert 0 }
catch(e){ assert e instanceof UnsupportedOperationException }
```

We can create an empty list or set that can't be modified:

```
def list= Collections.emptyList()
assert list == []
try{ list<< 'a'; assert 0 }
catch(e){ assert e instanceof UnsupportedOperationException }
list= Collections.EMPTY_LIST
assert list == []
try{ list<< 'a'; assert 0 }
catch(e){ assert e instanceof UnsupportedOperationException }

def set= Collections.emptySet()
assert set == [] as Set
try{ set<< 'a'; assert 0 }
catch(e){ assert e instanceof UnsupportedOperationException }
set= Collections.EMPTY_SET
assert set == [] as Set
try{ set<< 'a'; assert 0 }
catch(e){ assert e instanceof UnsupportedOperationException }
```

We can create a single-element list that can't be modified:

```
def singList= Collections.singletonList('a')
assert singList == ['a']
try{ singList<< 'b'; assert 0 }
catch(e){ assert e instanceof UnsupportedOperationException }

def singSet = Collections.singleton('a')
assert singSet == ['a'] as Set
try{ singSet<< 'b'; assert 0 }
catch(e){ assert e instanceof UnsupportedOperationException }
```

JN1025-Arrays

This page last changed on Aug 30, 2007 by [gavingrover](#).

An object array is a fixed-size sequence of objects:

```
def a= new Object[4] //we must specify the size of the fixed-size array
assert a.size() == 4
assert a.length == 4 //field alternative to size()
a.each{ assert it == null } //default value is null
assert a instanceof Object[]
assert a.class == Object[]

a[0]= 'a'
a[1]= 2 //elements can be any value
a.putAt(2, 'c') //alternative method name syntax
a[3]= false
assert a[0] == 'a' && a[1] == 2 && a.getAt(2) == 'c' && a.getAt(3) == false
//either subscript or method name
assert a[-4] == 'a' && a[-3] == 2 && a[-2] == 'c' && a[-1] == false
//subscripts can be negative

try{ a[4]; assert 0 }
catch(e){ assert e instanceof ArrayIndexOutOfBoundsException }
try{ a[-5]; assert 0 }
catch(e){ assert e instanceof ArrayIndexOutOfBoundsException }

assert a[1..2] == [2, 'c'] //we can use the same subscripting as for lists
assert a[2..2] == ['c']
assert a[0, 2..3] == ['a', 'c', false]

assert a.toList() == ['a', 2, 'c', false]
assert a as List == ['a', 2, 'c', false]
assert a.toArrayString() == '{"a", 2, "c", false}'
```

The subscript used in constructing object arrays is evaluated as an integer:

```
assert new Object[ 0x100000003 ].size() == 3
//index coerced to integer, positive or negative
try{ new Object[ 0x80000000 ]; assert 0 }
catch(e){ assert e instanceof NegativeArraySizeException }
```

We can specify the initial collection of contained objects when we construct the array. Those objects can be any other entity in Groovy, eg, numbers, boolean values, characters, strings, regexes, lists, maps, closures, expandos, classes, class instances, or even other object arrays:

```
assert [
14.25,
17g,
[1,2,3],
'Hello, world',
['a', false, null, 5] as Object[],
new Object[200],
{ it*it },
ArrayList,
] as Object[]
```

We can make a shallow copy using `clone()`:

```
def aq= [1,2]
assert ([ aq, 3 ] as Object[]).clone()[0].is( aq )
//clone() makes a shallow copy only
```

We have a special syntax for constructing multi-dimensional object arrays with null initial values:

```
assert [ new Object[3], new Object[2], new Object[1] ] as Object[]
//usual syntax
assert [ new Object[3], new Object[3], new Object[3] ] as Object[]
```



```
//usual syntax when each constituent array of equal size

def m= new Object[3][3]
//special syntax when each constituent array of equal size
(0..<m.size()).each{i->
(0..<m[i].size()).each{j->
assert m[i][j] == null
//we can also subscript with special syntax using consecutive indexes
}
}
```

We must specify the size of at least the first, outermost, dimension of an object array when we first create it:

```
//ar= new Object[] //compile error when uncommented
ar= new Object[10][]
ar= new Object[10][][]
ar= new Object[10][10][]
```

A multidimensional array need not have arrays of the same length at each level. Thus, a triangular matrix may be created by:

```
def triangle= new Object[100][]
(0..<triangle.length).each{
triangle[it] = new Object[it+1]
}
```

There are strict rules concerning evaluation when subscripting object arrays:

```
class MyException extends Exception{}
def exception(){ throw new MyException() }
def i, a, b

i= 4
a= new Object[i][i=3] //first subscript evaluated before next one
assert a.size() == 4 && a[0].size() == 3

a= [ 11, 12, 13, 14 ] as Object[]
b= [ 3, 2, 1, 0 ] as Object[]
assert a[(a=b)[2]] == 12
//outside of subscript evaluated before inside, ie, a[b[2]] or a[1] or 12

i= 1 //if what's outside subscript throws exception, subscript isn't evaluated
try{ exception()[i=2] }catch(e){ assert i == 1 }

i= 1
a= new Object[2][2]
//if subscript evaluation throws exception, subscripts to right not evaluated
try{ a[ exception() ][i=2] }catch(e){ assert i == 1 }

//index evaluated before indexing occurs (including checking whether
//what's outside subscript is null)...
a= null
try{ a[exception()]; assert 0 }catch(e){ assert e instanceof MyException }
//NullPointerException never occurs here
i= 1
try{ a[i=2]; assert 0 }
catch(e){ assert i == 2 && e instanceof NullPointerException }
```

Implementing an ArrayList with an Object Array

ArrayLists are implemented with object arrays internally. Each ArrayList instance has a capacity, the size of a fixed-size array used to store the elements. This array is always at least as large as the list size, and its capacity grows automatically as elements are added to the list. To see the internal capacity of lists constructed with various values:

```

class Extras{
static enq(List l){ l.elementData.size() }
}
def measure= { list, times->
def sizes= []
times.times{
def size
use(Extras){ size= list.enq() }
(size - list.size() + 1).times{ list << 'a' }
sizes << size
}
sizes
}

def list1= new ArrayList()
def measure1= measure(list1, 10)
assert measure1 == [10, 16, 25, 38, 58, 88, 133, 200, 301, 452]

def list2= new ArrayList(10)
def measure2= measure(list2, 10)
assert measure2 == measure1

def list3= new ArrayList(5)
def measure3= measure(list3, 10)
assert measure3 == [5, 8, 13, 20, 31, 47, 71, 107, 161, 242]

def list4= []
def measure4= measure(list4, 10)
assert measure4 == [0, 1, 2, 4, 7, 11, 17, 26, 40, 61]

def list5= new ArrayList(0)
def measure5= measure(list5, 10)
assert measure5 == measure4

```

For efficiency, we can increase the capacity of a list before adding a large number of elements:

```

class Extras{ static enq(List l){l.elementData.size()} }
use(Extras){
list= []
list.ensureCapacity(200)
assert list.enq() == 200
list<< 'a'<< 'b'<< 'c'
assert list.enq() == 200
list.trimToSize()
//we can also trim the internal fixed-size array to the list size
assert list.enq() == 3
}

```

We can see how many times a list has been modified:

```

list= []<< 'a' << 'b'; assert list.modCount == 2
list.remove('a'); assert list.modCount == 3

```

JN1035-Maps

This page last changed on Jan 21, 2008 by [standtrooper](#).

A map is a mapping from unique unordered keys to values:

```
def map= ['id':'FX-11', 'name':'Radish', 'no':1234, 99:'Y']
//keys can be of any type, and mixed together; so can values
assert map == ['name':'Radish', 'id':'FX-11', 99:'Y', 'no':1234]
//order of keys irrelevant
assert map.size() == 4
assert [1:'a', 2:'b', 1:'c' ] == [1:'c', 2:'b'] //keys unique

def map2= [
'id': 'FX-17',
name: 'Turnip', //string-keys that are valid identifiers need not be quoted
99: 123, //any data can be a key
(-97): 987, //keys with complex syntax must be parenthesized
"tail's": true, //trailing comma OK
]

assert map2.id == 'FX-17'
//we can use field syntax for keys that are valid identifiers
assert map2['id'] == 'FX-17' //we can always use subscript syntax
assert map2.getAt('id') == 'FX-17' //some alternative method names
assert map2.get('id') == 'FX-17'
assert map2['address'] == null //if key doesn't exist in map
assert map2.get('address', 'No fixed abode') == 'No fixed abode'
//default value for non-existent keys

assert map2.class == null
//field syntax always refers to value of key, even if it doesn't exist
//use getClass() instead of class for maps...
assert map2.getClass() == LinkedHashMap //the kind of Map being used

assert map2."tail's" == true
//string-keys that aren't valid identifiers used as field by quoting them
assert ! map2.'99' && ! map2.'-97' //doesn't work for numbers, though

map2.name = 'Potato'
map2[-107] = 'washed, but not peeled'
map2.putAt('alias', 'Spud')
//different alternative method names when assigning value
map2.put('address', 'underground')
assert map2.name == 'Potato' && map2[-107] == 'washed, but not peeled' &&
map2.alias == 'Spud' && map2.address == 'underground'
assert map2 == [ id: 'FX-17', name: 'Potato', alias: 'Spud',
address: 'underground', 99: 123, (-97): 987,
(-107): 'washed, but not peeled', "tail's": true ]

def id= 'address'
def map3= [id: 11, (id): 22]
//if we want a variable's value to become the key, we parenthesize it
assert map3 == [id: 11, address: 22]
```

It's a common idiom to construct an empty map and assign values:

```
def map4= [:]
map4[ 1 ]= 'a'
map4[ 2 ]= 'b'
map4[ true ]= 'p' //we can use boolean values as a key
map4[ false ]= 'q'
map4[ null ]= 'x' //we can also use null as a key
map4[ 'null' ]= 'z'
assert map4 == [1:'a', 2:'b', (true):'p', (false):'q', (null):'x', 'null':'z' ]
```

We can use `each()` and `eachWithIndex()` to access keys and values:

```

def p= new StringBuffer()
[1:'a', 2:'b', 3:'c'].each{ p << it.key +': ' + it.value +'; ' }
//we supply a closure with either 1 param...
assert p.toString() == '1: a; 2: b; 3: c; '

def q= new StringBuffer()
[1:'a', 2:'b', 3:'c'].each{ k, v-> q << k +': ' + v +'; ' } //...or 2 params
assert q.toString() == '1: a; 2: b; 3: c; '

def r= new StringBuffer()
[1:'a', 2:'b', 3:'c'].eachWithIndex{ it, i-> //eachIndex() always takes 2 params
r << it.key +'(' + i +)': ' + it.value +'; '
}
assert r.toString() == '1(0): a; 2(1): b; 3(2): c; '

```

We can check the contents of a map with various methods:

```

assert [:].isEmpty()
assert ! [1:'a', 2:'b'].isEmpty()
assert [1:'a', 2:'b'].containsKey(2)
assert ! [1:'a', 2:'b'].containsKey(4)
assert [1:'a', 2:'b'].containsValue('b')
assert ! [1:'a', 2:'b'].containsValue('z')

```

We can clear a map:

```

def m= [1:'a', 2:'b']
m.clear()
assert m == [:]

```

Further map methods:

```

def defaults= [1:'a', 2:'b', 3:'c', 4:'d'], overrides= [2:'z', 5:'x', 13:'x']
def result= new HashMap(defaults)
result.putAll(overrides)
assert result == [1:'a', 2:'z', 3:'c', 4:'d', 5:'x', 13:'x']
result.remove(2)
assert result == [1:'a', 3:'c', 4:'d', 5:'x', 13:'x']
result.remove(2)
assert result == [1:'a', 3:'c', 4:'d', 5:'x', 13:'x']

```

Great care must be exercised if mutable objects are used as map keys. The behavior of a map is not specified if the value of an object is changed in a manner that affects equals comparisons while the object is a key in the map. A special case of this prohibition is that a map should not contain itself as a key.

Collection views of a map

We can inspect the keys, values, and entries in a view:

```

def m2= [1:'a', 2:'b', 3:'c']

def es=m2.entrySet()
es.each{
assert it.key in [1,2,3]
assert it.value in ['a','b','c']
it.value *= 3 //change value in entry set...
}
assert m2 == [1:'aaa', 2:'bbb', 3:'ccc'] //...and backing map IS updated

def ks= m2.keySet()
assert ks == [1,2,3] as Set
ks.each{ it *= 2 } //change key...
assert m2 == [1:'aaa', 2:'bbb', 3:'ccc'] //...but backing map NOT updated
ks.remove( 2 ) //remove key...
assert m2 == [1:'aaa', 3:'ccc'] //...and backing map IS updated

```

```

def vals= m2.values()
assert vals.toList() == ['aaa', 'ccc']
vals.each{ it = it+'z' } //change value...
assert m2 == [1:'aaa', 3:'ccc'] //...but backing map NOT updated
vals.remove( 'aaa' ) //remove value...
assert m2 == [3:'ccc'] //...and backing map IS updated

vals.clear() //clear values...
assert m2 == [:] //...and backing map IS updated

assert es.is( m2.entrySet() ) //same instance always returned
assert ks.is( m2.keySet() )
assert vals.is( m2.values() )

```

We can use these views for various checks:

```

def m1= [1:'a', 3:'c', 5:'e'], m2= [1:'a', 5:'e']
assert m1.entrySet().containsAll(m2.entrySet())
//true if m1 contains all of m2's mappings
def m3= [1:'g', 5:'z', 3:'x']
m1.keySet().equals(m3.keySet()) //true if maps contain mappings for same keys

```

These views also support the `removeAll()` and `retainAll()` operations:

```

def m= [1:'a', 2:'b', 3:'c', 4:'d', 5:'e']
m.keySet().retainAll( [2,3,4] as Set )
assert m == [2:'b', 3:'c', 4:'d']
m.values().removeAll( ['c','d','e'] as Set )
assert m == [2:'b']

```

Some more map operations:

```

def m= [1:'a', 2:'b', 3:'c', 4:'d', 5:'e']
assert [86: m, 99: 'end'].clone()[86].is( m ) //clone() makes a shallow copy

def c= []
def d= ['a', 'bb', 'ccc', 'dddd', 'eeee']
assert m.collect{ it.value * it.key } == d
assert m.collect(c){ it.value * it.key } == d
assert c == d

assert m.findAll{ it.key == 2 || it.value == 'e' } == [2:'b', 5:'e']
def me= m.find{ it.key % 2 == 0 }
assert [me.key, me.value] in [ [2,'b'], [4,'d'] ]

assert m.toMapString() == '[1:"a", 2:"b", 3:"c", 4:"d", 5:"e"]'

def sm= m.subMap( [2,3,4] )
sm[3]= 'z'
assert sm == [2:'b', 3:'z', 4:'d']
assert m == [1:'a', 2:'b', 3:'c', 4:'d', 5:'e'] //backing map is not modified

assert m.every{ it.value.size() == 1 }
assert m.any{ it.key % 4 == 0 }

```

Getting Map key(s) from a value.

```

def family = [dad:"John" , mom:"Jane", son:"John"]

def val = "John"

```

The simplest way to achieve this with the previous map:

```

assert family.find{it.value == "John"}?.key == "dad"
//or
assert family.find{it.value == val}?.key == "dad"

```

Note that the return is only the key *dad*. As you can see from the *family Map* both *dad* and *son* are keys for the same values.

So, let's get all of the keys with the value "John"

Basically, `findAll` returns a collection of Mappings with the value "John" that we then iterate through and print the key *if* the key is groovy true.

This will place your results for the keys into a *List* of keys

```
def retVal = []
family.findAll{it.value == val}.each{retVal << it?.key}

assert retVal == ["son", "dad"]
```

If you just wanted the collection of Mappings:

```
assert family.findAll{it.value == val} == ["son":"John", "dad":"John"]
//or
def returnValue = family.findAll{it.value == val}
assert returnValue == ["son":"John", "dad":"John"]
```

Special Notations

We can use special notations to access all of a certain key in a list of similarly-keyed maps:

```
def x = [ ['a':11, 'b':12], ['a':21, 'b':22] ]
assert x.a == [11, 21] //GPath notation
assert x*.a == [11, 21] //spread dot notation

x = [ ['a':11, 'b':12], ['a':21, 'b':22], null ]
assert x*.a == [11, 21, null] //caters for null values
assert x*.a == x.collect{ it?.a } //equivalent notation
try{ x.a; assert 0 }catch(e){ assert e instanceof NullPointerException }
//GPath doesn't cater for null values

class MyClass{ def getA(){ 'abc' } }
x = [ ['a':21, 'b':22], null, new MyClass() ]
assert x*.a == [21, null, 'abc'] //properties treated like map subscripting

def c1= new MyClass(), c2= new MyClass()
assert [c1, c2]*.getA() == [c1.getA(), c2.getA()]
//spread dot also works for method calls
assert [c1, c2]*.getA() == ['abc', 'abc']

assert ['z':900, *:['a':100, 'b':200], 'a':300] == ['a':300, 'b':200, 'z':900]
//spread map notation in map definition
assert [ *:[3:3, *:[5:5] ], 7:7] == [3:3, 5:5, 7:7]

def f(){ [ 1:'u', 2:'v', 3:'w' ] }
assert [*:f(), 10:'zz'] == [1:'u', 10:'zz', 2:'v', 3:'w']
//spread map notation in function arguments
def f(m){ m.c }
assert f(*:['a':10, 'b':20, 'c':30], 'e':50) == 30

def f(m, i, j, k){ [m, i, j, k] }
//using spread map notation with mixed unnamed and named arguments
assert f('e':100, *[4, 5], *:['a':10, 'b':20, 'c':30], 6) ==
[ ["e":100, "b":20, "c":30, "a":10], 4, 5, 6 ]
```

Grouping

We can group a list into a map using some criteria:

```
assert [ 'a', 7, 'b', [2,3] ].groupBy{ it.class } == [
(String.class): ['a', 'b'],
(Integer.class): [ 7 ],
```

```
(ArrayList.class): [[2,3]]
]
```

```
assert [
[name:'Clark', city:'London'], [name:'Sharma', city:'London'],
[name:'Maradona', city:'LA'], [name:'Zhang', city:'HK'],
[name:'Ali', city:'HK'], [name:'Liu', city:'HK'],
].groupBy{ it.city } == [
London: [ [name:'Clark', city:'London'],
[name:'Sharma', city:'London'] ],
LA: [ [name:'Maradona', city:'LA'] ],
HK: [ [name:'Zhang', city:'HK'],
[name:'Ali', city:'HK'],
[name:'Liu', city:'HK'] ],
]
```

By using `groupBy()` and `findAll()` on a list of similarly-keyed maps, we can emulate SQL:

```
assert ('The quick brown fox jumps over the lazy dog'.toList()*
toLowerCase() - ' ').
findAll{ it in 'aeiou'.toList() }.
//emulate SQL's WHERE clause with findAll() method
groupBy{ it }.
//emulate GROUP BY clause with groupBy() method
findAll{ it.value.size() > 1 }.
//emulate HAVING clause with findAll() method after the groupBy() one
entrySet().sort{ it.key }.reverse().
//emulate ORDER BY clause with sort() and reverse() methods
collect{ "$it.key:${it.value.size()}" }.join(', ') == 'u:2, o:4, e:3'
```

An example with more than one "table" of data:

```
//find all letters in the "lazy dog" sentence appearing more often than those
//in the "liquor jugs" one...
def dogLetters= ('The quick brown fox jumps over the lazy dog'.toList()*
toLowerCase() - ' '),
jugLetters= ('Pack my box with five dozen liquor jugs'.toList()*
toLowerCase() - ' ')
assert dogLetters.groupBy{ it }.
findAll{ it.value.size() > jugLetters.groupBy{ it }[ it.key ].size() }.
entrySet().sort{it.key}.collect{ "$it.key:${it.value.size()}" }.join(', ') ==
'e:3, h:2, o:4, r:2, t:2'
```

HashMap Internals

A `HashMap` is constructed in various ways:

```
def map1= new HashMap() //uses initial capacity of 16 and load factor of 0.75
def map2= new HashMap(25) //uses load factor of 0.75
def map3= new HashMap(25, 0.8f)
def map4= [:] //the shortcut syntax
```

The capacity is the number of buckets in the `HashMap`, and the initial capacity is the capacity when it's created. The load factor measures how full the `HashMap` will get before its capacity is automatically increased. When the number of entries exceeds the product of the load factor and the current capacity, the `HashMap` is rehashed so it has about twice the number of buckets. A `HashMap` gives constant-time performance for lookup (getting and putting). Iterating over collection views gives time performance proportional to the capacity of the `HashMap` instance plus its the number of keys. So don't set the initial capacity too high or the load factor too low. As a general rule, the default load factor (0.75) offers a good tradeoff between time and space costs. Higher values decrease the space overhead but increase the lookup cost. Creating a `HashMap` with a sufficiently large capacity will allow mappings to be stored more efficiently than letting it perform automatic rehashing as needed to grow the table.

A `HashSet` is implemented with a `HashMap`, and is constructed with the same choices of parameters:

```
def set1= new HashSet() //uses initial capacity of 16 and load factor of 0.75
```

```

def set2= new HashSet(25) //uses load factor of 0.75
def set3= new HashSet(25, 0.8f)
def set4= Collections.newSetFromMap( [:] )
//we can supply our own empty map for the implementation

```

Sorted Maps

A sorted map is one with extra methods that utilize the sorting of the keys. Some constructors and methods:

```

def map= [3:'c', 2:'d', 1:'e', 5:'a', 4:'b'], tm= new TreeMap(map)
assert tm.firstKey() == map.keySet().min() && tm.firstKey() == 1
assert tm.lastKey() == map.keySet().max() && tm.lastKey() == 5
assert tm.findIndexOf{ it.key==4 } == 3

```

We can construct a `TreeMap` by giving a comparator to order the elements in the map:

```

def c= [ compare:
{a,b-> a.equals(b)? 0: Math.abs(a)<Math.abs(b)? -1: 1 }
] as Comparator

def tm= new TreeMap( c )
tm[3]= 'a'; tm[-7]= 'b'; tm[9]= 'c'; tm[-2]= 'd'; tm[-4]= 'e'
assert tm == new TreeMap( [(-2):'d', 3:'a', (-4):'e', (-7):'b', 9:'c'] )
assert tm.comparator() == c //retrieve the comparator

def tm2= new TreeMap( tm ) //use same map entries and comparator
assert tm2.comparator() == c

def tm3= new TreeMap( tm as HashMap )
//special syntax to use same map entries but default comparator only
assert tm3.comparator() == null

```

The range-views, `headMap()` `tailMap()` and `subMap()`, are useful views of the items in a sorted map. They act similarly to the corresponding range-views in a sorted set.

```

def sm= new TreeMap(['a':1, 'b':2, 'c':3, 'd':4, 'e':5])
def hm= sm.headMap('c')
assert hm == new TreeMap(['a':1, 'b':2])
//headMap() returns all elements with key < specified key
hm.remove('a')
assert sm == new TreeMap(['b':2, 'c':3, 'd':4, 'e':5])
//headmap is simply a view of the data in sm
sm['a']= 1; sm['f']= 6
assert sm == new TreeMap(['a':1, 'b':2, 'c':3, 'd':4, 'e':5, 'f':6])
//if backing sorted map changes, so do range-views
def tm= sm.tailMap('c')
assert tm == new TreeMap(['c':3, 'd':4, 'e':5, 'f':6])
//tailMap() returns all elements with key >= specified element
def bm= sm.subMap('b','e')
assert bm == new TreeMap(['b':2, 'c':3, 'd':4])
//subMap() returns all elements with key >= but < specified element
try{ bm['z']= 26; assert 0 }
catch(e){ assert e instanceof IllegalArgumentException }
//attempt to insert an element out of range

```

Immutable Maps

We can convert a map into one that can't be modified:

```

def imMap= (['a':1, 'b':2, 'c':3] as Map).asImmutable()
try{ imMap['d']= 4; assert 0 }
catch(e){ assert e instanceof UnsupportedOperationException }
imMap= Collections.unmodifiableMap( ['a':1, 'b':2, 'c':3] as Map )
//alternative way
try{ imMap['d']= 4; assert 0 }

```



```

catch(e){ assert e instanceof UnsupportedOperationException }

def imSortedMap= ( new TreeMap(['a':1, 'b':2, 'c':3]) ).asImmutable()
try{ imSortedMap['d']= 4; assert 0 }
catch(e){ assert e instanceof UnsupportedOperationException }
imSortedMap= Collections.unmodifiableSortedMap(
new TreeMap(['a':1, 'b':2, 'c':3])
) //alternative way
try{ imSortedMap['d']= 4; assert 0 }
catch(e){ assert e instanceof UnsupportedOperationException }

```

We can create an empty map that can't be modified:

```

def map= Collections.emptyMap()
assert map == [:]
try{ map['a']= 1; assert 0 }
catch(e){ assert e instanceof UnsupportedOperationException }
map= Collections.EMPTY_MAP
assert map == [:]
try{ map['a']= 1; assert 0 }
catch(e){ assert e instanceof UnsupportedOperationException }

```

We can create a single-element list that can't be modified:

```

def singMap = Collections.singletonMap('a', 1)
assert singMap == ['a': 1]
try{ singMap['b']= 2; assert 0 }
catch(e){ assert e instanceof UnsupportedOperationException }

```

Observable Maps

We can convert a map into an observable one with the 'as' keyword too. An observable map will trigger a `PropertyChangeEvent` every time a value changes:

```

// don't forget the imports
import java.beans.*
def map = [:] as ObservableMap
map.addPropertyChangeListener({ evt ->
println "${evt.propertyName}: ${evt.oldValue} -> ${evt.newValue}"
} as PropertyChangeListener)

map.key = 'value' // prints key: null -> value
map.key = 'Groovy' // prints key: value -> Groovy

```

We can also wrap an existing map with an `ObservableMap`

```

import java.beans.*
def sorted = [a:1,b:2] as TreeMap
def map = new ObservableMap(sorted)
map.addPropertyChangeListener({ evt ->
println "${evt.propertyName}: ${evt.oldValue} -> ${evt.newValue}"
} as PropertyChangeListener)
map.key = 'value'
assert ['a','b','key'] == (sorted.keySet() as List)
assert ['a','b','key'] == (map.keySet() as List)

```

Lastly we can specify a closure as an additional parameter, it will work like a filter for properties that should or should not trigger a `PropertyChangeEvent` when their values change, this is useful in conjunction with `Expando`. The filtering closure may take 2 parameters (the property name and its value) or less (the value of the property).

```

import java.beans.*
def map = new ObservableMap({!(it instanceof Closure)})
map.addPropertyChangeListener({ evt ->
println "${evt.propertyName}: ${evt.oldValue} -> ${evt.newValue}"
} as PropertyChangeListener)

```

```
def bean = new Expando( map )
bean.lang = 'Groovy' // prints lang: null -> Groovy
bean.sayHello = { name -> "Hello ${name}" } // prints nothing, event is skipped
assert 'Groovy' == bean.lang
assert 'Hello Groovy' == bean.sayHello(bean.lang)
```

JN1515-Characters

This page last changed on Aug 30, 2007 by [gavingrover](#).

A Character is a single token from the Unicode basic multilingual plane. It can also convert to the lowermost 16 bits of an integer.

```
assert Character.SIZE == 16 && Character.SIZE == Short.SIZE //16 bits in size
assert Character.MIN_VALUE as int == 0x0000
assert Character.MAX_VALUE as int == 0xFFFF
assert Character.TYPE == char //often, we can write 'char' instead
```

Each Unicode character belongs to a certain category, which we can inspect using `getType()`:

```
def categories= [
'LOWERCASE_LETTER',
//unicode category "Ll": a lowercase letter that has an uppercase variant
'UPPERCASE_LETTER',
//Lu: an uppercase letter that has a lowercase variant
'TITLECASE_LETTER',
//Lt: a letter beginning a word with only the first letter capitalized
'MODIFIER_LETTER',
//Lm: a special character that is used like a letter
'OTHER_LETTER',
//Lo: a letter or ideograph not having lowercase and uppercase variants

'NON_SPACING_MARK',
//Mn: a combining character that doesnt take up space (eg accents, umlauts)
'COMBINING_SPACING_MARK',
//Mc: a combining character that takes up space (eg vowel signs in the East)
'ENCLOSING_MARK',
//Me: an enclosing character (eg circle, square, keycap)

'SPACE_SEPARATOR',
//Zs: an invisible whitespace character that takes up space
'LINE_SEPARATOR',
//Zl: line separator character 0x2028
'PARAGRAPH_SEPARATOR',
//Zp: paragraph separator character 0x2029

'MATH_SYMBOL', //Sm: any mathematical symbol
'CURRENCY_SYMBOL', //Sc: any currency sign
'MODIFIER_SYMBOL',
//Sk: a combining character that's also a full character on its own
'OTHER_SYMBOL',
//So: various other symbols (eg dingbats, box-drawing)

'DECIMAL_DIGIT_NUMBER',
//Nd: a digit zero through nine in any script except ideographic scripts
'LETTER_NUMBER',
//Nl: a number that looks like a letter (eg Roman numerals)
'OTHER_NUMBER',
//No: a superscript or subscript digit, or number that's not a digit 0..9
// (excluding from ideographic scripts)

'DASH_PUNCTUATION', //Pd: any kind of hyphen or dash
'START_PUNCTUATION', //Ps: any kind of opening bracket
'END_PUNCTUATION', //Pe: any kind of closing bracket
'INITIAL_QUOTE_PUNCTUATION', //Pi: any kind of opening quote
'FINAL_QUOTE_PUNCTUATION', //Pf: any kind of closing quote
'CONNECTOR_PUNCTUATION',
//Pc: a punctuation character that connects words (eg underscore)
'OTHER_PUNCTUATION',
//Po: any other kind of punctuation character

'FORMAT', //Cf: invisible formatting indicator
'CONTROL',
```

```

//Cc: 65 ISO control characters (0x00..0x1F and 0x7F..0x9F)
'PRIVATE_USE', //Co: any code point reserved for private non-unicode use
'SURROGATE', //Cs: one half of a surrogate pair
'UNASSIGNED', //Cn: any code point to which no character has been assigned
]

def stats= (0x0000..0xFFFF).groupBy{ Character.getType(it) }
stats.entrySet().sort{ it.value.size }.reverse().each{ cat->
def keyName= Character.fields.
find{ it.get() == cat.key && it.name in categories }.name
println "$keyName: $cat.value.size"
}
}

```

The surrogate category is divided into the high surrogates and the low surrogates. A Unicode supplementary character is represented by two Characters, the first from the high surrogates, the second from the low. Integers, known as code points, can also represent all Unicode characters, including supplementary ones. The code point is the same as a Character converted to an integer for basic plane characters, and its values continue from 0x10000 for supplementary characters. The upper 11 bits of the code point Integer must be zeros. Methods accepting only char values treat surrogate characters as undefined characters.

```

assert Character.MIN_HIGH_SURROGATE == 0xD800 &&
Character.MIN_SURROGATE == 0xD800
assert Character.MAX_HIGH_SURROGATE == 0xDBFF
assert Character.MIN_LOW_SURROGATE == 0xDC00
assert Character.MAX_LOW_SURROGATE == 0xDFFF &&
Character.MAX_SURROGATE == 0xDFFF
assert Character.isSurrogatePair( Character.MIN_HIGH_SURROGATE,
Character.MIN_LOW_SURROGATE )
assert Character.isHighSurrogate( Character.MIN_HIGH_SURROGATE )
assert Character.isLowSurrogate( Character.MIN_LOW_SURROGATE )

assert Character.MIN_CODE_POINT == 0x0000
assert Character.MIN_SUPPLEMENTARY_CODE_POINT == 0x10000 //an integer
assert Character.MAX_CODE_POINT == 0x10FFFF
assert Character.isValidCodePoint( Character.MIN_CODE_POINT )
assert ! Character.isValidCodePoint( Character.MAX_CODE_POINT + 1 )
assert Character.isSupplementaryCodePoint(
Character.MIN_SUPPLEMENTARY_CODE_POINT )
assert ! Character.isSupplementaryCodePoint(
Character.MIN_SUPPLEMENTARY_CODE_POINT - 1 )

assert Character.charCount(0xFFFF) == 1
//number of Characters needed to represent a certain integer as Unicode
assert Character.charCount(0x10FFFF) == 2

assert Character.isDefined(0xFFFD)
assert ! Character.isDefined(0xFFFF) //doesn't include unassigned characters
assert Character.isDefined(0x10000)

```

To convert a Unicode character between a code point and a Character array:

```

def minLowSurr= Character.MIN_LOW_SURROGATE,
maxLowSurr= Character.MAX_LOW_SURROGATE,
minHighSurr= Character.MIN_HIGH_SURROGATE,
maxHighSurr= Character.MAX_HIGH_SURROGATE
assert Character.toChars(0xFFFF).collect{ it as int }.toList() == [0xFFFF]
//convert integer into array of Characters
assert Character.toChars(0x10000).collect{ it as int }.toList() ==
[minHighSurr as int, minLowSurr as int]
assert Character.toChars(0x10FFFF).collect{ it as int }.toList() ==
[maxHighSurr as int, maxLowSurr as int]

def charArray= new char[6] //an array that can only contain Characters
assert Character.toChars(0x10000, charArray, 2) == 2 &&
charArray.collect{ it as int }.toList() ==

```

```
[0, 0, minHighSurr as int, minLowSurr as int, 0, 0]
charArray= new char[4]
assert Character.toChars(0xFFFF, charArray, 1) == 1 &&
charArray.collect{ it as int }.toList() == [0, 0xFFFF, 0, 0]

assert Character.toCodePoint(minHighSurr, minLowSurr) == 0x10000
//converts surrogate pair to integer representation
```

We can enquire of code points in a char array or string:

```
def minLowSurr= Character.MIN_LOW_SURROGATE,
minHighSurr= Character.MIN_HIGH_SURROGATE

def ca1= ['a', 'b', 'c', minHighSurr, minLowSurr, 'e', 'f', 'g'] as char[]
def ca2= ['a', 'b', 'c', 0xFFFF, 'e', 'f', 'g'] as char[]
assert Character.codePointAt(ca1, 3) == 0x10000
//beginning at index 3, look at as many chars as needed
assert Character.codePointAt(ca2, 3) == 0xFFFF
assert Character.codePointAt(ca1, 3, 4) == minHighSurr
//extra parameter limits sequence of chars to index <4
assert Character.codePointAt(ca2, 3, 4) == 0xFFFF
assert Character.codePointBefore(ca1, 4) == minHighSurr
assert Character.codePointBefore(ca1, 5) == 0x10000
//if low surrogate, look back more for high one, and use both
assert Character.codePointBefore(ca1, 5, 4) == minLowSurr
//extra param limits lookback to index >=4
assert Character.codePointCount(ca1, 1, 5) == 4
//number of code points in a subarray given by offset 1 and count 5
assert Character.codePointCount(ca1, 1, 4) == 3
//lone high surr counted as 1 code point
assert Character.offsetByCodePoints(ca1, 0, 6, 1, 3) == 5
//index of ca1[0..<6] that's offset by 3 code points

//versions of these methods exist for strings...
def s1= 'abc'+ minHighSurr + minLowSurr + 'efg'
def s2= 'abcdefg'
assert Character.codePointAt(s1, 3) == 0x10000
//if high surrogate, add on low surrogate
assert Character.codePointAt(s1, 4) == minLowSurr
//if low surrogate, use it only
assert Character.codePointAt(s1, 5) == 'e' as int
assert Character.codePointAt(s2, 3) == 'd' as int
//enquire code point in string
assert Character.codePointBefore(s1, 4) == minHighSurr
assert Character.codePointBefore(s1, 5) == 0x10000
//if low surrogate, look back more for high one, and use both
assert Character.codePointCount(s1, 1, 5) == 3
//number of code points in a substring with indexes >=1 and <5
assert Character.offsetByCodePoints(s1, 1, 3) == 5
//index from 1 that's offset by 3 code points
```

Every character also has a directionality:

```
def directionalities= [:]
Character.fields.each{
if( it.name =~ /^DIRECTIONALITY_/ ) directionalities[ it.get() ]= it.name
}

def stats= (0x0000..0xFFFF).groupBy{ Character.getDirectionality(it) }
//will also work for supplementary chars
stats.entrySet().sort{ it.value.size }.reverse().each{ dir->
def keyName= Character.fields.
find{ it.get() == dir.key && it.name in directionalities.values() }.name
println "$keyName: $dir.value.size"
}
}
```

Every character is part of a Unicode block:

```

(0x0000..0xFFFF).groupBy{ Character.UnicodeBlock.of( it as char ) }.
entrySet().sort{it.value.size}.reverse().
each{ println "$it.key: $it.value.size" } //this uses basic plane only

//this one uses supplementary characters also...
(0x0000..0x10FFFF).groupBy{ Character.UnicodeBlock.of( it as int ) }.
entrySet().sort{it.value.size}.reverse().
each{ println "$it.key: $it.value.size" }

try{ Character.UnicodeBlock.of( 0x110000 ); assert 0 }
catch(e){ assert e instanceof IllegalArgumentException }

```

Character assists integers using different radices:

```

assert Character.MIN_RADIX == 2
//the minimum and maximum radices available for conversion to/from strings
assert Character.MAX_RADIX == 36 //0 to 9, and A to Z
assert Character.forDigit(12, 16) == 'c'
//character representation for a digit in a certain radix
assert Character.digit('c' as char, 16) == 12
//digit of a character rep'n in a certain radix

```

We can find the Unicode block for a loosely-formatted textual description of it:

```

[ 'BASIC LATIN', 'basic latin', 'BasicLatin', 'baSicLaTin', 'BaSiC LaTiN',
'BASIC_LATIN', 'BaSiC_LaTiN' ].
each{ assert Character.UnicodeBlock.forName(it).toString() == 'BASIC_LATIN' }

```

Constructing and Using Characters

We can't represent Characters directly in our programs, but must construct them from a string:

```

assert 'a'.class == String
def c1= 'a' as char, c2= (char)'b' //constructing
def c3= new Character(c2), c4= c2.charValue() //cloning
[c1, c2, c3, c4].each{ assert it.class == Character }
assert c2 == c3 && c1 != c2
assert c1 < c2 && c1.compareTo(c2) == -1
//comparing works just the same as for numbers
assert c2.toString().class == String

```

There's a number of Character utility methods, accepting either a code point or a basic-plane character, that test some attribute of the character:

```

def categories= [
'digit': { Character.isDigit(it) },
'letter': { Character.isLetter(it) },
'letter or digit': { Character.isLetterOrDigit(it) },
'identifier ignorable': { Character.isIdentifierIgnorable(it) },
//an ignorable character in a Java or Unicode identifier
'ISO control': { Character.isISOControl(it) }, //an ISO control character
'Java identifier part': { Character.isJavaIdentifierPart(it) },
//be part of a Java identifier as other than the first character
'Java identifier start': { Character.isJavaIdentifierStart(it) },
//permissible as the first character in a Java identifier
'Unicode identifier part': { Character.isUnicodeIdentifierPart(it) },
//be part of a Unicode identifier other than first character
'Unicode identifier start': { Character.isUnicodeIdentifierStart(it) },
//permissible as first character in a Unicode identifier
'lower case': { Character.isLowerCase(it) },
'upper case': { Character.isUpperCase(it) },
'title case': { Character.isTitleCase(it) },
'space char': { Character.isSpaceChar(it) }, //a Unicode space character
'whitespace': { Character.isWhitespace(it) }, //white space according to Java
'mirrored': { Character.isMirrored(it) },
//mirrored according to the Unicode spec

```

```

]
def stats= [:]
categories.keySet().each{ stats[it]= 0 }
(0x0000..0xFFFF).each{ch-> //also works with supplementaries (0x0000..0x10FFFF)
categories.each{cat->
if( cat.value(ch) ) stats[ cat.key ] += 1
}
}
stats.entrySet().sort{ it.value }.reverse().each{ println "$it.key: $it.value" }

```

We can use characters instead of numbers in arithmetic operations:

```

assert 'a' as char == 97 && 'd' as char == 100
assert ('a' as char) + 7 == 104 && 7 + ('a' as char) == 104
//either first or second arg
assert ('a' as char) + ('d' as char) == 197 //two chars
assert ('a' as char).plus(7) == ('a' as char) + 7 //alternative method name
assert ('a' as char) - 27 == 70 && ('a' as char).minus(27) == 70
assert ('a' as char) * ('d' as char) == 9700 &&
('a' as char).multiply('d' as char) == 9700
assert 450 / ('d' as char) == 4.5 && 450.div('d' as char) == 4.5
assert 420.intdiv('d' as char) == 4

assert ('a' as char) > 90 && ('a' as char).compareTo(90) == 1
assert 90 < ('a' as char) && 90.compareTo('a' as char) == -1
assert ('a' as char) == ('a' as char) &&
('a' as char).compareTo('a' as char) == 0

```

We can auto-increment and -decrement characters:

```

def c= 'p' as char
assert c++ == 'p' as char && c == 'q' as char &&
c-- == 'q' as char && c == 'p' as char &&
++c == 'q' as char && c == 'q' as char &&
--c == 'p' as char && c == 'p' as char
assert c.next() == 'q' && c.previous() == 'o' && c == 'p'

```

Some miscellaneous methods:

```

assert Character.getNumericValue('6' as char) == 6
assert Character.reverseBytes(0x37ae as char) == 0xae37 as char

assert Character.toUpperCase('a' as char) == 'A' as char
assert Character.toLowerCase('D' as char) == 'd' as char
assert Character.titleCase('a' as char) == 'A' as char

```

JN1525-Strings

This page last changed on Aug 30, 2007 by [gavingrover](#).

We can use either single- or double-quotes around strings:

```
assert 'hello, world' == "hello, world"
assert "Hello, Groovy's world" == 'Hello, Groovy\'s world'
//backslash escapes the quote
assert 'Say "Hello" to the world' == "Say \"Hello\" to the world"
```

Backslashes can escape other characters in Strings. We can use letter codes (eg '\b') or octal codes (eg '\010'):

```
assert '\b' == '\010' //backspace
assert '\t' == '\011' //horizontal tab
assert '\n' == '\012' //linefeed
assert '\f' == '\014' //form feed
assert '\r' == '\015' //carriage return
assert '\\ ' == '\\ ' //use backslash to escape the backslash
```

To span multiple lines, use either triple quotes or a backslash at the end of the continuing lines to join them with the next:

```
assert '''hello,
world''' == 'hello,\nworld'
//triple-quotes for multi-line strings, adds '\n' regardless of host system
assert 'hello, \
world' == 'hello, world' //backslash joins lines within string
```

We can also use three double-quotes.

```
def text = """\
Good morning.
Good night again."""
```

When using double-quotes, either one or three, we can embed code within them using \$. Here, they're called GStrings:

```
def name = 'Groovy'
assert "hello $name, how are you today?" == "hello Groovy, how are you today?"
```

Anything more complex than a variable name must be surrounded by curlies:

```
def a = 'How are you?'
assert "The phrase '$a' has length ${a.size()}" ==
"The phrase 'How are you?' has length 12"
```

We can change the variable's value in the GString:

```
def i= 1, list= []
3.times{ list<< "${i++}" }
assert list.join() == '123'
```

String methods

We can convert other objects in Groovy to their string representation in different ways:

```
def o= new Object()
assert String.valueOf( o ) == o.toString() //this works for any object in Groovy
assert String.valueOf( true ) == true.toString() //boolean value
assert String.valueOf( 'd' as char ) == ('d' as char).toString() //character
assert String.valueOf( 7.5d ) == 7.5d.toString() //double
assert String.valueOf( 8.4f ) == 8.4f.toString() //float
assert String.valueOf( 13i ) == 13i.toString() //integer
assert String.valueOf( 14L ) == 14L.toString() //long
assert String.valueOf( ['a', 'b', 'c'] ) == ['a', 'b', 'c'].toString()
//list, etc, etc, etc
```

To find the size and substrings:

```
def s= 'abcdefg'
assert s.length() == 7 && s.size() == 7
assert s.substring(2,5) == 'cde' && s.substring(2) == 'cdefg'
assert s.subSequence(2,5) == 'cde'
```

There's different ways to construct a string:

```
assert new String() == ''
assert new String('hello') == 'hello'

def minLowSurr= Character.MIN_LOW_SURROGATE,
minHighSurr= Character.MIN_HIGH_SURROGATE
def str= 'abc' + minHighSurr + minLowSurr + 'efg'
def ca= ['a', 'b', 'c', minHighSurr, minLowSurr, 'e', 'f', 'g'] as char[]
def ia= ['a', 'b', 'c', 0x10000, 'e', 'f', 'g'] as int[]
assert new String(ca) == str
assert new String(ca, 2, ca.size()-2) == str[2..-1]
assert new String(ia, 2, ia.size()-2) == str[2..-1]

def ca2= new char[8]
str.getChars(0, str.size(), ca2, 0)
//copy characters from string into character array
assert ca2.size() == str.size()
ca2.forEachWithIndex{ elt, i-> assert elt == str[i] }

def ca3= ['a', 'b', 'c', 'd', 'e'] as char[]
'abcde'.toArray().forEachWithIndex{ it, i-> assert it == ca3[i] }
//convert String to char array
assert String.valueOf(ca3) == 'abcde' //convert char array to String
assert String.copyValueOf(ca3) == 'abcde' //alternative method name
assert String.valueOf(ca3, 2, 2) == 'cd' //use substring
assert String.copyValueOf(ca3, 2, 2) == 'cd'
```

We can pad and center strings:

```
assert 'hello'.padRight(8,'+').padLeft(10,'+') == '++hello+++'
assert 'hello'.padLeft(7).padRight(10) == ' hello  '
assert 'hello'.center(10, '+').center(14, ' ') == ' ++hello+++ '
```

We can split a string into tokens:

```
assert 'he she\t it'.tokenize() == ['he', 'she', 'it']
//tokens for split are '\t\n\r\f'
assert 'he she\t it'.tokenize() ==
new StringTokenizer('he she\t it').collect{ it }

assert 'he,she;it,;they'.tokenize(',') == ['he', 'she', 'it', 'they']
//supply our own tokens
assert new StringTokenizer('he,she;it,;they', ',;').collect{ it } ==
'he,she;it,;they'.tokenize(',')

assert new StringTokenizer('he,she,;it', ',;', true).collect{ it } ==
['he', ',', 'she', ',', ';', 'it']
//long form provides extra option to return the tokens with the split-up data
```

Some additional methods:

```
assert 'abcde'.find{ it > 'b' } == 'c' //first one found
assert 'abcde'.findAll{ it > 'b' } == ['c', 'd', 'e'] //all found
assert 'abcde'.indexOf{ it > 'c' } == 3 //first one found

assert 'abcde'.every{ it < 'g' } && ! 'abcde'.every{ it < 'c' }
assert 'abcde'.any{ it > 'c' } && ! 'abcde'.any{ it > 'g' }

assert 'morning'.replace('n','t') == 'mortitg' &&
```

```

'boo'.replace('o', 'at') == 'batat' &&
'book'.replace('oo','ie') == 'biek'

assert 'EggS'.toLowerCase() == 'eggs' && 'EggS'.toUpperCase() == 'EGGS'
assert '   Bacon   '.trim() == 'Bacon'
assert 'noodles'.startsWith('nood') && 'noodles'.endsWith('dles')
assert 'corn soup'.startsWith('\r\n', 2) //2 is offset

assert 'abc'.concat('def') == 'abcdef'
assert 'abcdefg'.contains('def')
assert ''.isEmpty() && !'abc'.isEmpty()

assert 'morning'.indexOf('n') == 3
assert 'morning'.indexOf('n', 4) == 5 //ignore first 4 characters
assert 'morning'.indexOf('ni') == 3
assert 'morning'.indexOf('ni', 4) == -1 //not found
assert 'morning'.lastIndexOf('n') == 5
assert 'morning'.lastIndexOf('n', 4) == 3 //only search first 4 characters
assert 'morning'.lastIndexOf('ni') == 3
assert 'morning'.lastIndexOf('ni', 4) == 3
//only search first 4 characters for first char of search string

```

We can use operators on strings:

```

assert 'hello, ' + 'balloon' - 'lo' == 'hel, balloon'
// '-' subtracts one instance at most of string
assert 'hello, balloon' - 'abc' == 'hello, balloon'
assert 'hello, '.plus('balloon').minus('lo') == 'hel, balloon'
//alternative method syntax
assert 'value is ' + true == 'value is true' &&
'value is ' + 1.54d == 'value is 1.54' &&
//first converts double to String (without info loss)
'value is ' + 7 == 'value is 7' //we can add on various types of values
assert 7 + ' is value' == '7 is value'
assert 'telling true lies' - true == 'telling lies' &&
'week has 7 days' - 7 == 'week has days'
//we can subtract various types of values
assert 'a' * 3 == 'aaa' && 'a'.multiply(3) == 'aaa'

assert 'hello'.reverse() == 'olleh'
assert 'hello'.count('l') == 2

assert 'abc'.collect{ it * 2 } == ['aa', 'bb', 'cc']
def s= [], t= [:]
'abc'.each{ s << it }
'abc'.eachWithIndex{ elt, i-> t[i]= elt }
assert s == ['a', 'b', 'c'] && t == [0:'a', 1:'b', 2:'c']
assert 'abcde'.toList() == ['a', 'b', 'c', 'd', 'e']

assert 'abc'.next() == 'abd' && 'abc'.previous() == 'abb'

```

We can subscript strings just as we can lists, except of course strings are read-only:

```

assert 'abcdefg'[ 3 ] == 'd'
assert 'abcdefg'.getAt( 3 ) == 'd' //equivalent method name
assert 'abcdefg'.charAt( 3 ) == 'd' //alternative method name
assert 'abcdefg'[ 3..5 ] == 'def'
assert 'abcdefg'.getAt( 3..5 ) == 'def'
assert 'abcdefg'[ 1, 3, 5, 6 ] == 'bdfg'
assert 'abcdefg'[ 1, *3..5 ] == 'bdef'
assert 'abcdefg'[ 1, 3..5 ] == 'bdef'
//range in subscript flattened automatically
assert 'abcdefg'[-5..-2] == 'cdef'
assert 'abcdefg'.getAt( [ 1, *3..5 ] ) == 'bdef'
assert 'abcdefg'.getAt( [ 1, 3..5 ] ) == 'bdef'

assert 'abcde' == 'ab' + 'c' + 'de'

```

```

assert 'abcde'.equals('ab' + 'c' + 'de') //equivalent method name
assert 'abcde'.contentEquals('ab' + 'c' + 'de') //alternative method name
assert 'AbcdE'.equalsIgnoreCase('aBCDe')
assert 'abcde' < 'abcdf' && 'abcde' < 'abcdef'
assert 'abcde'.compareTo('abcdf') == -1 && 'abcde'.compareTo('abcdef') == -1
//equivalent method
assert 'AbcdEF'.compareToIgnoreCase('aBCDe') == 1
assert 'AbcdE'.compareToIgnoreCase('aBCDef') == -1

assert Collections.max( 'abc'.toList(), String.CASE_INSENSITIVE_ORDER ) == 'C'
assert Collections.min(
['abc', 'ABd', 'AbCd'], String.CASE_INSENSITIVE_ORDER ) == 'abc'

assert 'abcde'.regionMatches(2, 'cccd', 3, 2)
//match from index 2 in 'abcde' to 2 chars from index 3 in 'cccd'
assert 'abcDE'.regionMatches(true, 2, 'CCCD', 3, 2)
//if first arg is true, ignores case

```

We can format values into a string, using `format()`:

```

//Strings (conversion type 's')
assert String.format('%1$8s', 'hello') == '   hello'
//width (here, 8) is minimum characters to be written
assert String.format('%2$6s,%1$2s', 'a', 'hello') == ' hello, a'
//we can re-order arguments
assert String.format('%1$2s', 7, 'd') == ' 7'
//we can give any type of input; we can ignore arguments
assert String.format('%1s,%2s', null, 'null') == 'null,null'
//null treated as 'null'
assert String.format('%1$2.4s', 'hello') == 'hell'
//precision (here, 4) is maximum characters to be written

//Characters ('c')
assert String.format('%1$c,%2$3c', 65, 66 as byte) == 'A,  B'
//convert argument to character; 2nd value 3 chars wide
assert String.format('%-3c', 67 as short) == 'C  '
//left-justified with '-' flag; we needn't specify parameter number (1$, etc)
assert String.format('%c', 'D' as char) == 'D'

//Special conversion types:
assert String.format('hello %n world %%)') == 'hello \r\n world %'
//platform-specific newline; double % to quote it

//Boolean ('b')
assert String.format('%b, %b, %b, %b, %b, %b',
null, true, false, 0, 1, new Object()) ==
'false, true, false, true, true, true'

```

StringBuffers

A `StringBuffer` is a mutable string. (But from Java 5.0 onwards, we should use a `StringBuilder` instead, because `StringBuffers` are normally reserved for multi-threaded processing.)

```

def sb1= new StringBuffer(),
sb2= new StringBuffer('Hello'),
sb3= new StringBuffer(sb2)
assert sb1.toString() == '' &&
sb2.toString() == 'Hello' &&
sb2.toString() == sb3.toString()

```

To find the size and substrings:

```

def sb= new StringBuffer('abcdefg')
assert sb.size() == 7 && sb.length() == 7 //different ways to find size
sb.length= 6 //change size
assert sb.toString() == 'abcdef'

```

```

assert sb.reverse().toString() == 'fedcba'
assert sb.toString() == 'fedcba' //reverse() method reverses order permanently
assert sb.substring(2) == 'dcba' //substring from index 2
assert sb.substring(2, 5) == 'dcb' //substring from index 2 to <5
assert sb.subSequence(2, 5) == 'dcb' //substring from index 2 to <5
assert sb + 'zyx' == 'fedcbazyx'

```

To append to a StringBuffer:

```

def sb1= new StringBuffer()
sb1 << 'abc'
sb1 << 'def' << 'ghi' //can chain two << operators
sb1.leftShift('jkl') //equivalent method name
sb1.append('mno') //alternative method name
sb1.append( ['p', 'q', 'r'] as char[] )
sb1.append( ['r', 's', 't', 'u', 'v'] as char[], 1, 3 )
assert sb1.toString() == 'abcdefghijklmnopqrstu'

```

Note that << doesn't yet work with StringBuilders.

If we append to a String, a StringBuffer is returned:

```

def s= 'foo'
s= s << 'bar'
assert s.class == StringBuffer && s.toString() == 'foobar'

```

As with strings, we can subscript a StringBuffer, returning a string:

```

def sb= new StringBuffer('abcdefg')
assert sb[ 3 ] == 'd'
assert sb[ 3 ].class == String
assert sb.getAt( 3 ) == 'd' //equivalent method name
assert sb.charAt( 3 ) == 'd' //alternative method name
assert sb[ 3..5 ] == 'def'
assert sb[ 1, 3, 5, 6 ] == 'bdfg'
assert sb[ 1, 3..5 ] == 'bdef'
assert sb[-5..-2] == 'cdef'
sb[ 3..5 ] = 'xy' //use subscripts to update StringBuffer
assert sb.toString() == 'abcxyg'
sb.putAt( 2..4, 'z' ) //equivalent method name
assert sb.toString() == 'abzg'
sb.setCharAt(1, 'm' as char) //alternative method name
assert sb.toString() == 'amzg'

```

We can insert into, replace within, and delete from StringBuffers using methods:

```

def sb= new StringBuffer('hello park')
sb.delete(4, 7)
assert sb.toString() == 'hellark'
sb.deleteCharAt(3)
assert sb.toString() == 'helark'
def ca= new char[6]
sb.getChars(2, 5, ca, 1)
//for indexes 2 to <5, copy into ca beginning from index 1
(['\0', 'l', 'a', 'r', '\0', '\0'] as char[]).
eachWithIndex{ elt, i-> assert ca[i] == elt }

sb.insert(4, 'se')
assert sb.toString() == 'helaserk'
sb.insert(4, new StringBuffer('ct '))
assert sb.toString() == 'helact serk'
sb.insert(10, ['i', 'c'] as char[] )
assert sb.toString() == 'helact serick'
sb.insert(6, ['m', 'a', 'l', 't'] as char[], 1, 2)
//insert 2 chars from subscript 1
assert sb.toString() == 'helactal serick'
sb.insert(10, 'snapla', 3, 5) //insert chars from subscript 3 to <5

```

```

assert sb.toString() == 'helactal splerick'
sb.replace(4, 13, 'dor') //replace chars from subscript 4 to <13
assert sb.toString() == 'heladorrick'

```

We can find the index of substrings:

```

def sb= new StringBuffer('hello elm')
assert sb.indexOf('el') == 1
assert sb.indexOf('el', 3) == 6 //first occurrence of 'el' from index 3
assert sb.lastIndexOf('el') == 6
assert sb.lastIndexOf('el', 3) == 1 //last occurrence of 'el' up to index 3

```

Some miscellaneous methods:

```

def s= new String( new StringBuffer('abcdefg') )
assert s == 'abcdefg'
assert s.contains('def')
assert s.contentEquals('abcdefg')
assert s.contentEquals( new StringBuffer('abcdefg') )
def s2= s.replace('def', 'xyz')
assert s2 == 'abcxyzg'

```

We can enquire of code points in a String or StringBuffer using methods on them, just as we can with methods on Character:

```

def minLowSurr= Character.MIN_LOW_SURROGATE,
minHighSurr= Character.MIN_HIGH_SURROGATE

def s1= 'abc'+ minHighSurr + minLowSurr + 'efg'
assert s1.codePointAt(3) == 0x10000 //if high surrogate, add on low surrogate
assert s1.codePointAt(4) == minLowSurr //if low surrogate, use it only
assert s1.codePointAt(5) == 'e' as int
assert s1.codePointBefore(4) == minHighSurr
assert s1.codePointBefore(5) == 0x10000
//if low surrogate, look back more for high one, and use both
assert s1.codePointCount(1, 5) == 3
//number of code points in a substring with indexes >=1 and <5
assert s1.offsetByCodePoints(1, 3) == 5
//index from 1 that's offset by 3 code points

def sb= new StringBuffer( 'abc'+ minHighSurr + minLowSurr + 'efg' )
//also, for StringBuffers
assert sb.codePointAt(5) == 'e' as int
assert sb.codePointBefore(4) == minHighSurr
assert sb.codePointCount(1, 5) == 3
assert sb.offsetByCodePoints(1, 3) == 5

sb.appendCodePoint(0x10000)
assert sb.toString() ==
'abc'+ minHighSurr + minLowSurr + 'efg'+ minHighSurr + minLowSurr

```

We can manipulate the implementation of a StringBuffer:

```

def sb1= new StringBuffer() //default initial capacity is 16
assert sb1.capacity() == 16

def sb2= new StringBuffer(5) //we can specify initial capacity
assert sb2.capacity() == 5
sb2<< 'abc'
assert sb2.capacity() == 5 && sb2.size() == 3
sb2.trimToSize()
assert sb2.capacity() == 3
sb2.ensureCapacity(10)
assert sb2.capacity() == 10

def sb3= new StringBuffer(0) //capacity approximately doubles when required
def cap= 0, caps=[]

```

```
100.times{
  if((sb3<< 'a').capacity() != cap) caps<< (cap= sb3.capacity())
}
assert caps == [2, 6, 14, 30, 62, 126]
```

JN1535-Patterns

This page last changed on Aug 30, 2007 by [gavingrover](#).

Matching Strings to Patterns

We can define string patterns, aka "Regular Expressions" or "Regexes", and see if a String matches it:

```
assert 'abc' ==~ /abc/ //pattern on righthand side between single-slashes
assert ! ( 'abc' ==~ /ace/ )
assert ! ( 'abc' ==~ /ab/ )

assert 'abc' ==~ /a.c/
//the . in the pattern matches any character, except \n (or \r\n on Windows)
assert 'abc'.matches( /a.c/ ) //alternative method name
assert java.util.regex.Pattern.matches( /a.c/, 'abc' ) //alternative syntax
assert java.util.regex.Pattern.compile( /a.c/ ).matcher( 'abc' ).matches()
//alternative syntax

assert '\t\n\f\r' ==~ /\t\n\f\r/
//some control chars have same notation as in strings
assert '\t\n\f\r' ==~ /\x09\x0a\x0c\x0D/
//alternatively use hex codes (leading zero required to make 2 digits)
assert '\t\n\f\r' ==~ /\011\012\014\015/
//alternatively use octal codes (leading zero required)
assert '\b' ==~ /\x08/ && ! ( '\b' ==~ /\b/ )
// \b has different meaning in regex than in string
assert '\07\013\033' ==~ /\a\v\e/
//regex-only notation: bell \a, vertical tab \v, escape \e
```

Twelve characters that are special syntax for regexes need to be quoted:

```
assert 'a.c' ==~ /a.c/ //backslash before . to quote it
assert '.{[()\\^$|?*+}' ==~ /\.\\{[()\\(\\)\\^\\$|\\?\\*\\+\\/
//the 12 chars that need quoting
assert '.{[()\\^$|?*+}' ==~ /Q.{[()\\^$|?*+}E/
//another way to quote text is to bracket with \Q and \E
import java.util.regex.Pattern
assert Pattern.quote( /\.{[()\\^$|?*+}/ ) == /Q.{[()\\^$|?*+}E/
//a special method to quote text in this way
```

The chars `\c@`, `\cA`, `\cB`, ..., `\cZ`, `\c[`, `\c]`, `\c^`, and `\c_` map to the special characters 0x0 to 0x1f, except 0x1c:

```
assert "${0x0 as char}" ==~ /\c@/
for(int c= 'A'; int d= 0x1; c <= 'Z'; c++; d++){
  assert "${d as char}" ==~ /\c${c as char}/
}
assert "${0x1b as char}" ==~ /\c[/
assert "${0x1d as char}" ==~ /\c[/
assert "${0x1e as char}" ==~ /\c^/
assert "${0x1f as char}" ==~ /\c_
```

We have special pattern syntax for whitespace `\s`, word characters `\w`, digits `\d`, and their complements:

```
assert (0x0..0x7F).findAll{ (it as char) ==~ /\s/ } ==
['\t', '\n', '\013', '\f', '\r', ' '].collect{it as int}
assert (0x0..0x7F).findAll{ (it as char) ==~ /\w/ } ==
['*0'..'9', '*A'..'Z', '_', '*a'..'z'].collect{it as int}
assert (0x0..0x7F).findAll{ (it as char) ==~ /\d/ } ==
('0'..'9').collect{it as int}

[ [/\w/, /\W/], [/\d/, /\D/], [/\s/, /\S/] ].each{ pair->
  assert (0x0..0x7F).findAll{ (it as char) ==~ pair[0] &&
(it as char) ==~ pair[1] }.size() == 0
} // \S means not \s; \W means not \w; \D means not \d
```

There's certain characters that the dot . doesn't match, except when (?s) is used:

```
assert (0x0..0x7F).findAll{ !( (it as char) ==~ /. / ) } ==
['\n' as int, '\r' as int]
//chars that . doesn't match //also: 0x85, 0x2028, 0x2029
assert 'abc\ndef' ==~ /a.c\ndef/
assert !( 'abc\ndef' ==~ /abc.def/ ) //the . doesn't match \n

assert (0x0..0x7F).findAll{ !( (it as char) ==~ /(?!s). / ) } == []
//when (?s) used, . matches every character
assert 'abc\r\ndef' ==~ /(?!s)abc..def/ && !( 'abc\r\ndef' ==~ /(?!s)abc.def/ )
//on Windows, \r\n needs .. for match

assert (0x0..0x7F).findAll{ !( (it as char) ==~ /(?!d). / ) } == ['\n' as int]
//only char that . doesn't match for (?d) flag
assert (0x0..0x7F).findAll{ !( (it as char) ==~ /(?!sd). / ) } == []
// (?sd) together same as (?s) alone
```

Some other flags:

```
assert ( 'gOoDbYe' ==~ /(?!i)goodbye/ )
//when (?i) used, case-insensitive matching for ASCII characters

assert 'an ace' ==~ /(?!x) an\ ace #comment here after hash/
//quote the space, ignore unquoted whitespace and comments
```

Some other ways to use flags:

```
assert 'abcDEFG' ==~ /abc(?!i)defg/
//turn on flag halfway thru pattern
assert 'abCDefg' ==~ /ab(?!i)cd(?-i)efg/
//turn flag on, then off again
assert 'abCDEfg' ==~ /ab(?!i:cde)fg/
//turn flag on for only a certain span of text
assert 'ABcdeFG' ==~ /(?!i)ab(?-i:cde)fg/
//turn flag on, but off for only a certain span

assert 'abcdefg' ==~ /abc(?!ix) d e f g #comment here/
//turn more than one flag on together
assert 'abcdefg' ==~ /(?!ix) a b c (?-ix)defg/
//turn more than one flag off together
assert 'abcdefg' ==~ /(?!ix) a b c (?s-ix)defg/
//turn some flag(s) on and other flag(s) off together

import java.util.regex.Pattern
assert Pattern.compile(/abc.def/, Pattern.DOTALL).matcher('abc\ndef').matches()
//alternative to (?s)
assert ! Pattern.compile(/abc.def/, Pattern.UNIX_LINES).
matcher('abc\ndef').matches() //alternative to (?d)
assert Pattern.compile(/goodbye/, Pattern.CASE_INSENSITIVE).
matcher('gOoDbYe').matches() //alternative to (?i)
assert Pattern.compile(/ an\ ace #comment here/, Pattern.COMMENTS).
matcher('an ace').matches() //alternative to (?x)

//we can enquire the flags set at the end-point of a pattern...
import java.util.regex.Pattern
assert Pattern.compile(/ab(?!i)c.def/, Pattern.DOTALL).flags() ==
Pattern.DOTALL + Pattern.CASE_INSENSITIVE
assert Pattern.compile(/ab(?!i)c.d(?-i)ef/, Pattern.DOTALL).flags() ==
Pattern.DOTALL
assert Pattern.compile(/ab(?!i:c)d.ef/, Pattern.DOTALL).flags() ==
Pattern.DOTALL
```

A character class is a set of characters, one of which may be matched. We've already seen the predefined character classes `\s`, `\w`, `\d`, `\S`, `\W`, `\D`. We can also define our own:

```
['bat', 'bet', 'bit', 'bot', 'but'].each{ assert it ==~ /b[aeiou]t/ }
```



```

//[aeiou] matches one of a,e,i,o,u
assert ! ('bnt' ==~ /b[aeiou]t/)

['bat', 'bet', 'bit', 'bot', 'but'].each{ assert ! (it ==~ /b[^aeiou]t/) }
//[^aeiou] matches anything except a,e,i,o,u...
['bbt', 'bxt', 'b%t', 'b)t', 'b*t', 'b\nt'].each{ assert it ==~ /b[^aeiou]t/ }
//...even newlines

assert 'b' ==~ /[abbbc]/ //duplicate chars in character class have no effect
assert '&' ==~ /[a&]/ &&
!('&' ==~ /[a&&z]/) &&
'&' ==~ /[a&&&]/ &&
!('&' ==~ /[a&&]/) &&
'&' ==~ /[a&\&]/ //all legal syntax

[ /[a-j]/: ['a'..'j'],
//we can specify a range of characters inside a class using hyphen -
/[_a-zA-Z]/: ['A'..'Z', '_', '*a'..'z'],
//we can have many ranges mixed with single characters
/[_a-zA-Z]/: ['A'..'Z', '_', '*a'..'z'],
//same effect as [_a-zA-Z]
/[a-m&g-z]/: ['g'..'m'],
//&& is intersection operator
/[a-z&[^bc]]/: ['a', '*d'..'z'],
//^ means 'not' everything in the character class
/[a-z&[^m-p]]/: ['a'..'l', '*q'..'z'],
//&& with ^ works like subtraction
/[^\d\s]/: [*0x0..0x7F].collect{ it as char } - ['\t'..'r', ' ', '*0'..'9'],
//not digit AND not whitespace
/[^\D\S]/: [*0x0..0x7F].collect{ it as char },
//not equal to above, but means: not digit OR not whitespace
].each{ regex, validVals->
assert (0x0..0x7F).findAll{ (it as char) ==~ regex } ==
validVals.collect{ it as int }
}

```

The only meta-characters inside a character class are \, [, ^ (in the first position),] (not in the first position or after the ^), - (not in the first position, after the ^, or before the]), and &&. Quote them with a / to get the literal character. The other usual meta-characters are normal characters inside a character class, and do not need to be quoted with a backslash, though can be. Character class precedences are, from highest: literal escapes (eg \s), grouping (eg [abc]), ranges (eg a-g), unions (eg [abc][xyz]), then intersections ([a-z&[gjpqy]]).

We can use the alternation operator | to give some options:

```

['abc', 'def', 'xyz'].each{ assert it ==~ /abc|def|xyz/ }
['abcz', 'aijz', 'axyz'].each{ assert it ==~ /a(bc|ij|xy)z/ }
//we delimit the alternation with parentheses

//when using longhand syntax, we can see what option was matched, using groups,
//which we'll meet soon:
def m= java.util.regex.Pattern.compile( /a(bc|ij|xy)z/ ).matcher( 'abcz' )
m.matches()
assert m.group(1) == 'bc' //whatever was matched between the parens

```

We use ? to indicate optional character/s:

```

['0 days', '1 day', '2 days'].each{ assert it ==~ /. days?/ }
['Mon', 'Monday'].each{ assert it ==~ /Mon(day)?/ }

```

Use {n} to match a character exactly n times:

```

assert 'aaab' ==~ /a{3}b/
assert 'abcabc' ==~ /(abc){2}/ // {n} can apply to a multi-character sequence
['ab', 'ba', 'bb', 'aa'].each{ it ==~ /[ab]{2}/ }
// {n} can apply to a character class
['abab', '%&@b'].each{ assert it ==~ /.{3}b/ }

```

We can match a character a variable number of times. Use the * operator to match any number of a character:

```
['aaab', 'aab', 'ab', 'b'].each{ assert it =~ /a*b/ }
//even zero occurrences of the character is matched
['abcabc', 'abc', ''].each{ assert it =~ /(abc)*/ }
// * can apply to a multi-character sequence
['abbacb', 'acaba', 'cbbbac', 'c', ''].each{ assert it =~ /[abc]*/ }
// * can apply to a character class
['aaab', 'b', 'abab'].each{ assert it =~ /.*/ }
// * is greedy: in 'abab' .* matches 'aba'

//Use + to match at least one occurrence of a character:
['aaab', 'aab', 'ab'].each{ assert it =~ /a+b/ }
assert !( 'b' =~ /a+b/ ) //at least one 'a' is required
assert 'abcabcxz' =~ /(abc)+[xyz]+/
// + can apply to character class or multi-character sequence

//Other variable-length repetition operators:
assert 'aaaab' =~ /a{3,}b/ // {n,} matches at least n characters
assert 'aaaab' =~ /a{3,5}b/ // {n1,n2} matches between n1 and n2 characters
assert 'abaxyzxyz' =~ /[ab]{2,}(xyz){2,4}/
//these also can apply to multi-character sequences or character classes
```

By using longhand syntax, we see that * operator is greedy, repeating the preceding token as often as possible, returning the leftmost longest match:

```
def m= java.util.regex.Pattern.compile( /(.*),(.*)/ ).matcher( 'one,two,three' )
m.matches()
assert m.group(1) == 'one,two' //what was matched between the first parens
assert m.group(2) == 'three' //what was matched between the second parens

assert m.hasGroup() //misc method to check whether the pattern has groups
assert m.groupCount() == 2 //misc method to count them
```

Anything between parentheses is a capturing group, whose matched values can be accessed later:

```
//we can access matched values in groups outside the pattern using
//longhand syntax...
def m= java.util.regex.Pattern.compile( /(a*)(b*)/ ).matcher( 'aaabb' )
m.matches()
assert m.group(1) == 'aaa' && m.start(1) == 0 && m.end(1) == 3
assert m.group(2) == 'bb' && m.start(2) == 3 && m.end(2) == 5
assert m.group(0) == 'aaabb' //group(0) is the entire string
assert m.group() == 'aaabb' && m.start() == 0 && m.end() == 5
//parameters default to 0

//...or outside the pattern using indexing (don't forget the first [0] index)...
m= java.util.regex.Pattern.compile( /(a*)(b*)/ ).matcher( 'aaabb' )
m.matches()
assert m[0][0] == 'aaabb' //the entire string
assert m[0][1] == 'aaa' && m.start(1) == 0 && m.end(1) == 3
assert m[0][2] == 'bb' && m.start(2) == 3 && m.end(2) == 5

//...or within the pattern using \n notation:
assert 'aaabb,aaa,bb' =~ /(a*)(b*),\1,\2/
// \1 is the first group matched, \2 the second matched

assert 'abbcc,abb,bb,cc' =~ /(a(b*))(\1),\1,\2,\3/
//groups numbered by sequence of their opening parens from left to right
assert 'abcddd,ab,ddd' =~ /(a(?:b))(?>c)(d*),\1,\2/
//groups beginning with ?: or ?> aren't numbered
assert 'aba,a,b' =~ /(a(b)?)+,\1,\2/
//second match for \1 has no match for \2, so \2 keeps value from first match

assert 'abc,bc' =~ /a(bc)?,\1/
assert !( 'a,' =~ /a(bc)?,\1/ )
```

```
//referencing \1 causes entire match to fail if it hasn't already matched
assert !( 'a' ==~ /[abc]\1/ )
//referencing a group within itself causes entire match to fail
```

\1 through \9 in patterns are always interpreted as group references, and a backslash-escaped number greater than 9 is treated as a group reference if at least that many groups exist at that point in the string pattern. Otherwise digits are dropped until either the number is smaller or equal to the existing number of groups or it is one digit. Grouping parentheses and group references cannot be used inside character classes.

Some miscellaneous methods:

```
def m= ( ~/ (a*)bc/ ).matcher( 'bc' ) //another longhand syntax
m.matches()
assert m.group(1) == null && m.start(1) == -1 && m.end(1) == -1
//if match successful but group didn't match anything

def p= java.util.regex.Pattern.compile( /ab*c/ )
assert p.pattern() == /ab*c/ //retrieve the definition from a compiled pattern
```

Finding Patterns in Strings

As well as matching an entire string to a pattern, we can also find a pattern within a string using =~ syntax:

```
assert 'abcdefg' =~ /cde/ //is 'cde' within 'abcdefg'?
assert ! ( 'abcdefg' =~ /ace/ )
assert java.util.regex.Pattern.compile( /cde/ ).matcher( 'abcdefg' ).find()
//alternative syntax

assert 'xxx z9g\t\nxxx' =~ /\s\w\d.\t\n/
//special characters work the same as with ==~ matching
assert ( 'xxg0oDbYexxx' =~ /(?!i)goodbye/ )
//flags also work the same as with ==~
assert 'xxxbatxxx' =~ /b[aeiou]t/
//character classes also work the same as with ==~
```

There can be more than one occurrence of the pattern:

```
def s= 'horse house'
assert s =~ /ho.se/ //to check for the first occurrence only
def m= ( s =~ /ho.se/ )
assert m.size() == 2 && m[0] == 'horse' && m[1] == 'house'
//to retrieve all occurrences

def l= []
s.eachMatch( /ho.se/ ){ l << it[0] } //alternative syntax, be sure to use it[0]
assert l == ['horse', 'house']
def l2= []
s.eachMatch( /abc/ ){ l2 << it[0] } //no matches
assert l2 == []
def l3= []
s.eachMatch( /hor./ ){ l3 << it[0] } //one match only
assert l3 == ['hors']
```

Some longhand syntax, with various methods:

```
import java.util.regex.Pattern
def s= 'hoose horse house'
def m= Pattern.compile(/ho.se/).matcher(s)
assert m.find() && s[m.start()..<m.end()] == 'hoose'
assert m.find() && s[m.start()..<m.end()] == 'horse'
assert m.find() && s[m.start()..<m.end()] == 'house'
assert ! m.find()
assert m.reset() && s[m.start()..<m.end()] == 'hoose'
//use reset() to find from beginning
```

```

assert m.find() && s[m.start()..<m.end()] == 'horse'
assert m.find(1) && s[m.start()..<m.end()] == 'horse'
//giving a parameter to find() starts finding from that index
m.setIndex(1)
//alternatively, calling setIndex() resets from that index, without finding
//until find() called

assert m.find() && s[m.start()..<m.end()] == 'horse'

```

We can group when finding with `=~` just as we do when matching with `==~`:

```

def m= ( 'mistlemuscle' =~ /m(.)s(.)le/ )
assert m.size() == 2
assert m.count == 2 //alternative to size()
assert m[0] == ['mistle', 'i', 't']
assert m[0].size() == 3 && m[0][0] == 'mistle' &&
m[0][1] == 'i' && m[0][2] == 't'
assert m[1] == ['muscle', 'u', 'c']
assert m[1].size() == 3 && m[1][0] == 'muscle' &&
m[1][1] == 'u' && m[1][2] == 'c'

//using the eachMatch() method...
def l= []
'mistlemuscle'.eachMatch( /m(.)s(.)le/ ){ l << it }
assert l*.toList() == [['mistle', 'i', 't'], ['muscle', 'u', 'c']]
def l2= []
'mistle'.eachMatch( /m(.)s(.)le/ ){ l2 << it }
assert l2*.toList() == [['mistle', 'i', 't']]
def l3= []
'practical'.eachMatch( /m(.)s(.)le/ ){ l3 << it }
assert l3*.toList() == []

//using longhand notation...
import java.util.regex.Pattern
m= Pattern.compile( /(a+)(b+)/ ).matcher( 'aaabbcccaabbb' )
m.find()
assert m.group(1) == 'aaa' && m.start(1) == 0 && m.end(1) == 3 &&
m.group(2) == 'bb' && m.start(2) == 3 && m.end(2) == 5 &&
m.group() == 'aaabb' && m.start() == 0 && m.end() == 5
m.find()
assert m.group(1) == 'aa' && m.start(1) == 8 && m.end(1) == 10 &&
m.group(2) == 'bbb' && m.start(2) == 10 && m.end(2) == 13 &&
m.group() == 'aabbb' && m.start() == 8 && m.end() == 13

```

Calling `collect()` and `each()` require some special tricks to work:

```

def m= ('redeem coffee' =~ /ee/)
assert m.collect{it} == ['ee', 'ee']
//when calling collect() on a pattern with no groups...
assert m.collect{it} == []
//...we must call reset() if we want to access the found matches again
m.reset()
assert m.collect{it} == ['ee', 'ee']

def l= [] //ditto for each()
m.each{ l << it }
assert l == []
m.reset()
l= []
m.each{ l << it }
assert l == ['ee', 'ee']

l= [] //ditto for eachWithIndex
m.eachWithIndex{it, i-> l << it+i }
assert l == []
m.reset()
l= []

```

```

m.eachWithIndex{it, i-> 1 << it+i }
assert l == ['ee0', 'ee1']

m= ('play the game\nfollow the rules' =~ /(?m)^(.*?) the (.*?)$/)
//for a pattern with groups...
l= []
m.each{g0, g1, g2-> 1 << [g0, g1, g2] }
//...we must pass the groups separately to the closure of each()
assert l == [['play the game', 'play', 'game'],
['follow the rules', 'follow', 'rules']]

m= ( 'mistlemuscle' =~ /m(.)s(.)le/ )
assert m[1] == ['muscle', 'u', 'c']
assert m.group(0) == 'muscle' && m.group(1) == 'u' && m.group(2) == 'c'
//only call group() after using subscripting first

```

Aggregate functions we can use are:

```

assert ('tone, true, tame, tape, take, tile, time' =~ /t..e/).
findAll{ it[1] == 'a' } == ['tame', 'tape', 'take']
assert ('tone, true, tame, tape, take, tile, time' =~ /t..e/).
find{ it[1] == 'a' } == 'tame'
assert ('tone, true, tame, tape, take, tile, time' =~ /t..e/).
findIndexof{ it[1] == 'a' } == 2 //index of 'tame'
assert ('tone, true, tame, tape, take, tile, time' =~ /t..e/).
any{ it[1] == 'a' }
assert ! ('tone, true, tame, tape, take, tile, time' =~ /t..e/).
every{ it[1] == 'a' }

```

The sequence of text joined by operators such as | ? * + {} has no effect on the success of the ==~ matcher, but does affect what's found with the =~ finder. The first choice of the | is found first, and backtracking to the second choice is only tried if necessary. The choice of the ? is tried first, and backtracking to ignore the choice only tried if necessary. As much as possible of the * + {} is found first, and backtracking to find less text only tried if necessary.

```

assert ('abcdefg' =~ /bcd|bcdef/)[0] == 'bcd'
assert ('abcdefg' =~ /bcdef|bcd/)[0] == 'bcdef'
//first choice always tried first

assert ('Friday 13th' =~ /Fri(day)?/)[0][0] == 'Friday'

assert ('Say "hello" and "goodbye" to the world!' =~ /".*"/)[0] ==
'hello" and "goodbye"
l= []
'Say "hello" and "goodbye" to the world!'.eachMatch( /"[^"]*" / ){ l << it }
//use NOT DOUBLE-QUOTES instead of ANY CHARACTER
assert l*.toList() == [['"hello"'], ["goodbye"]]

```

Because the ? and * operators can match nothing, they may not always be intuitive to understand:

```

def m= ('grgggr' =~ /g?/)
def l= []
for( int i in 0..<(m.size() as int) ) l << m[i]
assert l == ['g', '', 'g', 'g', 'g', '', '']
// ? also matches the empty space before each 'r', and the end of string

m= ('grgggr' =~ /g*/)
l= []
for( int i in 0..<(m.size() as int) ) l << m[i]
assert l == ['g', '', 'ggg', '', '']
// * also matches the empty space before each 'r', and the end of string

m= ('grgggr' =~ /g+/)
l= []
for( int i in 0..<(m.size() as int) ) l << m[i]
assert l == ['g', 'ggg'] // + repetition is the most intuitive to use

```

By putting a ? after the operators ? * + {}, we can make them "lazy" instead of "greedy", that is, as little as possible is found first, and backtracking to find MORE text is tried if necessary:

```
assert ('Friday 13th' =~ /Fri(day)??/)[0][0] == 'Fri' //instead of 'Friday'

def l= []
'Say "hello" and "goodbye" to the world!'.eachMatch( /\.*/ ){ l << it }
assert l*.toList() == [["hello"], ["goodbye"]]
```

We've seen some longhand methods such as 'find', 'matches', 'start', and 'end'. There's many more such methods:

```
def s= 'a quick quick dog'
def m= (s =~ /a.*k/)
//starts at the beginning, but doesn't try to match the entire string
assert m.lookingAt() && s[m.start()..<m.end()] == 'a quick quick'

//replaceFirst...
assert (s =~ /quick/).replaceFirst('fast') == 'a fast quick dog'
assert (s =~ /qu(ick)/).replaceFirst('kw$1') == 'a kwick quick dog'
//can reference groups in pattern using $
assert (s =~ /qu(ick)/).replaceFirst('kw\\$1') == 'a kw$1 quick dog'
//include literal $ by writing \$, escaping \ as \\

//utility method to create a literal replacement String for the given String...
import java.util.regex.Matcher
assert Matcher.quoteReplacement( 'kw$1' ) == 'kw\\$1'
assert (s =~ /qu(ick)/).replaceFirst( Matcher.quoteReplacement( 'kw$1' ) ) ==
'a kw$1 quick dog'

//we can mix GStrings and replacement group refs by mixing single-quoted and
//double-quoted strings...
def ice= 'ice cream'
assert ('some malting beer' =~ /a(lting ).*/).replaceFirst('e$1' + "$ice") ==
'some melting ice cream'

//replaceAll...
assert (s =~ /quick/).replaceAll('fast') == 'a fast fast dog'
s= 'a quickly quacking duck'
assert (s =~ /qu(.)ck/).replaceAll('kw$1ck') == 'a kwickly kwacking duck'

//another shorthand...
assert 'a quick quick dog'.replaceFirst(/qu(ick)/, 'kw\\$1') ==
'a kw$1 quick dog'
assert 'a quickly quacking duck'.replaceAll(/qu(.)ck/, 'kw$1ck') ==
'a kwickly kwacking duck'

//'appendReplacement' and 'appendTail' should be used together for more
//complex replacements...
m= 'one banana two havana three matana four' =~ /(.)ana/
def i=0, sb= new StringBuffer()
while( m.find() ) m.appendReplacement(sb, '$1a' + 'na'*i++)
m.appendTail(sb)
assert sb.toString() == 'one bana two havana three matanana four'
```

Similarly to back-references in patterns, \$1 through \$9 in replacement strings are always interpreted as group references, and a dollar-escaped number greater than 9 is treated as a group reference if at least that many groups exist in the string pattern. Otherwise digits are dropped until either the number is smaller or equal to the existing number of groups or it is one digit.

We've already seen the greedy and lazy operators. There's also possessive operators, which act like greedy operators, except they never backtrack. Whereas choosing greedy or lazy operators affects the efficiency of a match, they don't affect the outcome. However, possessive operators can affect the outcome of a match:

```
//the greedy * operator, with backwards backtracking...
def m= ( ~/(.*)((.*)/ ).matcher( 'one,two,three' )
```

```

assert m.matches() && m.group(1) == 'one,two' && m.group(2) == 'three'

//the lazy *? operator, with forwards backtracking...
m= ( ~/(.*?),(.*)/ ).matcher( 'one,two,three' )
assert m.matches() && m.group(1) == 'one' && m.group(2) == 'two,three'

//the possessive *+ operator, with no backtracking at all, even when doing so
//would cause a match...
assert ! ( ~/(.*+),(.*)/ ).matcher( 'one,two,three' ).matches()

//we can qualify other operators with possessiveness, such as ++, ?+, {m,n}+...
m= ( ~/([abc,]*+),(.*)/ ).matcher( 'abba,and,beegees' )
assert ! m.matches()
//greedily matches 'abba,a', but doesn't backtrack to 'abba'

```

Atomic grouping, a more general form of possessiveness, enables everything in the atom group to be considered as one token. No backtracking occurs within the group, only outside of it:

```

assert ! ( 'abbbc' ==~ /a(>b*)bc/ )
//after 'bbb' matched, no backtracking to 'bb' within atomic group

```

Atomic grouping and possessiveness are handy with nested repetition, allowing much faster match failures.

Finding Positions in Strings

We can use `^` and `$` to match the beginning and end of each line using flag `m`:

```

def s= 'an apple\nthe lime\na banana'
assert ! ( s =~ /^a.{7}$/ )
//normally, ^ matches the beginning of the entire input,
//and $ matches its end

def m= ( s =~ /(?)^a.{7}$/ )
//in multi-line mode, ^ matches the beginning of each line,
//and $ matches each line's end

assert m.size() == 2 && m[0] == 'an apple' && m[1] == 'a banana'
assert m.toString() ==
'java.util.regex.Matcher[pattern=(?)^a.{7}$ region=0,26 lastmatch=a banana]'
//some technical info

assert ((s+'\n') =~ /(?)^a.{7}$/) // $ ignores any \n at the end of the string

import java.util.regex.Pattern
m= Pattern.compile(/^a.{7}$/, Pattern.MULTILINE).matcher(s)
//alternative to (?)m in longhand syntax
assert m.find() && s[m.start()..<m.end()] == 'an apple'
assert m.find() && s[m.start()..<m.end()] == 'a banana'
assert ! m.find()

```

At the end of strings with `\n` at the end, `$` matches twice:

```

m= ( 'nine\nlives' =~ /$/ )
assert m.find() && m.start() == 10 && m.end() == 10
// $ matches at end of string once only
assert ! m.find()

m= ( 'nine\nlives\n' =~ /$/ )
assert m.find() && m.start() == 10 && m.end() == 10
// $ matches just before \n ...
assert m.find() && m.start() == 11 && m.end() == 11
//...and again, $ matches after the \n
assert ! m.find()

m= ( 'nine\nlives\n' =~ /(?)$/ )

```

```

assert m.find() && m.start() == 4 && m.end() == 4
//in multiline mode, $ matches at end of each line
assert m.find() && m.start() == 10 && m.end() == 10
assert m.find() && m.start() == 11 && m.end() == 11
// $ also always matches after the \n in multiline mode
assert ! m.find()

m= ( 'nine\nlives\n' =~ /^/ )
// ^ matches at beginning of string once only,
//even if there's an \n at the end
assert m.find() && m.start() == 0 && m.end() == 0
assert ! m.find()

m= ( 'nine\nlives\n' =~ /^(?m)^/ )
assert m.find() && m.start() == 0 && m.end() == 0
assert m.find() && m.start() == 5 && m.end() == 5
//in multiline mode, ^ matches at beginning of each line
assert ! m.find()
// ^ also never matches after the \n in multiline mode

```

We can use `\A` `\Z` and `\z` to match the beginning and end of input, even in multiline mode:

```

def s1= 'an apple\na banana'
assert (s1 =~ /\A.{8}\n.{8}\Z/)
// \A always matches the beginning of the entire input, and \Z its end
assert (s1 =~ /\A.{8}\n.{8}\z/) // \z also matches its end

assert (s1 =~ /^(?m)\A.{8}\n.{8}\Z/)
// ?m flag has no effect on meaning of \A \Z and \z

def s2= s1 + '\n'
assert (s2 =~ /^(?m)\A.{8}\n.{8}\Z/)
// \Z ignores an extra \n when matching the end of input...
assert ! (s2 =~ /^(?m)\A.{8}\n.{8}\z/) // ...but \z is fussy

```

We can match at word boundaries:

```

// \b matches either the preceding or following character, but not both, is
//a word (matched by \w)
(0x20..0x7F).each{|it1->
(0x20..0x7F).each{|it2->
def s= "${it1 as char}${it2 as char}"
if( s =~ /\.b./ ) assert (s[0] =~ /\w/) ^ (s[1] =~ /\w/)
// ^ means xor (exclusive or)
} }

// \B matches where \b doesn't
assert (0x0..0x7F).findAll{ (it as char) =~ /\b/ && (it as char) =~ /\B/ }.
size() == 0

```

We can look behind or ahead of a position, ie, find a position based on text that precedes follows it, but without matching that text itself. We can only use fixed-length strings when looking behind, ie, literal text, character classes, finite repetition (`{length}` and `?`), and alternation where each string in it is also of fixed length, because the length of the match must be able to be predetermined:

```

//use (?=) to find the position just in front of all 'qu'...
assert 'the queen quietly quacked'.replaceAll( /^(?=qu)/, 'we' ) ==
'the wequeen wequietly wequacked'

//use (?!) to find all 'c' not followed by 'a'...
assert 'clever cats can count mice'.replaceAll( /c(?!a)/, 'k' ) ==
'klever cats can kount mike'

//use (?<=) to find all words ending in '-gry'...
assert 'The angry, hungry boy gried out.'.
replaceAll( /\b\w+(?<=gry)\b/, 'naughty' ) ==
'The naughty, naughty boy gried out.'

```



```
//use (?<!) to find 3-letter words not ending with 'e'...
assert 'The spy saw seven spuds.'.replaceAll( /\b\w{3}(?!e)\b/, 'hid' ) ==
'The hid hid seven spuds.'

//lookaheads and lookbehinds can contain capturing groups...
assert 'the landlord dared band led not'.
replaceAll( /\b\w{4,}(?<=(\w{3})d)\b/, '$1' ) ==
'the lor are ban led not'
```

Matching positions in a string is useful for splitting the string, and for inserting text:

```
assert 'The leaky cauldron.'.split(/\b/).toList() ==
['', 'The', ' ', 'leaky', ' ', 'cauldron', '.']
//note that an empty string is prepended
assert 'Hi, my, bye.'.split( /\b(?:\w)/ ).toList() ==
['', 'Hi', ',', 'my', ',', 'bye.']
assert 'The leaky cauldron.'.replaceAll(/\b/, '*') ==
'*The* *leaky* *cauldron*.'
//note that text inserted at beginning but not at end
```

We can split a string in many ways:

```
def s= 'hi,my,spy,tie,bye,,'
assert s.split( /,/ ).toList() == ['hi', 'my', 'spy', 'tie', 'bye']
assert s.split( /,/, 1 ).toList() == ['hi,my,spy,tie,bye,,']
//extra argument gives max number of splits
assert s.split( /,/, 2 ).toList() == ['hi', 'my,spy,tie,bye,,']
assert s.split( /,/, 3 ).toList() == ['hi', 'my', 'spy,tie,bye,,']
assert s.split( /,/, 0 ).toList() == ['hi', 'my', 'spy', 'tie', 'bye']
//any number of splits; same as no arg
assert s.split( /,/, -1 ).toList() == ['hi', 'my', 'spy', 'tie', 'bye', '', '']
//a negative arg doesn't remove trailing empty strings

assert ( ~/,/ ).split(s).toList() == ['hi', 'my', 'spy', 'tie', 'bye']
//alternative syntax
assert ( ~/,/ ).split(s, 2).toList() == ['hi', 'my,spy,tie,bye,,']
```

Restricting a String to a Region for a Pattern

We can set the limit of the part of the input string that will be searched to find a match:

```
import java.util.regex.Pattern
def m= Pattern.compile( /abc+/ ).matcher( 'aaabc' )
assert m.find()
m.region(1, 4) //restrict string 'aaabc' to a region within, ie, 'aab'
assert ! m.find()
assert m.regionStart() == 1 && m.regionEnd() == 4
assert ! m.region(1, 4).find() //alternative syntax

//we can make a region's boundaries transparent to lookahead and boundary
//matching constructs...
m= Pattern.compile( /abc\b/ ).matcher( 'aaabcdef' )
m.region(1, 5)
assert m.find() //doesn't consider whether there's a word boundary (\b) after
//'abc' in full string
assert ! m.hasTransparentBounds()
m.region(1, 5)
m.useTransparentBounds(true)
assert ! m.find() //doesn't find anything because the \b doesn't match
assert m.hasTransparentBounds()
assert ! m.region(1, 5).useTransparentBounds(true).find() //alternative syntax

//we can decide whether to match anchors such as ^ and $ at the boundaries of
//the region...
m= Pattern.compile( /^abc$/ ).matcher( 'aaabcdef' )
```

```
m.region(2, 5)
assert m.find()
assert m.hasAnchoringBounds() //match such anchors by default
m.region(2, 5)
m.useAnchoringBounds(false)
assert ! m.find() //the ^ and $ no longer match
assert ! m.region(2, 5).useAnchoringBounds(false).find() //alternative syntax
```

JN2015-Files

This page last changed on Aug 30, 2007 by [gavingrover](#).

To see the OS-dependent characters used for formatting filenames (here, when running on Windows):

```
assert File.separator == '\\' && File.separatorChar == '\\' as char
//used for formatting file names
assert File.pathSeparator == ';' && File.pathSeparatorChar == ';' as char
```

Instances of File are immutable representations of objects in the file system, that may or may not exist. To see different formats of a filename (here, when running within D:\Groovy\Scripts directory):

```
def f= new File('File.txt') //relative file name
assert f.name == 'File.txt'
assert ! f.isAbsolute()
assert f.path == 'File.txt'
assert f.parent == null
assert f.absolutePath == 'D:\\Groovy\\Scripts\\File.txt' //returns a string
assert f.absoluteFile.toString() == 'D:\\Groovy\\Scripts\\File.txt'
//returns a File object instead of string
assert f.canonicalPath == 'D:\\Groovy\\Scripts\\File.txt'
assert f.canonicalFile.toString() == 'D:\\Groovy\\Scripts\\File.txt'
//returns a File object instead of string
assert f.toURI().toString() == 'file:/D:/Groovy/Scripts/File.txt'
//toURI() returns a URI object

f= new File('D:/Groovy/Scripts/File.txt') //absolute file name
assert f.name == 'File.txt'
assert f.isAbsolute()
assert f.path == 'D:\\Groovy\\Scripts\\File.txt'
assert f.parent == 'D:\\Groovy\\Scripts'
assert f.parentFile.toString() == 'D:\\Groovy\\Scripts'
//returns a File object instead of string
assert f.absolutePath == 'D:\\Groovy\\Scripts\\File.txt'
assert f.canonicalPath == 'D:\\Groovy\\Scripts\\File.txt'

f= new File('../File.txt')
assert f.name == 'File.txt'
assert ! f.isAbsolute()
assert f.path == '..\\File.txt'
assert f.parent == '..'
assert f.absolutePath == 'D:\\Groovy\\Scripts\\..\\File.txt'
assert f.canonicalPath == 'D:\\Groovy\\File.txt'

f= new File('') //current directory
assert f.name == ''
assert ! f.isAbsolute()
assert f.path == ''
assert f.parent == null
assert f.absolutePath == 'D:\\Groovy\\Scripts'
assert f.canonicalPath == 'D:\\Groovy\\Scripts'

assert new File('File.txt') == new File('File.txt')
//compares two filenames' lexical names
assert new File('File.txt').compareTo(new File('File.txt')) == 0
//equivalent method name
assert new File('File.txt') != new File('../Scripts/File.txt')
//lexical names different (although files are the same)
```

None of the above example's files were created. Files are only created by some event:

```
def f1= new File('File1.txt')
f1 << 'abcdefg'
//file created by writing to it; file appended to if it already exists
assert f1.length() == 7 && f1.size() == 7
assert f1.isFile() && ! f1.isDirectory() && ! f1.isHidden()
```

```

def f2= new File('D:/Groovy/Scripts', 'File2.txt')
//we can optionally supply the parent, either as a string...
f2= new File(new File('D:/Groovy/Scripts'), 'File2.txt')
//...or as a File object
assert ! f2.exists()
f2.createNewFile() //if it doesn't already exist
assert f2.exists()

def d1= new File('Directory1')
d1.mkdir() //make directory, if it doesn't already exist
def d2= new File('Directory2/SubDir1')
d2.mkdirs()
//make directory, including necessary but nonexistent parent directories

println f1.getFreeSpace()
//the number of unallocated bytes in the partition this abstract file is in
println f1.getUsableSpace()
//the number of bytes available to this virtual machine in the partition
//this abstract file is in
println f1.getTotalSpace() //the size of the partition this abstract file is in

//We can set file permissions:

assert f2.setWritable(true, false) && f2.canWrite()
//set writable permission for every user
assert f2.setWritable(true) && f2.canWrite()
//set writable permission on file for owner only
assert f2.setWritable(false, false) && ! f2.canWrite()
//unset writable permission for every user
assert f2.setWritable(false) && ! f2.canWrite()
//unset writable permission on file for owner only
f2.writable= true //property format for owner only
assert f2.canWrite()

assert f2.setReadOnly() && ! f2.canWrite()
assert f2.setExecutable(true, false) && f2.canExecute()
//set executable permission for every user
assert f2.setExecutable(true) && f2.canExecute()
//set executable permission on file for owner only
f2.executable= true //property format for owner only
assert f2.canExecute()
assert ! f2.setExecutable(false)
//returns false because command unsuccessful: can't make file
//nonexecutable on Windows, though can on other systems

assert f2.setReadable(true, false) && f2.canRead()
//set readable permission for every user
assert f2.setReadable(true) && f2.canRead()
//set readable permission on file for owner only
f2.readable= true //property format for owner only
assert f2.canRead()
assert ! f2.setReadable(false)
//can't make file nonreadable on Windows

//We can retrieve a list of files from a directory:

assert new File('D:/Groovy/Scripts').list().toList() ==
['Script.bat', 'File1.txt', 'File2.txt', 'Directory1', 'Directory2']
//list() returns an array of strings

assert new File('Directory2').list().toList() == ['SubDir1']
assert new File('').list() == null
//list() returns null if directory not explicitly specified

```

```

assert new File('D:/Groovy/Scripts').list(
[accept:{d, f-> f ==~ /.?*?1.* / }] as FilenameFilter
).toList() == ['File1.txt', 'Directory1']
//filter taking dir (File) and file (String) arguments, returns boolean

assert new File('D:/Groovy/Scripts').list(
{d, f-> f ==~ /.?*?1.* / } as FilenameFilter
).toList() == ['File1.txt', 'Directory1'] //shorter syntax

assert new File('D:/Groovy/Scripts').listFiles().toList().name ==
['Script.bat', 'File1.txt', 'File2.txt', 'Directory1', 'Directory2']
//listFiles() returns array of File objects

assert new File('Directory2').listFiles().toList().toString() ==
['Directory2\SubDir1']

assert new File('D:/Groovy/Scripts').listFiles(
{dir, file-> file ==~ /.?*?\txt / } as FilenameFilter
).toList().name == [ 'File1.txt', 'File2.txt' ]

assert new File('D:/Groovy/Scripts').listFiles(
[accept:{file-> file ==~ /.?*?\txt / }] as FileFilter
).toList().name == [ 'File1.txt', 'File2.txt' ]
//use a filter taking one argument only, returning boolean

//Renaming and deleting files:

f2.renameTo( new File('RenamedFile2.txt') )
assert f2.name == 'File2.txt' //because File object is immutable
assert new File('RenamedFile2.txt').exists()

[new File('RenamedFile2.txt'), new File('Directory1'), new File('Directory2')].
each{ it.delete() } //delete files
assert ! new File('RenamedFile2.txt').exists()
assert ! new File('Directory1').exists()
assert new File('Directory2').exists()
//because each sub-directory must be deleted separately

assert new File('Directory2/SubDir1').delete() //returns true if file deleted OK
assert new File('Directory2').delete()
assert ! new File('Directory2').exists()

new File('File1.txt').deleteOnExit()
assert new File('File1.txt').exists() //but will be deleted when VM exits

def mod= new File('File1.txt').lastModified()
assert new File('File1.txt').setLastModified(mod - 60000)
//60 seconds previously, returns true if successful
new File('File1.txt').lastModified= mod - 120000
//property syntax for setting only
assert new File('File1.txt').lastModified() == mod - 120000

```

To perform general file manipulation in a file system, we can retrieve all the topmost directories:

```

println File.listRoots().toList().toString()
//listRoots() returns an array of File objects

```

To create a temporary file, with given prefix (of at least 3 chars) and suffix:

```

File.createTempFile('Tem', '.txt')
//created in directory for temporary files
File.createTempFile('Tem', '.txt', new File('D:\\Groovy\\Scripts'))
//eg, created D:/Groovy/Scripts/Tem59217.txt

```

We can read and write to files in various ways, as in this example:

```

def f1= new File('File1.txt') << 'abcdefg:hijklmnop:qrstuvwxyz\n'
//create and write to the file
f1.leftShift('123:456:7890\n') //equivalent method name
new File('File2.txt').createNewFile()
[new File('Directory1'), new File('Directory2/SubDir1')].each{ it.mkdirs() }

def list= []
new File('D:\\Groovy\\Scripts').eachFile{ list<< it.name }
//eachFile() returns a list of File objects
assert list ==
['Script.bat', 'File1.txt', 'File2.txt', 'Directory1', 'Directory2']

list= []
new File('D:\\Groovy\\Scripts').eachFileMatch(~/.File.*?.txt/){ list<< it.name }
//a regular expression, or any caseable expression
assert list == ['File1.txt', 'File2.txt']

list= []
new File('D:\\Groovy\\Scripts').eachFileRecurse{ list<< it.name }
assert list == ['Script.bat', 'File1.txt', 'File2.txt',
'Directory1', 'Directory2', 'SubDir1']

list= []
new File('D:\\Groovy\\Scripts').eachDir{ list<< it.name }
assert list == ['Directory1', 'Directory2']

list= []
f1.eachLine{ list<< it }
assert list == [ 'abcdefg:hijklmnop:qrstuvwxyz', '123:456:7890' ]

list= f1.readlines()
assert list == [ 'abcdefg:hijklmnop:qrstuvwxyz', '123:456:7890' ]

list= []
f1.splitEachLine(':'){ list<< it } //splits each line into a list
assert list == [
['abcdefg', 'hijklmnop', 'qrstuvwxyz', 'wxyz'],
['123', '456', '7890'],
]

def f2= new File('File2.txt')
f2.write('abcdefg\n') //can only write strings
assert f2.getText() == 'abcdefg\n'
f2.append('hijklmnop,')
f2.append(42) //can append any object
assert f2.getText() == "'abcdefg
hijklmnop,42'"

f2.write('#####', 'unicode') //overwrites existing contents
assert f2.getText('unicode') == '#####'
f2.append('#####', 'unicode') //also appends unicode marker 0xFEFF
assert f2.getText('unicode') == '#####' + (0xFEFF as char) + '#####'

[ new File('File1.txt'),
new File('File2.txt'),
new File('Directory1'),
new File('Directory2/SubDir1'),
new File('Directory2'),
].each{ it.delete() } //delete files used by this example

```

JN2025-Streams

This page last changed on Aug 30, 2007 by [gavingrover](#).

We can create streams of data from files, network resources, memory locations, etc, both input and output. To initially demonstrate the use of streams, we'll use streams around a file, both byte and Character streams. The methods introduced in these example can be used for any stream.

InputStreams and OutputStreams are streams of bytes:

```
def fos= new FileOutputStream('TestFile.txt')

//These methods are available for all output streams, not just FileOutputStream:
[ 21, 34, 43, 79 ].each{ fos.write(it) }
//write out the lowest-order 8 bits of the supplied integer
fos.flush()
fos.write([69, 32, 22] as byte[])
fos.write([10, 11, 12, 13, 88, 89] as byte[], 3, 2)
//write 2 bytes from array starting at index 3
fos.close()
try{ fos.write(77); assert 0 }catch(e){ assert e instanceof IOException }
//no writing after file closed

//check the byte contents of the file with a File utility method:
assert new File('TestFile.txt').readBytes().toList() ==
[ 21, 34, 43, 79, 69, 32, 22, 13, 88 ]

def fis= new FileInputStream('TestFile.txt')

//These methods are available for all input streams, not just FileInputStream:
assert fis.available() == 9
//an estimate of bytes left for reading or skipping in the input stream
assert fis.read() == 21 //actually, the next byte is returned as an integer
fis.skip(2) //skip over, here, 2 bytes of data from the stream
assert fis.available() == 6
def ba2= new byte[3]
fis.read(ba2)
assert ba2.toList() == [79, 69, 32]
def ba3= new byte[6]
assert fis.read(ba3, 3, 2) == 2 //fill ba3 with 2 elements from index 3,
//return num of elements copied, here, 2
assert ba3.toList() == [0, 0, 0, 22, 13, 0]
assert fis.read(ba3) == 1 //return num of elements copied, here, 1
assert ba3.toList() == [88, 0, 0, 22, 13, 0]
assert fis.read(ba3) == -1 //return -1 if already at end-of-stream

//true if this input stream support the mark() and reset() methods...
if( fis.markSupported() ){
fis.reset()
//reset reading to beginning of stream if mark() hasn't ever been called
assert fis.read() == 21
fis.mark(0) //mark this position in the stream; argument has no meaning here
fis.read(new byte[4])
fis.reset() //reset reading to where the last mark() method was called
assert fis.read() == 34
}
fis.close()
try{ fis.read(); assert 0 }catch(e){ assert e instanceof IOException }

new File('TestFile.txt').delete() // delete the file used by this example
```

Readers and Writers are streams of Characters:

```
def fw= new FileWriter('TestFile.txt')
```

```

//These methods are available for all writers, not just for FileWriter:
[ 'a', 'b' ].each{ fw.write(it as char) } //write out the supplied character
[ 'cd', 'efg' ].each{ fw.write(it) } //write out the supplied string
fw.flush()
fw.write(['h', 'i', 'j'] as char[])
fw.write(['h', 'i', 'j', 'k', 'l', 'm'] as char[], 3, 2)
//write 2 chars from array starting at index 3
fw.write('klmnopq', 2, 4) //write 4 chars from string starting at index 2
fw.append('q' as char). //these Java 5.0 methods allow chaining
append('rstuv').
append('vwxyz', 2, 6)
//use subsequence from index 2 to index 6 of supplied string
fw.close()
try{ fw.write('z'); assert 0 }catch(e){ assert e instanceof IOException }
//no writing after file closed

assert new File('TestFile.txt').readLines() == [ 'abcdefghijklmnopqrstuvwxy' ]

def fr= new FileReader('TestFile.txt')

//These methods are available for all readers, not just for FileReader:
if(fr.ready()){
assert fr.read() == 'a'
fr.skip(2) //skip over, here, 2 chars
def ca2= new char[3]
fr.read(ca2)
assert ca2.toList().toString() == ['d', 'e', 'f']
def ca3= new char[6]

assert fr.read(ca3, 3, 2) == 2 //fill ca3 with 2 elements from index 3,
//return num of elements copied, here, 2
assert ca3.toList().toString() == ['\0', '\0', '\0', 'g', 'h', '\0']
//similar to InputStream method
fr.skip(20)
assert fr.read(ca3) == -1 //return -1 if already at end-of-stream

//true if this input stream support the mark() and reset() methods...
if( fr.markSupported() ){
fr.reset()
//reset reading to beginning of stream if mark() hasn't ever been called
assert fr.read() == 'a' as char
fr.mark(0) //mark this position in the stream; argument has no meaning here
fr.read(new char[4])
fr.reset() //reset reading to where the last mark() method was called
assert fr.read() == 'b' as char
}
fr.close()
try{ fr.read(); assert 0 }catch(e){ assert e instanceof IOException }
}

new File('TestFile.txt').delete() //delete the file used by this example

```

Closing Streams

When we write to an output stream or writer such as `FileWriter`, we should always `close()` it in some way:

```

//here, because we don't close() the FileWriter, if there's an IOException,
//some written data may be lost...
def fw= new FileWriter('TestFile1.txt')
try{
fw.write('abc\r\ndefg')
throw new IOException('') //simulate error on write() in previous line

```



```

}catch(e){ }
assert new File('TestFile1.txt').readLines().toList() == []
//nothing written because wasn't closed or flushed
new File('TestFile1.txt').delete()
assert new File('TestFile1.txt').exists() //not deleted because wasn't closed

//here, we close() the FileWriter in a 'finally' block, not losing any written
//data...
def fw2= new FileWriter('TestFile2.txt')
try{
try{
fw2.write('abc\r\ndefg')
throw new IOException('') //simulate error on write() in previous line
}finally{
fw2.close() //or flush() file so no data will be lost when exception thrown
}
}catch(e){ }
assert new File('TestFile2.txt').readLines() == ['abc', 'defg']
//contents written OK
new File('TestFile2.txt').delete()
assert ! new File('TestFile2.txt').exists() //file deleted OK

//using withWriter() always closes the File, whatever is thrown inside
//closure...
try{
new File('TestFile3.txt').withWriter(){ w->
w.write('abc\r\ndefg')
throw new IOException('') //simulate error on write() in previous line
}
}catch(e){ }
new File('TestFile3.txt').delete()
assert ! new File('TestFile3.txt').exists()
//deleted OK because withWriter() closed the file

```

We can choose from many such methods to read and write characters to streams, where the stream is always closed automatically. Here's some methods which use a Reader and/or Writer. Although these examples use Files, all these methods work for other streamed resources also.

```

new File('TestFile1.txt').withWriter{ w->
w<< 'abc' << 'def' //operator syntax
w.leftShift('ghi').leftShift('jkl') //equivalent method name
}

//file overwritten because it already exists...
new File('TestFile1.txt').withWriter('unicode'){ w->
w<< 'abcdefghij'
}

new File('TestFile1.txt').withWriterAppend('unicode'){ w->
w<< 'klmnop' //although appending, unicode marker 0xFEFF also added
}

//here, we'll use concatenation format for string because it's easier to read
def fw= new FileWriter('TestFile1.txt')
fw.withWriter{ w->
['ab,cd\n' + 'efg\n' + 'hi,jk\n' + 'l', 'mn,op'].each{
w<< it
}
}

new File('TestFile1.txt').withReader{ r->
assert r.read() == 'a'
}

def list= []
new File('TestFile1.txt').eachLine{

```

```

list<< it
}
assert list == ['ab,cd', 'efg', 'hi,jk', 'lmn,op']

assert new File('TestFile1.txt').readLines() ==
['ab,cd', 'efg', 'hi,jk', 'lmn,op']

assert new File('TestFile1.txt').text ==
'ab,cd\n' + 'efg\n' + 'hi,jk\n' + 'lmn,op' //property

//filter lines from file, and write to writer...
def fw2= new FileWriter('TestFile2.txt')
new File('TestFile1.txt').filterLine(fw2){ line->
! line.contains('g')
}
assert new File('TestFile2.txt').text ==
'ab,cd\r\n' + 'hi,jk\r\n' + 'lmn,op\r\n'
// \n was changed to \r\n for Windows

def fw2a= new FileWriter('TestFile2.txt')
new FileReader('TestFile1.txt').filterLine(fw2a){ line->
! line.contains('g')
}
assert new File('TestFile2.txt').text ==
'ab,cd\r\n' + 'hi,jk\r\n' + 'lmn,op\r\n'

def fr2= new FileReader('TestFile2.txt')
assert [fr2.readLine(), fr2.readLine()] == ['ab,cd', null]
//known bug: only returns correctly on first call
fr2.close()

new FileReader('TestFile2.txt').withReader{ r->
def ca= new char[25]
r.read(ca)
assert ca.toList().join('').trim() == 'ab,cd\r\n' + 'hi,jk\r\n' + 'lmn,op'
}

def list2= []
new FileReader('TestFile2.txt').splitEachLine(',') { line->
list2<< line
}
assert list2 == [ ['ab', 'cd'], ['hi', 'jk'], ['lmn', 'op'] ]

def fw2b= new FileWriter('TestFile2.txt')
new FileReader('TestFile1.txt').transformLine(fw2b){ line->
if( line.contains(',') ) line += ',z'
line
}
assert new File('TestFile2.txt').text ==
'ab,cd,z\r\n' + 'efg\r\n' + 'hi,jk,z\r\n' + 'lmn,op,z\r\n'
def fw2c= new FileWriter('TestFile2.txt')
new FileReader('TestFile1.txt').transformLine(fw2c){ line->
if( line.contains(',') ) line += ',z'
line
}
assert new File('TestFile2.txt').text ==
'ab,cd,z\r\n' + 'efg\r\n' + 'hi,jk,z\r\n' + 'lmn,op,z\r\n'

def fw2d= new FileWriter('TestFile2.txt')
new FileReader('TestFile1.txt').transformChar(fw2d){ ch->
if(ch == ',') ch= '***'
ch
}
assert new File('TestFile2.txt').text ==
'ab***cd\n' + 'efg\n' + 'hi***jk\n' + 'lmn***op' // \n not converted

```

```
[new File('TestFile1.txt'), new File('TestFile2.txt')].each{ it.delete() }
//delete files created by this example
```

Some methods which use an input and/or output stream which, although using Files in the examples, all work for other streamed resources also:

```
new File('TestFile1.txt').withOutputStream{ os->
os<< ([95, 96] as byte[]) //operator syntax for byte arrays
os.leftShift( [97, 98, 99] as byte[] ) //equivalent method name
}

assert new File('TestFile1.txt').readBytes().toList() == [95, 96, 97, 98, 99]

def list= []
new File('TestFile1.txt').eachByte(){ b->
list<< b
}
assert list == [95, 96, 97, 98, 99]

new FileOutputStream('TestFile1.txt').withStream{ os->
os.write([100, 101, 102, 103] as byte[])
}

def list2= []
new FileInputStream('TestFile1.txt').eachByte(){ b->
list2<< b
}
assert list2 == [100, 101, 102, 103]

new File('TestFile1.txt').withInputStream{ is->
def ba= new byte[5]
is.read(ba)
assert ba == [100, 101, 102, 103, 0]
}

new FileInputStream('TestFile1.txt').withStream{ s->
def ba= new byte[5]
s.read(ba)
assert ba == [100, 101, 102, 103, 0]
}

assert new FileInputStream('TestFile1.txt').text == 'defg'

assert new FileInputStream('TestFile1.txt').getText('unicode') == '###'

new FileInputStream('TestFile1.txt').withReader{ r->
assert r.read() == 'd'
}

new FileOutputStream('TestFile2.txt').withWriter('unicode'){ w->
w<< '#####'
}
assert new FileInputStream('TestFile2.txt').getText('unicode') == '#####'

new FileOutputStream('TestFile2.txt').withWriter{ w->
w<< new FileInputStream('TestFile1.txt')
//send contents of input stream directly to output stream
w<< 2.495 << '\n' //send an object to output stream as string, returning
//a writer, then send another object to that writer
w<< [3,4,5]
//send another object to output stream as string, returning a writer
}
assert new FileInputStream('TestFile2.txt').text == 'defg2.495\n' + '[3, 4, 5]'

def list3= []
```

```

new FileInputStream('TestFile2.txt').eachLine{ line->
list3<< line
}
assert list3 == ['defg2.495', '[3, 4, 5]']

new FileInputStream('TestFile2.txt').readLine() == 'defg2.495'

new FileInputStream('TestFile2.txt').readLines() == ['defg2.495', '[3, 4, 5]']

def fw3= new FileWriter('TestFile3.txt')
new FileInputStream('TestFile2.txt').filterLine(fw3){ line->
line.contains('g')
}
assert new File('TestFile3.txt').readLines() == ['defg2.495']

[ new File('TestFile1.txt'),
new File('TestFile2.txt'),
new File('TestFile3.txt')].each{ it.delete() }

```

Although the examples above are for files, they're all available for streams, readers, and writers around all other resources also.

Resource-specific Streams

When we met the `FileInputStream`, `FileOutputStream`, `FileReader`, and `FileWriter` in the above examples, we constructed them with a single `String`. We can also construct them with a file, and add an 'append' flag:

```

def fos= new FileOutputStream(new File('TestFile.txt'), true)
//appends to the file
fos= new FileOutputStream(new File('TestFile.txt'), false) //overwrites the file
fos= new FileOutputStream(new File('TestFile.txt')) //overwrites the file
fos= new FileOutputStream('TestFile.txt', true) //appends to the file
fos= new FileOutputStream('TestFile.txt', false) //overwrites the file
fos= new FileOutputStream('TestFile.txt') //overwrites the file

def fis= new FileInputStream(new File('TestFile.txt'))
fis= new FileInputStream('TestFile.txt')

def fw= new FileWriter(new File('TestFile.txt'), true) //appends to the file
fw= new FileWriter(new File('TestFile.txt'), true) //overwrites the file
fw= new FileWriter(new File('TestFile.txt')) //overwrites the file
fw= new FileWriter('TestFile.txt', true) //appends to the file
fw= new FileWriter('TestFile.txt', false) //overwrites the file
fw= new FileWriter('TestFile.txt') //overwrites the file

def fr= new FileReader(new File('TestFile.txt'))
fr= new FileReader('TestFile.txt')

```

There are many other streams, readers, and writers that wrap around specific resources. `ByteArrayInputStream` and `ByteArrayOutputStream` wrap around an array of bytes:

```

def bais= new ByteArrayInputStream( [33, 34, 35] as byte[] )
[33, 34, 35, -1].each{ assert bais.read() == it }
def bais2=
new ByteArrayInputStream( [33, 34, 35, 36, 37, 38, 39] as byte[], 2, 4 )
[35, 36, 37, 38, -1].each{ assert bais2.read() == it }

def baos= new ByteArrayOutputStream()
baos.write([100, 101, 102, 103] as byte[])
assert baos.size() == 4
assert baos.toByteArray().toList() == [100, 101, 102, 103]

def baos2= new ByteArrayOutputStream(10)
//we can specify initial size of internal buffer
baos.writeTo( baos2 ) //we can writeTo any OutputStream

```

```

assert baos2.toByteArray().toList() == [100, 101, 102, 103]
assert baos2.toString() == 'defg'
assert baos2.toString('unicode') == '###'
baos2.reset()
assert baos2.toByteArray().toList() == []

```

CharArrayReader and CharArrayWriter wrap around an array of chars:

```

def car= new CharArrayReader( ['a', 'b', 'c'] as char[] )
['a', 'b', 'c', -1].each{ assert car.read() == it }
def car2=
new CharArrayReader( ['a', 'b', 'c', 'd', 'e', 'f', 'g'] as char[], 2, 4 )
['c', 'd', 'e', 'f', -1].each{ assert car2.read() == it }

def caw= new CharArrayWriter()
caw.write(['a', 'b', 'c', 'd'] as char[])
assert caw.size() == 4
assert caw.toCharArray().toList() == ['a', 'b', 'c', 'd'].collect{ it as char }

def caw2= new CharArrayWriter(10)
//we can specify initial size of internal buffer
caw.writeTo( caw2 ) //we can writeTo any Writer
assert caw2.toCharArray().toList() == ['a', 'b', 'c', 'd'].collect{ it as char }
assert caw2.toString() == 'abcd'
caw2.reset()
assert caw2.toCharArray().toList() == []

```

StringReader and StringWriter wrap around a StringBuffer:

```

def sr= new StringReader( 'abcde' )
['a', 'b', 'c', 'd', 'e', -1].each{ assert sr.read() == it }

def sw= new StringWriter()
sw= new StringWriter(10) //we can specify initial size of StringBuffer
sw.write( 'abcde' )
assert sw.buffer.toString() == 'abcde'
assert sw.toString() == 'abcde'

```

InputStreamReader and OutputStreamWriter are a reader and writer pair that forms the bridge between byte streams and character streams. An InputStreamReader reads bytes from an InputStream and converts them to characters using a character-encoding, either the default or one specified by name. Similarly, an OutputStreamWriter converts characters to bytes using a character-encoding and then writes those bytes to an OutputStream. In this example, we use a FileInputStream and FileOutputStream, but any InputStream or OutputStream could be used:

```

def wtr= new OutputStreamWriter(new FileOutputStream('TheOutput.txt'))
wtr<< 'abc'
wtr.close()

def rdr= new InputStreamReader(new FileInputStream('TheOutput.txt'))
def list= []
rdr.eachLine{ list<< it }
assert list == ['abc']

println System.getProperty("file.encoding")
//to see the default file encoding used

wtr= new OutputStreamWriter(new FileOutputStream('TheOutput.txt'), 'unicode')
wtr<< 'def'
println wtr.encoding //perhaps, 'UTF-16', as 'unicode' above is an alias
wtr.close()

rdr= new InputStreamReader(new FileInputStream('TheOutput.txt'), 'unicode')
println rdr.encoding
list= []
rdr.eachLine{ list<< it }
assert list == ['def']

```

The buffered streams, reader, and writer wrap around another, buffering the data read or written so as to provide for the efficient processing of bytes, characters, arrays, and lines. It's very useful for streams, readers, and writers whose input/output operations are costly, such as files.

```
def bos= new BufferedOutputStream(new FileOutputStream('TheOutput.txt'))
println bos.buf.size() //see the size of the default buffer
bos= new BufferedOutputStream(new FileOutputStream('TheOutput.txt'), 16384)
//set the buffer size
assert bos.buf.size() == 16384
bos= new File('TheOutput.txt').newOutputStream()
//returns a buffered output stream

def bis= new BufferedInputStream(new FileInputStream('TheOutput.txt'))
bis= new BufferedInputStream(new FileInputStream('TheOutput.txt'), 16384)
//set the buffer size
bis= new File('TheOutput.txt').newInputStream()
//returns a buffered input stream

def bwtr= new BufferedWriter(new FileWriter('TheOutput.txt'))
bwtr= new BufferedWriter(new FileWriter('TheOutput.txt'), 16384)
//set the buffer size
bwtr= new File('TheOutput.txt').newWriter() //returns a buffered writer
bwtr= new File('TheOutput.txt').newWriter('unicode')
bwtr= new File('TheOutput.txt').newWriter(true) //appends to the file
bwtr= new File('TheOutput.txt').newWriter('unicode', true) //appends to the file

def brdr= new BufferedReader(new FileReader('TheOutput.txt'))
brdr= new BufferedReader(new FileReader('TheOutput.txt'), 16384)
//set the buffer size
brdr= new File('TheOutput.txt').newReader() //returns a buffered reader
brdr= new File('TheOutput.txt').newReader('unicode')
brdr= new FileInputStream('TheOutput.txt').newReader()

def file= new File('TheOutput.txt')
def wtr= file.newWriter()
wtr.writeLine('abc')
wtr.writeLine('def')
wtr.newLine() //writes blank line
wtr.close()
def rdr= file.newReader()
assert rdr.readLine() == 'abc' //doesn't return end-of-line characters
assert rdr.text == 'def' + '\r\n' + '\r\n' //returns end-of-line characters
```

A SequenceInputStream joins two other streams together:

```
def f1= new File('TheOutput1.txt'), f2= new File('TheOutput2.txt')
f1<< 'abcde'; f2<< 'fghij'
def is1= new FileInputStream(f1), is2= new FileInputStream(f2)
def sis= new SequenceInputStream(is1, is2)
assert sis.text == 'abcdefghij'
```

SequenceInputStream can also join three or more streams together using a Vector. See the upcoming tutorial on multi-threading for more on Vectors:

```
def f1= new File('TheOutput1.txt'),
f2= new File('TheOutput2.txt'),
f3= new File('TheOutput3.txt')
f1<< 'abc'; f2<< 'def'; f3<< 'ghij'
def list=[ new FileInputStream(f1),
new FileInputStream(f2),
new FileInputStream(f3) ]
def sis= new SequenceInputStream(new Vector(list).elements())
assert sis.text == 'abcdefghij'
```

A line-number reader keeps track of line numbers:

```
def w= new File('TheOutput.txt').newWriter()
```

```
w.writeLine('abc'); w.writeLine('defg'); w.close()

def lnr= new LineNumberReader(new FileReader('TheOutput.txt'))
lnr= new LineNumberReader(new FileReader('TheOutput.txt'), 16384)
//set the buffer size
assert lnr.lineNumber == 0
assert lnr.readLine() == 'abc'
assert lnr.lineNumber == 1
lnr.lineNumber= 4
assert lnr.readLine() == 'defg'
assert lnr.lineNumber == 5
```

A pushback input stream allows read input to be pushed back on:

```
def ba= [7, 8, 9, 10, 11, 12, 13] as byte[]
def pis= new PushbackInputStream(new ByteArrayInputStream(ba))
pis= new PushbackInputStream(new ByteArrayInputStream(ba), 1024)
//or specify buffer size
def ba2= new byte[3]
pis.read(ba2)
assert ba2.toList() == [7, 8, 9]

pis.unread(2)
pis.read(ba2)
assert ba2.toList() == [2, 10, 11]

pis.unread([3, 4, 5, 6] as byte[])
pis.read(ba2)
assert ba2.toList() == [3, 4, 5]
pis.read(ba2)
assert ba2.toList() == [6, 12, 13]
```

A pushback reader provides a similar facility for characters:

```
def ca= ['g', 'h', 'i', 'j', 'k', 'l', 'm'] as char[]
def prdr= new PushbackReader(new CharArrayReader(ca))
prdr= new PushbackReader(new CharArrayReader(ca), 1024)
//or specify buffer size
def ca2= new char[3]
prdr.read(ca2)
assert ca2.toList() == ['g', 'h', 'i'].collect{it as char}

prdr.unread('b' as int)
prdr.read(ca2)
assert ca2.toList() == ['b', 'j', 'k'].collect{it as char}

prdr.unread(['c', 'd', 'e', 'f'] as char[])
prdr.read(ca2)
assert ca2.toList() == ['c', 'd', 'e'].collect{it as char}
prdr.read(ca2)
assert ca2.toList() == ['f', 'l', 'm'].collect{it as char}

prdr.unread(['a', 'b', 'c', 'd', 'e', 'f', 'g'] as char[], 1, 4)
//offset 1, length 4 of array
prdr.read(ca2)
assert ca2.toList() == ['b', 'c', 'd'].collect{it as char}
```

A `DataOutputStream` writes out Groovy structures as bytes, and a `DataInputStream` reads such bytes in as Groovy structures:

```
def baos= new ByteArrayOutputStream(30)
def dos= new DataOutputStream(baos)
assert dos.size() == 0

def bais= new ByteArrayInputStream( baos.buf )
def dis= new DataInputStream(bais)
```

```

dos.writeBoolean( true )
assert baos.toByteArray().toList() == [1] //writes boolean as a 1-byte value
assert dis.readBoolean() == true

dos.writeByte( 200 ) //converted to -56, a 1-byte value
assert baos.toByteArray().toList() == [1, -56]
//'true', followed by '200 as byte'
assert dis.readByte() == -56
dis.reset() //resets input stream
dis.skipBytes(1) //we can skip bytes
assert dis.readUnsignedByte() == 200
baos.reset() //flushes backing stream
dis.reset()

dos.writeBytes('abcdefg') //writes string as a sequence of bytes
assert baos.toByteArray() as List == [97, 98, 99, 100, 101, 102, 103]
dis.reset()
def ba= new byte[5]
dis.readFully(ba) //readFully() is converse of writeBytes()
assert ba as List == [97, 98, 99, 100, 101]
dis.reset()

ba= new byte[5]
dis.readFully(ba, 1, 2) //offset 1 and length 2 of ba
assert ba as List == [0, 97, 98, 0, 0]
baos.reset(); dis.reset()

dos.writeChar('a' as int) //writes char as 2-byte value, high byte first
assert baos.toByteArray() as List == [0, 97]
assert dis.readChar() == 'a'
baos.reset(); dis.reset()

dos.writeChars('ab') //writes string as a sequence of characters
assert baos.toByteArray() as List == [0, 97, 0, 98]
baos.reset(); dis.reset() //DataInputStream has no readChars() method

dos.writeShort(5000) //writes a short as two bytes, high byte first
assert baos.toByteArray() as List == [19, -120] && 20*256 - 120 == 5000
assert dis.readShort() == 5000
dis.reset()
dis.readUnsignedShort() == 5000 //similar to readUnsignedByte()
baos.reset(); dis.reset()

dos.writeInt(5000) //writes an integer as four bytes, high byte first
assert baos.toByteArray() as List == [0, 0, 19, -120]
assert dis.readInt() == 5000
baos.reset(); dis.reset()

dos.writeLong(5000) //writes a long as eight bytes, high byte first
assert baos.toByteArray() as List == [0, 0, 0, 0, 0, 0, 19, -120]
assert dis.readLong() == 5000
baos.reset(); dis.reset()

dos.writeDouble(123.456)
//calls Double.doubleToLongBits(), writes as 8 bytes, high first
println baos.toByteArray() as List
assert dis.readDouble() == 123.456d
baos.reset(); dis.reset()

dos.writeFloat(123.456f)
//calls Float.floatToIntBits(), writes as 4 bytes, high first
println baos.toByteArray() as List
assert dis.readFloat() == 123.456f
baos.reset(); dis.reset()

dos.writeUTF('abc')

```



```
//writes using "modified UTF-8 encoding in a machine-independent manner"
assert baos.toByteArray() as List == [0, 3, 97, 98, 99]
//UTF-8 adds 0, 3 at beginning
assert dis.readUTF() == 'abc'
dis.reset()
assert DataInputStream.readUTF(dis) == 'abc'
//a static method to perform the same action
```

We'll meet more different types of streams, readers, and writers in the tutorials on Inheritance, Networking, Multi-threading, and others coming up.

This page last changed on Aug 30, 2007 by [gavingrover](#).

Blocks

We can embed a sequence of statements inside "try", called a "block". Defined variables are only visible within that block, not outside:

```
def a = 'good morning'
try{
def b = 'greetings', c = 'nice day'
//'def' keyword applies to both 'b' and 'c'

assert a == 'good morning'
assert b == 'greetings'
}
assert a == 'good morning'
//println b //a compile error if uncommented: b not visible here
```

Using the "def" keyword is optional because we are inside a script:

```
def c = 5
assert c == 5
d = 6
assert d == 6 //def keyword optional because we're within a script context
assert binding.variables.c == null
assert binding.variables.d == 6
//when def not used, variable becomes part of binding.variables
```

But variables without "def" are visible outside the block:

```
try{
h = 9
assert binding.variables.h == 9
}
assert h == 9
assert binding.variables.h == 9
```

We can't define a variable (using "def") with the same name as another already visible (ie, another "in scope"):

```
def a = 'island'
//def a = 'snake' //a compile error if uncommented: a already defined
try{
//def a = 'jewel' //a compile error if uncommented: a already defined
}
```

We can nest blocks:

```
def a = 123
try{
try{
try{
assert a == 123
}
}
}
```

Closures

We can take a sequence of statements that refers to its external context and assign it to a variable, then execute it later. It's technically called a "closable block", commonly called a "closure":

```

def a = 'coffee'
def c = {
  def b = 'tea'
  a + ' and ' + b //a refers to the variable a outside the closure,
  //and is remembered by the closure
}
assert c() == 'coffee and tea' //short for c.call()

```

The closure assigned to the variable (here, c) will remember its context (here, including a) even if that context is not in scope when the closure is called:

```

def c
try{
  def a = 'sugar'
  c = { a } //a closure always returns its only value
}
assert c() == 'sugar'
def d = c //we can also assign the closure to another variable
assert d() == 'sugar'

```

A closure always returns a value, the result of its last statement:

```

giveSeven = { 7 }
assert giveSeven() == 7 //value of last statement is returned

giveNull = { def a }
assert giveNull() == null //null returned if last statement has no value

```

By putting a closure within another, we can create two instances of it:

```

c = { def e = { 'milk' }; e }
d = c
assert c == d
v1 = c()
v2 = c()
assert v1 != v2

```

Closure Parameters

We can put parameters at the beginning of a closure definition, and pass values in when we call the closure:

```

def toTriple = {n -> n * 3}
assert toTriple.call( 5 ) == 15

```

We can also pass information out using the parameters:

```

def f = { list, value -> list << value }
x = []
f(x, 1)
f(x, 2,) //trailing comma in argument list OK
f(x, 3)
assert x == [1, 2, 3]

```

One parameter is always available, called "it", if no explicit parameters are named:

```

c = { it*3 }
assert c( 'run' ) == 'runrunrun'

```

If parameters aren't specified, "it" will still be implicitly defined, but be null:

```

//c = { def it = 789 }
//a compile error when uncommented: 'it' already implicitly defined
c = { value1 -> def it = 789; [value1, it] }
//works OK because no 'it' among parameters
assert c( 456 ) == [456, 789]
c = {-> def it = 789; it } //zero parameters, not even 'it', so works OK

```

```
assert c() == 789
```

Parameters can't have the same name as another variable in scope, except for the implicit parameter 'it':

```
def name= 'cup'
//def c={ name-> println (name) } //a compile error when uncommented:
//current scope already contains name 'name'
c= { def d= { 2 * it }; 3 * d(it) }
//'it' refers to immediately-surrounding closure's parameter in each case
assert c(5) == 30
```

If there's already a variable called 'it' in scope, we can access it using owner.it:

```
it= 2
c= { assert it == 3; assert owner.it == 2 }
c(3)
```

We can pass one closure into another as a parameter:

```
toTriple = {n -> n * 3}
runTwice = { a, c -> c( c(a) )}
assert runTwice( 5, toTriple ) == 45
```

We can return a closure from another:

```
def times= { x -> { y -> x * y }}
assert times(3)(4) == 12
```

There's a shortcut syntax when explicitly defining a closure within another closure call, where that closure is the last or only parameter:

```
def runTwice = { a, c -> c(c(a)) }
assert runTwice( 5, {it * 3} ) == 45 //usual syntax
assert runTwice( 5 ){it * 3} == 45
//when closure is last param, can put it after the param list

def runTwiceAndConcat = { c -> c() + c() }
assert runTwiceAndConcat( { 'plate' } ) == 'plateplate' //usual syntax
assert runTwiceAndConcat(){ 'bowl' } == 'bowlbowl' //shortcut form
assert runTwiceAndConcat{ 'mug' } == 'mugmug'
//can skip parens altogether if closure is only param

def runTwoClosures = { a, c1, c2 -> c1(c2(a)) }
//when more than one closure as last params
assert runTwoClosures( 5, {it*3}, {it*4} ) == 60 //usual syntax
assert runTwoClosures( 5 ){it*3}{it*4} == 60 //shortcut form
```

Arguments in a closure call can be named. They are interpreted as the keys in a map passed in as the first parameter:

```
def f= {m, i, j-> i + j + m.x + m.y }
assert f(6, x:4, y:3, 7) == 20

def g= {m, i, j, k, c-> c(i + j + k, m.x + m.y) }
assert g(y:5, 1, 2, x:6, 3){a,b-> a * b } == 66
```

We can enquire the number of parameters for a closure, both from inside and outside the closure:

```
c= {x,y,z-> getMaximumNumberOfParameters() }
assert c.getMaximumNumberOfParameters() == 3
assert c(4,5,6) == 3
```

A closure may have its last parameter/s assigned default value/s:

```
def e = { a, b, c=3, d='a' -> "${a+b+c}$d" }
assert e( 7, 4 ) == '14a'
assert e( 9, 8, 7 ) == '24a' //override default value of 'c'
```

A closure can take a varying number of arguments by prefixing its last parameter with `Object[]`, and accessing them using `'each'`:

```
def c = { arg, Object[] extras ->
def list= []
list<< arg
extras.each{ list<< it }
list
}
assert c( 1 )           == [ 1 ]
assert c( 1, 2 )       == [ 1, 2 ]
assert c( 1, 2, 3 )    == [ 1, 2, 3 ]
assert c( 1, 2, 3, 4 ) == [ 1, 2, 3, 4 ]
```

We can also prefix the last parameter of a closure with `Closure[]` to pass in a varying number of other closures, even using the shortcut syntax:

```
def apply = { a, Closure[] cc ->
(cc as List).inject(a){ flo, it-> it(flo) }
//apply the closures nestedly to the initial value
}
assert apply(7){it*3}{it+1}{it*2}.toString() == '44'
```

When we call a closure with a list argument, if there's no closure defined with a list parameter, the arguments are passed in as separate parameters:

```
def c= {a, b, c-> a + b + c}
def list=[1,2,3]
assert c(list) == 6
```

A closure may be copied with its first parameter/s fixed to a constant value/s, using `curry`:

```
def concat = { p1, p2, p3 -> "$p1 $p2 $p3" }
def concatAfterFly = concat.curry( 'fly' )
assert concatAfterFly( 'drive', 'cycle' ) == 'fly drive cycle'
def concatAfterFlySwim = concatAfterFly.curry( 'swim' )
assert concatAfterFlySwim( 'walk' ) == 'fly swim walk'
```

In closures, we can use currying and parameter-count-varying together:

```
def c = { arg, Object[] extras -> arg + ', ' + extras.join(', ') }
def d = c.curry( 1 ) //curry first param only
assert d( 2, 3, 4 ) == '1, 2, 3, 4'
def e = c.curry( 1, 3 ) //curry part of Object[] also
assert e( 5 ) == '1, 3, 5'
def f = e.curry( 5, 7, 9, 11 ) //currying continues on Object
assert f( 13, 15 ) == '1, 3, 5, 7, 9, 11, 13, 15'
```

We can make closures recursive:

```
def gcd //predefine closure name
gcd={ m,n-> m%n==0? n: gcd(n,m%n) }
assert gcd( 28, 35 ) == 7
```

Functions

A function is similar to a closure, though a function can't access defined variables in its surrounding context:

```
a = 32 //def keyword not used for this one
def c = 'there', d = 'yonder'
def f(){
assert a == 32 //outer 'a' visible because 'def' keyword wasn't used with it
def c = 'here'
//compiles OK because other defined c invisible inside function definition
//println d //a compile error when uncommented: d not accessible
```

```

c
}
assert f() == 'here' //syntax to invoke a function

```

The def keyword is compulsory when defining functions:

```

def f(){
a = 1
c = { 'here, again' }
c()
}
assert f() == 'here, again'
//g(){ println 'there, again' }
//a compile error when uncommented: def keyword required

```

We use a special syntax to assign a function to another variable when using the original definition name:

```

def f(){ 77 } //define function using name 'f'
assert f() == 77
def g = this.&f //special syntax to assign function to another variable
assert g() == 77
def h = g //don't use special syntax here
assert h() == 77
f = 'something else' //this 'f' is a VARIABLE, not the function NAME
assert f() == 77 //the function name can't be reassigned

```

Unlike blocks and closures, we can't nest functions:

```

def f(){
//def g1(){ println 'there' }
//a compile error when uncommented: can't nest functions
'here'
}
assert f() == 'here'
try{
//def g2(){ println 'yonder' }
//a compile error when uncommented: can't nest functions
}
c = {
//def g3(){ println 'outer space' }
//a compile error when uncommented: can't nest functions
}
def h(){
try{ def c = { 'here, again' } }
//we can have blocks and closures within functions
}

```

Function Parameters

A function can have parameters, with which we can pass information both in and out:

```

def foo( list, value ){
list << value
}
x = []
foo(x, 1)
foo(x, 2)
assert x == [1, 2]

```

We can have more than one function of the same name if they each have different numbers of (untyped) parameters.

```

def foo(value){ 'v1' }
def foo(list, value){ 'v2' }
assert foo(9) == 'v1'
assert foo([], 1) == 'v2'

```

A function returns a value, unless prefixed by void instead of def, when it always returns null:

```
def f1(){ 7 }
assert f1() == 7 //value of last statement is returned

def f2(){ return 8; 3 }
assert f2() == 8 //return explicitly using return

void f3(){ 10 }
assert f3() == null //null always returned

//void f4(){ return 9 }
//a compile error when uncommented: can't use 'return' in a void function
```

When there's a method and closure with the same name and parameters, the method is chosen instead of the closure:

```
def c(){'method c'}
def c= {-> 'closure c'}
assert c() == 'method c'

def d(i){'method d'}
def d= {'closure d'}
assert d(9) == 'method d'
```

Some Similarities with Closures

We can use the shortcut invocation syntax for closure parameters:

```
def f(Closure c){ c() }
assert f{ 'heehee' } == 'heehee'
```

A function may have its last parameter/s assigned default value/s:

```
def dd( a, b=2 ){ "$a, $b" }
assert dd( 7, 4 ) == '7, 4'
assert dd( 9 ) == '9, 2'
```

Arguments in a function call can be named, interpreted as keys in a map passed in as first parameter:

```
def f(m, i, j){ i + j + m.x + m.y }
assert f(6, x:4, y:3, 7) == 20

def g(m, i, j, k, c){ c(i + j + k, m.x + m.y) }
assert g(y:5, 1, 2, x:6, 3){a,b-> a * b } == 66
```

A function can take a varying number of arguments by prefixing its last argument by Object[], and accessing them using each:

```
def c( arg, Object[] extras ){
  def list= []
  list<< arg
  extras.each{ list<< it }
  list
}
assert c( 1 ) == [ 1 ]
assert c( 1, 2, 3, 4 ) == [ 1, 2, 3, 4 ]
```

When we call a function with a list argument, if there's none defined with a list parameter, the arguments are passed in separately:

```
def x(a, b, c){a + b + c}
def list=[1,2,3]
assert x(list) == 6
```

We can call a function recursively by referencing its own name:

```
def gcd( m, n ){ if( m%n == 0 )return n; gcd(n,m%n) }  
assert gcd( 28, 35 ) == 7
```

This page last changed on Aug 30, 2007 by [gavingrover](#).

Accessing Private Variables

Closures and functions can't remember any information defined within themselves between invocations. If we want a closure to remember a variable between invocations, one only it has access to, we can nest the definitions inside a block:

```
def c
try{
def a= new Random() //only closure c can see this variable; it is private to c
c= { a.nextInt(100) }
}
100.times{ println c() }
try{ a; assert 0 }catch(e) //'a' inaccessible here
{ assert e instanceof MissingPropertyException }
```

We can have more than one closure accessing this private variable:

```
def counterInit, counterIncr, counterDecr, counterShow
//common beginning of names to show common private variable/s
try{
def count
counterInit= { count= it }
counterIncr= { count++ }
counterDecr= { count-- }
counterShow= { count }
}
counterInit(0)
counterIncr(); counterIncr(); counterDecr(); counterIncr()
assert counterShow() == 2
```

We can also put all closures accessing common private variables in a map to show they're related:

```
def counter= [:]
try{
def count= 0
counter.incr= { count++; counter.show() }
counter.decr= { count--; counter.show() }
counter.show= { count }
}

counter.incr()
assert counter.show() == 1
```

Expando

We can access private variables with an Expando instead. An expando allows us to assign closures to Expando names:

```
def counter= new Expando()
try{
def count= 0
counter.incr= { count++; show() }
//no need to qualify closure call with expando name
counter.decr= { count--; show() }
counter.show= { timesShown++; count }
counter.timesShown= 0
//we can associate any value, not just closures, to expando keys
}
counter.incr(); counter.incr(); counter.decr(); counter.incr()
assert counter.show() == 2
```

An expando can also be used when common private variables aren't used:

```

def language= new Expando()
language.name= "Groovy"
language.numLetters= { name.size() }

assert language.numLetters() == 6
language.name= "Ruby"
assert language.numLetters() == 4
language.name= "PHP"
assert language.numLetters() == 3

```

Like individual closures, closures in expandos see all external variables all the way to the outermost block. This is not always helpful for large programs as it can limit our choice of names:

```

def a= 7
try{
//... .. lots of lines and blocks in between ... ..
def exp= new Expando()
exp.c= {
//def a= 2 //does not compile if uncommented: a is already defined
//... ..
}
}

```

For single-argument closures, both standalone and within expandos, we can use the implicit parameter as a map for all variables to ensure they're all valid, though the syntax is not very elegant:

```

def a= 7
try{
def c= {
it= [it: it]
it.a= 2
it.it + it.a
}
assert c(3) == 5
}

```

There is a better way to ensure a chosen variable name will not "shadow" another from the same scope.

Static Classes

Just as we can use functions instead of closures to hide names from the surrounding context, so also we can use static classes instead of expandos to hide such external names. We use the static keyword to qualify the individual definitions in a class definition:

```

def a= 7
def a= 7
class Counter{
//variable within a class is called a field...
static public count= 0
//count has 'public' keyword, meaning it's visible from outside class

//function within a class is called a method...
static incr(){
count++
//variables defined within class visible from everywhere else inside class
}
static decr(){
//println a //compile error if uncommented:
//a is outside the class and not visible
count--
}
}
Counter.incr(); Counter.incr(); Counter.decr(); 5.times{ Counter.incr() }
assert Counter.count == 6

```

Methods act quite similar to standalone functions. They can take parameters:

```

class Counter{
static private count = 0
//qualified with private, meaning not visible from outside class
static incr( n ){ count += n }
static decr( count ){ this.count -= count }
//params can have same name as a field; 'this.' prefix accesses field
static show(){ count }
}
Counter.incr(2); Counter.incr(7); Counter.decr(4); Counter.incr(6)
assert Counter.show() == 11

```

We can have more than one method of the same name if they each have different numbers of parameters.

```

class Counter{
static private count = 0
static incr(){ count++ }
static incr( n ){ count += n }
static decr(){ count-- }
static decr( n ){ count -= n }
static show(){ count }
}
Counter.incr(17); Counter.incr(); Counter.decr(4)
assert Counter.show() == 14

```

Methods are also similar to other aspects of functions:

```

class U{
static a(x, Closure c){ c(x) }
static b( a, b=2 ){ "$a, $b" } //last argument/s assigned default values
static c( arg, Object[] extras ){ arg + extras.inject(0){ flo, it-> flo+it } }
static gcd( m, n ){ if( m%n == 0 )return n; gcd(n,m%n) }
//recursion by calling own name
}
assert U.a(7){ it*it } == 49 //shorthand passing of closures as parameters
assert U.b(7, 4) == '7, 4'
assert U.b(9) == '9, 2'
assert U.c(1,2,3,4,5) == 15 //varying number of arguments using Object[]
assert U.gcd( 28, 35 ) == 7

```

We can assign each method of a static class to a variable and access it directly similar to how we can with functions:

```

class U{
static private a= 11
static f(n){ a*n }
}
assert U.f(4) == 44
def g= U.&f //special syntax to assign method to variable
assert g(4) == 44
def h = g //don't use special syntax here
assert h(4) == 44

```

When there's no accessibility keyword like 'public' or 'private' in front of a field within a static class, it becomes a property, meaning two extra methods are created:

```

class Counter{
static count = 0
//property because no accessibility keyword (eg 'public', 'private')
static incr( n ){ count += n }
static decr( n ){ count -= n }
}
Counter.incr(7); Counter.decr(4)
assert Counter.count == 3
assert Counter.getCount() == 3 //extra method for property, called a 'getter'
Counter.setCount(34) //extra method for property, called a 'setter'
assert Counter.getCount() == 34

```

When we access the property value using normal syntax, the 'getter' or 'setter' is also called:

```
class Counter{
static count= 0 //'count' is a property

//we can define our own logic for the getter and/or setter...
static setCount(n){ count= n*2 } //set the value to twice what's supplied
static getCount(){ 'count: '+ count }
//return the value as a String with 'count: ' prepended
}
Counter.setCount(23) //our own 'setCount' method is called here
assert Counter.getCount() == 'count: 46'
//our own 'getCount' method is called here
assert Counter.count == 'count: 46'
//our own 'getCount' method is also called here
Counter.count= 7
assert Counter.count == 'count: 14'
//our own 'setCount' method was also called in previous line
```

To run some code, called a static initializer, the first time the static class is accessed. We can have more than one static initializer in a class.

```
class Counter{
static count = 0
static{ println 'Counter first accessed' } //static initializer
static incr( n ){ count += n }
static decr( n ){ count -= n }
}
println 'incrementing...'
Counter.incr(7) //'Counter first accessed' printed here
println 'decrementing...'
Counter.decr(4) //nothing printed
```

Instantiable Classes

We can write instantiable classes, templates from which we can construct many instances, called objects or class instances. We don't use the static keyword before the definitions within the class:

```
class Counter{
def count = 0 //must use def inside classes if no other keyword before name
def incr( n ){ count += n }
def decr( n ){ count -= n }
}
def c1= new Counter() //create a new object from class
c1.incr(2); c1.incr(7); c1.decr(4); c1.incr(6)
assert c1.count == 11

def c2= new Counter() //create another new object from class
c2.incr(5); c2.decr(2)
assert c2.count == 3
```

We can run some code the first time each object instance is constructed. First, the instance initializer/s are run. Next run is the constructor with the same number of arguments as in the calling code.

```
class Counter{
def count
{ println 'Counter created' }
//instance initializer shown by using standalone curlyes
Counter(){ count= 0 }
//instance constructor shown by using class name
Counter(n){ count= n }
//another constructor with a different number of arguments
def incr( n ){ count += n }
def decr( n ){ count -= n }
}
c = new Counter() //'Counter created' printed
```

```

c.incr(17); c.decr(2)
assert c.count == 15
d = new Counter(2) //'Counter created' printed again
d.incr(12); d.decr(10); d.incr(3)
assert d.count == 7

```

If we don't define any constructors, we can pass values directly to fields within a class by adding them to the constructor call:

```

class Dog{
def sit
def number
def train(){ ([sit()] * number).join(' ') }
}
def d= new Dog( number:3, sit: {'Down boy!' } )
assert d.train() == 'Down boy! Down boy! Down boy!'

```

Methods, properties, and fields on instantiable classes act similarly to those on static classes:

```

class U{
private timesCalled= 0 //qualified with visibility, therefore a field
def count = 0 //a property
def a(x){ x }
def a(x, Closure c){ c(x) } //more than one method of the same name but
//each having different numbers of parameters

def b( a, b=2 ){ "$a, $b" } //last argument/s assigned default values
def c( arg, Object[] extras ){ arg + extras.inject(0){ flo, it-> flo+it } }
def gcd( m, n ){ if( m%n == 0 )return n; gcd(n,m%n) }
//recursion by calling own name
}
def u=new U()
assert u.a(7){ it*it } == 49 //shorthand passing of closures as parameters
assert u.b(7, 4) == '7, 4'
assert u.b(9) == '9, 2'
assert u.c(1,2,3,4,5) == 15 //varying number of arguments using Object[]
assert u.gcd( 28, 35 ) == 7
u.setCount(91)
assert u.getCount() == 91

```

A class can have both static and instantiable parts by using the static keyword on the definitions that are static and not using it on those that are instantiable:

```

class Dice{
//here is the static portion of the class...
static private count //doesn't need a value
static{ println 'First use'; count = 0 }
static showCount(){ return count }

//and here is the instantiable portion...
def lastThrow
Dice(){ println 'Instance created'; count++ }

//static portion can be used by instantiable portion, but not vice versa
def throw(){
lastThrow = 1+Math.round(6*Math.random()) //random integer from 1 to 6
return lastThrow
}
}
d1 = new Dice() //'First use' then 'Instance created' printed
d2 = new Dice() //'Instance created' printed
println "Dice 1: ${ (1..20).collect{d1.throw()} }"
println "Dice 2: ${ (1..20).collect{d2.throw()} }"
println "Dice 1 last throw: $d1.lastThrow, dice 2 last throw: $d2.lastThrow"
println "Number of dice in play: ${Dice.showCount()}"

```

A class can have more than one constructor:

```

class A{
def list= []
A(){
list<< "A constructed"
}
A(int i){
this()
//a constructor can call another constructor if it's the first statement
list<< "A constructed with $i"
}
A(String s){
this(5)
list<< "A constructed with '$s'"
}
}
def a1= new A()
assert a1.list == ["A constructed"]

def a2= new A(7)
assert a2.list.collect{it as String} == [
"A constructed",
"A constructed with 7",
]

def a3= new A('bird')
assert a3.list.collect{it as String} == [
"A constructed",
"A constructed with 5",
"A constructed with 'bird'",
]

```

Categories

When a class has a category method, that is, a static method where the first parameter acts like an instance of the class, we can use an alternative 'category' syntax to call that method:

```

class View{
def zoom= 1
def produce(str){ str*zoom }
static swap(self, that){ //first parameter acts like instance of the class
def a= self.zoom
self.zoom= that.zoom
that.zoom= a
}
}
def v1= new View(zoom: 5), v2= new View(zoom: 4)
View.swap( v1, v2 ) //usual syntax
assert v1.zoom == 4 && v2.zoom == 5
use(View){ v1.swap( v2 ) } //alternative syntax
assert v1.zoom == 5 && v2.zoom == 4
assert v1.produce('a') == 'aaaaa'

```

We can also use category syntax when the category method/s are in a different class:

```

class View{
static timesCalled= 0 //unrelated static definition
def zoom= 1
def produce(str){ timesCalled++; str*zoom }
}
class Extra{
static swap(self, that){ //first parameter acts like instance of View class
def a= self.zoom
self.zoom= that.zoom
that.zoom= a
}
}

```

```

def v1= new View(zoom: 5), v2= new View(zoom: 4)
use(Extra){ v1.swap( v2 ) }
//alternative syntax with category method in different class
assert v1.zoom == 4 && v2.zoom == 5
assert v1.produce('a') == 'aaaa'

```

Many supplied library classes in Groovy have category methods that can be called using category syntax. (However, most category methods on Numbers, Characters, and Booleans do not work with category syntax in Groovy-1.0)

```

assert String.format('Hello, %1$s.', 42) == 'Hello, 42.'
use(String){
assert 'Hello, %1$s.'.format(42) == 'Hello, 42.'
}

```

Far more common are supplied library classes having category methods in another utility class, eg, List having utilities in Collections:

```

def list= ['a', 7, 'b', 9, 7, 7, 2.4, 7]
Collections.replaceAll( list, 7, 55 ) //normal syntax
assert list == ['a', 55, 'b', 9, 55, 55, 2.4, 55]

list= ['a', 7, 'b', 9, 7, 7, 2.4, 7]
use(Collections){
list.replaceAll(7, 55) //category syntax
}
assert list == ['a', 55, 'b', 9, 55, 55, 2.4, 55]

```

We can call category methods inside other category methods:

```

class Extras{
static f(self, n){ "Hello, $n" }
}
class Extras2{
static g(self, n){
Extras.f(self, n)
}
static h(self, n){
def ret
use(Extras){ ret= self.f(n) } //call Extras.f() as a category method
ret
}
}
assert Extras.f(new Extras(), 4) == 'Hello, 4'
assert Extras2.g(new Extras2(), 5) == 'Hello, 5'
assert Extras2.h(new Extras2(), 6) == 'Hello, 6'

class A{ }
def a= new A()
use(Extras){
assert a.f(14) == 'Hello, 14'
}
use(Extras2){
assert a.g(15) == 'Hello, 15'
assert a.h(16) == 'Hello, 16' //call category method within another
}

```

But we can't call category methods inside another category method from the same class:

```

class Extras{
static f(self, n){ "Hello, $n" }
static g(self, n){ f(self, n) }
static h1(self, n){ f(n) } //calling f without first parameter only valid
//when called within a category method
static h2(self, n){
def ret
use(Extras){

```

```

ret= self.f(n)
} //class as category within itself only valid if method wasn't called
//using category syntax
ret
}
}
assert Extras.f(new Extras(), 4) == 'Hello, 4'
assert Extras.g(new Extras(), 5) == 'Hello, 5'
try{ Extras.h1(new Extras(), 6); assert 0 }
catch(e){ assert e instanceof MissingMethodException }
assert Extras.h2(new Extras(), 7) == 'Hello, 7'

class A{ }
def a= new A()
use(Extras){
assert a.f(14) == 'Hello, 14'
assert a.g(15) == 'Hello, 15'
assert a.h1(16) == 'Hello, 16'
try{ a.h2(17); assert 0 }
catch(e){ assert e instanceof GroovyRuntimeException }
}

```

A lot of entities in Groovy are classes, not just the explicit ones we've just learnt about. Numbers, lists, sets, maps, strings, patterns, scripts, closures, functions, and expandos are all implemented under the hood as classes. Classes are the building block of Groovy.

JN2535-Control

This page last changed on Aug 30, 2007 by [gavingrover](#).

A Groovy script is a sequence of statements:

```
def a= 1
assert "a is $a" == 'a is 1'
def b= 2; assert "b is $b" == 'b is 2'
//if two statements on one line, separate by semicolons
def c= 3; ; def d= 4 //empty statement in between
```

When defining classes, we can provide 'asType' methods to convert the class into another using the 'as' operator. Classes we've seen in previous tutorials that convert to another using 'as' (eg, Integer, BigDecimal, String) use the 'asType' method under the hood:

```
class A{
def x
Object asType(Class c){
if(c == B) return new B(x:x*3)
}
}
class B{
def x
}

def a= new A(x:3)

def b1= a.asType(B)
assert b1.class == B && b1.x == 9

def b2= a as B //more common, shortcut syntax for asType()
assert b2.class == B && b2.x == 9
```

We can use 'as' to convert a list into a class instance using the list elements as constructor arguments:

```
class A{
int x,y
A(x,y){ this.x=x; this.y=y }
String toString(){ "x: $x; y: $y" }
}
def a= [1,2] as A
assert a.class == A && a.toString() == 'x: 1; y: 2'
```

Conditional Statements

The if and if-else statements let us choose subsequent statements to execute based on a condition:

```
def x= 7
if( x > 4 ){ println 'x is greater than 4' } //if-statement (no 'else' clause)

if( x > 4 ) println 'x is greater than 4'
//curlies optional if only one statement
//if-else statement...
if( x > 4 ){
println 'x is greater than 4'
}else{
println 'x is less than or equal to 4'
}

if( x > 8 ) println 'x is greater than 8'
//again, curlies optional if only one statement
else println 'x is less than or equal to 8'

//an 'else' clause always belongs to
def result
if( x > 4 )
```

```

if( x > 8 ) result= 'x is greater than 8'
else result= 'x is less than or equal to 8'
//a single 'else' with two 'if' clauses belongs to the innermost
assert result == 'x is less than or equal to 8'

```

The meaning of the 'in' operator depends whether its context in the code is conditional or iterative. When in a conditional context, the 'isCase' method of the target is invoked:

```

class A{
boolean isCase(Object o){
if(o == 'A') return true
else return false
}
}

def a= new A()

assert a.isCase('A')
assert 'A' in a //more common, shortcut syntax for isCase()

assert ! (a.isCase('Z'))
assert ! ('Z' in a) //more common, shortcut syntax for isCase()

```

The switch statement inspects an expression and resumes execution from the first matching case-expression, ie, regex matched, list or set or range contained in, class an instance of, or object equal to:

```

def values= [
'abc': 'abc',
'xyz': 'list',
18: 'range',
31: BigInteger,
'dream': 'something beginning with dr',
1.23: 'none',
]
values.each{
def result
switch( it.key ){
case 'abc': //if switched expression matches case-expression, execute all
//statements until 'break'
result= 'abc'
break
case [4, 5, 6, 'xyz']:
result= 'list'
break
case 'xyz': //this case is never chosen because 'xyz' is matched by
//previous case, then 'break' executed
result= 'xyz'
break
case 12..30:
result= 'range'
break
case Integer:
result= Integer //because this case doesn't have a 'break', result
//overwritten by BigInteger in next line
case BigInteger:
result= BigInteger
break
case ~/dr.*\/:
result= 'something beginning with dr'
break
default:
result= 'none'
}
assert result == it.value
}
}

```

When we supply our own values in the case-expression, the 'isCase' method is invoked to determine whether or not the switch-expression is matched. If there's no 'isCase' method, the 'equals' method is used to test for equality:

```
class A{
boolean isCase(Object switchValue){ //'isCase' method used for case-expression
if(switchValue == 'Hi') return true
else return false
}
}
switch( 'Hi' ){
case new A():
assert true
break
default:
assert false
}

class B{
boolean equals(Object switchValue){ //'equals' method used for case-expression
this.class == switchValue.getClass()
}
}
switch( new B() ){
case new B():
assert true
break
default:
assert false
}
}
```

Iterative Statements

The while statement lets us iterate through a block of code:

```
def x= 0, y= 0
while( x < 5 ){
x++
y += x
}
assert x == 5 && y == 15

while( x < 10 ) x++ //curlies optional if only one statement
assert x == 10

while( x < 15 ){ //we can break out of a while-loop using 'break'
x++
if( x == 12 ) break
}
assert x == 12

while( x != 15 && x != 18 ){
//we can jump to the next iteration of a while-loop using 'continue'
x++
if( x == 15 ){
x++
continue
}
}
assert x == 18
```

We've already seen the 'each' and other related method calls, which emulate the while-statement at a higher level of abstraction, but with some restrictions: the loop variable isn't available outside the loop, no guarantees are made about the order of iteration through the collection, and the 'break', 'continue', and 'return' commands aren't available:

```

int n=1
while( n <= 5 ){
def y= 0
(1..n).each{ //loop variable, here 'it', not available outside loop
y += it
//if( y > 8 ) break
//a syntax error when uncommented: 'break' command not available here
}
assert y == (n+1)*(n/2.0) //another way to add the numbers 1 to n
n++
}

```

Other method calls that loop are 'times', 'upto', 'downto', and 'step'. Like 'each', they don't allow 'break', 'continue', and 'return' commands, but do make guarantees about the order of iteration:

```

def a= 2
3.times{
a= a*a
}
assert a == 256

def list= []
1.upto(5){
list<< it
}
assert list == [1, 2, 3, 4, 5]

list= []
5.3.downto(2.1){ //'upto', 'downto', and 'step' also work with decimal numbers
list<< it
}
assert list == [5.3, 4.3, 3.3, 2.3]

list= []
1.step(9.5, 2.5){
list<< it
}
assert list == [1, 3.5, 6, 8.5]

```

We can label any statement with a name. Labelling a while loop lets any arbitrarily deep nested statement break out of or continue on from it:

```

yonder: def d= 4
there: {
def e= 5
here: if( e == 5 ){
def f= 6
there: def g= 7 //label can repeat a previously-used outer label
}
}
there: def h= 8
//label can repeat a previously-used label at same syntactic level

def i=0, j=0
outer: while( i<5 ){ //labelling a while loop is especially useful...
j= 0
i++
while( j<5 ){
j++
if( i==3 && j==2 ) break outer
//...because we can break out of a specified labelled while loop
}
}
assert i==3 && j==2

def outer= 0, inner= 0

```

```

outer: while( outer != 5 && outer != 8 ){
//label can have same name as any variables
inner= 0
outer++
while( inner<5 ){
inner++
if( outer==5 ){
outer++
continue outer
//we can also continue on from a specified labelled while loop
}
}
}
assert outer==8

```

For-Statements

For-statements are complex yet powerful iterative statements with many possible formats. When 'in' is used in the iterative context of a for-statement, the 'iterator' method of the target is invoked. The 'iterator' method must return an Iterator, defining at least the 'hasNext' and 'next' methods:

```

class CountToFive{
def n= 0
def iterator(){
[ hasNext: { n<5 },
next: { n++ },
] as Iterator
}
}

def list= []
def counter= new CountToFive()
for(int i in counter){
list<< i
}
assert list == [0, 1, 2, 3, 4]

```

The for-statement works with many kinds of objects (eg, Collection, array, Map, String, regex, File, Reader, InputStream, etc):

```

def list= []
for( e in [0, 1, 2, 3, 4] ){ //iterate over a list
list<< e
}
assert list == [0, 1, 2, 3, 4]

list= []
for( i in 1..9 ){ //iterate over a range
list<< i
}
assert list == [1, 2, 3, 4, 5, 6, 7, 8, 9]

list= []
for( e in (3..6).toArray() ){ //over an array
list<< e
}
assert list == [3, 4, 5, 6]

list= []
for( e in ['abc':1, 'def':2, 'xyz':3] ){ //over a map
list<< e.value
}
assert list as Set == [1, 2, 3] as Set

list= []
for( v in [1:'a', 2:'b', 3:'c'].values() ){ //over values in a map

```

```
list<< v
}
assert list as Set == ['a', 'b', 'c'] as Set
```

```
list = []
for( c in "abc" ){ //over the chars in a string
list<< c
}
assert list == ['a', 'b', 'c']
```

We can use 'break' and 'continue' within a for-loop using 'in':

```
def list = []
for( c in 'abc' ){
list<< c
if( c == 'b' ) break
}
assert list == ['a', 'b']
```

```
list = []
for( c in 'abc' ){
if( c == 'b' ) continue
list<< c
}
assert list == ['a', 'c']
```

'each' methods can also be considered as emulating for-loops at a higher level of abstraction, without the guarantees about the order of iteration, and the 'break', 'continue', and 'return' commands being unavailable:

```
def list= []
['a', 'b', 'c'].each{
list<< it
}
assert list == ['a', 'b', 'c']
```

```
//instead of...
list= []
for( item in ['a', 'b', 'c'] ){
list<< item
}
assert list == ['a', 'b', 'c']
```

Another format for the for-statement is the initializer-condition-incrementer format:

```
def list= []
for(def i=0; i<5; i++){
//first value an initializer, second a condition, third an incrementer
list<< i
}
assert list == [0, 1, 2, 3, 4]
```

```
//equivalent while-statement...
list= []
try{
def i=0 //initializer
while( i<5 ){ //condition
list<< i
i++ //incrementer
}
}
assert list == [0, 1, 2, 3, 4]
```

```
//for-statement with 'break'
list= []
for(def i=0; i<5; i++){
list<< i
```

```

if( i == 2 ) break
}
assert list == [0, 1, 2]

//equivalent while-statement with 'break'
list= []
try{
def i=0
while( i<5 ){
list<< i
if( i == 2 ) break
i++
}
}
assert list == [0, 1, 2]

//for-statement with 'continue'
list= []
for(def i=0; i<5; i++){
if( i == 2 ){ i++; continue }
//the incrementer isn't executed automatically when we 'continue'
list<< i
}
assert list == [0, 1, 3, 4]

//equivalent while-statement with 'continue'
list= []
try{
def i=0
while( i<5){
if( i == 2 ){ i++; continue }
list<< i
i++
}
}
assert list == [0, 1, 3, 4]

```

We can have more than one initializer, and more than one incremter:

```

//two initializers and two incremterers...
def list= []
for(def i=0; def j=10; i<5; i++; j++){ //the middle expression is the condition
list<< i + j
}
assert list == [10, 12, 14, 16, 18]

//three initializers and three incremterers...
list= []
for(def i=0; def j=10; def k=20; i<3; i++; j++; k++){
list<< i + j + k
}
assert list == [30, 33, 36]

//when there's an even number of expressions, the condition is just before
//the middle...
list= []
try{
def i=0
for(def j=10; i<5; i++; j++){
list<< i + j
}
}
assert list == [10, 12, 14, 16, 18]

//we can force in more initializers than incremterers by using
//'null' statements...

```

```
list= []
for(def i=0; def j=10; i<5; i++; null ){
list<< i + j
}
assert list == [10, 11, 12, 13, 14]
```

Operator Overloading

The precedence heirarchy of the operators, some of which we haven't looked at yet, is, from highest to lowest:

```
$(scope escape)
new ()(parentheses)
[](subscripting) ()(method call) {}(closable block) [](list/map)
. ?. *. (dots)
~ ! $ ()(cast type)
**(power)
++(pre/post) --(pre/post) +(unary) -(unary)
* / %
+(binary) -(binary)
<< >> >>> .. ..<
< <= > >= instanceof in as
== != <=>
&
^
|
&&
||
?:
= **= *= /= %= += -= <<= >>= >>>= &= ^= |=
```

We've seen how the 'as' operator is mapped to the asType() method, and how the 'in' operator is mapped to the isCase() and iterator() methods. Many more operators have equivalent method names. We've seen how [] subscripting has equivalent methods getAt() and putAt() in the HashMap class. They are also equivalent when we define such methods on our own classes:

```
class A{
int key
def value
def getAt(int n){ if(key == n) return value }
void putAt(int n, def o){ key= n; value= o }
}
def a= new A()
a[1]= 'abc' //calls putAt()
assert a[1] == 'abc' //calls getAt()
assert a[2] == null
```

We've also seen how various operators have equivalent method names in the numerical classes, such as Integer, BigDecimal, float, etc. They, too, are also equivalent when we define such methods on our own classes:

```
class OddNumber{ //only gives odd results to operations, adding 1 if necessary
int value
OddNumber(int n){ value= (n%2)? n: n+1 }

def power(int n){ value**n }
def multiply(int n){ def i= value*n; (i%2)? i: i+1 }
def div(int n){ int i= value/n; (i%2)? i: i+1 }
def mod(int n){ int i= value - div(n)*n; (i%2)? i: i+1 }
def plus(int n){ int i= value + n; (i%2)? i: i+1 }
def minus(int n){ int i= value - n; (i%2)? i: i+1 }

def and(int n){ n == value }
def or(int n){ n == value || (n == value-1) }
def xor(int n) {n == value-1 }
```



```

def leftShift(int n){ value= (n%2)? n: n+1 }
def rightShift(int n){ (value * 10**n) + 1 }
def rightShiftUnsigned(int n){ (value * 10**(n*2)) + 1 }

def next(){ new OddNumber(value + 2) }
def previous(){ new OddNumber(value - 2) }
}
def e= new OddNumber(6)
assert e.value == 7

assert e**3 == 343 //calls power()
assert e*4 == 29 //calls multiply()
assert e/3 == 3 //calls div()
assert e%3 == -1 //calls mod()
assert e+5 == 13 //calls plus()
assert e-1 == 7 //calls minus()

assert e & 7 //calls and()
assert e | 6 && e | 7 //calls or()
assert e ^ 6 //calls xor()

e<< 2 //calls leftShift()
assert e.value == 3

assert e>>2 == 301 //calls rightShift()
assert e>>>2 == 30001 //calls rightShiftUnsigned()

assert (e++).value == 3 //calls next()
assert e.value == 5
assert (++e).value == 7
assert e.value == 7

assert (e--).value == 7 //calls previous()
assert e.value == 5
assert (--e).value == 3
assert e.value == 3

```

JN3015-Types

This page last changed on Aug 30, 2007 by [gavingrover](#).

We can restrict the types of values a variable may hold by specifying some restricting class instead of 'def':

```
import org.codehaus.groovy.runtime.typehandling.GroovyCastException

def v= 3 //variable v can hold any value
v= 'helicopter'
v= false
v= new StringBuffer()
v= null

int i= 15 //variable i can only hold integer values
i= 'A'
assert i == 65 //'A' casted to its integer value

//unable to cast boolean value to integer
try{ i= false; assert 0 }catch(e){ assert e in GroovyCastException }

Closure c= {it * 3} //variable c can only hold Closures
try{ c= false; assert 0 }catch(e){ assert e in GroovyCastException }
//unable to cast boolean value to Closure

StringBuffer s= new StringBuffer('morning')
//variable s can only hold StringBuffers
try{ s= { it * 5 }; assert 0 }catch(e){ assert e in GroovyCastException }
//unable to cast Closure value to StringBuffer
```

When we assign values not of a variable's type to the variable, sometimes it may be 'cast' to the type, other times an exception is thrown:

```
import org.codehaus.groovy.runtime.typehandling.GroovyCastException

int i
i= 45L; assert i == 45i
i= 45.1f; assert i == 45i
try{ i= '42'; assert 0 }catch(e){assert e in GroovyCastException}
try{ i= false; assert 0 }catch(e){assert e in GroovyCastException}

//long similar to int

byte by
by= 200i; assert by == -56

//short similar to byte

float f
f= 123i; assert f == 123.0f
try{ f= '42.1'; assert 0 }catch(e){assert e in GroovyCastException}

//double similar to float

BigInteger bi
bi= 42L; assert bi == 42g
try{ bi= '421'; assert 0 }catch(e){assert e in GroovyCastException}

BigDecimal bd
bd= 42.1f; assert bd == 42.1g
try{ bd= '4.21'; assert 0 }catch(e){assert e in GroovyCastException}

boolean b
b= 0; assert ! b
b= 1i; assert b
b= 1g; assert b
```

```

b= 1.1g; assert b
b= 1.1f; assert b
b= ''; assert ! b
b= 'a'; assert b
b= 'abc'; assert b
b= null; assert ! b

char c
c= 'a'; assert c == ('a' as char)
try{ c= 'abc'; assert 0 }catch(e){assert e in GroovyCastException}

String s
s= 42i; assert s == '42'
s= 42L; assert s == '42'
s= 42g; assert s == '42'
s= 42.lg; assert s == '42.1'
s= 42.100g; assert s == '42.100'
s= 42.1f; assert s == '42.1'

StringBuffer sb
try{ sb= 'abc'; assert 0 }catch(e){ assert e in GroovyCastException }

```

We can statically type Closure parameters. The casting is more restrictive than for assigning to variables:

```

import org.codehaus.groovy.runtime.typehandling.GroovyCastException

int i
def toTriple= {int n -> n * 3}
i= 5
assert toTriple(5) == 15

//a float is cast to an integer when assigning to a variable, but not when
//passing as a parameter...
i= 5.0f
try{ toTriple(5.0f); assert 0 }
catch(e){assert e.class in MissingMethodException}

//a String can't cast to an integer, either when assigning to a variable or
//passing as a parameter...
try{ i= 'abc'; assert 0 }
catch(e){assert e.class in GroovyCastException}
try{ toTriple('abc'); assert 0 }
catch(e){assert e.class in MissingMethodException}

```

We can also statically type the variable-numbered parameters in a closure:

```

def c = { int[] args ->
args.toList().inject(0){ flo, it-> flo + it }
}
assert c( 5 ) == 5
assert c( 4, 2, 3 ) == 9
try{ c( 2, 'abc' ); assert 0 }catch(e){ assert e in MissingMethodException }

```

We can statically type function parameters:

```

def f(String s, int i){ ([s]*i).join(',') }
assert f('abc', 3) == 'abc,abc,abc'

def f(int n, int i){ "$n * $i" } //another function f defined with same
//number of but different types of parameters
assert f(4, 5) == '4 * 5'
assert f('a', 5) == 'a,a,a,a,a'
//correct function selected based on parameter types...
try{ f(4, 'x'); assert 0 }catch(e){ assert e in MissingMethodException }
//...or no method selected

```

We can statically type the return type from a function. Casting a returned value of a different type follows the same rules as for assigning to variables:

```
String f(){ 'abc' }
assert f() == 'abc'

int g(){ 2.4f }
assert g() == 2i
```

We can statically type method parameters just like we do with function parameters, including selecting a method based on its parameter types, for both static methods and instance methods:

```
//static methods...
class A{
static f(String s, int i){ ([s]*i).join(',') }
static f(int n, int i){ "$n * $i" } //another method f defined with same
//number of but different types of parameters
}
assert A.f('abc', 3) == 'abc,abc,abc'
assert A.f(4, 5) == '4 * 5'
assert A.f('a', 5) == 'a,a,a,a,a'
//correct method selected based on parameter types...
try{ A.f(4, 'x'); assert 0 }catch(e){ assert e in MissingMethodException }
//...or no method selected

//instance methods...
class Counter{
def count = 0
def incr( String n ){ count += new Integer(n) }
def incr( int n ){ count += n }
}
def c= new Counter(count: 5)
c.incr(3)
c.incr('4')
try{ c.incr(2.5); assert 0 }catch(e){ assert e in MissingMethodException }
assert c.count == 12
```

We can statically type the return type from a method, just as we can from a function, both static and instance methods:

```
class A{
static String f(){ 'abc' }
static int g(){ 2.4f }
byte h(){ 200i }
}
assert A.f() == 'abc'
assert A.g() == 2i
assert new A().h() == -56
```

Property getters and setters can accept and return any statically-typed value:

```
class Counter{
def count= 0
void setCount(int n){ count= n*2 } //set the value to twice what's supplied
String getCount(){ 'count: '+ count }
//return the value as a String with 'count: ' prepended
}
def c= new Counter()
c.count= 23
assert c.count == 'count: 46'
```

A list can be cast to a class using that class's constructor:

```
class A{
int x,y
A(x,y){ this.x=x; this.y=y } //2-arg constructor
String toString(){ "x: $x; y: $y" }
```

```

}
A a
a= [1,2] //2-element list causes 2-arg constructor of A to be called
assert a.class == A && a.toString() == 'x: 1; y: 2'

```

Statically-Typed Arrays

We can statically type an Object array variable:

```

Object[] oa= new Object[2]
assert oa.class in Object[] && oa.size() == 2 && oa[0,1] == [null, null]

oa= 7 //if we assign another scalar value, it's wrapped into an array
assert oa.class in Object[] && oa.size() == 1 && oa[0] == 7

oa= [3, 5] //if we assign another collection value, it's cast to an array
assert oa.class in Object[] && oa.size() == 2 && oa[0,1] == [3, 5]

def map= ['a':4, 'b':8, 'c':12]
oa= map
assert oa.class in Object[] && oa.size() == 3
//it's cast to an array of MapEntry's
oa.each{ assert it.key in map.keySet() && it.value == map[it.key] }

```

We can statically type a variable not only as an array, but as a certain type of array:

```

int[] ia
ia= 7.5
assert ia.class in int[] && ia.size() == 1 && ia[0] == 7i
//assigned value above cast to an integer array

try{ ia= ['abc', 'def']; assert 0 }catch(e){ assert e in ClassCastException }
//can't cast Strings to Integers

```

We can instead statically type each array element:

```

def a= new int[3]
assert a[0] == 0 && a[1] == 0 && a[2] == 0 //default value is 0

a[0]= 7.5
assert a[0] == 7i //assigned value in above line was cast to an integer

try{ a[1]= 'abc'; assert 0 }catch(e){ assert e in ClassCastException }
//can't cast String to an Integer

```

Statically typing both the variable and each element allows both array assignments and element assignments to be cast or disallowed:

```

int[] ia= new int[3]
ia[0]= 7.5
assert ia[0] == 7i
ia= 7.5
assert ia.class in int[] && ia.size() == 1 && ia[0] == 7i

```

A multidimensional array type casts its assigned value in various ways:

```

//a scalar value is cascadingly wrapped by arrays...
Object[][] ia
ia= 7.5
assert ia in Object[][] && ia.size() == 1 &&
ia[0] in Object[] && ia[0].size() == 1 &&
ia[0][0] == 7.5

//a one-dimensional vector value is array-wrapped at the innermost level...
ia= ['a', 'b', 'c']
assert ia in Object[][] && ia.size() == 3 &&
ia[0] in Object[] && ia[0].size() == 1 &&

```

```
ia[0][0] == 'a' && ia[1][0] == 'b' && ia[2][0] == 'c'
```

Interfaces

Groovy enables a construct known as an interface, which classes can implement. We can test for implemented interfaces with the 'in' operator:

```
class A{} //a standard class definition, though without any fields,
//properties, or methods
def a= new A()
assert a in A

interface X{}
class B implements X{} //a class can implement an interface
def b= new B()
assert b in B && b in X
//'in' tests for the class and for interfaces implemented
assert !(a in X)

interface Y{}
interface Z{}
class C implements X, Y, Z{} //a class can implement more than one interface
def c= new C()
assert c in C && c in X && c in Y && c in Z
```

Interfaces can contain method declarations. Each declared method must be defined in implementing classes:

```
interface X{
String sayPies(int i)
}

class A implements X{
String sayPies(int n){ "There are $n pies!" } //sayPies(int) in X defined
String sayBirds(int n){ "There are $n birds!" }
}
def a= new A()
assert a.sayPies(24) == 'There are 24 pies!'

//class B implements X{}
//a compile error when uncommented: sayPies(int) must be implemented

//these each give a compile error when uncommented...
//class C implements X{ String sayPies(float n){ "$n" } } //wrong parameter type
//class D implements X{ Object sayPies(int n){ "$n" } } //wrong return type
```

An interface can also be composed of other interfaces, using the 'extends' keyword:

```
interface X{
def x1(int i)
def x2()
}
interface Y{
def x1(int i)
def y()
}
interface Z extends X, Y{ }
//it's OK if a method, here x1(int), is in more than one interface

class A implements Z{
def x1(int i){ i }
def x2(){ 2 }
def y(){ 3 }
}
assert new A().x1( 1 ) == 1
```

We can implement an interface with map syntax:

```
interface X{
int echo(int i)
def sayTarts(int i)
String sayPies(int i)
}
def a= [
echo: {n-> n},
sayTarts: {n-> "There are $n tarts!"},
sayPies: {n-> "There are $n pies!" as String},
//explicit cast from GString to String required here
] as X

assert a.echo(12) == 12
assert a.sayTarts(18) == 'There are 18 tarts!'
assert a.sayPies(24) == 'There are 24 pies!'

//when interface has only one method, we don't need a map, but can assign and
//cast the closure directly...
interface Y{
def sayCakes(int i)
}
def b= {n-> "There are $n cakes!"} as Y

assert b.sayCakes(36) == 'There are 36 cakes!'
```

Interfaces can also have fields, but their values can't be changed:

```
interface X{
int status= 1 //constant field on interface
int changeCounter()
}
class A implements X{
int counter= 1 //updateable field on class itself
int changeCounter(){ counter++ }
int changeStatus(){ status++ }
}
def a= new A()
a.changeCounter() //field 'counter' can be changed...
try{ a.changeStatus(); assert 0 }catch(e){ assert e in IllegalAccessException }
//...but field 'status' can't
```

Static Typing with Interfaces

We can use an interface, instead of a class, to statically type a variable, field, parameter, etc:

```
import org.codehaus.groovy.runtime.typehandling.GroovyCastException

interface X{}
class A implements X{}
class B{}
X a
a= new A()
try{ a= new B(); assert 0 }catch(e){ assert e in GroovyCastException }
```

Groovy supplies many interfaces we can use to statically type variables. Some have no methods, eg, `Serializable`, while others have one or more:

```
class A implements Serializable{}
//Serializable interface marks class A via the 'in' operator
assert A in Serializable

//class B implements Closeable{}
//compile error when uncommented: method close() must be defined
```

```

class C implements Closeable{
void close(){}
//Closeable interface signifies that this close() method is present
}
def c= new C()
if( c in Closeable ) c.close()

```

We've met the Comparator interface in the tutorial on Collections, and the Iterator interface in the tutorial on Control Structures.

Many Groovy classes we've met implement interfaces, which we can use to statically type variables:

```

import org.codehaus.groovy.runtime.typehandling.GroovyCastException

List list1= new ArrayList(),
list2= [],
list3= new LinkedList()
assert list1 in ArrayList &&
list2 in ArrayList &&
list3 in LinkedList

Set set1= new HashSet(),
set2= list1,
set3= list3,
set4= new TreeSet()
assert [set1, set2, set3].every{ it in HashSet } &&
set4 in TreeSet

SortedSet ssl= new TreeSet(),
ss2
try{ ss2= new HashSet(); assert 0 }catch(e){ assert e in GroovyCastException }

Map map1= new HashMap(),
map2= new TreeMap(),
map3= [:],
map4= new LinkedHashMap()
assert map1 in HashMap &&
map2 in TreeMap &&
[map3, map4].every{ it in LinkedHashMap }

SortedMap sm1= new TreeMap(),
sm2
try{ sm2= new HashMap(); assert 0 }catch(e){ assert e in GroovyCastException }

```

JN3025-Inheritance

This page last changed on Aug 30, 2007 by [gavingrover](#).

Groovy enables one class to extend another, just as interfaces can, though classes extend at most one class. We can test for extended classes with the 'in' operator, just like with implemented interfaces:

```
class A{}
class B extends A{}
def b= new B()
assert b in B && b in A

class A1{}
class A2{}
//class C extends A1, A2{}
//compile error when uncommented: a class can extend at most one class
```

Public instance fields, properties, and methods defined on an extended class are also available on the extending class:

```
class A{
public int prev //field
int signature //property
String sayPies(int n){ "There are ${prev= signature= n} pies!" } //method
}
class B extends A{
String sayBirds(int n){ "There are $n birds!" }
}
def b= new B()
assert b.sayBirds(17) == 'There are 17 birds!'
assert b.sayPies(11) == 'There are 11 pies!'
//method sayPies(int) from A acts as part of B
assert b.prev == 11 //field 'prev' from A acts as part of B
b.signature= 19
assert b.signature == 19 //property 'signature' from A acts as part of B
assert b.getSignature() == 19
```

We can use the 'private' and 'protected' modifiers to restrict the visibility of instance methods, properties, and fields:

```
class A{
//private methods, properties, and fields are not visible outside the class,
//even in inheriting classes...
private int prevPies
private String sayPies(int n){ "There are ${prevPies= n} pies!" }

//protected methods, properties, and fields are visible in inheriting
//classes (and within the same package)...
protected int prevBeans
protected String sayBeans(int n){ "There are ${prevBeans= n} beans!" }
}
class B extends A{
def testAccesses(){
assert sayPies(23) == 'There are 23 pies!'
//Groovy bug: this private method shouldn't be visible here
try{ prevPies; assert 0 }catch(e){ assert e in MissingPropertyException }
//A's private field 'prevPies' not visible here

assert sayBeans(29) == 'There are 29 beans!'
//A's protected method visible here in an inheriting class
assert prevBeans == 29
//A's protected field visible here in an inheriting class
}
}
def b= new B()
assert b.sayPies(11) == 'There are 11 pies!'
//Groovy bug: this private method shouldn't be visible here
```

```

try{ b.prevPies; assert 0 }catch(e){ assert e in MissingPropertyException }
//A's private field 'prevPies' not visible here

assert b.sayBeans(14) == 'There are 14 beans!'
//this protected method is visible here in the same package it's defined in
assert b.prevBeans == 14
//this protected field is visible here in the same package it's defined in

b.testAccesses()

```

Public static fields, properties, and methods are inherited by extending classes:

```

class A{
static public int numBananas //field
static signature //property
static String sayBananas(int n){ //method
"There are ${numBananas= signature= n} bananas!"
}
}
class B extends A{}

assert A.sayBananas(23) == 'There are 23 bananas!' //method call
assert A.numBananas == 23 //field access
assert A.signature == 23 //property accesses
assert A.getSignature() == 23

assert B.sayBananas(23) == 'There are 23 bananas!' //method call

assert B.numBananas == 23 //field access
assert B.signature == 23 //property access
B.getSignature() == 23 //property access using method syntax

```

We can make static methods, properties, and fields private or protected:

```

class A{
static private int numBananas= 0
static private String sayBananas(int n){
"There are ${numBananas= n} bananas!"
}
static protected int numApples= 0
static protected String sayApples(int n){
"There are ${numApples= n} apples!"
}
}
class B extends A{
static testAccesses(){
assert sayBananas(37) == 'There are 37 bananas!'
//numBananas //compile error when uncommented:
//A's private field not visible here

assert sayApples(29) == 'There are 29 apples!'
//numApples //compile error when uncommented:
//A's protected field not visible here in an inheriting class
}
}
assert B.sayBananas(31) == 'There are 31 bananas!'
try{ B.numBananas; assert 0 }catch(e){ assert e in MissingPropertyException }
assert B.sayApples(23) == 'There are 23 apples!'
assert B.numApples == 23

B.testAccesses()

```

We can define what's called an "abstract class", a class with only some methods defined, the others being only declarations just like in interfaces. An abstract class and each method declaration in it must be modified with the keyword 'abstract':

```

interface X{

```

```

def x()
}
interface Y{
def y()
}
abstract class A{
def a(){ println 1 } //method definition
abstract b() //declaration of method only
}
class B extends A implements X, Y{
def x(){ println 2 }
def y(){ println 3 }
def b(){ println 4 } //declared method from abstract class A defined here
}

```

Whether a method is static or not is part of its definition, not its declaration. So interface and abstract methods may not be declared static.

```

interface X{
def x()
//static x1() //error when uncommented: interface methods can not be static
}
interface Y{
def y()
}
abstract class A{
static a(){ println 1 }
abstract b()
abstract c()
//abstract static c1()
//error when uncommented: abstract methods can not be static
}
class B extends A implements X, Y{
static x(){ println 2 }
def y(){ println 3 }
static b(){ println 4 }
def c(){ println 5 }
}

```

At the other end from abstract classes and methods are "final classes" and "final methods". A final class may not be extended; a final method may not be overridden:

```

class A{
final a(){ 11 }
def b(){ 12 }
}
final class B extends A{
//def a(){ 15 } //compile error when uncommented: can not override final A.a()
def b(){ 16 }
}
//class C extends B{} //compile error when uncommented: can not extend final C

```

Constructors

Just as a class's constructor can call another constructor at the beginning of its code, so also it can call a constructor on the superclass at the beginning of its code:

```

class A{
def list= []
A(){
list<< "A constructed"
}
A(int i){
this()
list<< "A constructed with $i"
}
}

```

```

}
class B extends A{
B(){
list<< "B constructed"
}
B(String s){
super(5) //a constructor can call its superclass's constructor if it's
//the first statement
list<< "B constructed with '$s'"
}
}

def b1= new B('kea')
assert b1.list.collect{it as String} == [
"A constructed",
"A constructed with 5",
"B constructed with 'kea'",
]
def b2= new B()
assert b2.list == [
"A constructed",
//default parameterless constructor called if super() not called
"B constructed",
]

```

Using Classes by Extending Them

Some classes supplied with Groovy are intended to be extended to be used. For example, `FilterInputStream`, `FilterOutputStream`, `FilterReader`, and `FilterWriter`:

```

//When not extended, FilterOutputStream simply passes its method calls to the
//wrapped stream...
try{
def fos= new FilterOutputStream(new FileOutputStream('abc.txt'))
fos.write(33i)
fos.write([34,35,36] as byte[])
fos.write([34,35,36,37,38,39,40] as byte[], 3, 2)
fos.close()
def fis= new FilterInputStream(new FileInputStream('abc.txt'))
def ba= new byte[6]
fis.read(ba)
assert ba.toList() == [33,34,35,36,37,38]
}

//We can extend FilterOutputStream to provide the logic for the filter...
class EvenNumberOutputStream extends FilterOutputStream{
EvenNumberOutputStream(OutputStream out){
super(out)
}
def write(int i){
if(i%2 == 0) super.write(i) //call method of same name in the super-class
}
def write(byte[] ba){
super.write( ba.toList().findAll{ it%2 == 0 } as byte[] )
}
def write(byte[] ba, int start, int size){
this.write( ba[start..<(start+size)] as byte[] )
//another way to call method of same name in same class definition
}
}
try{ //...then call the methods...
def fos= new EvenNumberOutputStream(new FileOutputStream('abc.txt'))
fos.write(33i)
fos.write([34,35,36] as byte[])
fos.write([34,35,36,37,38,39,40] as byte[], 3, 2)
fos.close()
}

```

```

def fis= new FilterInputStream(new FileInputStream('abc.txt'))
def ba= new byte[6]
fis.read(ba)
assert ba.toList() == [34,36,38,0,0,0]
}

```

We can similarly extend `FilterInputStream`, `FilterReader`, and `FilterWriter`.

The Object Hierarchy

All classes are arranged in a hierarchy with `java.lang.Object` as the root. Here are those we've met so far; those labelled as such are abstract and final classes:

```

java.lang.Object
java.lang.Boolean (final)
java.lang.Character (final)
java.lang.Number (abstract)
java.lang.Integer (final)
java.lang.Long (final)
java.math.BigInteger
java.math.BigDecimal
java.lang.Short (final)
java.lang.Byte (final)
java.lang.Float (final)
java.lang.Double (final)
java.math.MathContext (final)
java.util.Random
java.util.Date
java.util.TimeZone (abstract)
java.util.SimpleTimeZone
java.util.Calendar (abstract)
java.util.GregorianCalendar
groovy.time.BaseDuration (abstract)
groovy.time.Duration
groovy.time.TimeDuration
groovy.time.DatumDependentDuration
groovy.time.TimeDatumDependentDuration
java.util.AbstractCollection (abstract)
java.util.AbstractList (abstract)
java.util.ArrayList
groovy.lang.Sequence
groovy.lang.IntRange
groovy.lang.ObjectRange
java.util.AbstractSet (abstract)
java.util.HashSet
java.util.TreeSet
java.util.AbstractMap (abstract)
java.HashMap
java.util.LinkedHashMap
groovy.lang.SpreadMap
java.TreeMap
java.util.Collections
java.lang.String (final)
java.lang.StringBuffer (final)
java.util.regex.Pattern (final)
java.util.regex.Matcher (final)
groovy.lang.GroovyObjectSupport (abstract)
groovy.lang.Binding
groovy.lang.Closure (abstract)
groovy.lang.GString (abstract)
groovy.util.Expando
java.text.Format (abstract)
java.text.NumberFormat (abstract)
java.text.DecimalFormat
java.text.DateFormat (abstract)
java.text.SimpleDateFormat

```

```
java.text.DecimalFormatSymbols
java.text.DateFormatSymbols
java.io.File
java.io.InputStream (abstract)
java.io.ByteArrayInputStream
java.io.FileInputStream
java.io.FilterInputStream
java.io.BufferedInputStream
java.io.DataInputStream
java.io.LineNumberInputStream
java.io.PushbackInputStream
java.io.SequenceInputStream
java.io.StringBufferInputStream
java.io.OutputStream (abstract)
java.io.ByteArrayOutputStream
java.io.FileOutputStream
java.io.FilterOutputStream
java.io.BufferedOutputStream
java.io.DataOutputStream
java.io.PrintStream
java.io.Reader (abstract)
java.io.BufferedReader
java.io.LineNumberReader
java.io.CharArrayReader
java.io.FilterReader (abstract)
java.io.PushbackReader
java.io.InputStreamReader
java.io.FileReader
java.io.StringReader
java.io.Writer (abstract)
java.io.BufferedWriter
java.io.CharArrayWriter
java.io.FilterWriter (abstract)
java.io.OutputStreamWriter
java.io.FileWriter
java.io.PrintWriter
java.io.StringWriter
```

JN3035-Exceptions

This page last changed on Aug 22, 2007 by [gavingrover](#).

Exceptions and Errors are together known as Throwables. The Throwables are positioned like so in the Object hierarchy:

```
java.lang.Object
java.lang.Throwable
java.lang.Error
java.lang.Exception
```

Errors are fatalities that we would normally want to cause a program failure, while Exceptions are events that we would normally want to handle in our program. An example of using them with a try-catch statement, a 'try' clause followed by a 'catch' clause:

```
//assert 1 == 0 //AssertionError when uncommented

//try{ assert 1 == 0 }catch(e){}
//AssertionError when uncommented: Exceptions, not Errors, are caught here

try{
  assert 1 == 0
}catch(Error e){}
//by specifying Error, prevents bad assertion from causing program failure

try{
  assert 1 == 0
}catch(Throwable e){} //specifying Throwable also prevents program failure

//try{ assert 1 == 0 }catch(Object o){}
//compile error when uncommented:
//only Throwables and its subclasses may be caught
```

A common idiom for asserting for exceptions is:

```
try{
  'moo'.toLong() //this will generate an exception
  assert false //asserting that this point should never be reached
}catch(e){
  assert e in NumberFormatException
}
```

Some common exceptions associated with Groovy:

```
assert new java.lang.ArithmeticException()
assert new java.lang.ArrayIndexOutOfBoundsException()
assert new java.lang.NullPointerException()
assert new java.io.IOException()
```

We can put code within a 'finally' clause following a matching 'try' clause, so that if the code in the 'try' clause throws an exception, the code in the finally clause will always execute:

```
def z
try{
  def i= 7, j= 0
  try{
    def k= i / j
    assert false //never reached due to Exception in previous line
  }finally{
    z= 'reached here' //always executed even if Exception thrown
  }
}catch(e){
  assert e in ArithmeticException
  assert z == 'reached here'
}
```

We can attach more than one 'catch' clause to a 'try' clause, and attach a 'finally' clause also:

```

class E1 extends Exception{} //we can define our own exceptions
class E2 extends Exception{}
class E3 extends Exception{}

try{
def z

//multi-catch try-block with finally-clause...
try{
throw new E2()
assert false
}catch(E1 e){
assert false
}catch(E2 e){
z= 'reached here'
throw new E3() //uncaught exception because only one catch clause executed
}catch(E3 e){
assert false //never reached
}finally{
assert z == 'reached here'
throw new E1()
assert false
}

}catch(E1 e){} //catches exception thrown in embedded finally clause

```

An exception will ripple up through the nested blocks, executing only code in 'finally' clauses, until caught, or the thread terminates.

```

class MyException extends Exception{}
def z
try{
try{
throw new MyException()
assert false
}
}catch(e){
assert e in MyException
z= 'been here'
}
assert z == 'been here'

```

Exceptions will also ripple through function and method invocations

```

class MyException extends Exception{}

def z= []
def met(){
throw new MyException()
}
try{ met(); assert false }
catch(e){assert e in MyException; z << 'function'}

class M{
def m(){ throw new MyException() }
}
try{ new M().m(); assert false }
catch(e){assert e in MyException; z << 'method' }

def c= { throw new MyException() }
try{ c(); assert false }
catch(e){assert e in MyException; z << 'closure'}

assert z == ['function', 'method', 'closure']

//Method embedded in closure...

```



```
def z2
def d= { new M().m(); assert false }
try{ d(); assert false }
catch(e){assert e in MyException; z2= 'closure d'}
assert z2 == 'closure d'
```

We can mark a function or method indicating what type of Exception it might throw. This is a useful documentation feature:

```
class MyException extends Exception{}
def z= []

def met() throws MyException{ // 'function met() may throw MyException'
throw new MyException()
}
try{ met(); assert false }
catch(e){assert e in MyException; z << 'function'}
```

```
class M{
def m() throws MyException{ // 'method m() of class M may throw MyException'
throw new MyException()
}
}
try{ new M().m(); assert false }
catch(e){assert e in MyException; z << 'method' }
```

```
assert z == ['function', 'method']
```

JN3515-Interception

This page last changed on Aug 30, 2007 by [gavingrover](#).

We can use the ProxyMetaClass to intercept methods in a class within a selected block for the current thread.

Interceptors with ProxyMetaClass

By using ProxyMetaClass, we can attach an interceptor to a class for a block of code. The Groovy-supplied Interceptor interface has three methods. The beforeInvoke() method specifies code to be executed before the intercepted method, the doInvoke() indicates whether to execute the intercepted method, and afterInvoke() executes after the intercepted method finishes, or after a false-returning doInvoke(). The result parameter passed to afterInvoke() is the result of executing the method, or what was returned from beforeInvoke() if the intercepted method wasn't executed. What afterInvoke() returns is returned from the method call in the main flow of the program.

```
class MyClass{
public MyClass(String s){ println "constructing $s" }
public String sayHello(String name){
println "saying hello to $name"
"Hello " + name //return this value
}
}

class MyInterceptor implements Interceptor{
Object beforeInvoke(Object object, String methodName, Object[] arguments){
println " BEFORE $object .$methodName $arguments"
if( methodName == 'sayHello' ) arguments[0] += ' and family'
//we can change the arguments
null //value returned here isn't actually used anywhere else
}
boolean doInvoke(){ true } //whether or not to invoke the intercepted
//method with beforeInvoke's copy of arguments

Object afterInvoke(Object object, String methodName, Object[] arguments,
Object result){
println " AFTER $object .$methodName $arguments: $result"
if( methodName == 'sayHello' ) result= (result as String) + ' and in-laws'
//we can change the returned value
result
}
}

def proxy= ProxyMetaClass.getInstance( MyClass )
//create proxy metaclass for MyClass
proxy.interceptor= new MyInterceptor()
//attach new interceptor to MyClass's proxy metaclass
proxy.use{
def invoice= new MyClass('trade')
println invoice.sayHello('Ms Pearl')
}

/*example output:
BEFORE class MyClass .ctor {"trade"}
constructing trade
AFTER class MyClass .ctor {"trade"}: MyClass@1d63e39
BEFORE MyClass@1d63e39 .sayHello {"Ms Pearl"}
saying hello to Ms Pearl and family
AFTER MyClass@1d63e39 .sayHello {"Ms Pearl and family"}: Hello Ms Pearl and family
Hello Ms Pearl and family and in-laws
*/
```

We can invoke a different method instead of the one called:

```
class MyClass{
```

```

public String sayHello(String name){
println "saying hello to $name"
return "Hello " + name
}
public String sayGoodbye(String name){
println "saying goodbye to $name"
return "Goodbye " + name
}
}

class MyInterceptor implements Interceptor{
def toInvoke= true
//so we can change whether or not to invoke the original method
def resultFromSayGoodBye

Object beforeInvoke(Object object, String methodName, Object[] arguments){
if( object instanceof MyClass && methodName == 'sayHello' ){
resultFromSayGoodBye= object.sayGoodbye(arguments[0])
//so we can invoke a different method
toInvoke= false //don't invoke sayHello
}
}
boolean doInvoke(){ toInvoke }

Object afterInvoke(Object object, String methodName, Object[] arguments,
Object result){
if( object instanceof MyClass && methodName == 'sayHello' ){
toInvoke= true
result= resultFromSayGoodBye
}
result
}
}

//a utility to match up class, interceptor, and code...
def useInterceptor= { Class theClass, Class theInterceptor, Closure theCode->
def proxy= ProxyMetaClass.getInstance( theClass )
def interceptor= theInterceptor.newInstance()
//must use dynamic constructor here because class not yet known
proxy.interceptor= interceptor
proxy.use( theCode )
}

useInterceptor( MyClass, MyInterceptor ){
println new MyClass().sayHello('Ms Pearl')
}

/*output:
saying goodbye to Ms Pearl
Goodbye Ms Pearl
*/

```

We can even use interceptors on predefined Java classes:

```

class MyInterceptor implements Interceptor{
Object beforeInvoke(Object object, String methodName, Object[] arguments){
null
}
boolean doInvoke(){ true }
Object afterInvoke(Object object, String methodName, Object[] arguments,
Object result){
if( object instanceof ArrayList && methodName == 'size' ){
result = (result as Integer) + 10 //add 10 to size of ArrayLists
}
result
}
}

```

```

}

def useInterceptor= { Class theClass, Class theInterceptor, Closure theCode->
def proxy= ProxyMetaClass.getInstance( theClass )
def interceptor= theInterceptor.newInstance()
proxy.interceptor= interceptor
proxy.use( theCode )
}

useInterceptor( ArrayList, MyInterceptor ){
assert ['a', 'b', 'c'].size() == 13
}

```

We can prevent methods being intercepted inside the interceptor by using special & notation:

```

class MyInterceptor implements Interceptor{
Object beforeInvoke( Object object, String methodName, Object[] arguments ){
null
}
boolean doInvoke(){ true }

Object afterInvoke( Object object, String methodName, Object[] arguments,
Object result ){
if( object instanceof ArrayList && methodName == 'size' ){
result = (result as Integer) + [1,2,3,4,5,6,7,8,9,10].&size()
// & before method name prevents re-interception of method
}
result
}
}

def useInterceptor= { Class theClass, Class theInterceptor, Closure theCode->
def proxy= ProxyMetaClass.getInstance( theClass )
def interceptor= theInterceptor.newInstance()
proxy.interceptor= interceptor
proxy.use( theCode )
}

useInterceptor( ArrayList, MyInterceptor ){
assert ['a', 'b', 'c'].size() == 13
}

```

Like categories, interceptors are only valid for a certain block in the current thread. We can also combine categories with interceptors in various ways, also only valid in the current thread:

```

class MyCategory{
static String categorize( String s ){ "categorized: $s" }
}

class StringInterceptor implements Interceptor{
Object beforeInvoke(Object object, String methodName, Object[] arguments){
if( object instanceof String )
use(MyCategory){
assert object.&categorize() == "categorized: $object"
}
null
}
boolean doInvoke(){ true }
Object afterInvoke(Object object, String methodName, Object[] arguments,
Object result){
if( object instanceof String )
result= "intercepted: $result"
result
}
}

def useInterceptor= { Class theClass, Class theInterceptor, Closure theCode->

```

```

def proxy= ProxyMetaClass.getInstance( theClass )
def interceptor= theInterceptor.newInstance()
proxy.interceptor= interceptor
proxy.use( theCode )
}

useInterceptor( String, StringInterceptor ){
assert new String('silver').toString() == 'intercepted: silver'

use(MyCategory){
assert new String('golden').categorize() ==
'intercepted: categorized: golden'
}

Thread.start{ //no interception in spawned thread...
use(MyCategory){
assert new String('bronze').categorize() == 'categorized: bronze'
}
}
}

```

Unintercepted Interceptors

The special & notation for bypassing interceptors handles simple code, but for more complex code we often need our own UninterceptedInterceptor:

```

abstract class UninterceptedInterceptor implements Interceptor{
def proxy= null //we need to know the proxy...

abstract Object doBefore( Object object, String methodName,
Object[] arguments )

public Object beforeInvoke( Object object, String methodName,
Object[] arguments ){

proxy.interceptor= null //...so we can turn off interception...
def result
try{
result= doBefore(object, methodName, arguments)
}catch(Exception e){
throw e
}finally{
proxy.interceptor= this //...and turn interception back on
}
result
}
abstract boolean doInvoke()

abstract Object doAfter( Object object, String methodName, Object[] arguments,
Object result )

public Object afterInvoke( Object object, String methodName,
Object[] arguments, Object result ){
proxy.interceptor= null //turn off interception
try{
result= doAfter(object, methodName, arguments, result)
}catch(Exception e){
throw e
}finally{
proxy.interceptor= this //turn interception back on
}
result
}
}

class MyInterceptor extends UninterceptedInterceptor{

```

```

Object doBefore( Object object, String methodName, Object[] arguments ){
null
}
boolean doInvoke(){ true }

Object doAfter( Object object, String methodName, Object[] arguments,
Object result ){
if( object instanceof ArrayList && methodName == 'size' ){
result = (result as Integer) + [1,2,3,4,5,6,7,8,9,10].size()
//call ArrayList size() method here without stack overflow
}
result
}
}

def useInterceptor= { Class theClass, Class theInterceptor, Closure theCode->
def proxy= ProxyMetaClass.getInstance( theClass )
def interceptor= theInterceptor.newInstance()
proxy.interceptor= interceptor
interceptor.proxy= proxy
//we must now store a proxy reference in the interceptor
proxy.use( theCode )
}

useInterceptor( ArrayList, MyInterceptor ){
assert ['a', 'b', 'c'].size() == 13
}

```

Intercepting many classes in one block

Often, we want to intercept more than one class in one block. This example is of an aliasing interceptor, which disables some English-language names for selected classes, and replaces them with Spanish-language names. We re-use the `UninterceptedInterceptor` class and `useInterceptor` utility from the previous example.

```

import org.codehaus.groovy.runtime.InvokerHelper

abstract class AliasInterceptor extends UninterceptedInterceptor{
protected aliases= [:]

private toReturn= null, toThrow= false, toInvoke= false

Object doBefore( Object object, String methodName, Object[] arguments ){
if( methodName in aliases.keySet() )
toReturn= InvokerHelper.invokeMethod( object, aliases[methodName],
arguments )
//use Spanish names instead
else if( methodName in aliases.values() ) toThrow= true
//disable the English names
else toInvoke= true //run other methods unchanged
null
}
Object doAfter( Object object, String methodName, Object[] arguments,
Object result ){
if( toReturn != null ){
result= toReturn
toReturn= null
}else if( toThrow ){
toThrow= false
throw new MissingMethodException( methodName, object.getClass(),
arguments )
}else toInvoke= false
result
}
boolean doInvoke(){ toInvoke }
}

```

```

}

class ArrayListAliasInterceptor extends AliasInterceptor{
  {aliases.putAll( [tamano:'size', todos:'each' ] )} //Spanish aliases
}

class HashMapAliasInterceptor extends AliasInterceptor{
  {aliases.putAll( [tamano:'size', todos:'each' ] )}
}

class LinkedHashMapAliasInterceptor extends AliasInterceptor{
  {aliases.putAll( [tamano:'size', todos:'each' ] )}
}

```

We call the code like so:

```

def useAliasing= { Closure c->
  useInterceptor(ArrayList, ArrayListAliasInterceptor){
  useInterceptor(HashMap, HashMapAliasInterceptor){
  useInterceptor(LinkedHashMap, LinkedHashMapAliasInterceptor){
  c()
  }
  }
  }
}

useAliasing{
def a= [1, 3, 5, 7, 9]
println 'size: '+ a.tamano()
//Spanish 'tamano' is an alias for the 'size' method
try{ println a.size(); assert 0 }
catch(e){ assert e instanceof MissingMethodException }
//English 'size' method disabled
a.todos{ println 'item: '+ it }
println ''

def b= [a:1, c:3, e:5, g:7]
println 'size: '+ b.tamano()
try{ println b.size(); assert 0 }
catch(e){ assert e instanceof MissingMethodException }
b.todos{ println 'item: '+ it }
println ''

def c= new LinkedHashMap( [e:5, g:7, i:9] )
println 'size: '+ c.tamano()
try{ println c.size(); assert 0 }
catch(e){ assert e instanceof MissingMethodException }
c.todos{ println 'item: '+ it }
}

```

We can put the cascadingly indented code into a list to make it neater by defining a utility category method on the List class.

```

class Extras{
  static closureInject(List self, Closure base){
  def z= []
  self.eachWithIndex{ it, i-> z<< {-> it( z[i+1] )} }
  z<< base
  z[0]()
  }
}

use(Extras){
  [ {c-> useInterceptor(ArrayList, ArrayListAliasInterceptor){ c() }},
  {c-> useInterceptor(HashMap, HashMapAliasInterceptor){ c() }},
  {c-> useInterceptor(LinkedHashMap, LinkedHashMapAliasInterceptor){ c() }},

```

```

].closureInject{
def a= [1, 3, 5, 7, 9],
b= [a:1, c:3, e:5, g:7],
c= new LinkedHashMap( [e:5, g:7, i:9] )

println 'size: '+ a.tamano()
try{ println a.size(); assert 0 }
catch(e){ assert e instanceof MissingMethodException }
a.todos{ println 'item: '+ it }
println ''

println 'size: '+ b.tamano()
try{ println b.size(); assert 0 }
catch(e){ assert e instanceof MissingMethodException }
b.todos{ println 'item: '+ it }
println ''

println 'size: '+ c.tamano()
try{ println c.size(); assert 0 }
catch(e){ assert e instanceof MissingMethodException }
c.todos{ println 'item: '+ it }
}
}

```

Our own ProxyMetaClass

We can define our own proxy meta-classes. One case for which we'd do so is to implement our own style of interceptors, here, an around-interceptor:

```

import org.codehaus.groovy.runtime.InvokerHelper

public class MyProxyMetaClass extends MetaClassImpl{
protected adaptee= null
def interceptor= null
MyProxyMetaClass(MetaClassRegistry registry, Class theClass,
MetaClass adaptee){
super(registry, theClass); this.adaptee = adaptee
}
static getInstance(Class theClass){
def metaRegistry = InvokerHelper.getInstance().getMetaRegistry()
new MyProxyMetaClass(metaRegistry, theClass,
metaRegistry.getMetaClass(theClass) )
}
void use(Closure closure){
registry.setMetaClass(theClass, this)
try{ closure.call() }
finally{ registry.setMetaClass(theClass, adaptee) }
}
void use(GroovyObject object, Closure closure){
object.setMetaClass(this)
try{ closure.call() }
finally{ object.setMetaClass(adaptee) }
}
Object invokeMethod(final Object object, final String methodName,
final Object[] arguments){
doCall(object, methodName, arguments,
{ adaptee.invokeMethod(object, methodName, arguments) } )
}
Object invokeStaticMethod(final Object object, final String methodName,
final Object[] arguments){
doCall(object, methodName, arguments,
{ adaptee.invokeStaticMethod(object, methodName, arguments) } )
}
Object invokeConstructor(final Object[] arguments){
doCall(theClass, "ctor", arguments,

```



```

{ adaptee.invokeConstructor(arguments) } )
}
Object invokeConstructorAt(final Class at, final Object[] arguments){
doCall(theClass, "ctor", arguments,
{ adaptee.invokeConstructorAt(at, arguments) } )
}
private Object doCall(Object object, String methodName, Object[] arguments,
Closure howToInvoke){
if (null == interceptor){ return howToInvoke.call() }
interceptor.aroundInvoke(object, methodName, arguments, howToInvoke)
}
}

interface AroundInterceptor{
Object aroundInvoke(Object object, String methodName, Object[] arguments,
Closure proceed)
}

```

We can then run our code:

```

class MyInterceptor implements AroundInterceptor{
Object aroundInvoke(Object object, String methodName, Object[] arguments,
Closure proceed){
println " BEFORE $object .$methodName $arguments"
def result= proceed()
println " AFTER $object .$methodName $arguments: $result"
result
}
}

class MyClass{
void sayHi(){ System.out.println 'hi' }
}

def interceptor= new MyInterceptor()
def proxy= MyProxyMetaClass.getInstance( MyClass )
proxy.use{
proxy.interceptor= interceptor
new MyClass().sayHi()
}

/*outputs:
BEFORE class MyClass .ctor {}
AFTER class MyClass .ctor {}: MyClass@1f5d386
BEFORE MyClass@1f5d386 .sayHi {}
hi
AFTER MyClass@1f5d386 .sayHi {}: null
*/

```

Using many Interceptors with our own ProxyMetaClass

We can only use one interceptor with the ProxyMetaClass supplied by Groovy, so we need to provide our own when attaching more than one interceptor to a class:

```

import org.codehaus.groovy.runtime.InvokerHelper

public class MultiInterceptorProxyMetaClass extends MetaClassImpl{
protected adaptee= null
def interceptors= [] //reference a list of interceptors, instead of just one

MultiInterceptorProxyMetaClass( MetaClassRegistry registry, Class theClass,
MetaClass adaptee ){
super(registry, theClass)
this.adaptee = adaptee
if( null == adaptee )
throw new IllegalArgumentException( "adaptee must not be null" )
}
}

```

```

}
static getInstance(Class theClass){
def metaRegistry= InvokerHelper.getInstance().getMetaRegistry()
new MultiInterceptorProxyMetaClass( metaRegistry, theClass,
metaRegistry.getMetaClass(theClass) )
}
void use(Closure closure){
registry.setMetaClass(theClass, this)
registry.getMetaClass(theClass).initialize()
try{ closure.call() }
finally{ registry.setMetaClass(theClass, adaptee) }
}
void use(GroovyObject object, Closure closure){
object.setMetaClass(this)
try{ closure.call() }
finally{ object.setMetaClass(adaptee) }
}
Object invokeMethod( final Object object, final String methodName,
final Object[] arguments ){
doCall(object, methodName, arguments,
{ adaptee.invokeMethod(object, methodName, arguments) } )
}
Object invokeStaticMethod( final Object object, final String methodName,
final Object[] arguments ){
doCall(object, methodName, arguments,
{ adaptee.invokeStaticMethod(object, methodName, arguments) } )
}
Object invokeConstructor(final Object[] arguments){
doCall(theClass, "ctor", arguments,
{ adaptee.invokeConstructor(arguments) } )
}
public Object invokeConstructorAt(final Class at, final Object[] arguments){
doCall(theClass, "ctor", arguments,
{ adaptee.invokeConstructorAt(at, arguments) } )
}
private Object doCall( Object object, String methodName, Object[] arguments,
Closure howToInvoke ){
if( interceptors == [] ){ return howToInvoke.call() }
def result
interceptors.each{ //different logic to cater for all the interceptors

result= it.beforeInvoke(object, methodName, arguments)
if( it.doInvoke() ){ result= howToInvoke.call() }
it.afterInvoke(object, methodName, arguments, result)
}
result
}
}
}

```

Using a MultiInterceptorProxyMetaClass for the Observer pattern

A common design pattern is the Observer pattern. Using interceptors, we can abstract the observation code into its own class, the ObserverProtocol, which can be used by subclasses. It enables us to add and remove observing objects for an observed object. We use method interception to decouple the observing and observed objects from the observation relationship itself.

```

abstract class ObserverProtocol implements Interceptor{
private perSubjectObservers

protected getObservers( subject ){
if( perSubjectObservers == null ) perSubjectObservers= [:]
def observers= perSubjectObservers[ subject ]
if( observers == null ){
observers= []
perSubjectObservers[ subject ]= observers
}
}
}

```

```

}
observers
}

public void addObserver( subject, observer ){
getObservers(subject) << observer
}
public void removeObserver( subject, observer ){
getObservers(subject).remove(observer)
}

abstract Object beforeInvoke( Object object, String methodName,
Object[] arguments )

abstract boolean doInvoke()

abstract Object afterInvoke( Object object, String methodName,
Object[] arguments, Object result )
}

```

We can extend this ObserverProtocol with domain-specific observers. The example is a Groovy rewrite of one first implemented in AspectJ by Jan Hannemann and Gregor Kiczales.

```

public class Screen{ //class to be observed
def name
public Screen( String s ){
this.name= s
}
public void display( String s ){
println(this.name + ": " + s)
}
}

public class Point{ //class to be observed
def x, y, color
public Point( int x, int y, Color color ){
this.x=x
this.y=y
this.color=color
}
}

class ColorObserver extends ObserverProtocol{
Object beforeInvoke( Object object, String methodName, Object[] arguments ){
null
}
boolean doInvoke(){ true }
Object afterInvoke( Object object, String methodName, Object[] arguments,
Object result ){
if( object instanceof Point && methodName == 'setColor' ){
getObservers(object).each{
it.display("Screen updated (point subject changed color).")
}
}
}
result
}
}

class CoordinateObserver extends ObserverProtocol{
Object beforeInvoke( Object object, String methodName, Object[] arguments ){
null
}
boolean doInvoke(){ true }
Object afterInvoke( Object object, String methodName, Object[] arguments,
Object result ){
if( object instanceof Point && ['setX', 'setY'].contains(methodName) ){

```

```

getObservers(object).each{
it.display("Screen updated (point subject changed coordinates).")
}
}
result
}
}

class ScreenObserver extends ObserverProtocol{
Object beforeInvoke( Object object, String methodName, Object[] arguments ){
null
}
boolean doInvoke(){ true }
Object afterInvoke( Object object, String methodName, Object[] arguments,
Object result ){
if( object instanceof Screen && methodName == 'display' ){
getObservers(object).each{
it.display("Screen updated (screen subject changed message).")
}
}
}
result
}
}

```

Now we run the program. It first creates five Screen objects (s1, s2, s3, s4, and s5) and one point object, then sets up some observing relationships (namely, s1 and s2 will observe color changes to the point, s3 and s4 will observe coordinate changes to the point, and s5 will observe s2's and s4's display method), and finally, make changes to the point, first, the color, then its x-coordinate. The color change triggers s1 and s2 to each print an appropriate message. s2's message triggers its observer s5 to print a message. The coordinate change triggers s3 and s4 to print a message. s4's message also triggers the observer s5.

```

import java.awt.Color

def colorObserver= new ColorObserver()
def coordinateObserver= new CoordinateObserver()
def screenObserver= new ScreenObserver()

def pointProxy= MultiInterceptorProxyMetaClass.getInstance( Point )
pointProxy.interceptors << colorObserver << coordinateObserver
//multi-interception used here
pointProxy.use{

def screenProxy= MultiInterceptorProxyMetaClass.getInstance( Screen )
screenProxy.interceptors << screenObserver
screenProxy.use{

println("Creating Screen s1,s2,s3,s4,s5 and Point p")
def s1= new Screen('s1'),
s2= new Screen('s2'),
s3= new Screen('s3'),
s4= new Screen('s4'),
s5= new Screen('s5')
def p= new Point(5, 5, Color.blue)

println("Creating observing relationships:")
println(" - s1 and s2 observe color changes to p")
println(" - s3 and s4 observe coordinate changes to p")
println(" - s5 observes s2's and s4's display() method")

colorObserver.addObserver(p, s1)
colorObserver.addObserver(p, s2)
coordinateObserver.addObserver(p, s3)
coordinateObserver.addObserver(p, s4)
screenObserver.addObserver(s2, s5)
screenObserver.addObserver(s4, s5)

```

```

println("Changing p's color:")
p.setColor(Color.red)

println("Changing p's x-coordinate:")
p.setX(4)

println("done.")
}
}

/*output:
Creating Screen s1,s2,s3,s4,s5 and Point p
Creating observing relationships:
- s1 and s2 observe color changes to p
- s3 and s4 observe coordinate changes to p
- s5 observes s2's and s4's display() method
Changing p's color:
s1: Screen updated (point subject changed color).
s2: Screen updated (point subject changed color).
s5: Screen updated (screen subject changed message).
Changing p's x-coordinate:
s3: Screen updated (point subject changed coordinates).
s4: Screen updated (point subject changed coordinates).
s5: Screen updated (screen subject changed message).
done.
*/

```

Using a MultiInterceptorProxyMetaClass and UninterceptedFriendlyInterceptor for the Decorator pattern

We can use more than one unintercepted interceptor with a proxy meta-class. A good example where this is necessary is the Decorator pattern. We re-use the MultiInterceptorProxyMetaClass from previous examples, but must write a special unintercepted interceptor, which we call an UninterceptedFriendlyInterceptor, that can be used as one of many with the MultiInterceptorProxyMetaClass.

```

abstract class UninterceptedFriendlyInterceptor implements Interceptor{
def proxy= null

abstract Object doBefore( Object object, String methodName,
Object[] arguments )

public Object beforeInvoke(Object object, String methodName,
Object[] arguments){
def theInterceptors= proxy.interceptors
proxy.interceptors= null
def result
try{
result= doBefore(object, methodName, arguments)
}catch(Exception e){
throw e
}finally{
proxy.interceptors= theInterceptors
}
result
}
abstract boolean doInvoke()

abstract Object doAfter( Object object, String methodName,
Object[] arguments, Object result )

public Object afterInvoke(Object object, String methodName,
Object[] arguments, Object result){
def theInterceptors= proxy.interceptors
proxy.interceptors= null

```

```

try{
result= doAfter(object, methodName, arguments, result)
}catch(Exception e){
throw e
}finally{
proxy.interceptors= theInterceptors
}
result
}
}

```

For our example Decorator pattern, we'll code an OutputStreamWriter that prints extra if necessary. We use decorators extended from the UninterceptableFriendlyInterceptor. Firstly, a NewlineDecorator that uses a line-width policy to perhaps place the output on a new line. And second, a very simple WhitespaceDecorator that ensures there's some whitespace between any two consecutive items output. Each has only very simple logic for this example.

```

abstract class PrintDecorator extends UninterceptedFriendlyInterceptor{
abstract Object doBefore( Object object, String methodName,
Object[] arguments )

abstract Object doAfter( Object object, String methodName, Object[] arguments,
Object result )

//only execute the intercepted method if it's the last class in the chain of
//decorators around the method...
boolean doInvoke(){ proxy.interceptors[-1] == this }
}

class NewlineDecorator extends PrintDecorator{
int lineSizeSoFar= 0

Object doBefore( Object object, String methodName, Object[] arguments ){
if( methodName == 'leftShift' && arguments[0] instanceof String ){
if( lineSizeSoFar + arguments[0].size() > 30){
arguments[0]= '\r\n' + arguments[0]
lineSizeSoFar= 0
}else{
lineSizeSoFar += arguments[0].size()
}
}
}

Object doAfter( Object object, String methodName, Object[] arguments,
Object result ){
result
}
}

class WhitespaceDecorator extends PrintDecorator{
def prevOutput= ' '

Object doBefore( Object object, String methodName, Object[] arguments ){
if( methodName == 'leftShift' && arguments[0] instanceof String ){
if( prevOutput[-1] != ' ' && prevOutput[-1] != '\n' ){
arguments[0] = ' ' + arguments[0]
}
}
}

Object doAfter( Object object, String methodName, Object[] arguments,
Object result ){
if( methodName == 'leftShift' && arguments[0] instanceof String ){
prevOutput= arguments[0]
}
}
result
}

```

```
}  
}
```

After the classes, interceptors, and code block are matched up, the printing logic and the `OutputStreamWriter` are both unaware that the output is being decorated. Each decorator will perhaps modify the output, then pass it along to the next decorator to do the same. The distinct items of output sent to the `OutputStreamWriter` are separated by spaces, whether or not a space was in the output string in the program, and the output fits within a certain width.

```
oswProxy= MultiInterceptorProxyMetaClass.getInstance( OutputStreamWriter )  
[ new NewlineDecorator(),  
new WhitespaceDecorator(), //the order of these decorators is important  
].each{  
it.proxy= oswProxy  
oswProxy.interceptors << it  
}  
oswProxy.use{  
def wtr= new OutputStreamWriter(  
new FileOutputStream( new File('TheOutput.txt') ) )  
wtr<< "Singing in the Rain" <<  
"hello " <<  
"climate  " <<  
"hotrod" <<  
"far out and spacy" <<  
'Clementine, darling'  
wtr.close()  
}  
  
/*output file:  
Singing in the Rain hello  
climate  hotrod far out and spacy  
Clementine, darling  
*/
```

JN3525-MetaClasses

This page last changed on Aug 27, 2007 by [gavingrover](#).

Groovy gives us a wide variety of choices for meta-programming. We've looked at Categories and Interceptors, which change the behavior of objects within a selected block and current thread only, in other tutorials. In this tutorial, we'll learn about more ways of meta-programming in Groovy.

Intercepting Method Calls and Property Accesses

We can add a special method called 'invokeMethod' to a class definition that executes calls to undefined methods:

```
class MyClass{
def hello(){ 'invoked hello directly' }
def invokeMethod(String name, Object args){
return "unknown method $name(${args.join(', ')})"
}
}
def mine= new MyClass()
assert mine.hello() == 'invoked hello directly'
assert mine.foo("Mark", 19) == 'unknown method foo(Mark, 19)'
```

If our class implements GroovyInterceptable, invokeMethod is called for all method invocations whether they exist or not:

```
class MyClass implements GroovyInterceptable{
def hello(){ 'invoked hello() directly' }
def invokeMethod(String name, Object args){
"invoked method $name(${args.join(', ')})"
}
}
def mine= new MyClass()
assert mine.hello() == 'invoked method hello()'
assert mine.foo('Mark', 19) == 'invoked method foo(Mark, 19)'
```

```
assert mine.&hello() == 'invoked hello() directly'
//we can still invoke a method directly using .& syntax
```

We can get and set properties using special method names:

```
class MyClass{
def greeting= 'accessed greeting directly'
Object getProperty(String property){
"read from property $property"
}
void setProperty(String property, Object newValue){
throw new Exception("wrote to property $property")
}
}
def mine= new MyClass()
assert mine.greeting == 'read from property greeting'
try{
mine.greeting= 'hi'
}catch(e){ assert e.message == 'wrote to property greeting' }
```

```
assert mine.@greeting == 'accessed greeting directly'
//we can access a property directly using .@ syntax
```

When there's a field of some name, referring to that name still considers it to be a property unless the syntax .@ is used:

```
class MyClass{
public greeting= 'accessed field greeting (directly)' //field, not property
Object getProperty(String property){
"read from property $property"
}
}
```



```

}
def mine= new MyClass()
assert mine.greeting == 'read from property greeting'
assert mine.@greeting == 'accessed field greeting (directly)'

```

We can call methods and access properties directly, both statically and dynamically, from within the class using various syntaxes:

```

class MyClass implements GroovyInterceptable{
def greeting= 'accessed greeting'
def id= 'White: '

Object getProperty(String property){
try{
return this.@id + //access field directly
'indirectly ' +
this.@"$property" //access field directly and dynamically
}catch(e){
return "no such property $property"
}
}

def hello(Object[] args){ "invoked hello with (${args.join(', ')}" }
def id(){ 'Green: ' }

def invokeMethod(String name, Object args){
try{
return this.&id() + //call method directly
'indirectly ' +
this.&"$name"(args) //call method directly and dynamically
}catch(e){
return "no such method $name"
}
}

def mine= new MyClass()
assert mine.greeting == 'White: indirectly accessed greeting'
assert mine.farewell == 'no such property farewell'

assert mine.hello(1, 'b', 3) == 'Green: indirectly invoked hello with (1, b, 3)'
assert mine.foo('Mark', 19) == 'no such method foo'

```

If we add such 'invokeMethod', 'getProperty', or 'setProperty' methods to an object using Expando or Category syntax, they act just like normal methods. Not many supplied classes have 'invokeMethod' and such defined. For such cases, we need to use MetaClasses.

MetaClasses

We've seen how classes behave with the default MetaClass:

```

class A{
def bark(){ 'A: invoked bark()' }
def invokeMethod(String name, Object args){
"A: missing $name(${args.join(', ')}"
}
}
def a= new A()
assert a.bark() == 'A: invoked bark()'
assert a.bleet() == 'A: missing bleet()'

```

We can create our own MetaClass which wraps around the existing one. DelegatingMetaClass provides the infrastructure for this, so we only need extend it with our own logic. We can do so on an instance-by-instance basis:

```

public class MyMetaClass extends DelegatingMetaClass{

```

```

MyMetaClass(Class theClass){
  super(theClass)
}
Object invokeMethod(Object object, String methodName, Object[] arguments){
  "MyMetaClass: ${super.invokeMethod(object, methodName, arguments)}"
}
}

public class MyOtherMetaClass extends DelegatingMetaClass{
  MyOtherMetaClass(Class theClass){
    super(theClass)
  }
  Object invokeMethod(Object object, String methodName, Object[] arguments){
    "MyOtherMetaClass: ${super.invokeMethod(object, methodName, arguments)}"
  }
}

class A{
  def bark(){ 'A: invoked bark()' }
  def invokeMethod(String name, Object args){
    "A: missing $name(${args.join(', ')})"
  }
}

def amc= new MyMetaClass(A)
amc.initialize()
def a= new A()
a.metaClass= amc
//using metaClass property on an instance affects only that instance...

def amc2= new MyOtherMetaClass(A)
amc2.initialize()
def a2= new A()
a2.metaClass= amc2

assert a.bark() == 'MyMetaClass: A: invoked bark()'
assert a2.bark() == 'MyOtherMetaClass: A: invoked bark()'

Thread.start{                                     //...even in a new thread
  assert a.bark() == 'MyMetaClass: A: invoked bark()'
  assert a2.bark() == 'MyOtherMetaClass: A: invoked bark()'
}

assert new A().bark() == 'A: invoked bark()'
//new instances don't have new MetaClass

assert a.bleet() == 'A: missing bleet()'
//MetaClass invokeMethod() NOT called here

```

Or we can do so on a class-wide basis:

```

public class MyMetaClass extends DelegatingMetaClass{
  MyMetaClass(Class theClass){
    super(theClass)
  }
  Object invokeMethod(Object object, String methodName, Object[] arguments){
    "MyMetaClass: ${super.invokeMethod(object, methodName, arguments)}"
  }
}

class A{
  def bark(){ 'A: invoked bark()' }
  def invokeMethod(String name, Object args){
    "A: missing $name(${args.join(', ')})"
  }
}

```

```

def amc= new MyMetaClass(A)
amc.initialize()

def a= new A()

import org.codehaus.groovy.runtime.InvokerHelper
InvokerHelper.instance.metaRegistry.setMetaClass(A, amc)
//all newly-created instances of A after this call will be affected

assert a.bark() == 'A: invoked bark()' //created before so old MetaClass used
assert a.bleet() == 'A: missing bleet()'

assert new A().bark() == 'MyMetaClass: A: invoked bark()' //new MetaClass used
Thread.start{
assert a.bark() == 'A: invoked bark()' //old MetaClass used
assert new A().bark() == 'MyMetaClass: A: invoked bark()' //new MetaClass used
}

```

Classes we define ourselves return a MetaClass when accessing the metaClass property, but many Groovy-supplied classes don't. There's only one instance of a MetaClass in such cases:

```

class A{}
assert new A().metaClass.class == MetaClassImpl
assert new ArrayList().metaClass.class == ArrayList //class itself returned

```

When we use Groovy-supplied classes without their own MetaClass, both already-created and newly-created classes are affected by changes to the MetaClass:

```

public class MyMetaClass extends DelegatingMetaClass{
MyMetaClass(Class theClass){
super(theClass)
}
Object invokeMethod(Object object, String methodName, Object[] arguments){
"MyMetaClass: ${super.invokeMethod(object, methodName, arguments)}"
}
}

def amc= new MyMetaClass(ArrayList)
amc.initialize()

def list1= [1, 2, 3]

import org.codehaus.groovy.runtime.InvokerHelper
InvokerHelper.instance.metaRegistry.setMetaClass(ArrayList, amc)
//all instances of ArrayList will be affected, even already created ones

assert list1.join(',') == 'MyMetaClass: 1,2,3'
//new MetaClass used with already created ArrayList

def list2= [4, 5, 6]
assert list2.join(',') == 'MyMetaClass: 4,5,6'
//new MetaClass used with newly created ArrayList

//even in new Thread...
Thread.start{
assert list1.join(',') == 'MyMetaClass: 1,2,3' //new MetaClass used
assert list2.join(',') == 'MyMetaClass: 4,5,6' //new MetaClass used
assert [7, 8, 9].join(',') == 'MyMetaClass: 7,8,9' //new MetaClass used
}

```

Other methods besides invokeMethod are available on the MetaClass:

```

Object invokeStaticMethod(Object object, String methodName, Object[] arguments)
Object invokeConstructor(Object[] arguments)
Object getProperty(Object object, String property)
void setProperty(Object object, String property, Object newValue)

```

```

Object getAttribute(Object object, String attribute)
void setAttribute(Object object, String attribute, Object newValue)
Class getTheClass()

```

For example, making the constructor return an instance of something other than what we called the constructor on:

```

public class MyMetaClass extends DelegatingMetaClass{
MyMetaClass(Class theClass){
super(theClass)
}
Object invokeConstructor(Object[] arguments){
[]
}
}
class A{}

def amc= new MyMetaClass(A)
amc.initialize()
import org.codehaus.groovy.runtime.InvokerHelper
InvokerHelper.instance.metaRegistry.setMetaClass(A, amc)

def a= new A()
assert a.class == ArrayList
assert ( a << 1 << 2 << 3 ).size() == 3

```

ExpandoMetaClass

There's some easy-to-use facilities available through the MetaClass, known as ExpandoMetaClass, to which we can add properties and methods easily:

```

class A{
String text
}
def a1= new A(text: 'aBCdefG')
assert a1.metaClass.class == MetaClassImpl //usual MetaClass type

A.metaClass.inSameCase= {-> text.toUpperCase()}
//triggers conversion of MetaClass of A to ExpandoMetaClass
//then adds new instance method 'inUpperCase' to class

def a2= new A(text: 'hiJKLmnOp')
assert a2.metaClass.getClass() == ExpandoMetaClass
//MetaClass of A changed for instances created after conversion trigger only
assert a2.inSameCase() == 'HIJKLMNOP'

assert a1.metaClass.class == MetaClassImpl //still usual MetaClass type
try{ println a1.inSameCase(); assert false }
catch(e){ assert e in MissingMethodException } //new method not available

A.metaClass.inLowerCase= {-> text.toLowerCase()}
assert a2.inLowerCase() == 'hijklmnop'

//we can replace the method definition with another
A.metaClass.inSameCase= {-> text.toLowerCase()}
assert a2.inSameCase() == 'hijklmnop'

A.metaClass.inSameCase= null //remove method
try{ println a1.inSameCase(); assert false }
catch(e){ assert e in MissingMethodException } //method no longer available

//we can add static methods...
A.metaClass.'static'.inSameCase= { it.toLowerCase()}
assert A.inSameCase('qRStuVwXyz') == 'qrstuvwxyz'

```

We can also add properties and constructors:

```

class A{}

//we can let ExpandoMetaClass manage the properties...
A.metaClass.character = 'Cat in the Hat' //add property 'character'

def a1= new A()
assert a1.character == 'Cat in the Hat'

//...or we can manage the properties ourselves...
def ourProperties = Collections.synchronizedMap([:])
//see tutorial on Multi-Threading to learn about synchronized objects
A.metaClass.setType= { String value ->
ourProperties[ "${delegate}Type" ] = value
}
A.metaClass.getType= {->
ourProperties[ "${delegate}Type" ]
}
a1.type= 'Hatted Cat'
assert a1.type == 'Hatted Cat'

//we can add our own constructors...
def a2= new A()
A.metaClass.constructor= {-> new A() }
try{
a2= new A() //be careful when overriding default or existing constructors
assert false
}catch(Error e){ assert e in StackOverflowError }

A.metaClass.constructor= {-> new A() }
try{
A.metaClass.constructor << {-> new A() }
// << notation doesn't allow overriding
assert false
}catch(e){ assert e in GroovyRuntimeException }

A.metaClass.constructor= { String s-> new A(character: s) }
a2 = new A("Thing One")

//We can quote method and property names...
A.metaClass.'changeCharacterToThingTwo'=
{-> delegate.character = 'Thing Two' }
a2.character= 'Cat in the Hat'
a2.changeCharacterToThingTwo()
assert a2.character == 'Thing Two'

//...which is handy for dynamically constructing method/property names...
['Hatted Cat', 'Thing', 'Boy', 'Girl', 'Mother'].each{p->
A.metaClass."changeTypeTo${p}"= {-> delegate.type= p}
}
a2.changeTypeToBoy()
assert a2.type == 'Boy'

a2.'changeTypeToHatted Cat'()
assert a2.type == 'Hatted Cat'

```

We can also add methods for supplied Groovy classes, ones we don't define ourselves:

```

ExpandoMetaClass.enableGlobally()
//call 'enableGlobally' method before adding to supplied class
List.metaClass.sizeDoubled = {-> delegate.size() * 2 }
//add method to an interface
def list = [] << 1 << 2
assert list.sizeDoubled() == 4

```

We can override MetaClass class methods such as 'invokeMethod' and 'getProperty' using ExpandoMetaClass's easy syntax:

```

class Bird{
def name= 'Tweety'
def twirp(){ 'i taught i saw a puddy cat' }
}
Bird.metaClass.invokeMethod= {name, args->
def metaMethod= Bird.metaClass.getMetaMethod(name, args)
//'getMetaMethod' gets method, which may be an added or an existing one
metaMethod? metaMethod.invoke(delegate,args): 'no such method'
}
def a= new Bird()
assert a.twirp() == 'i taught i saw a puddy cat'
assert a.bleet() == 'no such method'

Bird.metaClass.getProperty= {name->
def metaProperty= Bird.metaClass.getMetaProperty(name)
//'getMetaProperty' gets property, which may be an added or an existing one
metaProperty? metaProperty.getProperty(delegate): 'no such property'
}
def b= new Bird()
assert b.name == 'Tweety'
assert b.filling == 'no such property'

```

JN3535-Reflection

This page last changed on Aug 30, 2007 by [gavingrover](#).

We can examine classes in Groovy to find out information in the form of strings.

Examining Classes

To find out a class's name and superclasses:

```
class A{}
assert A.name == 'A'
assert new A().class.name == 'A'
assert A.class.name == 'A' //'class' is optionally used here

class B extends A{}
assert B.name == 'B'

class C extends B{}
def hierarchy= []
def s = C
while(s != null){ hierarchy << s.name; s= s.superclass }
assert hierarchy == [ 'C', 'B', 'A', 'java.lang.Object' ]
```

To examine the interfaces:

```
interface A1{}
interface A2{}
class A implements A1, A2{}
def interfacesA = [] as Set //use a set because interfaces are unordered
A.interfaces.each{ interfacesA << it.name }
assert interfacesA == [ 'A1', 'A2', 'groovy.lang.GroovyObject' ] as Set

interface B1{}
class B extends A implements B1{}
def interfacesB = [] as Set
B.interfaces.each{ interfacesB << it.name }
assert interfacesB == [ 'B1' ] as Set
//only immediately implemented interfaces are reported
```

We can check if a class is a class or an interface:

```
assert Observer.isInterface()
assert ! Observable.isInterface()
```

We can examine public fields and their types:

```
class A{
def adyn //if no modifier, field is private
String astr
public apdyn
public String apstr
protected aqdyn
}
interface B1{}
interface B2{}
class B extends A implements B1, B2{
def bdyn
int bint
public bpdyn
public int bpint
protected bqdyn
}
def dets = [] as Set
B.fields.each{ //public fields only
dets << [ it.name, it.type.name ] //name of field and name of type
}
```

```

assert dets == [
[ 'apstr', 'java.lang.String' ],
[ 'apdyn', 'java.lang.Object' ],
[ 'bpint', 'int' ],
[ 'bpdyn', 'java.lang.Object' ],
[ '__timeStamp', 'java.lang.Long' ], //added by Groovy
] as Set

```

We can look at a certain field of a class:

```

assert Math.fields.name as Set == [ 'E', 'PI' ] as Set
assert Math.class.getField('PI').toString() ==
'public static final double java.lang.Math.PI'
assert Math.class.getField('PI').getDouble() == 3.141592653589793
//we must know the type of the value

```

We can also look at the constructors and methods of a class:

```

assert HashMap.constructors.collect{ it.parameterTypes.name } as Set ==
[ ['int'], [], ['java.util.Map'], ['int', 'float'] ] as Set
GroovyObject.methods.each{ println it }
//to print full details of each method of a class
assert GroovyObject.methods.name as Set ==
['invokeMethod', 'getMetaClass', 'setMetaClass',
'setProperty', 'getProperty'] as Set
assert GroovyObject.getMethod('getMetaClass').toString() ==
'public abstract groovy.lang.MetaClass groovy.lang.GroovyObject.getMetaClass()'

```

Some code to find out all the getters for a class:

```

getters= {
it.methods.name.findAll{ it =~ /^get[A-Z]/ }.
collect{ it[3].toLowerCase()+it[4..-1] }.join(', ')
}
assert getters( GroovyObject ) == 'metaClass, property'

```

To see all nested classes for a particular class (eg, of Character):

```

assert Character.classes.name as Set ==
[ 'java.lang.Character$Subset', 'java.lang.Character$UnicodeBlock' ] as Set

```

To query a particular nested class (eg, Character.UnicodeBlock):

```

Character.UnicodeBlock.fields.name.each{ println it }
//to list all public constants

```

Reflecting the Reflection classes themselves

We can use reflection on the reflection classes themselves. For example:

```

assert Class.methods[0].class == java.lang.reflect.Method
//find the class of any method of any class...
java.lang.reflect.Method.methods.each{ println it.name }
//...then find its method names...

//...to help us build a custom-formatted listing of method details
HashMap.class.methods.each{
println ""`${it.name( ${it.parameterTypes.name.join(', ')} ) returns \
${it.returnType.name} ${it.exceptionTypes.size()>0?'throws ':''}\
${it.exceptionTypes.name.join(', ')}""`
}

```

We can look at the modifiers of methods and classes:

```

import java.lang.reflect.Modifier
Modifier.methods.name.sort{}.each{ println it }
//use reflection on the reflection classes themselves...

```



```
//...to help us build a custom-formatted listing of modifier details
[ (ArrayList.getMethod( 'remove', [Object] as Class[] ))):
[ 'public' ] as Set,
(Collections.getMethod( 'synchronizedList', [List] as Class[] )):
[ 'public', 'static' ] as Set,
(Math): [ 'public', 'final' ] as Set,
(ClassLoader): [ 'public', 'abstract' ] as Set,
].each{ key, val->
def m= key.modifiers
def mods= [
({Modifier.isPublic(it)}):      'public',
({Modifier.isProtected(it)}):   'protected',
({Modifier.isPrivate(it)}):     'private',
({Modifier.isInterface(it)}):   'interface',
({Modifier.isAbstract(it)}):    'abstract',
({Modifier.isFinal(it)}):       'final',
({Modifier.isStatic(it)}):      'static',
({Modifier.isVolatile(it)}):    'volatile',
({Modifier.isNative(it)}):      'native',
({Modifier.isStrict(it)}):      'strict',
({Modifier.isSynchronized(it)}): 'synchronized',
({Modifier.isTransient(it)}):   'transient',
].collect{ k, v-> k(m)? v: null } as Set
mods.removeAll( [null] )
assert mods == val
}
}
```

Manipulating Objects

When a class is unknown at compile time (eg, we only have a string representation of a class name), we can use reflection to create objects:

```
assert Class.forName("java.util.HashMap").newInstance() == [:]

def constructor = Class.forName("java.util.HashMap").
getConstructor( [ int, float ] as Class[] )
assert constructor.toString() == 'public java.util.HashMap(int,float)'
assert constructor.newInstance( 12, 34.5f ) == [:]
```

We can examine and change public fields for a class referring using a String for the name:

```
class A{
public value1
protected value2
A( int v ){ value1= v; value2 = v }
}
def a= new A( 100 )
assert A.getField( 'value1' ).get( a ) == 100 //public fields only

try{ A.getField( 'value2' ).get( a ); assert false }
catch(Exception e){ assert e instanceof NoSuchFieldException }

A.getField( 'value1' ).set( a, 350 )
assert a.value1 == 350
```

And we can call methods using a string for the name:

```
assert String.getMethod( 'concat', [ String ] as Class[] ).
invoke( 'Hello, ', [ 'world!' ] as Object[] ) == 'Hello, world!'
```

Working with Arrays

We can examine and manipulate arrays. To enquire the public array fields of a class:

```
class A{
```

```

public boolean alive
public int[] codes
public Date[] dates
protected boolean[] states
}
//find all public array fields
def pubFields= new A().class.fields.findAll{ it.type.isArray() }.
collect{ [it.name, it.type.name] }
assert pubFields == [
[ 'codes', '[I' ], //'[I' means array of int
[ 'dates', '[Ljava.util.Date;' ], //means array of object java.util.Date
]

```

To enquire the component type/s of an array:

```

[
(int[]): [ '[I', 'int' ],
(Date[]): [ '[Ljava.util.Date;', 'java.util.Date' ],
(new Date[6].class): [ '[Ljava.util.Date;', 'java.util.Date' ],
//instantiated class
(String[][]): [ '[Ljava.lang.String;', '[Ljava.lang.String;' ],
].each{
k, v -> assert [ k.name, k.componentType.name ] == v
}

```

We can create and copy arrays when their component type and size is unknown at compile time:

```

import java.lang.reflect.Array
def a1 = [55, 66] as int[]

//component type and size unknown at compile time...
def a2 = Array.newInstance( a1.class.componentType, a1.size() * 2 )
assert a2.class.componentType == int
assert a2.size() == 4
System.arraycopy( a1, 0, a2, 0, a1.size() )
assert a2 as List == [55, 66, 0, 0] as List

```

We can create multi-dimensional arrays in a similar way, where component type and array sizes can be unknown at compile time:

```

import java.lang.reflect.Array

//assertion checking code...
assert1D= {x,y->
assert x.size() == y.size()
for( int i: x.size() - 1 ) assert x[ i ] == y[ i ]
}
assert2D= {x,y->
assert x.size() == y.size()
for( int i: x.size() - 1 ){
assert x[ i ].size() == y[ i ].size()
for( int j: x[ i ].size() - 1 ) assert x[ i ][ j ] == y[ i ][ j ]
}
}

//each is a 1-D int array with 3 elts
def a0= new char[ 3 ]
def a1= Array.newInstance( char, 3 )
def a2= Array.newInstance( char, [ 3 ] as int[] )
assert1D( a0, a1 )
assert1D( a0, a2 )

//both are a 2-D 3x4 array of String elts
def b0= new String[3][4]
def b1= Array.newInstance( String, [ 3, 4 ] as int[] )
assert2D( b0, b1 )

//both are a 2-D array of 6 char arrays, with undefined tail dimension

```

```
def c0 = new char[6][ ]
def c1 = Array.newInstance( char[], [ 6 ] as int[] )
assert1D( c0, c1 )
```

We can use `set()` and `get()` to copy the contents of one array index to another:

```
import java.lang.reflect.Array
def a= [ 12, 78 ] as int[], b= new int[ 4 ]
Array.set( b, 0, Array.get( a, 0 ) )
assert b[ 0 ] == 12
```

This tutorial is loosely based on Sun's tutorial on Java Reflection, but using Groovy code instead.

Groovy for the Office

This page last changed on Nov 20, 2007 by [jasonsmith](#).

We all know Groovy as our super hero for enhancing Java with all the latest programming features. When not in super hero mode, Groovy is just as happy as a mild-mannered office worker. Here are some links to get you started if you need some help around the office:

- The [Scriptom Module](#) can be used to script Word, Excel, PowerPoint etc. on Windows.
- [OpenXML4J](#) is a Java library dedicated to the creation and manipulation of Office Open XML (ECMA-376) and OPC based documents (for example Office 2007 Word, Excel and PowerPoint documents). OpenXML4J provides you a way to create and manipulate Open XML documents for a bunch of scenarios without using any office suite.
- [Apache POI](#) consists of APIs for manipulating various file formats based upon Microsoft's OLE 2 Compound Document format using pure Java. In short, you can read and write MS Excel, Word, PowerPoint files (97-2003 with varying levels of support) using Java.
- [WebTest's Excel Steps](#) lets you test Excel content. The examples are in XML (Ant build format) but you can use Groovy with AntBuilder too.
- [Using Java to Crack Office 2007](#) is an article about using Java to read and write any Office 2007 document. You can use Groovy's XML features to make these examples even simpler.
- Ted Neward's [Best of Both Worlds](#) whitepaper describes how to make the Java and Microsoft/.Net worlds interoperate. Most of those examples apply equally well to Groovy and .Net.
- [JExcel](#) is a commercial offering that provides an effective way to integrate Microsoft Excel into Swing applications.
- [Groovy For OpenOffice](#) is an OpenOffice Extension that adds support for scripting OpenOffice Macros in Groovy. Related Articles:
 - [Record macros in OpenOffice with Groovy](#)
 - [Groovy as a business user language?](#)

Groovy Quick Start Project

This page last changed on Aug 29, 2007 by corey_s@qwest.net.

Groovy Starter is meant to help developers new to groovy to get started by providing a way to have a groovy project up and running with a minimum effort. GroovyQuickStart provides a default project layout and a reusable gant script that knows how to compile, test and package your project out of the box. for more information visit

http://softwarecraft.org/blog/?page_id=11;

Additional info for unix/linux users

An example 'run' script to test the distribution: [run](#)

Use that instead of the 'run.bat' that comes packaged in the groovyquickstart.zip .

Quick Start

This page last changed on Dec 10, 2007 by sumit@hotmail.com.

Before beginning...

Before playing with the examples you'll find below, you should first look at:

- [Installing Groovy](#)
- [Running](#)

Some optional more advanced topics you may also wish to peruse:

- [Command Line](#) : Groovy can be launched in shell script mode
- [Compiling Groovy](#) : Groovy can be launched as any Java program
- [Embedding Groovy](#) : embedding Groovy in Java code using built-in capabilities
- [JSR 223 Scripting with Groovy](#) : embedding Groovy in Java code using JSR 223
- [Bean Scripting Framework](#) : embedding Groovy in Java code using the BSF

Your First Groovy

```
//hello.groovy
println "hello, world"
for (arg in this.args ) {
println "Argument:" + arg;
}
// this is a comment
/* a block comment, commenting out an alternative to above:
this.args.each{ arg -> println "hello, ${arg}"}
*/
```

To run it from command line

```
groovy hello.groovy MyName yourName HisName
```

Overview

Groovy classes compile down to Java bytecode and so there's a 1-1 mapping between a Groovy class and a Java class.

Indeed each Groovy class can be used inside normal Java code - since it is a Java class too.

Probably the easiest way to get groovy is to try working with collections. In Groovy List (`java.util.List`) and Map (`java.util.Map`) are both first class objects in the syntax. So to create a List of objects you can do the following...

```
def list = [1, 2, 'hello', new java.util.Date()]
assert list.size() == 4
assert list.get(2) == 'hello'
assert list[2] == 'hello'
```

Notice that everything is an object (or that auto-boxing takes place when working with numbers). To create maps...

```
def map = ['name':'James', 'location':'London']
assert map.size() == 2
assert map.get('name') == 'James'
assert map['name'] == 'James'
```

Iterating over collections is easy...

```
def list = [1, 2, 3]
for (i in list) { println i }
```

Once you have some collections you can then use some of the new collection helper methods or try working with closures...

Working with closures

Closures are similar to Java's inner classes, except they are a single method which is invocable, with arbitrary parameters. A closure can have as many parameters as you wish...

```
def closure = { param -> println("hello ${param}") }
closure.call("world!")
```

```
closure = { greeting, name -> println(greeting + name) }
closure.call("hello ", "world!")
```

If no parameter(s) is(are) specified before -> symbol then a default named parameter, called 'it' can be used. e.g.

```
def closure = { println "hello " + it }
closure.call("world!")
```

Using closures allows us to process collections (arrays, maps, strings, files, SQL connections and so forth) in a clean way. e.g

```
[1, 2, 3].each ({ item -> print "${item}-" })
["k1":"v1", "k2":"v2"].each {key, value -> println key + "=" + value}
```

Note: If a given closure is the last parameter of a method, its definition can reside outside of the parentheses. Thus the following code is valid:

```
def fun(int i, Closure c) {
  c.call(i)
}

// put Closure out of ()
[1, 2, 3].each() { item -> print "${item}-" } // 1-2-3-
fun(123) { i -> println i } // 123

// omit ()
[1, 2, 3].each ({ item -> print "${item}-" }) // 1-2-3-

// omit enclosing ()
[1, 2, 3].each { item -> print "${item}-" } // 1-2-3-

// normal
[1, 2, 3].each(({ item -> print "${item}-" })) // 1-2-3-

// using the fun function to do the same thing
[1,2,3].each {fun(it,{item -> print "${item}-"})} // 1-2-3-

def closure = { i -> println i}

//[1, 2, 3].each() closure // error. closure has been previously defined
```

Here are a number of helper methods available on collections & strings...

each

iterate via a closure

```
[1, 2, 3].each { item -> print "${item}-" }
```

collect

collect the return value of calling a closure on each item in a collection

```
def value = [1, 2, 3].collect { it * 2 }
assert value == [2, 4, 6]
```

find

finds first item matching closure predicate

```
def value = [1, 2, 3].find { it > 1 }
assert value == 2
```

findAll

finds all items matching closure predicate

```
def value = [1, 2, 3].findAll { it > 1 }
assert value == [2, 3]
```

inject

allows you to pass a value into the first iteration and then pass the result of that iteration into the next iteration and so on. This is ideal for counting and other forms of processing

```
def value = [1, 2, 3].inject('counting: ') { str, item -> str + item }
assert value == "counting: 123"
```

```
value = [1, 2, 3].inject(0) { count, item -> count + item }
assert value == 6
```

In addition there's 2 new methods for doing boolean logic on some collection...

every

returns true if all items match the closure predicate

```
def value = [1, 2, 3].every { it < 5 }
assert value
```

```
value = [1, 2, 3].every { item -> item < 3 }
assert ! value
```

any

returns true if any item match the closure predicate

```
def value = [1, 2, 3].any { it > 2 }
assert value
```

```
value = [1, 2, 3].any { item -> item > 3 }
assert value == false
```

Other helper methods include:

max / min

returns the max/min values of the collection - for Comparable objects

```
value = [9, 4, 2, 10, 5].max()
assert value == 10
value = [9, 4, 2, 10, 5].min()
assert value == 2
value = ['x', 'y', 'a', 'z'].min()
assert value == 'a'
```

join

concatenates the values of the collection together with a string value

```
def value = [1, 2, 3].join('-')
assert value == '1-2-3'
```

Installing Groovy

This page last changed on Jul 07, 2007 by [paulk_asert](#).

These instructions describe how to install a binary distribution of **Groovy**.

- first, [Download](#) a binary distribution of Groovy and unpack it into some file on your local file system
- set your `GROOVY_HOME` environment variable to the directory you unpacked the distribution
- add `GROOVY_HOME/bin` to your `PATH` environment variable
- set your `JAVA_HOME` environment variable to point to your JDK. On OS X this is `/Library/Java/Home`, on other unixes its often `/usr/java` etc. If you've already installed tools like Ant or Maven you've probably already done this step.

You should now have Groovy installed properly. You can test this by typing the following in a command shell:

```
groovysh
```

Which should create an interactive groovy shell where you can type Groovy statements. Or to run the [Swing interactive console](#) type:

```
groovyConsole
```

To run a specific Groovy script type:

```
groovy SomeScript.groovy
```

Installing Groovy and Grails on the Eee PC

This page last changed on Dec 28, 2007 by paulk_asert.

Have an [ASUS Eee PC](#)?



Worried that framework bloat might cramp your development practices on such a small device? Why not run Groovy and Grails on it! Shown here running Linux, several command shells, a Firefox browser, the Groovy Console, a database, a web container and Grails (which itself includes Hibernate and Spring) all in 512M of memory. And of course it has no (traditional) hard disk, so the whole footprint of Groovy, Grails and Java 6 is just a few hundred meg of the available flash memory.

Installing Java

- Given the relatively humble processor in the Eee PC, you probably want to use Java 6. Install it as per these [instructions](#). This is a flash memory vs speed trade-off.

Installing Groovy

- Then [download](#) and install the Groovy linux distribution. Ctrl-Alt-T will start up a terminal, then type:

```
sudo dpkg -i groovy-1.5.1.deb
```

Installing Grails

- You might also want to grab [Grails](#) and install that too by unzipping it.

Going further

- Google and you will find instructions for installing Eclipse and other applications too.

Running

This page last changed on Aug 15, 2007 by [user57](#).

Groovy scripts are a number of statements and class declarations in a text file. Groovy scripts can be used similarly to other scripting languages. There are various ways of running Groovy scripts

Using the interactive console

Groovy has a Swing interactive console that allows you to type in commands and execute them rather like using an SQL query tool. History is available and such like so you can move forwards and backwards through commands etc.

If you [install](#) a binary distribution of Groovy then you can run the Groovy Swing console by typing this on the command line.

```
groovyConsole
```

For a command line interactive shell type

```
groovysh
```

To see how to add things to the classpath see below.

Running Groovy scripts from your IDE

There is a helper class called

[GroovyShell](#)

which has a main(String[]) method for running any Groovy script. You can run any groovy script as follows

```
java groovy.lang.GroovyShell foo/MyScript.groovy [arguments]
```

You can then run the above Groovy main() in your IDE to run or debug any Groovy script.

Running Groovy scripts from the command line

There are shell scripts called 'groovy' or 'groovy.bat' depending on your platform which is part of the Groovy runtime.

Once the runtime is [installed](#) you can just run groovy like any other script...

```
groovy foo/MyScript.groovy [arguments]
```

If you are using Groovy built from CVS Head (after Beta-5, see below if you want to upgrade), apart from Groovy scripts, you may also now run different kind of classes from the command-line.

- Classes with a main method of course,
- Classes extending GroovyTestCase are run with JUnit's test runner,
- Classes implementing the Runnable interface are instantiated either with a constructor with String[] as argument, or with a no-args constructor, then their run() method is called.

To work from the latest and greatest Groovy see [Building Groovy from Source](#). Once built you'll then have a full binary distribution made for you in `groovy/target/install`. You can then add `groovy/target/install/bin` to your path and you can then run groovy scripts easily from the command line.

To see how to add things to the classpath see below.

Creating Unix scripts with Groovy

You can write unix scripts with Groovy and execute them directly on the command line as if they were normal unix shell scripts. Providing you have installed the Groovy binary distribution (see above) and 'groovy' is on your PATH then the following should work.

The following is a sample script which is

[in CVS](#)

. Save it as helloWorld.groovy.

```
#!/usr/bin/env groovy
println("Hello world")
for (a in this.args) {
println("Argument: " + a)
}
```

Then to run the script from the command line, just make sure the script is executable then you can call it.

```
chmod +x helloWorld
./helloWorld
```

Adding things to the classpath

When running command line scripts or interactive shells you might want to add things to your classpath such as JDBC drivers or JMS implementations etc. Do do this you have a few choices

- add things to your CLASSPATH environment variable
- pass -classpath (or -cp) into the command you used to create the shell or run the script
- It's also possible to create a `~/.groovy/lib` directory and add whatever jars you need in there.

Increasing Groovy's JVM Heap Size

To increase the amount of memory allocated to your groovy scripts, set your JAVA_OPTS environment variable. `JAVA_OPTS="-Xmx..."`

GroovyArticles

This page last changed on Apr 07, 2008 by [kks_krishna](#).

IDE Support

This page last changed on Sep 26, 2006 by paulk_asert.

Groovy is supported by the following IDEs and related tools:

- [Debugging with JSwat](#)
- [Eclipse Plugin](#)
 - [Debugging with Eclipse](#)
 - [Eclipse GroovyConsole](#)
 - [Eclipse Plugin Development](#)
 - [Code Completion Proposal](#)
 - [GroovyEclipse Specifications and Technical Articles](#)
 - [The Classloader Conundrum](#)
 - [GroovyEclipse Wish List](#)
 - [Eclipse Plugin FAQ](#)
 - [Grails Development Support](#)
 - [Grails Eclipse Feature](#)
 - [New Grails Project Wizard](#)
- [IntelliJ IDEA Plugin](#)
 - [GroovyJ Features and Wish List](#)
 - [GroovyJ Status](#)
 - [IDEA Open API](#)
- [IntelliJ IDEA Plugin \(JetBrains Edition\)](#)
 - [Wish List \(JetBrains Edition\)](#)
- [JEdit Plugin](#)
- [NetBeans Plugin](#)
- [Oracle JDeveloper Plugin](#)
- [Other Plugins](#)
 - [Emacs Plugin](#)
 - [UltraEdit Plugin](#)
- [TextMate](#)

Debugging with JSwat

This page last changed on Sep 24, 2006 by paulk_asert.

Overview

With Groovy 1.0 JSR-05, it is possible to use JSwat to step-debug with Groovy. JSwat is an open source debugger that uses the Java Platform Debugger Architecture. JSwat is available from the project home page at <http://www.bluemarsh.com/java/jswat/>. Version 2 is based on Swing and JDK 1.4. Version 2 is also available as a jEdit plugin. Version 3 of JSwat requires Java 5 and is build on the Netbeans Platform API. The instruction below pertain to using JSwat v3.9 .

You can use JSwat to debug uncompiled scripts as well compiled Groovy classes. You can step into Groovy methods and classes. You can also pull the Groovy runtime source and step from a script into the underlying Groovy runtime support classes.

Configuring JSwat

Running Windows XP, all configuration settings are stored in `%USERPROFILE%\jswat`. If you want to save the settings somewhere else, you can pass that directory on the command line. For example, if I was to save my settings in `c:\myCustomJswatDir`, type `jswat --userdir c:\myCustomJswatDir` .

Before you get started debugging, you have to configure JSwat classpath and source directory settings. In JSwat, you associate your runtime settings with *session* name. Groovy jars can be added to your debug session classpath by selecting `Session->Settings`. In the dialog box that comes up, you change the default session name to something more meaningful, like *Groovy Scripting* . Then click on the *Classes* tab and the *Add Jars/Folder* button to add the Groovy runtime jars. Navigate to your `GROOVY_HOME\lib` directory and *Shift-click* all of the jars to add them all at once. Click on the *Sources* tab and add the directory that contains the scripts you want to debug.

Debugging a Script

To simplest way to get started debugging is to open your script in JSwat, using `File->Open File`. Single click in the left gutter next the source line you want for a breakpoint. Then click on `Sesion->Start` . In the Launch Debuggee dialog, enter `groovy.lang.GroovyShell` for the Class Name:, and the name of your script, i.e. `HelloWorld.groovy` for Class Arguments:. Click the *Launch* button and you're now stepping through through your code.

Debugging Compiled Groovy Classes

Compile of your classes with `groovyc`. Add the directory with the compiled classes to the session classpath by clicking `Session->Settings->Classes->Add Jar/Folder`. Open your source file in JSwat using `File->Open File` and single click in the left gutter next the source line you want for a breakpoint. Then click on `Session->Start` . In the Launch Debuggee dialog, enter the name of the compiled Groovy class, i.e. `HelloWorld.class`, that has a `main()` in it. Click the *Launch* button and you're now stepping through through your code.

Stepping into the Groovy Runtime

Download the Groovy source archive and unzip it into `%GROOVY_HOME%`. Add `%GROOVY_HOME%\src\main` to the session sources by clicking `Session->Settings->Sources->Add Jar/Folder`. If click *Step Into* on a line of source in your script, you will then drop into Groovy runtime and be able to step though that Java code. This is a great way see what is going on under the covers.

Stepping over the Java and Groovy Runtime

If you're only concerning with stepping into one Groovy script from another and want to by pass all the runtime code, click on `Tools->Options->Debugging->General->Stepping Excludes` and add the packages you want skip. The following list would probably be a good starting point: `groovy., org.codehaus.groovy., gjdk.; java., sun.*, org.apache.*`

Debugging Compiled JUnit Tests

Use `junit.textui.TestRunner` or `groovy.lang.GroovyShell` for the Class Name and your test class for the Class Arguments.





Eclipse Plugin

This page last changed on Apr 16, 2008 by [eggeral](#).

The Groovy Eclipse Plugin allows you to edit, compile and run groovy scripts and classes.

 Note that the plugin is work in progress. You can check the current status of the plugin here: [issues and bugs](#)

Eclipse version compatibility

-  Eclipse 3.0 : not working; there are dependencies to the 3.1 AP
-  Eclipse 3.1 : not working with version 1.0.1 of the plugin. Works with version 1.0.0.20070118
-  Eclipse 3.2 : working
-  Eclipse 3.3 : working - (based on minimal initial testing)

Quick Start

For the installation of the Groovy Eclipse Plugin follow this [PDF presentation](#).

The ["Hello World"](#) screen cast shows you how to write a Groovy "Hello World" application using Eclipse.

Update Site

The update site containing the most recent release is here: <http://dist.codehaus.org/groovy/distributions/update/>

- Go to: **Help -> Software Updates -> Find and Install -> Search For New Features**
- Click on **New Remote Site**
- Enter a name (eg: Groovy) in the **Name** field
- Copy the URL from above into the **URL** field and press **OK**
- **Check** the new Groovy repository and press **finish**
- Under **Select the Features to Install** check the Groovy check box (be sure to get the latest version) and press **Next**
- Accept the agreement and press **Next**
- If the default location looks okay press **Finish** (this will download the plugin)
- If you get a warning that the plugin is unsigned click **Install** or **Install All**

This should download and install the Groovy plugin. It may require a restart of Eclipse to make sure it is loaded okay.

If you're interested in trying the latest development version, the update site is: <http://dist.codehaus.org/groovy/distributions/updateDev/>

Create a Groovy Project

To create a basic Groovy project in Eclipse perform the following steps:

- Go to: **File -> New -> Project**
- Select **Java Project** and press **Next**
- In the **Project Name** field enter the name of your project (GroovyJava for this example)
- Under **Project Layout** select **Create separate source and output folders** and press **Finish**
- In the **Package Explorer** find the newly created project, right click, and select **Groovy -> Add Groovy Nature**

So far you should have a **src** folder, a **bin-groovy** folder, and several libraries. There is also a **bin** folder that was created by Eclipse, but is hidden due to exclusion filters. The next steps are needed to make the **bin-groovy** folder the default output folder, and to connect it to the **src** folder so that the debugger will know where to find the associated source and classes:

- In the **Package Explorer**, right click on the "GroovyJava" project, and select: **Build Path -> Configure Build Path**

- Select the **Source** tab and then use the **Browse** button to change the **Default Output Folder** from **bin** to **bin-groovy**
- Press **OK, OK**

This will expose the **bin** folder in the **Package Explorer**. I'm not sure why the plugin creates a **bin-groovy** directory. Perhaps there are other "bin" files that are best kept separate from the Groovy classes, or perhaps one of the original versions of Eclipse didn't create a "bin" directory automatically. Some day when someone has a clear idea of the usefulness of this, or lack thereof, we can clean up my instructions.

Download and build from Subversion

This section is for those who want to do development work on the Eclipse plugin. More specific information regarding the wish-list and standards can be found at [Eclipse Plugin Development](#). You may also want to join the groovy-eclipse-dev mailing list by subscribing here - <http://xircles.codehaus.org/lists/eclipse-plugin-dev@groovy.codehaus.org>.

See the [Codehaus Subversion page](#) for general information on how to access the repository. See the [Subversion home page](#) if you are new to Subversion in general. To simply view the plugin code, use [FishEye](#).

The plugin source contains Groovy source files. You will need to be able to compile Groovy in order to build the plugin. The easiest method is to download the released plugin from the update site (<http://dist.codehaus.org/groovy/distributions/update/>) or the development version of the plugin from the development update site (<http://dist.codehaus.org/groovy/distributions/updateDev/>).

The plugin modules depend on TestNG. Instructions for downloading the TestNG Eclipse plugin are on the [TestNG Download page](#).

Checkout the plugin modules by running the following command:

```
> svn co http://svn.codehaus.org/groovy/trunk/groovy/ide/groovy-eclipse
```

Each module already contains all the information Eclipse needs to create the project properly (i.e. .project, .classpath and other files). From Eclipse, "Import" the projects into your workspace.

Detailed description of how to checkout using the Eclipse Subclipse plugin:

1. Select the Window -> Open Perspective->Other -> SVN Repository Exploring.
2. In the context menu of the SVN Repository pane, select New Repository Location
3. Enter the following URL: <http://svn.codehaus.org/groovy/>
4. Navigate to /trunk/groovy/ide/groovy-eclipse and select all of the projects under **trunk/groovy/ide/groovy-eclipse**.
5. Right-click to get the context menu and select **Check out** (not Check out as)
6. Now you should have all of the groovy-eclipse projects in your package explorer view

Testing the plugin

It might be useful to test the plugin before you use it in your main eclipse installation. There are two Eclipse test projects called GroovyEclipseTests and org.codehaus.groovy.eclipse.core.test. To run them right-click on the project and select Run As>JUnit Plug-in Test.

Building the Update Site

To build the update site for use with your main eclipse installation follow these simple instructions:

1. Open the **site.xml** file in the GroovySite project.
2. Click **Build All** button.
3. This will build an update site under the GroovySite project.

Installing the update site that you built

The update site you just created can now be installed with the Eclipse update manager. You can install the Groovy feature by following the instructions in the [Update Site](#) section above, but using a Local Site pointing to the GroovySite directory that you just built, instead of a Remote Site.

Filing an issue (bug report):

<http://jira.codehaus.org/secure/BrowseProject.jspx?id=10242>

under the "GRECLIPSE" category

Debugging with Eclipse

This page last changed on Dec 12, 2006 by [jshickey](#).

It is possible to step through compiled Groovy classes in Eclipse using the Java Debugger by doing the following:

1. Setup "Step filtering" in Eclipse Window->Preferences->Java->Debug->Step Filtering to enable filtering the default packages and add filtering the following packages: `org.codehaus.*`, `groovy.*`
2. Select Project, Debug and in the popup screen
 - a. Select `Java Application` (not Groovy)
 - b. Select `New` at the bottom
 - Give an appropriate name (use the Class that you are about to debug)
 - Type the project name that has the class or select using the Browse button
 - Enter the name of the main class

Setup Debugging for JUnit Test Cases

1. This is the same process as above with the following exceptions:
 - In the Main tab, the main class is always `junit.textui.TestRunner`
 - In the Arguments tab, the program arguments is where the appropriate class name (use the Class that you are about to debug) is entered. (eg. `- mypackge.HelloWorld`).

Debugging isn't perfect yet in the plugin but it very usable. Note that you will have to "step into" in closures instead of stepping "over" them; even though they are in the same file, a separate class is created for each closure. Also, when inspecting variables, you may need to drill down through the metaclass to get to the object you are trying to inspect. Adding nicely formatted `toString()` methods to your Groovy objects greatly facilitates debugging.

The first time you try to debug a closure in Eclipse, you will receive a dialog box like the one below. Click on the "don't tell me again message" and continue. You will be able debug the

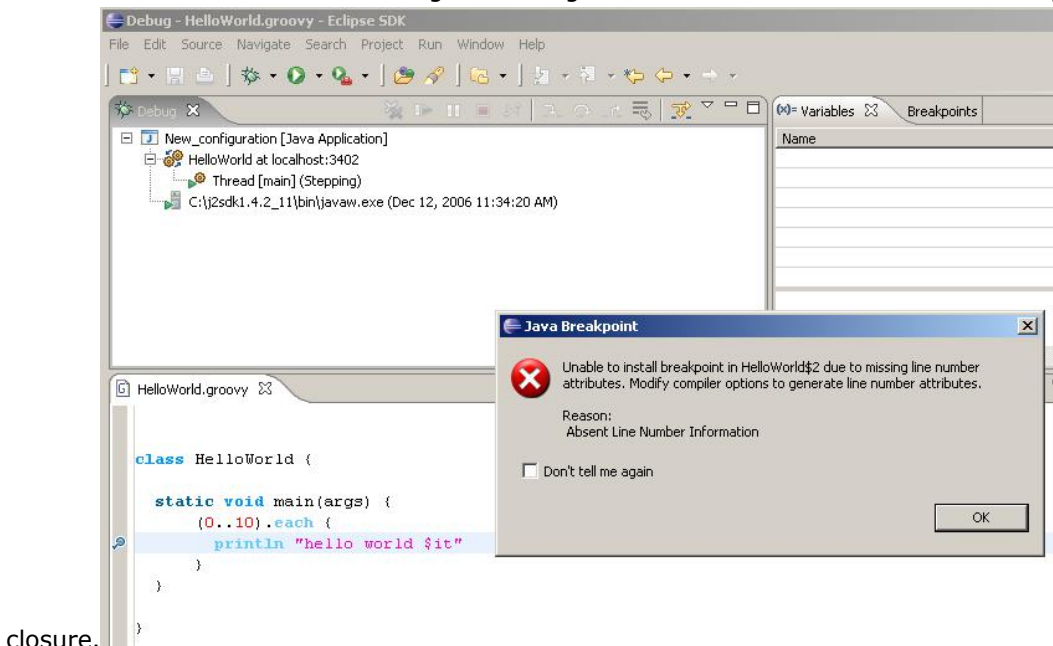

Eclipse GroovyConsole

This page last changed on Jan 14, 2007 by [tomstrummer](#).

The [Eclipse Plugin](#) can be used to launch a Groovy Console or Groovy shell* from any Groovy **or** Java project. When the console is launched, *you will have access to all classes on the project's build path*.

This is an easy way to quickly test any Java or Groovy code and immediately view the output. The typical alternative would be to create a JUnit test, run the test, check the output, modify the code, run the test, check the output modify the code.... In any case, this is a lot easier because you can do it all without terminating the JVM.

Example Usage

You can use the Groovy Console from Eclipse to quickly inspect the functionality of your Java code, or even to inspect the output of a not-so-well-documented third-party library. This is particularly convenient because you don't have to create a JUnit test.

Say you want to test the `FilenameUtils` class...

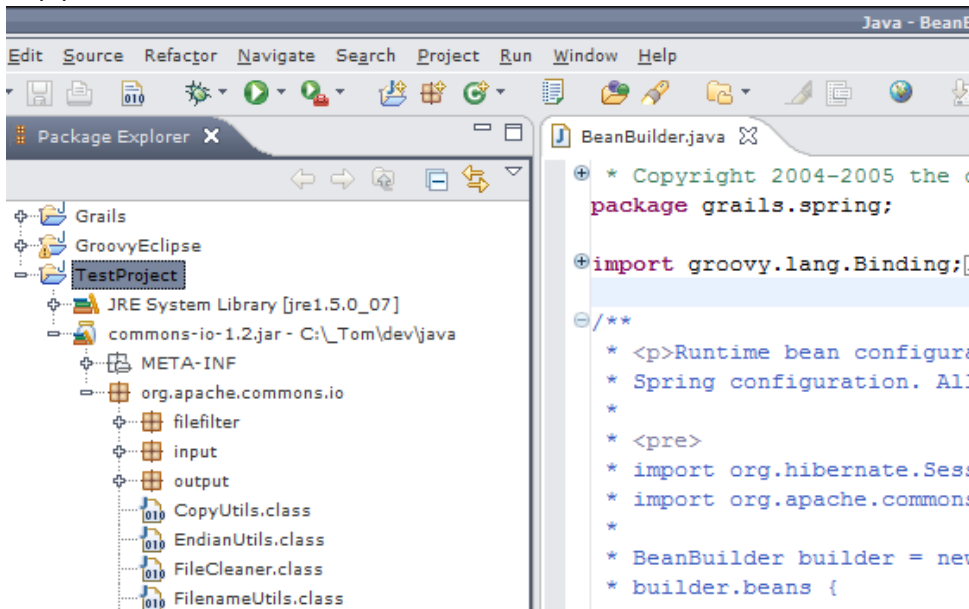

Note that this is a plain Java project.

Right click on the project and select **Groovy -> Groovy Shell**

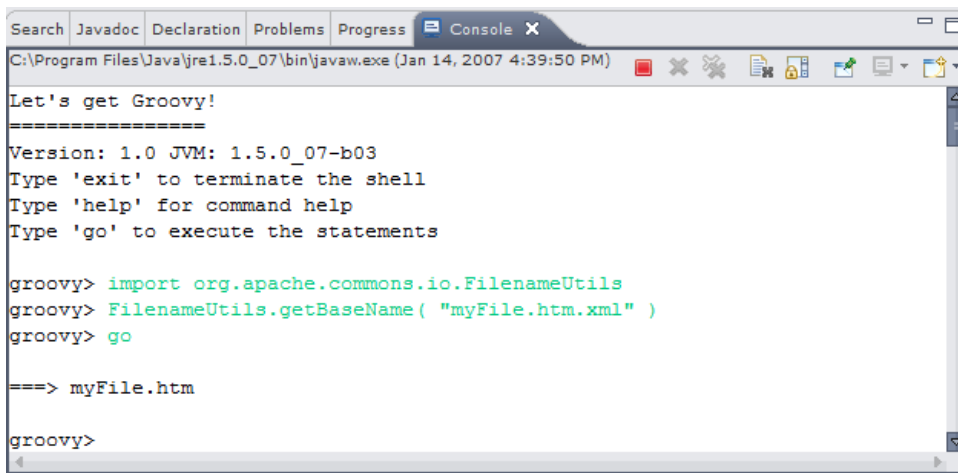

Test the classes in the Eclipse console:

A screenshot of an Eclipse IDE console window. The title bar shows 'Console' and the path 'C:\Program Files\Java\jre1.5.0_07\bin\javaw.exe (Jan 14, 2007 4:39:50 PM)'. The console text reads: 'Let's get Groovy!', followed by a separator line '=====', then 'Version: 1.0 JVM: 1.5.0_07-b03', and instructions: 'Type 'exit' to terminate the shell', 'Type 'help' for command help', and 'Type 'go' to execute the statements'. The user enters 'groovy> import org.apache.commons.io.FilenameUtils', 'groovy> FilenameUtils.getBaseName("myFile.htm.xml")', and 'groovy> go'. The output is '====> myFile.htm', followed by 'groovy>' on a new line.

```
Search Javadoc Declaration Problems Progress Console X
C:\Program Files\Java\jre1.5.0_07\bin\javaw.exe (Jan 14, 2007 4:39:50 PM)

Let's get Groovy!
=====
Version: 1.0 JVM: 1.5.0_07-b03
Type 'exit' to terminate the shell
Type 'help' for command help
Type 'go' to execute the statements

groovy> import org.apache.commons.io.FilenameUtils
groovy> FilenameUtils.getBaseName( "myFile.htm.xml" )
groovy> go

====> myFile.htm

groovy>
```

Note that you still had to type the **import ...** statement. That is because, as in any Groovy script, you need an import or a fully qualified class name. The important thing here, is that all project libraries and code are immediately accessible in the Groovy shell.

The Groovy Swing-based console can be used as well, but since it takes significantly longer to load the GUI, it is often more convenient to run the command-line shell for simple tests.

Future Improvements

A future goal is to integrate the Groovy console with the Eclipse debugger. One could then dynamically exercise code from the console, then modify the code. Through the magic of Eclipse's hot code replace, the developer could 'work it' until it demonstrates the correct behavior – all in one invocation of the JVM.

Notes:

- The Groovy shell is the class name for the console that runs on the command line, without Java Swing widgets.

Eclipse Plugin Development

This page last changed on Feb 15, 2008 by [tram](#).

Overview

This page is intended to make it easier for those who want to do development on the Eclipse Plugin. It's purpose is define what features should be available in the plugin, what source code modules are implement those features. It would also be good to include links to outside reference material that is directly relevant to the development of this type of plugin.

[Eclipse FAQ for implementing support for your own language](#)

Tracing

The Groovy plugin uses the built in tracing support to output debugging messages. While doing Eclipse plugin development, you can enable tracing in Eclipse by selecting Run->Debug->Tracing and selecting which plugins you want to see messages for. Use the static method `GroovyPlugin.trace("some message")` to output debug messages instead of `System.out.println` (or `log4j`).

Text Editor Syntax Color Highlighting

Features / Proposed Changes:

- Highlight GJDK keywords (could be done in `org.codehaus.groovy.eclipse.editor.GroovyTagScanner`)
- Highlight methods (requires accessing Document Model / Groovy AST)
- Highlight expressions inside of GStrings (requires accessing document model)
- Enable/Disable these features with a Groovy preferences page

Syntax color highlighting is accomplished in `org.codehaus.groovy.eclipse.editor.GroovyPartitionScanner.java` and `org.codehaus.groovy.eclipse.editor.GroovyTagScanner.java`.

Look at the Groovy outliner `org.codehaus.groovy.eclipse.editor.contentoutline.GroovyContentOutline.java` to understand how the Eclipse DOM works and how to access the Abstract Syntax Tree for a Groovy compilation unit.

Debugger

[Eclipse.org Article on writing your own debugger](#)

Features / Proposed Changes:

- Update the breakpoint code to create Java breakpoints to support using the Java debugger (`org.codehaus.groovy.eclipse.actions.ToogleGroovyBreakpointAction`)
- Enable the variable window to display user friendly values for Groovy reference objects to avoid drilling down to see the actual value

Builder / Nature

Features / Proposed Changes:

- Add preferences page option to enable/disable saving all compiled class files to project build directory after the source files are saved

Preferences Page

Features:

GroovyEclipse Wish List

[GroovyEclipse Wish List](#)

Grails Support

[Grails Development Support](#)

Code Completion

[Code Completion Proposal](#)

Specification and Technical Articles

[GroovyEclipse Specifications and Technical Articles](#)

Code Completion Proposal

This page last changed on Feb 07, 2007 by [emp](#).

Code Completion Proposal

The contents of this documents are subject to change at any time!

Note that the underscore `_` is used to indicate the current location of the caret.

Reconciling Changes

The Quick Path

In order to get up to speed with actual completions, we can take advantage of the dynamic nature of groovy. That is, any expression that looks like a variable or property will compile to an AST. So say we want to complete "toString", then `mystr.toS` is a valid Groovy expression and will compile. The reconciler will attempt to recompile the Groovy class whenever a completion is requested. In many cases the class will compile without error, and an `ASTNode` is available with which to compute possible completions.

The Best Path

An error correcting parser is required to deal with cases where the source code cannot be compiled. For example:

```
for (my_) { } // for expression is not complete
for (i in my_) // no braces
for (i in my_) { // unclosed braces.
```

All of the above can be recovered from with various changes to the groovy.g grammar and custom error correcting code where needed.

Code Completion

Completion Contexts

Completion only makes sense in certain contexts: Outside a class: A package:

```
package com._
```

An import:

```
import a._
```

A variable access/method call/class name:

```
my_
```

A property access/method call:

```
a.my_
```

Inside a class:

Completion for overriding methods, super class fields and method calls. Inside a method: fields, methods, local, parameters Inside a closure: as in inside a method, but also specialized, for example, Grails constraints definitions.

Code completion

Given an `ASTNode`, we want to know its type. A single magic method, `getType(ASTNode node)`, is needed. This method returns the type if it is known, or request it from other sources. Some examples or type sources: a type inference engine, using a database of predefined completions for that name, or even asking the user. `h3. Completion Processor Plug-ins` The completion engine uses a collection of completion processor plugins to create a completion list. For any completion case, a completion processor which is linked to some completion context and some `ASTNode` class, can be implemented. For example:

```
class MyFrame extend JFrame {
  int party;
  getP_ // completions: add getParty() getter, or override getPreferredSize()
}
```

In this way, completions can be implemented by individuals without affecting the main code base, and when they are ready for release, they can be released as a plugin or rolled into a main completion plugin. Completion plugins will be sent the following information: If the completion is in the form of a single identifier (like a variable name or method name), then the `ASTNode` and the partial name will be sent to the completion processor. For example:

```
def myMethod() { do_ }
```

The completion processor will get the `ASTNode` representing 'do' as well as the string 'do'. For completions that look like property accesses, the `ASTNode` of the parent will be sent to the processor:

```
def myMethod(){ thing.do_ }
```

The `ASTNode` for 'thing' and the prefix 'do' is sent to the processor. If there is not prefix like in the case of 'thing._', then the prefix is null.

Completion Without Inference

This is quite easy: `getType(ASTNode node)` simply returns the type of the `ASTNode`. If the node represents a statically typed name, then the type is returned. Else `java.lang.Object` is returned.

Type Inference

Unless the Groovy code is being used from Java, quite often names are not statically typed. Luckily, at some point types can be found because of Groovy's close ties with Java.

Simple Inference

Local variable initializers and assignments:

```
def myInt = 10 // An Integer
```

```
myInt = "Twenty" // A String
```

Field initializers and assignments:

As above.

Return types of method calls.

Parameters:

```
def myMethod(a, b) { }
```

Searching for calls within the same class will often give us a type.

Conundrum: Methods may return different types in Groovy. Does `getType()` return an array?

The Fun Stuff aka, Not So Easy Inference

Complex assignments:

```
def myInt = 10 + 20 + thing[20] / otherThing
```

Keeping track of list types:

```
def list = [10]
```

```
list[0].toH_ // complete with toHexString()
```

Completing on Subtypes:

```
java.awt.Shape myShape = ...  
myShape.width // assumes shape might be a Rectangle2D  
How far does one go? How fast is this? What happens in this case:  
Object myShape // Yikes, the whole class path can be a completion.
```

GroovyEclipse Specifications and Technical Articles

This page last changed on Apr 12, 2007 by emp.

The Classloader Conundrum

An article describing the class loader problems faced by GroovyEclipse in order to support different versions of Groovy.

The Classloader Conundrum

This page last changed on Apr 12, 2007 by emp.

GroovyEclipse and the ClassLoader Conundrum

Note that this document is likely to contain inaccuracies at this time - in its current form it should be thought of as a brain storm. This ClassLoader business has been known to explode heads, and so learning about it progresses at a slow and careful pace.

The Problem

A problem with implementing GroovyEclipse in Groovy is that development is tied to a single version of Groovy. If compilation is allowed with another version of Groovy, duplicate classes will occur which leads down the path of pain.

Example:

```
groovy-1.0.jar                groovy-1.0-all.jar
GroovyEclipse                /-----> SomeClass AST
Some Analysis-----/
```

Now the analysis which uses a ClassNode class loaded from groovy-1.0.jar is trying to analyze some AST which contains a ClassNode loaded from groovy-1.0-all.jar. These are not equal, and so the JVM will make that fact known in the most unpleasant way possible.

The Solutions

Do Nothing

GroovyEclipse is locked to the current release of Groovy. This sucks but it is the current state of affairs.

Maintain Multiple GroovyEclipses

Maintain multiple GroovyEclipses locked to the different Groovy versions. The programmer needs to enable different versions of GroovyEclipse and restart the IDE for the change to take place.

This is not very nice if working on different projects that depend on different versions of Groovy.

Create Plugins that Wrap groovy-*.jar

Enable whichever one you need and restart the IDE for the change to take place. The end result is similar to maintaining multiple GroovyEclipse versions.

Hope and pray that the org.codehaus.groovy.ast.* packages don't change

Extract these packages into their own jar. Maintain custom groovy versions that link to this common jar. These groovy versions also contain implementations of the compilation interface, IGroovyCompiler. The programmer can select a version per project/global scope. So:

```
eclipse-groovy-ast.jar
/          |          \
/          |          \
/          |          \
GroovyEclipse  eclipse-groovy-1.0.jar  eclipse-groovy-1.1.jar
```

The eclipse-groovy-*.jars implement IGroovyCompiler extending a compilation extension point. GroovyEclipse loads these extensions and can use which ever one is necessary. Multiple interfaces may be loaded by a class loader without problems.

This might even work. As long as extracting eclipse-groovy-ast.jar is feasible in the long term. For each version of Groovy, there is a little work to package it up as a GroovyEclipse plugin.

Code the plugin in Java

And drive GroovyEclipse developers to take up fishing ... forever. And there will still be class loader problems, just not as many.

Convince Groovy developers to extract interfaces for AST classes

Yes, that's it. No, probably not. However GroovyEclipse could have such interfaces and implementations that are simply proxies for the AST. This is a lot of work, but probably the most future proof. New features would be extension interfaces. And since this is only for analysis, the proxies would only be created on demand when analysis tools want an AST.

There is still the problem of ASTs containing references to classes in the groovy runtime. And also, how much work is really involved? AST interfaces. AST visitor interfaces, which means a new visitor implementation. What else? And will it never be necessary to dip into the groovy runtime itself?

Conclusion

There is still much to be understood and more schemes to think about. The solutions above are a first crack at trying to find a solid solution to the class loader problem. Hopefully a better solution and easy to integrate solution will surface with a little more brainstorming.

GroovyEclipse Wish List

This page last changed on Mar 10, 2008 by [dynoweb](#).

This is a wish list to help guide further development of GroovyEclipse. Please add your own entries, and increment the vote count for features that interest you.

Refactoring

rename method/variables (+8)

extract method (+4)

extract variable (+1)

inline method/variable

Groovy Source Editor

Code Formatting (+9)

Typing

Automatically insert braces at the right position.

Quote insertion. Either automatically step over the second quote when typed or don't do it at all. Perhaps a disable property would work. (+1)

The Java preferences are now honored so one can disable this property

Tab indenting with spaces (+2)

Pressing the tab key to create an indent should honor the formatting settings, i.e. if "use spaces" is set, the tab key should insert space characters, not a tab. A workaround for this work could be the plugin AnyEdit which can convert Tabs to spaces.

Code Assist

Any type of automatic insertion of code falls under this category.

Code Complete

Complete within Method Scope (Implemented)

Typed and simple inferred typed completions within method scope for types, properties and methods.

Complete within Module Scope (+6)

This is where completions of packages and imports.

Code Assistance

Code Templates (Implemented)

As with Java, type 'for' and get 'for (i in 0..n) { }'.
At this time there are formatting issues

Override Method (Implemented)

Within the scope of the class, type the start of the method to override and hit ctrl+space.

Implement Getter/Setter (Implemented)

Type 'get' or 'set' and choose from a list of possible getters and setters to insert a default implementation.

Quickfixes for Compiler Errors (+7)

Auto Import on Completion (Implemented)

Imports are not inserted in sorted at this time. Sometimes completion doesn't work

Organize Imports (+1)

Code Browsing

Hyperlink To Type (+8)

This feature exists but does not function fully. Ctrl + Click sometimes works. It needs to be rewritten and 'done right'

Find All References (+6)

Type Hierarchy (+2)

Groovy Search (+2)

Much like Java search.

Outline View

Enable sorting (alphabetical order/Order of appearance in File) and filtering (show or hide: private, public, fields, getters & setters, constructors)

Testing (Implemented)

Ability to run Groovy based tests in a similar fashion to standard JUnit tests, with matching green/red runner results view.

This would be the familiar "Run as Groovy test" and has a view recording the test results.

Testing (Not Implemented Yet)

Ability to run Groovy based integration and unit tests for Grails applications.

Debugger

Grails application testing

Should be able to start a Grails application from Eclipse and set break points that would break when the execution of the web application would reach that break point. Should be able to inspect Groovy variables. Would be nice if code changes in a method when saved would set the current execution point at the first line of the method.

Filtering of Stack Traces (+3)

This should be selectable (somewhere something like a Checkbox or so) either you see the full stack or you see only Groovy classes in your project.

A Groovy-aware Display view (+2)

Like the Java "Display" view in the debugger, but able to evaluate groovy expressions within the current context.

Step directly into target method (+1)

When debugging in groovy code, stepping into should if possible bypass all the reflection and metaclass stuff, and take you directly to the target method

Documentation

On-line Help (Done)

The definitive documentation for the Groovy Eclipse Plugin should be available in the Eclipse on-line help.

Showing documentation (+8)

Method documentation of the function or the class documentation while hovering over the word (just like in the Java plugin)

Add Doc in the style of the Java Plugin (+3)

When sitting on a method definition or class definition, and opening the popup-menu there should be an entry: "Create Block Comment", which should result in something like:

```
/**
 * @param
 * @param
 * @return
 */
```

There should be another popup-menu Entry: "Update Block Comment", which should check if the comment is there already it should check, if all parameters are there and add or delete if necessary (just dreaming 😊)

Miscellaneous

Running/managing groovy scripts

The IDE understands a groovy script that is not a class, showing it's attributes in the object browser, allowing the user to run it and see the results, etc.

Support for PDE

Add the ability to write plugins using Groovy. Should support execution, debug and build of Groovy language made Eclipse plugins.

Eclipse Plugin FAQ

This page last changed on Apr 16, 2007 by uwe.hartl@gmx.net.

1. **When I try to debug my application, the plugin says that it can't find the source?** This is most commonly caused by trying to debug the application with Groovy Launch configuration instead of a Java Launch configuration.
2. **When I load a Groovy file, the outline view is blank?** The outline uses information returned from the Groovy compiler. If something is preventing the file from being compiled, then the outline view will remain blank until a successful compilation takes place.
3. **When I edit a Groovy file, the outline view doesn't update?** The outline uses information returned from the Groovy compiler. The compiler is invoked when the Eclipse starts up and after each file change. If something is preventing the file from being compiled, then the outline view won't change until a successful compilation takes place.
4. **When my Application throws an Exception, the Stack Trace is not filtered for the Groovy Files:**

You can filter with this method:

```
def pst(e){
  def newTrace = []
  e.stackTrace.each{te->
    if (te.toString() =~ /. *groovy:\d*/) newTrace << te
  }
  e.stackTrace = newTrace
  e.printStackTrace()
}
```

5.

Grails Development Support

This page last changed on Feb 15, 2008 by [tram](#).

User Stories

- [Grails Eclipse Feature](#)(Ramon, In progress)
- [New Grails Project Wizard](#)(Ramon, In progress)
- Project Navigator
- Project Navigator Actions
- Grails Pluggins support
- Grails Console View
- Running a Grails server embedded in the IDE and being able to step debug the application. Groovy provides all the information in the classes necessary to enable step debugging of Groovy code
- Code navigation with keyboard shortcuts and CTRL+click between Grails artifacts like controllers domain classes etc.
- Code completion for things like dynamic finders and persistent methods like save/delete/findAll/findBy* on domain classes
- Auto-completion of Grails tags in GSPs
- Integration of an embedded Grails console to be able to execute arbitrary scripts against a running application
- Being able to right-click execute Grails unit tests and get green/red bars etc.
- Being able to right-click on a Grails project and execute all unit tests
- Better editor support for groovy files. This means autocompletion and so on.
- Special outline views for Domain-Classes, Controllers and Views
- Graphical editor for Domain Classes, with a UML-like or ER-like view

- Integration of every Servlet-Container to test the Grails-App. The best solution were intergration into webtools
- XP Refactor support (e.g. rename methods/groovy file names and cascade changes to all dependencies)

Grails Eclipse Feature

This page last changed on Feb 15, 2008 by [tram](#).

This is more a deployment need. The groovy update site will contain a Grails feature that will developers the choice of installing Grails support.

New Grails Project Wizard

This page last changed on Feb 15, 2008 by [tram](#).

This wizard will allow the creation of a new Grails project from inside Eclipse. For the initial version the wizard will rely on an already defined `GRAILS_HOME` in order to run the `create-app` command.

Acceptance Criteria:

- The default directory for the new application will be the active workspace.
- The user can specify a different physical location for the project.
- The Wizard will be available from the "New Project List" in Eclipse
- The resulting projects will have a Grails Nature associated with it.

IntelliJ IDEA Plugin

This page last changed on Aug 12, 2007 by [glaforge](#).

 This plugin is not maintained anymore. Users interested in using IntelliJ IDEA to develop Groovy code should have a look at JetBrains' own Groovy and Grails plugin. For more information on this plugin, please visit the [JetBrains JetGroovy plugin page](#).

With GroovyJ, we're aiming to offer full integration of Groovy into JetBrains' [IntelliJ IDEA](#).

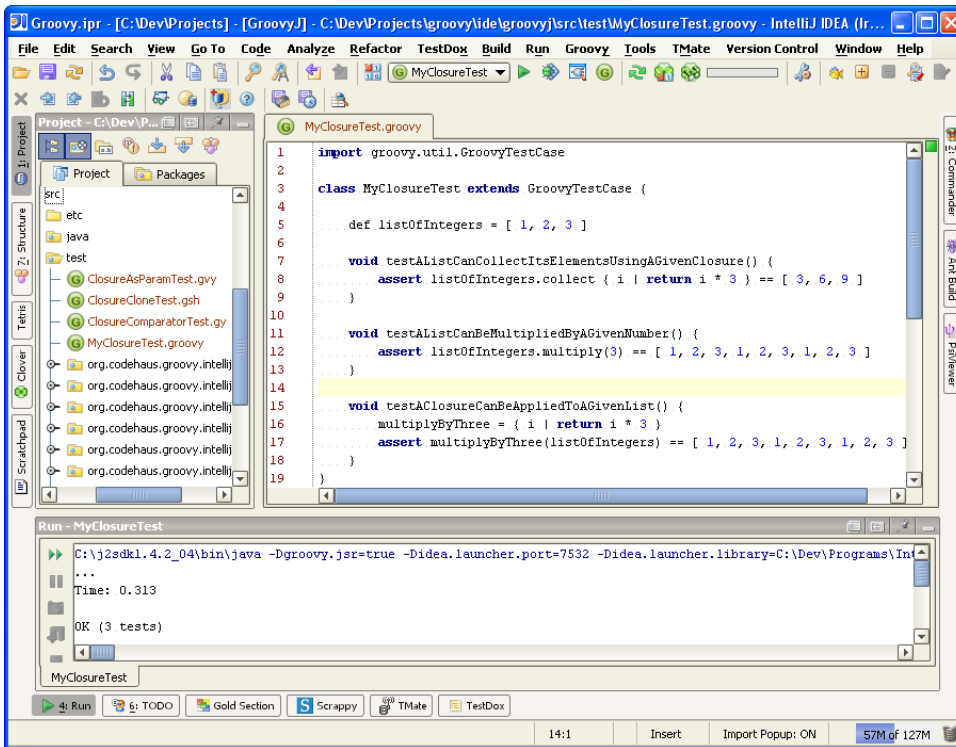

Latest News

Availability

The first public release of *GroovyJ* is available through IDEA's plug-in manager under the **Custom Languages** category and requires IDEA 5.0 build #3378 or higher, which you can download from the [IntelliJ Early Access Program \(EAP\)](#) site and use with a free and time-limited license. *You will need to create an EAP account in order to download EAP builds.*

We provide a few pages to help you track the status of the plug-in:

- [GroovyJ Status](#)
- [GroovyJ Features and Wish List](#)
- [IDEA Open API](#)

Releases

New versions of *GroovyJ* will be released through IntelliJ IDEA's [Plug-in Repository](#) and will be announced on the [Plugins](#) forum.

Miscellaneous

In case you had previously copied the [Groovy Script Files.xml](#) syntax file to one of the following locations:

- `<USER_HOME>/.IntelliJIdea/config/filetypes` (Unix/Windows)
- `~/Library/Preferences/IntelliJ IDEA/filetypes` (Mac OSX)

you will need to shutdown IDEA and remove that file prior to downloading the plug-in.













CVS modules

The [groovy-intellij](#) module which targeted IDEA 4.5 has been superceded by the [groovyj](#) module which targets the forthcoming IDEA 5.0.





GroovyJ Features and Wish List

This page last changed on Sep 24, 2006 by paulk_asert.

Prioritised Features

1.  groovy-classes-and-scripts [GROOVY-602](#) Run
2.  groovy-classes-and-scripts [GROOVY-607](#) Compile
3.  plugin-should-include-a-default-runtime-for-scripts [GROOVY-797](#) Groovy
4.  highlighting [GROOVY-601](#) Syntax
5.  parsing errors and warnings [GROOVY-604](#) Provide
6.  imports [GROOVY-605](#) Automatic
7.  completion facilities [GROOVY-606](#) Add auto-
8.  refactoring capabilities (within groovy, java to groovy, and groovy to java) [GROOVY-608](#) Provide
9.  GroovyTestCases as unit tests with the integrated JUnit runner [GROOVY-603](#) Run
10.  Outline/File structure view [GROOVY-614](#) Provide an

Wish List

1.  navigation between scripts and classes [GROOVY-610](#) Easy
2.  beautifier for groovy [GROOVY-774](#) code
3.  actions (light bulbs / quick fixes) [GROOVY-611](#) Intention
4.  Explorer/New/Groovy File [GROOVY-787](#) IDEA/File
5.  Scratchpad tool window to play interactively with Groovy [GROOVY-784](#)



Alternative

The [BSF Console](#) plug-in offers a console for executing Groovy scripts interactively.

Open JIRA Issues

Error rendering macro: java.io.IOException: Could not download: <http://jira.codehaus.org/secure/IssueNavigator.jspa?view=rss&pid=10242&component=11040&statusIds=1&statusIds=3&statusIds=4&statusIds=10001&sorter/field=status&sorter/order=ASC&sorter/field=priority&sorter/order=ASC&sorter/field=priority&sorter/order=DESC&tempMax=25&reset=true&decorator=none>

GroovyJ Status

This page last changed on Sep 24, 2006 by [paulk_asert](#).

This page gathers information about the status of GroovyJ and recaps the milestones of the development.

[GROOVY-797](#) - Default Groovy Runtime

The plug-in automatically installs the Groovy runtime (*currently a snapshot of the forthcoming JSR-03 release*) as a **global library** prefixed with "**Groovy from GroovyJ**".

From then onwards, whenever a module is added to a given IDEA project, this Groovy runtime is automatically selected as a module dependency for your convenience. This facilitates the seamless execution and compilation of Groovy scripts and classes in very much the same way as ordinary Java classes.

As new versions of the plug-in are made available through IDEA's plug-in manager, installing upgrades will transparently update the default Groovy runtime. This mechanism **will not** interfere with your current IDEA setup, in particular if you would rather use a different version of Groovy to run your scripts.

FileType support

The plug-in automatically registers Groovy into IDEA's file type subsystem. Thus files with one of the **groovy**, **gvy**, **gy**, and **gsh** file extensions are recognised as Groovy scripts and treated as such as illustrated in the screenshot below:

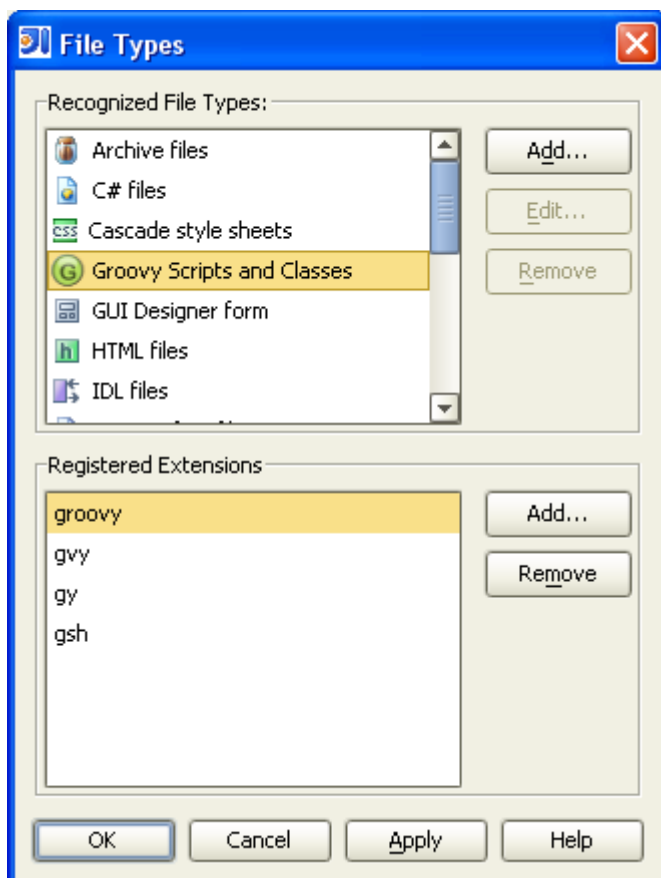

Currently, syntax highlighting (see [GROOVY-601](#)) is done using IDEA's built-in highlighter for J2SE 5. This is because Groovy's JSR grammar was itself derived from the ANTLR grammar for J2SE 5.

GROOVY-602 - Run Configuration

GroovyJ allows users to run scripts and classes, just like they would run Java programs in IDEA:

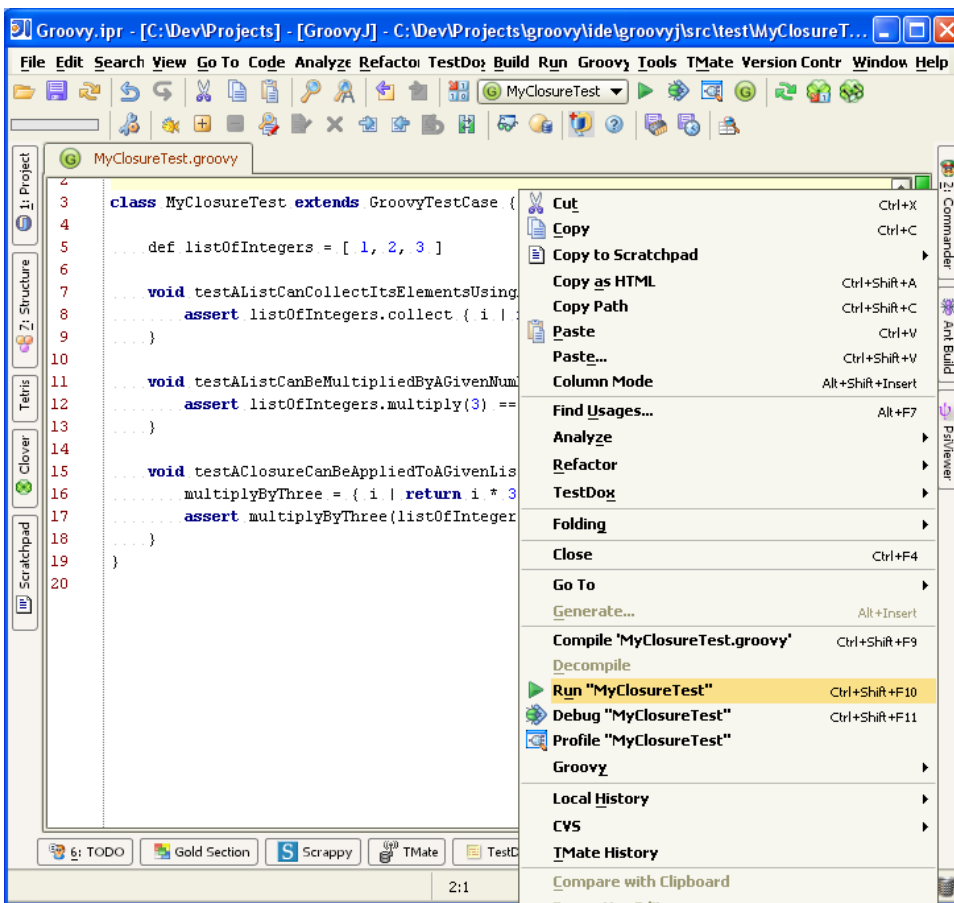
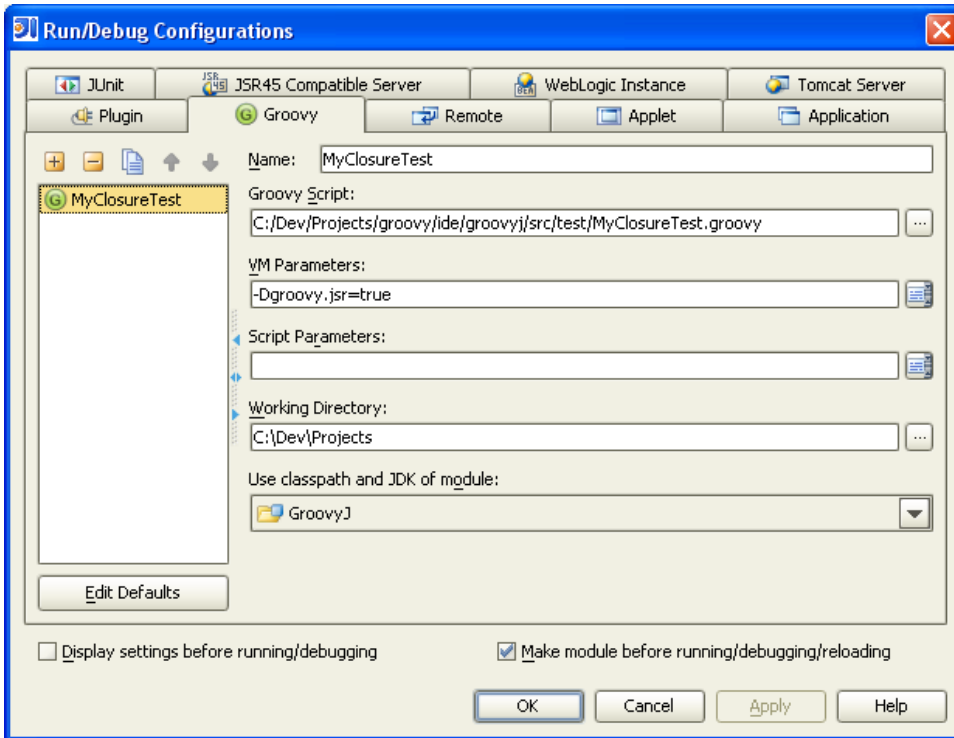

GROOVY-607 - Compilation

The compilation of Groovy scripts is seamlessly integrated into IDEA's build subsystem so that invoking any of the **Rebuild Project**, **Make Project**, **Make Module**, or **Compile** actions will also compile scripts found under the *source and test folders*.

It is also possible to compile individual Groovy scripts, that is, files ending in **.groovy**, **.gvy**, **.gy**, **.gsh**, as illustrated below:

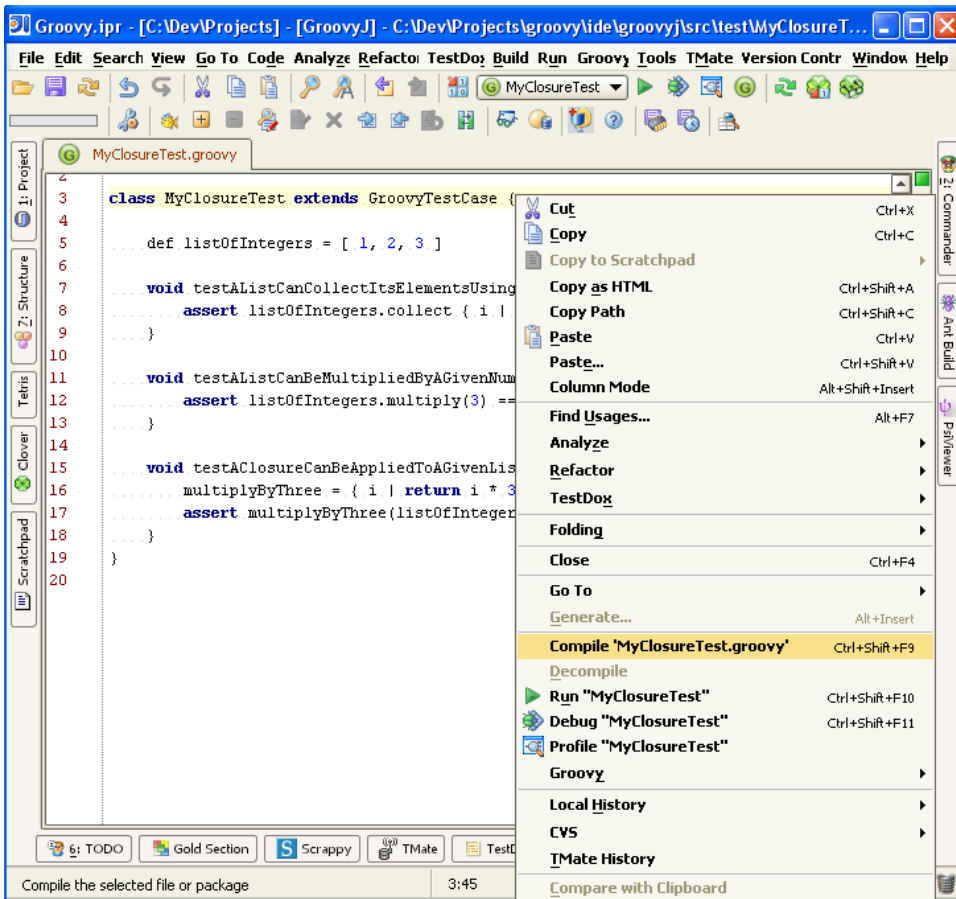

Compilation results are displayed in the *Messages* window where double-clicking on errors and warnings jumps straight to the corresponding offending line of code:

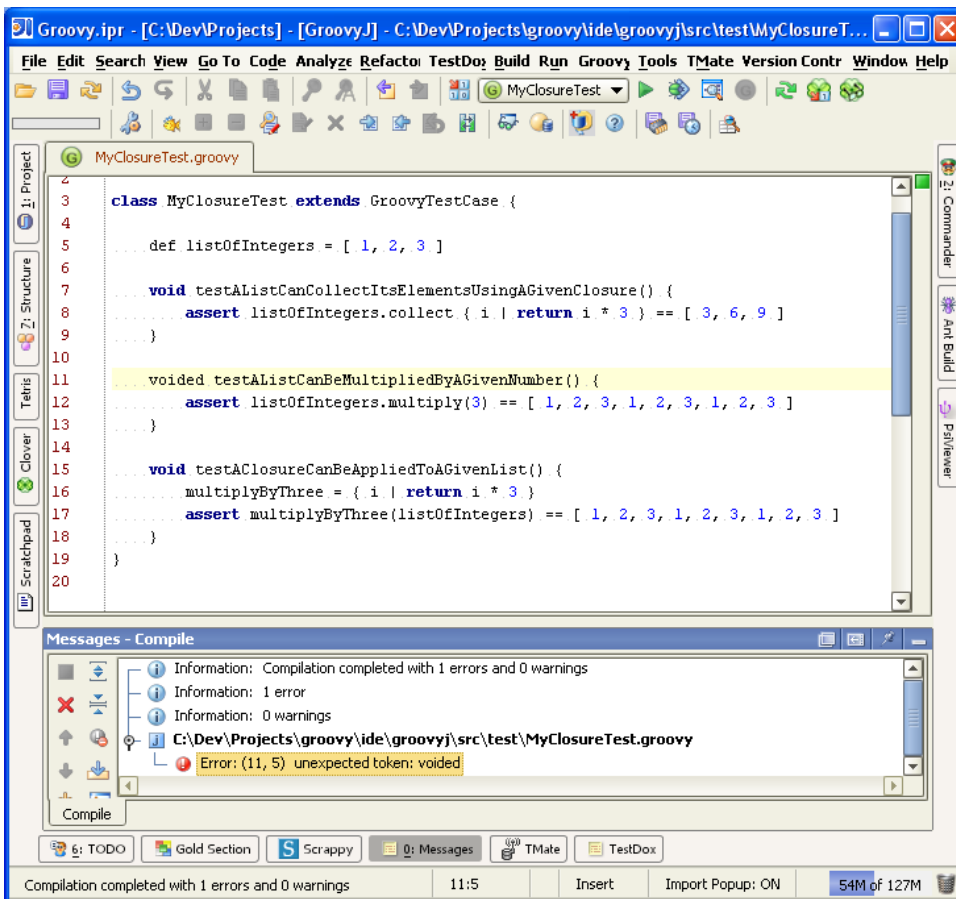

Planned Features

For a list of planned (or wished) features, please look at the [GroovyJ Features and Wish List](#) page.

IDEA Open API

This page last changed on Sep 24, 2006 by [paulk_asert](#).

Useful Links

This page should be used for sharing the many IDEA Open API tips and tricks that we will encounter along the road.

- The latest plug-in development kit can be found on the [EAP page](#) and is called **ideaXXXX-dev.zip**.
- [PsiViewer](#) is a very useful plug-in that renders the IDEA Program Structure Interface (PSI) tree representing the file being edited.
- IntelliJ IDEA forums are a source of valuable information:
 - [Open API forum](#)
 - [Plugins forum](#)
- Richard Osbaldeston shares some [plug-in authoring tips](#).

IntelliJ IDEA Plugin (JetBrains Edition)

This page last changed on Dec 09, 2007 by [glaforge](#).

JetBrains, the makers of the award winning IntelliJ IDEA Java IDE are working on a Groovy and Grails plugins. The plugin is currently in the making and the official plugin homepage can be found on [JetBrains wiki](#).

Download & Installation

The plugin requires IntelliJ IDEA 7 to function. Install the plugin via the IDEA plugin manager (you can find it listed as "JetGroovy"). After installing the plugin via the plugin manager, you will have to restart idea and then configure the plugin via the settings panel so that the plugin knows where to find your Groovy and (optionally) Grails installation directories.

Features

The JetGroovy plugin provides a rich set of features for both Groovy and Grails development. Here, we're listing the main features, but you can find out more on [JetGroovy Groovy features page](#) and the [JetGroovy Grails features page](#).

Editing

- Syntax highlighting
- Error highlighting
 - Unresolved classes marked as errors
 - Unresolved unqualified properties marked as warnings
 - Incompatible types assignments marked as warnings
 - Inapplicable method calls marked as warnings
- Code folding
- Code formatter
- Comments and "To Do" view support
- "add missing import" intention
- Various refactorings
 - move, rename variables, etc

Execution, Debugging & Compilation

- Debugging support (setting breakpoints, view stack)
- GDK configuration
- Grails configuration
- Run configuration for Groovy scripts
- Make or rebuild java+groovy project entire

Code Completion

- context sensitive keyword completion
- Completion of methods, fields, classes
 - Completion makes use of type inference
 - Default methods completed
 - Swing builder methods are completed, swing properties are completed in method argument list
- Resolve
 - Resolve groovy to groovy classes, methods, fields
 - Resolve groovy to java classes, methods, fields
 - Resolve java to groovy classes, methods, fields

Surround with (Alt+Ctrl+T)

- if () {} / else {}
- while () {}
- try / catch / finally
- closure {}
- (Type) expr

Introduce variable (Alt+Ctrl+V)

- Introduce variable
- Offer the default type and variable name

Structure view

Shows

- classes
- methods
- fields
found in groovy file

File structure (Ctrl+F12)

- The popup window contains classes, methods, fields.

Find usage (Alt+F7)

- Implements groovy classes search

Class search (Ctrl+N)

- Searches class by prefix of class groovy name

Grails

- Grails SDK configuration
- Grails controller, view, domain class, job, script, service, taglib creation
- Grails generators are built in; output to console

Wish list

A user wish list is available:

- [Wish List \(JetBrains Edition\)](#)

Wish List (JetBrains Edition)

This page last changed on Apr 27, 2007 by [mittie](#).

Please add your own entries, and increment the vote count for features that interest you. **IMPORTANT:** Please try and consider your suggestions from an IntelliJ design and terminology viewpoint rather than trying to insert ideas that are concepts from other IDEs that don't make sense in the IDEA world.

Debugging

- Full debugging support, including setting breakpoints, watch variables, view stack, view vars in scope, etc.
- Support for transitioning from Java to Groovy and vice versa.
- Ability to filter stack traces to show only Groovy classes.
- Ability to debug scripts in addition to classes.
- Allow Alt-F8 to evaluate Groovy expressions

Editing

- Code Formatting (as currently supported for Java code)
- Auto insertion of packages and imports (as currently supported for Java code)
- Code Completion (including support for Builders)
- Intentions support
- Syntax Highlighting (including the ability to color Groovy specific constructs differently)

Execution & Testing

- Ability to run Groovy based tests in a similar fashion to standard JUnit tests, with matching green/red runner results view.
- The ability to specify Groovy Run/Debug configurations for scripts and classes. (Scripts shows in the current editor should not require the developer to setup a run/debug config and should be executable via the standard shift-F10/F9 hotkeys.)
- Gant integration (from an editing perspective this is covered by builder support but it would be nice to have a Gant tab just like there is an Ant tab in IDEA).
- Allow starting the GroovyConsole with the current project's classpath being available
- Groovy scratchpad (interactive execution of Groovy code like in the GroovyConsole but with Idea's editor support)

Grails

Currently, Grails suggestions are being collected in a non-IDE specific [location](#).

Misc

- Groovy classes should appear in the "Go To Class" dialogue (CTRL-N). Groovy classes in the list should be discernible from Java classes by a unique icon.
- Other "Go To" support like Java code, eg, CTRL-B or CTRL-click to jump to a class definition
- Find All References

- Type Hierarchy
- Groovy Search
- Show javadoc
- Ability to specify Groovy specific code style
- Cross compiler allowing to reference Groovy classes from Java and Java classes from Groovy
- Per-directory control over which Groovy source trees should be compiled and which should not; this is especially important for Grails where compiling the Groovy code under project/grails-app can interfere with the application, whereas the code under src/groovy *is* compiled
- The ability to register Groovy SDKs just like you can with Java so you can keep different versions of Groovy available for testing at the same time and be able to easily switch between them.

Refactoring

- Rename/move class
- Rename method/variables
- Extract Method
- Extract Variable
- Inline method/variable
- New Groovy Refactoring: extract conditional to closure

```
if (a & b) {...}
```

becomes

```
Closure cond = { a & b }
if (cond()) {...}
```

- New Groovy Refactoring: extract local closure

```
statement*
```

becomes

```
Closure localvar = { statements* }
localvar()
```

Templating

- Live Templates support

JEdit Plugin

This page last changed on Jun 02, 2007 by thebugslayer@gmail.com.

To use Groovy from inside jEdit download this

[plugin](#)

. You'll need a fairly recent jEdit distribution.

Right now BSF isn't yet released with inbuilt Groovy support so you have to add the following code to the startup script in

```
<jedit.home>/startup/startup.bsh
```

You can also add a startup.bsh script into your home directory at

```
<user.settings.home>/jedit/startup/startup.bsh
```

```
org.apache.bsf.BSFManager.registerScriptingEngine(  
"groovy", "org.codehaus.groovy.bsf.GroovyEngine", new String[] {"groovy", "gv"}  
);
```

Also you'll need to copy the groovy-all-1.0-jsr-XXXX.jar file into the jedit/jars directory.

Restart jEdit.

Open SuperScript dockable from Plugins Menu or Dockable area and choose "groovy" from the languages dropdown.

To test if groovy works fine or not, just try running some expression in the textbox or open some groovy script in jEdit and try "Executing Script".

Alternative Groovy mode

Oliver Rutherford has developed a Groovy mode for jEdit...

<http://www.rutherford.net/jEdit/modes/groovy.xml>

~/jedit/catalog entry:

```
<MODE NAME="groovy" FILE="groovy.xml"  
FILE_NAME_GLOB="*.{groovy,grv}"/>
```

The Groovy mode for jEdit is in the SVN since July, 9th 2004.

It is included in standard jEdit setup.

In order to know if you have this mode, check that the file <jEdit_Home>/modes/groovy.xml exists.

Console Commando Plugin

Instructions:

1. Install Console plugin in jEdit.
2. Copy the attachment on this wiki: groovy.xml into your \$HOME/.jedit/console/commando/groovy.xml (NOTE: I hardcoded my groovy path. Change it if it doesn't match yours.)
3. jEdit Menu: Plugins>Console>Regen menu.
4. jEdit Menu: Plugins>Plugin Options..., On left pick Console>Compile&Run, Then select groovy file type and set your compiler/interpreter to "groovy" selection.

Now you may open up any groovy script and Run Commando..., Default F5 will re-run the last command.

NetBeans Plugin

This page last changed on Nov 22, 2007 by [martin.adamek](#).

Groovy is supported in NetBeans via modules available at Development Update Center. <http://coyote.dev.java.net> project is no longer supported, but most of its functionality is now in this new plugin.

Plugins for Groovy and Grails are currently under development (started in Nov 2007). Here is an overview of what you can currently do with Groovy and Grails in NetBeans IDE 6.0, as well as instructions for getting started.

How To Get Started

In [development build](#) of NetBeans you can go to Tools->Plugins and search for 'groovy'. Then select found item and press Install.

How To Submit Issues

Submit issues under top-level Component 'groovy' in [NetBeans Issuezilla](#).

Where Are The Open Tasks?

See the [Development Page](#).

What You Can Already Do With Our Plugins

Don't forget to set Groovy and Grails homes in Groovy options category
Cannot resolve external resource into attachment.

Project wizards for Groovy and Grails
Cannot resolve external resource into attachment.

Grails project support (open existing or create new, wizards for some Grails components, run project)
Cannot resolve external resource into attachment.

Groovy project support (create, run project, execute script)
Cannot resolve external resource into attachment.

Groovy editor (basic coloring, formatting, bracket completion)
Cannot resolve external resource into attachment.

GSP editor (coloring, highlighting of GSP tags, expressions and scriptlets)
Cannot resolve external resource into attachment.

We welcome contributors, let us know if you're interested in extending the Groovy support in NetBeans.

Oracle JDeveloper Plugin

This page last changed on Feb 06, 2008 by [paulk_asert](#).

Oracle JDeveloper is a free integrated development environment with end-to-end support for modeling, developing, debugging, optimizing, and deploying Java applications and Web services. Oracle JDeveloper can be downloaded from [Oracle Website](#).

 The plugin is work in progress.

Installation

The Groovy extension is available through the **Help->Check for Updates** menu of JDeveloper. The Groovy plugin is registered in the "Open Source and Partners Extensions" update center.

- Go to: **Help -> Check for Update**
- Click **Next**
- Select the **Open Source and Partners Extensions** repository and click **Next**
- Select the features to install upgrade by selecting the Groovy check box and press **Next**
- Select if you want to make this extension available for All the user or only the current one.

This will automatically download the extension and ask you to restart JDeveloper. Once you restart JDeveloper the extension will be installed. To verify the installation visit the **Tools->Preferences->Extensions** menu and look for the Groovy extension entry.

Groovy Library

The extension adds a new library to JDeveloper with the JAR files of the Groovy 1.0 language. You can access this library definition through the **Tools->Manage Libraries** menu option. The Groovy library would be added to your project automatically when you create a new script. You can also add it to project manually.

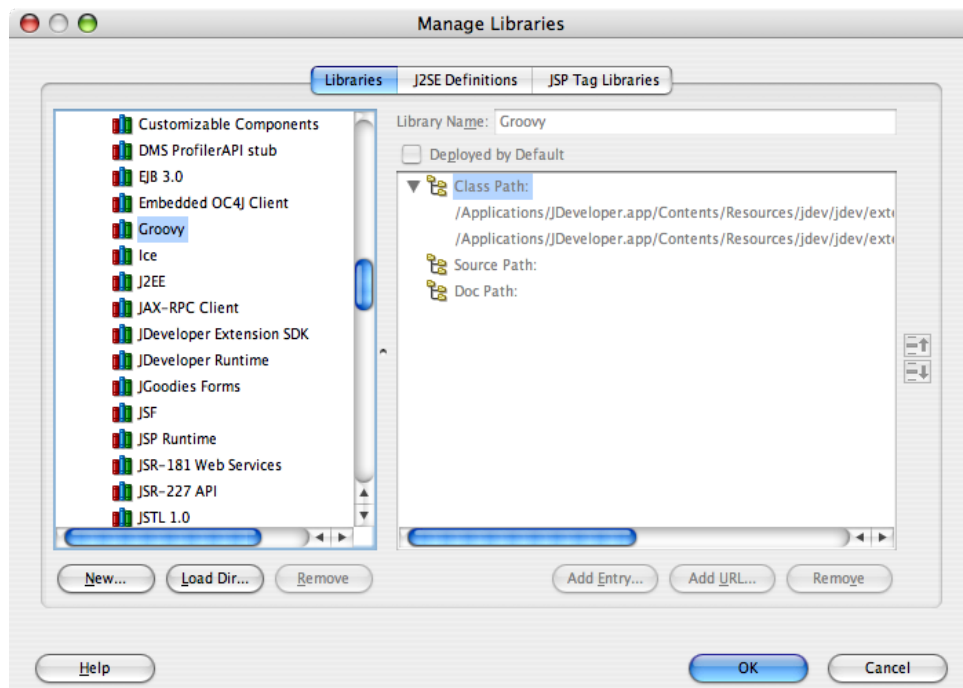

Groovy Script Creation Wizard

The Groovy extension adds a new wizard to JDeveloper that allows you to create scripts file and also automatically configures the project to include the Groovy library. Once the script is created you can start editing and running it from JDeveloper.

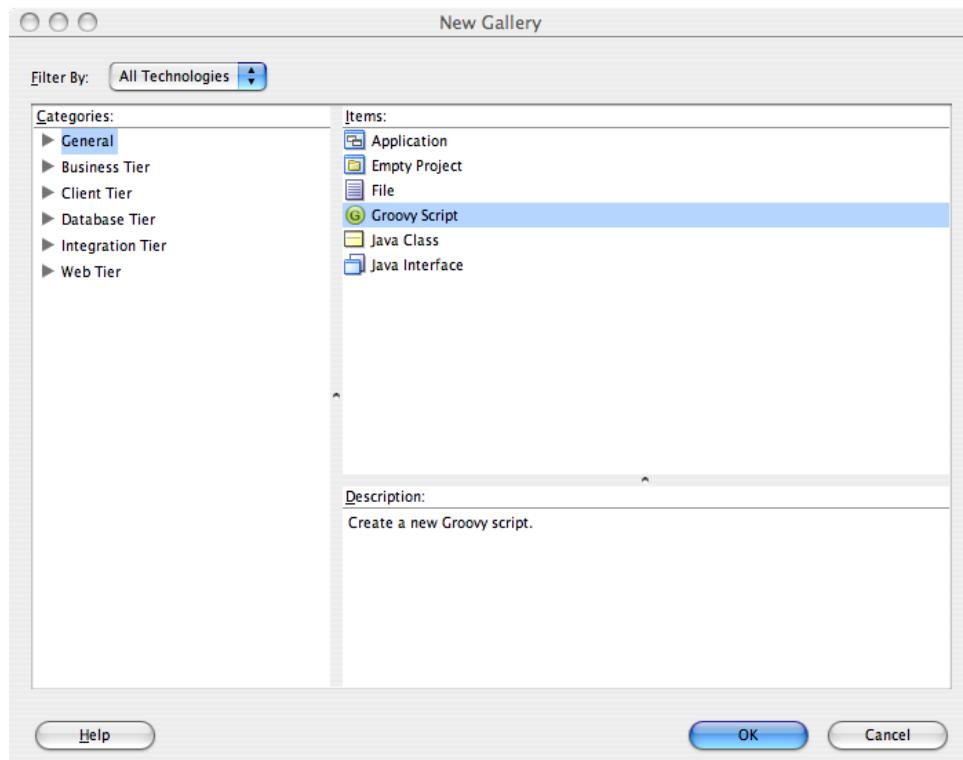

Other Plugins

This page last changed on Apr 20, 2008 by jimruley@gmail.com.

TextMate (Mac OS X Only)

There is a Groovy plug-in for the popular TextMate editor on Mac OS X [here](#).

XCode (Mac OS X only)

<http://www.vengefulcow.com/groovy/>

SubEthaEdit 1.x

Brian McCallister has created a plugin for [SubEthaEdit](#), which is [here](#).

SubEthaEdit 2.x

A new-format language "mode" for SubEthaEdit 2.x is available [here](#).

Vim

A [Vim](#) plugin is available [here](#) (written by Jim Ruley).

Vim provides Groovy syntax highlighting out of the box (syntax file created by Alessio Pace). The syntax file is also available [here](#).

TextPad 4

Guillaume Laforge wrote a syntax file for the TextPad text editor which can be downloaded [here](#). This file should be installed in the Samples subdirectory of your TextPad installation.

EditPlus

[Michal Szklanowski](#) contributed a syntax file for the [EditPlus](#) text editor which can be downloaded [here](#).

Emacs

Jeremy Rayner has written a groovy-mode for emacs, details of which can be found on the [Emacs Plugin](#) page.

Russel Winder has started an alternative to Jeremy's based on CC Mode (Jeremy's was reworking of ruby-mode). Also Stuart Clayman has created a Groovy execution mode. See the [Emacs Plugin](#) page for details.

UltraEdit

Find more info on the [UltraEdit Plugin](#) page.

PS PAD

Syntax file for [Ps PAD](#) is available [here](#) by Marc DeXeT.

Enscript

[State file](#) for [GNU enscript](#). It needs to be installed alongside the other enscript state files, for example in `/usr/share/enscript/hl/` on SUSE linux.

Highlight

[Language definition file](#) for [Highlight](#).

Crimson Editor

Syntax files for [Crimson Editor](#) are available [here](#) (written by Jim Ruley).

Emacs Plugin

This page last changed on Sep 24, 2006 by [paulk_asert](#).

groovy-mode for (X)Emacs

Jeremy Rayner created a groovy-mode for (X)Emacs, which has syntax highlighting, recognises curly brace indentation (just use the tab key), and doesn't panic about optional semicolons. He tested it in Emacs on Mac OSX 10.3, and others use it and it isn't painful.

Russel Winder has begun an alternative version of groovy-mode as a derived mode in CC Mode. Currently, this has some problems with indenting when semicolons are not used as statement terminators but this is being actively worked on -- CC Mode has support for languages like Awk and Groovy that do not require semicolons.

Stuart Clayman has created a "Groovy inferior mode" (nothing inferior about Stuart's code but this is the jargon for an interpreter execution mode) which allows groovysh to be run from within (X)Emacs.

Download

(NB Links go to the latest versions in Subversion)

Download Jeremy's [groovy-mode.el](#) file and place it somewhere like (on OSX)
/usr/share/emacs/site-lisp/groovy-mode.el
your mileage may vary...

Download Russel's [groovy-mode.el](#) and place it in your (X)Emacs' load path.

NB As both Jeremy's and Russel's are called groovy-mode you have to have one or the other, you can't have both.

Download Stuart's [inf-groovy.el](#) and place it in your (X)Emacs load path.

.emacs

add the following lines to your ~/.emacs file:

```
;;; turn on syntax highlighting
(global-font-lock-mode 1)

;;; use groovy-mode when file ends in .groovy or has #!/bin/groovy at start
(autoload 'groovy-mode "groovy-mode" "Groovy editing mode." t)
(add-to-list 'auto-mode-alist '(("\\.groovy$" . groovy-mode))
(add-to-list 'interpreter-mode-alist '("groovy" . groovy-mode))
```

TODO

Comments regarding Jeremy's mode:

- check this works in xemacs, and put your results in this page (anyone can edit 😊)
 - The Groovy mode appears to work in XEmacs, but setting the global-font-lock-mode gets a message and was commented. Thanks!
 - I concur that groovy mode works in XEmacs and that the global-font-lock-mode needs to be commented. The indent level default was changed from 4 to 2.
- sort out the comment blocks, as it is currently based on ruby, where the symbol # currently denotes the start of a comment, maybe this can be cribbed from java-mode...
- at the moment you have to hit tab to do indents, I'm sure emacs can do this automatically on carriage return...

Comments regarding Russel's mode:

- Get optional semicolons working properly.

- Get the font-lock colouring a bit more consistent.

Disclaimers

- Jeremy's mode is based upon ruby-mode in ruby stable snapshot - Wed Nov 24 04:01:06 JST 2004. This is just a quick hack of a groovy-mode, so if it's broken for you, fix it and share with the world.
- Russel's mode has "issues" when used with CC Mode 5.31 where groovy-mode is not compiled and CC Mode is.

jez.

<http://javanicus.com/blog2>

Russel

<http://www.russel.org.uk>

UltraEdit Plugin

This page last changed on Jun 29, 2006 by [paulk_asert](#).

Well, the name 'Plugin' is a bit too much, but I wanted to stick to the naming convention...

Ultra Edit

UltraEdit is a nice little text editor when working on Windows. It is very much suited to handle all kinds of resource files and some little scripts, when starting your IDE just takes too long.

You can get it from <http://www.ultraedit.com/>

UltraEdit is not free but fairly inexpensive. One can work with the evaluation license forever, but warnings get more and more annoying then.

Running Groovy scripts

The first nice thing is to edit and run any groovy script from inside the editor. When doing so and getting a stacktrace, it is added to an output list that is click-aware. In the line you click, UltraEdit tries to find a filename and a line/column position and opens the editor at that position.

To make this happen, go to Advanced -> Tool Configuration and enter the following:

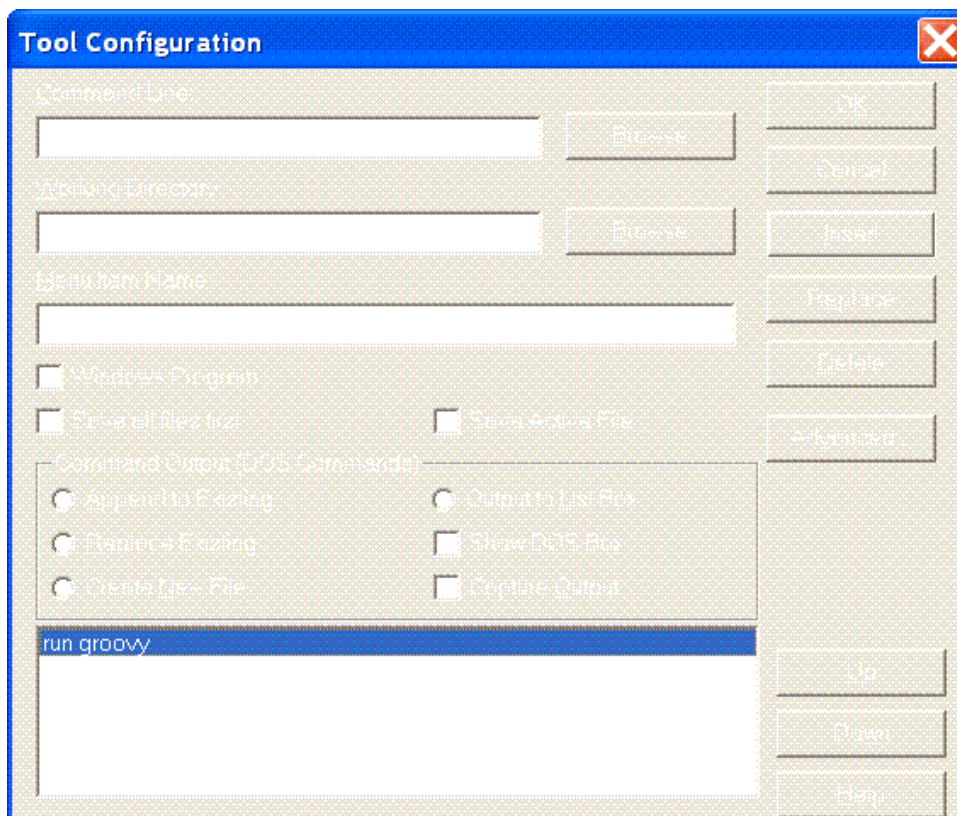

After that, you can run your active Groovy script with Ctrl-Shift-0.

Groovy awareness

UltraEdit is aware of those languages that are described in %INSTALL_DIR%\WORDFILE.txt. Add to that file what you find [here](#) . UltraEdit assigns numbers to its known languages (up to 20 may be defined). Groovy is numbered as 12 in the above file. If that would conflict with an existing entry, you can change that by editing the first line that reads /L12.

With that language support, Groovy code now looks like

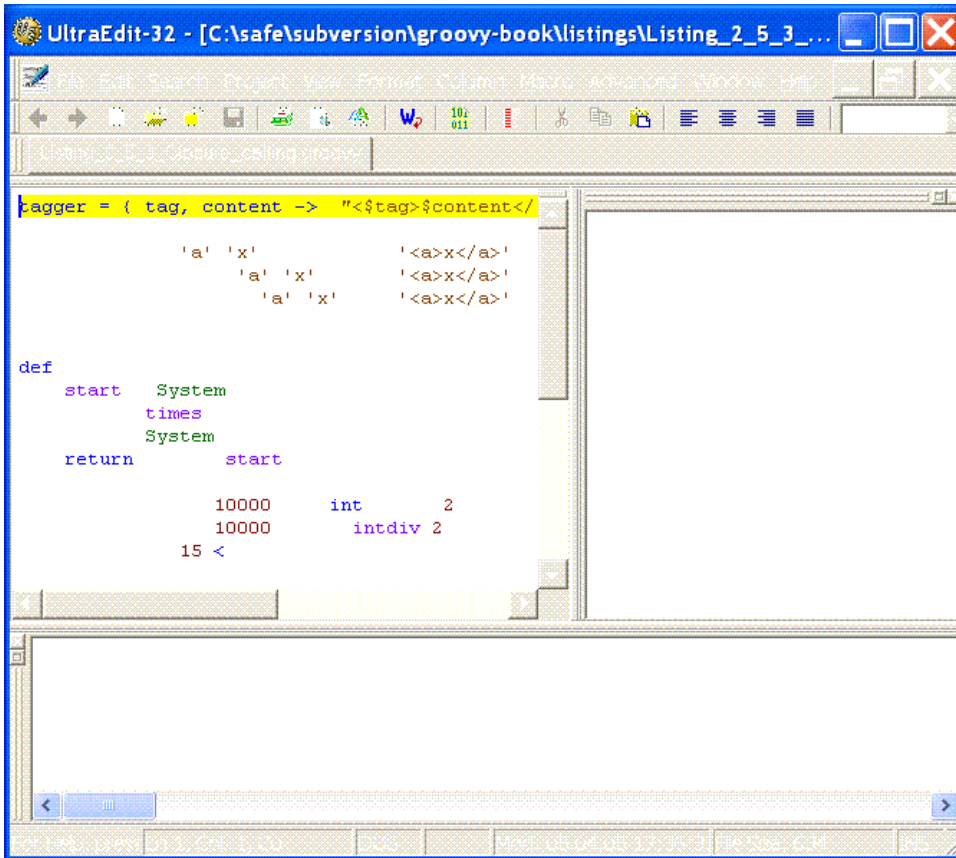

Below the editor is the output window and right of it is a *function list*, that shows interesting lines of the file. The current implementation shows class and method definitions. They are clickable for easy navigation.

Other features

Hitting Ctrl-Space in UltraEdit will cause it to try some text-based code completion. It is surprising how helpful such a simple functionality can be.

UE will try to smart-indent your code while typing.

All the usual other stuff like

- moving selection with the mouse,
- indent/unindent with tab/shift-tab on selections,
- smart replacements with regular expressions in selection/current file/all open files/recursively through subdirs
- file type and encoding conversions
- hex view
- column mode
- smart selection on double click
- macros
- file compare
- and - above all - **starts amazingly quickly**

Have fun.

- Mittie

The Groovy TextMate Bundle

This page contains the TextMate bundle files that add Groovy & Grails support to the TextMate text editor for Mac OS X. They were originally written by Graeme Rocher (Grails project lead) and are made available as is.

DOWNLOAD

from [here](#)

However, the above link is not the latest code as the Groovy TextMate bundle is now hosted and maintained within the Macromates SVN repository. The details of which can be found here: <http://macromates.com/wiki/Main/SubversionCheckout>

INSTALLATION

Copy the Groovy and Grails bundle files to `~/Library/Application Support/TextMate/Bundles` and start TextMate

USAGE

The bundles add Groovy and GSP support to files ending with `.groovy` and `.gsp`. There is syntax highlighting and code completion with snippets. All of the completions can be found in Bundles -> Groovy and Bundles -> Grails.

It is useful to look at these menus as a lot of the Groovy API is explore-able from there.

Some useful tips:

- type "to" and hit TAB for type conversion by method call
- type "as" and hit TAB for type conversion by coercion
- type "with" and hit TAB for i/o stuff
- typing `ea`, `eawi`, `eal`, `eaf`, `eab`, `eam` and hitting TAB do things like `each`, `eachWithIndex`, `eachFile` and `so on`
- type "static" and hit TAB for various options for statics
- type "cla" and hit TAB for class definition templates
- typing ":" and hitting TAB creates key/value hash pair
- Use `^ H` to access JavaDoc help given you have them installed
- Use `^ ENTER` to create new methods
- Use `Apple + Run` to execute the current file
- Select some text and use `ALT + APPLE + Run` to execute the snippet

Remember after you have hit TAB you can often TAG through the code the template generates to modify each changeable value.

Version History

0.2

- Fixed Multi-line Groovy string highlighting
- Added for snippet with key "for" + TAB
- Added Grails bundle

0.1

- Initial revision

GantMate

GantMate allows you to run [Gant](#) tasks for your project from within TextMate. It is currently available from here for testing purposes but will be integrated into the Groovy bundle eventually.

[GantMate.zip](#)

[Run Gant Task.tmCommand.zip](#)

Installation

Grab the two zips from above. Unzip GantMate.zip and place in `~/Library/Application Support/TextMate/Bundles/Groovy.tmbundle/Support/`. Unzip Run Gant Task.tmCommand.zip and double click to install. It should install itself in the Groovy bundle.

Usage

The default key mapping is control+shift+g and is scoped to Groovy source files.

Modules

This page last changed on Nov 28, 2007 by [user57](#).

The following modules and contributions are currently available:

- [COM Scripting](#) — script Windows ActiveX and COM components with Groovy
- [Gant](#)
- [GFreeMarker](#) — an integration of the FreeMarker template engine for Groovy
- [Google Data Support](#) — makes using the Google Data APIs easier from within Groovy
- [Gram](#) — a simple xdoclet-like tool for processing doclet tags or Java 5 annotations
- [GraphicsBuilder](#) — GraphicsBuilder is a Groovy builder for Java 2D
- [Grapplet](#)
- [Griffon](#) — Dekstop Enhancements for Groovy
- [Groosh](#) — Provides a shell-like capability for handling external processes.
- [Groovy Jabber-RPC](#) — allows you to make XML-RPC calls using the Jabber protocol
- [Groovy Monkey](#) — is a dynamic scripting tool for the Eclipse Platform
- [Groovy SOAP](#) — create a SOAP server and make calls to remote SOAP servers using Groovy
- [GroovyLab](#) — Provides a domain specific language (DSL) for math engineering (matlab-like syntax).
- [GroovyRestlet](#) — Groovy DSL for constructing Restlet application
- [GroovySWT](#) — a wrapper around SWT, the eclipse Standard Widget Toolkit
- [GroovyWS](#) — GroovySOAP replacement that uses CXF and Java5 features
- [GSP](#) — means GroovyServer Pages, which is similar to JSP (JavaServer Pages)
- [GSQL](#) — supports easier access to databases using Groovy
- [JideBuilder](#) — JideBuilder is a Groovy builder for the open source [JIDE Common Layer](#)
- [Native Launcher](#) — a native program for launching groovy scripts
- [Windows NSIS-Installer](#) — a Windows-specific installer for Groovy
- [Windows Services](#) — framework for Groovy-based WinNT (Windows) Services
- [WingSBuilder](#) — WingsBuilder is a Groovy builder for the [wingS Framework](#)
- [XMLRPC](#) — allows you to create a local XML-RPC server and/or to make calls on remote XML-RPC servers

- [Grails](#) — a Groovy-based web framework inspired by Ruby on Rails
- [GORM](#) — the Grails Object-Relational Mapping persistence framework
- [GroovyPlugin](#) — A Groovy plugin for JSPWiki
- [Maven Plugin](#) — Integration of Groovy with [Maven](#)

COM Scripting

This page last changed on Feb 05, 2008 by [jasonsmith](#).

Introduction

Scriptom ([scriptom-1.5.4.zip](#)), an optional Groovy module originally developed by [Guillaume Laforge](#), combines the elegant "syntactical sugar" of Groovy with the power of the [Jacob library \(Java COM Bridge\)](#). The result is something that looks an awful lot like **Windows Scripting Host** (WSH) scripting with VBScript - only it's for **Java**. Once installed into Groovy, **Scriptom** allows you to script **ActiveX** or **COM** Windows components from Groovy.

What this means is that you can use Groovy to automate **Word** or **Excel** documents, control **Internet Explorer**, make your PC talk using the **Microsoft Speech API**, monitor processes with **WMI** (Windows Management Instrumentation), or browse the **Windows Registry** using **WShell** (among many, many other things). It is also a convenient way to talk to custom **VB6** or COM-enabled **Microsoft.NET** libraries (compare this to the administrative headaches of getting **Java** and **.NET** to talk using **Web Services** - it's a no brainer). All this without ever leaving the comfortable **Java** universe.

Of course, **Scriptom** can be used only on **Microsoft Windows**.

Scriptom is bundled into the [Groovy Windows-Installer](#), and the most current version can be downloaded from this page (see below). The codebase is considered stable and feature-complete. The **Jacob** project - **Scriptom**'s foundation - was started in 1999 and is being used in thousands of production applications worldwide. **Scriptom** is only a few years old, but it is already stable and mature because it is built on an existing, best-of-breed platform.

Scriptom gives you all the **COM**-scripting power of **Jacob**, only it is a lot easier. See [Getting Started with COM](#) for some tips to get you started.

The **Scriptom** team

- [Guillaume Laforge](#)
- Dierk Koenig
- Marc Guillemot
- [Jason Smith](#)

Requirements

The following are required to run **Scriptom**:

- **Groovy 1.5**
- **Java 1.5**
- **Windows** and **Java** for **x86** or **x64 (AMD64)** architectures. **Itanium (IA-64)** is not supported.

Installation

Download the project archive and extract the files.

-  [scriptom-1.5.4.zip](#) Build 11 (2/5/2008) - **Scriptom** JAR file, **Scriptom-1.5.4bX-32.dll**, **Scriptom-1.5.4bX-64.dll**, Java source code, ANT build script, examples, tests, utilities, and documentation.

Install the jar file and DLL file(s) into your project, and optionally install an update from Microsoft:

1. Add the **Scriptom** jar file (**scriptom-1.5.4bX-XX.jar**) into your Java classpath. It contains both **Scriptom** and **Jacob** class files, so you must not include **jacob.jar**.



Scriptom contains a full (current) version of the **Jacob** library. If you are using **Jacob** directly elsewhere in your project, remove all references to it and use the version built in to **Scriptom**.

- Copy both **Scriptom-1.5.4bX-XX.dll** files to somewhere on your **java.library.path**. (usually somewhere on the system 'PATH').

 The **Scriptom DLL** naming convention allows multiple versions of **Scriptom** to run on the same machine. However, you can only run a single version of **Scriptom JAR** in any given project.

- To avoid the dreaded **java.lang.UnsatisfiedLinkError**, download and install one of the following updates from Microsoft: [Microsoft Visual C++ 2005 SP1 Redistributable Package \(x86\)](#) or [Microsoft Visual C++ 2005 SP1 Redistributable Package \(x64\)](#). **Scriptom** doesn't support the **IA-64 (Itanium)** architecture at this time, mainly due to lack of interest. If you are wondering about the different processor architectures, check out the [x86-64 wiki](#). It is usually necessary to install these updates on **Windows Server 2003** and **Windows 2000**, and we've found that it may also be necessary for **Windows XP** and even **Vista**.

 A project can only use one version of **Scriptom** at a time. If you have installed **Groovy** using the **Groovy Windows Installer**, you must remove any versions of **Scriptom JAR** files or replace them with the latest version. A version of **Scriptom** is installed as part of the **Groovy Windows Installer** installation.

Scriptom 1.5 is not supported for **Groovy 1.0** and earlier (**Scriptom 1.2** is still available).

Building from Source

The project archive contains all the **Scriptom** source files, Java source files from **Jacob**, and an ANT build script. To save space, the Groovy JAR files have been omitted from the archive. For a successful compilation, Groovy JAR files must be added to the **project/lib** folder.

The latest build requires **Groovy 1.5**.

Scriptom includes source files from **Jacob** version **1.14**. You don't need to download it from the **Jacob** project on **SourceForge.net**.

To build the project, run **project/build/make.bat**.

The build process requires **Java 1.5** or higher (**Java 1.6** recommended) and **ANT 1.6.5** or better.

Changes from Scriptom 1.2

Scriptom 1.5 is a substantial upgrade to previous versions of **Scriptom**, and *is not backward compatible*. We hope you will agree that it is worth a little code rework to get all these great new features!

- Provides simplified helper methods for dealing with COM apartment threading models.
- **ActiveXProxy** name changed to **ActiveXObject** to match WSH convention.
- **VariantProxy** no longer exists (the functionality was refactored into **ActiveXObject**).
- Variant values are converted to and from the equivalent Java type; no more calling **.value** on everything!
- Supports COM event callbacks using closures (this is still a work in progress, but usable as is).
- Supports indexed properties, including multiple indexes.
- Supports typed, multi-dimensional SafeArrays.
- Supports pass-byref (in/out) values, both in method calls and event handler callbacks.
- Supports COM enumerable types (so you can use **.each**, for example).
- Supports missing arguments (for optional parameters) in method/property calls and events.
- Includes constant definitions for several popular Windows applications, derived from these type libraries (see JavaDoc):
 - Microsoft Office 2003 (works with other versions as well)

- Word 2003
- Excel 2003
- Outlook 2003
- Access 2003
- PowerPoint 2003
- Microsoft Internet Explorer 6 (works with other versions as well)
- Microsoft Scripting (i.e., FileSystemObject)
- Microsoft Speech API
- Windows Scripting Host (WSH)
- WbemScripting (WMI - Windows Management Instrumentation)
- Supports the latest features from **Jacob 1.14**, including new support for the **Decimal** data type and 64-bit integers.

Migrating from Previous Versions of Scriptom

Scriptom 1.5 is not backward compatible with previous versions of **Scriptom**. To get your scripts running again, do this:

- Change all references to **ActiveXProxy** into **ActiveXObject**.
- Wrap any code that references an **ActiveXObject** in **Scriptom.inApartment { ... }**, which replaces the way Scriptom previously handled COM threading.
- Remove all references to **.value** property references.
- Remove any statically typed references to **VariantProxy**.
- Support for COM events is greatly improved in this version - and also greatly changed. Refer to the **Events** section below for more information.

Quick Start

Let's say you want an application that talks. Pure Java implementations aside (this is, after all, a Groovy/COM tutorial), and ignoring the fact that the default voice on pre-Vista machines sounds like [Dr. Zoidberg](#) with a sinus infection, you could use the **Microsoft Speech API (SAPI)** to get the job done.

You start by creating an **ActiveXObject** with the prog-id for **SpVoice**. Now you can call any of the methods it supports. By default, **SpVoice** will block until it is done speaking, but we're going to have it speak asynchronously and wait until it is done.

```
import org.codehaus.groovy.scriptom.*
import org.codehaus.groovy.scriptom.tlb.sapi.SpeechVoiceSpeakFlags;
import org.codehaus.groovy.scriptom.tlb.sapi.SpeechRunState;

//Definitive proof that you CAN talk and chew gum at the same time.
Scriptom.inApartment
{
def voice = new ActiveXObject('SAPI.SpVoice')
voice.Speak 'GROOVY and SCRIPT um make com automation simple, fun, and groovy, man!',
SpeechVoiceSpeakFlags.SVSFlagsAsync
while(voice.Status.RunningState != SpeechRunState.SRSEDone)
{
println 'Chew gum...'
sleep 1000
}
}
println 'Speaker is done.'
```

If you have scripted COM before, you are probably used to using "magic numbers" throughout your code in place of COM constants. In this code sample, we're using fully-qualified constants instead.

Scriptom includes fully JavaDoc'd constant and interface definitions from a number of commonly used type-libraries, and you can even create your own. The source code for generating COM type library

definitions for **Groovy** is written in **Groovy** 😊, and it's included in the project. It may not seem like a big deal to replace a couple of numbers, but it will be a lot easier in 10 years to find relevant information on **SpeechVoiceSpeakFlags.SVSFlagsAsync** than on the number **1** (Google returns a little more than

9 billion hits for the number '1', and about 1,000 for 'SpeechVoiceSpeakFlags.SVSFlagsAsync,' including hits on this paragraph). And besides, the code reads better.

Speaking of interfaces, it turns out that **SpVoice** supports several. You can test an **ActiveXObject** to see if it supports a given interface using **.supportsInterface**, and you can cast an **ActiveXObject** to a given interface using **.toInterface**.

This next example displays the COM interfaces that **SpVoice** supports (within the **SAPI** library only):

```
import org.codehaus.groovy.scriptom.*;
import org.codehaus.groovy.scriptom.tlb.sapi.SpeechLib;

Scriptom.inApartment
{
def voice = new ActiveXObject('SAPI.SpVoice')
SpeechLib.interfaces.each {name, iid -> if(voice.supportsInterface(iid)) println "SpeechLib.$name - $iid"}
}
```

Programmer's Guide

The Least You Need to Know about COM	how not to crash the JVM or lock your process
COM Data Types in Scriptom	supported types and conversions in Java, VB6, and VB.NET
COM Methods and Properties in Scriptom	calling COM methods and properties from Groovy
Passing Values by Reference (in-out)	how to let methods change the value of passed-in arguments
COM Events	support for COM events
All About Arrays	UNDER CONSTRUCTION

Examples

Here is a simple example that uses the Microsoft **ScriptControl** to evaluate a JScript expression. This is a very indirect way to add 2 and 2.

```
import org.codehaus.groovy.scriptom.*

Scriptom.inApartment
{
def scriptControl = new ActiveXObject("ScriptControl")
scriptControl.Language = "JScript"
println scriptControl.Eval('2.0 + 2.0;')
}
```

There are many, many potential uses for **Scriptom** - far to many to try to maintain as part of this documentation. So we've included a whole slew of meaty examples in the project archive for you to play with. We'd like to encourage you to go look at those examples, run them, and modify them. And if you come up with an especially interesting example, let us know about it. We may even include it in a future release!

Some additional examples included with **Scriptom**:

- Automated writing to and reading from **Excel** spreadsheets. Includes COM events example.
- Navigation in **Internet Explorer**. Includes COM events example.
- Gathering information about processes and Windows NT services using **WMI**.
- Parsing a ***.msg** file with **Microsoft Outlook**.

Consuming **Visual Basic 6** (VB6) and **Visual Basic.NET** COM-enabled DLLs.

Articles

Articles about **COM scripting** in general, and **Scriptom** in particular.

Getting Started with COM	January 11, 2008	Tips for exploring COM libraries, finding documentation, etc.
Bridging the Gap Between Java and .NET with Groovy and Scriptom	December 3, 2007	Implement FIPS 140-1 compliant SHA-1 in Java with Groovy , Scriptom , and Visual Basic.NET .
Juixe TechKnow	August 8, 2006	A short Microsoft Outlook example.
Siebel	March 17th, 2008	Siebel "business component" programming

Post Scriptom

All known (unresolved) issues and feature requests are listed in the [Scriptom Jira](#) database.

Changes to each build are summarized in the [Change Log](#).

Recent builds of **Scriptom** can be found [here](#). Older versions are archived:

Scriptom-1.5.zip	Build 10. Bundled with the Groovy 1.5 Windows Installer . Requires Groovy 1.5 and Java 5 or better.
Scriptom 1.2	(also Scriptom 1.1 and Scriptom 1.0) Original version, and the one that is documented in Groovy in Action . Requires Groovy 1.0 or better and Java 1.4 or better.

All About Arrays

This page last changed on Nov 30, 2007 by [jasonsmith](#).

This article is under construction. You can find a good example of using an **org.codehaus.groovy.scriptom.SafeArray** in the **ExcelReport.groovy** example. This example demonstrates reading the value of a multi-cell **Range** as a 2-dimensional array (much faster than accessing the cells individually).

Change Log

This page last changed on Feb 05, 2008 by [jasonsmith](#).

Old **Scriptom** builds can be found [here](#).

Version	Date	Release	Jacob	Changes
1.5.4 b11	2/5/2008		1.14 final	Compiled against Groovy 1.5.4 . Uses Jacob 1.14 final . Exposes static methods on Scriptom object to allow Java code (using Jacob directly) to manage COM threading in coordination with Scriptom .
1.5.0 b10 Production Stable	12/10/2007	Groovy 1.5 Windows Installer, Groovy 1.5.1 Windows Installer	1.14M5 (modified)	Really fixed the bug introduced in Build 8 that broke Scriptom for Java 5 .
1.5.0 b9	12/8/2007		1.14M5	Fixed a bug introduced in Build 8 that broke Scriptom for Java 5 .
1.5.0 b8	12/7/2007		1.14M5	The release version of Groovy will be 1.5 . Scriptom's major and minor version numbers are being changed to match the supported version of Groovy . Added version info to manifest. Jar file is marked as "sealed." Recompiled to Groovy 1.1 rc3 and Jacob 1.14 M5 . Scriptom no longer uses the jacob.dll because of the potential for naming conflicts with other versions on the same machine. The 32-bit and 64-bit

				dlls have been renamed so that they can coexist on the same machine - with other versions as well. Scriptom will automatically find the correct version of the DLL for the JVM you are running.
2.0 b7	11/26/2007		1.14M5	Refactored EventArguments into standalone class, from an inner class of ActiveXObject (this change should not normally affect existing code). Fix for bugs due to BigDecimal-to-Decimal conversion overflows. Improved support for unsigned integer types. Uses Jacob 1.14 M5 .
2.0 b6 (Beta)	11/15/2007		1.14M3	Refactored org.codehaus.groovy.scripto packages to org.codehaus.groovy.scripto . Added type-library constants packages from Access 2003 and PowerPoint 2003 .
2.0 b5 (Beta)	11/14/2007		1.14M3	Moved from Jacob 1.14 M2 to Jacob 1.14 M3 . Uses new VT_I8 (64-bit signed integer) support. More unit testing.
2.0 b4 (Beta)	-	Groovy 1.1 rc2 Windows Installer	1.14M2	Fix for a NullPointerException that occurs only when debug tracing is turned on.

COM Data Types in Scriptom

This page last changed on Nov 22, 2007 by [jasonsmith](#).

The following table summarizes the equivalent types between **Scriptom** and COM (VB6/VBA/.NET).

Groovy/Java	VB6/VBA	VB.NET	Comments
null	Empty/Nothing	Empty/Nothing	
VariantNull	Null	???	VariantNull is not the same as Java null . Use Scriptom.NULL .
boolean	Boolean	Boolean	
byte	Byte	Byte/SByte	8-bit signed or unsigned integer. 0 to 255 in the COM library. -128 to 127 in Java . Conversion happens automatically.
short	Integer	Short	16-bit signed integer. -32,768 to 32,767.
(int)	-	UShort	16-bit unsigned integer. 0 to 65,535.
int	Long	Integer	32-bit signed integer. -2,147,483,648 to 2,147,483,647.
(long)	-	UInteger	32-bit unsigned integer. 0 to 4,294,967,295.
long	-	Long	64-bit signed integer. -9,223,372,036,854,775,808 to 9,223,372,036,854,775,807. 64-bit integers are not supported by COM in Windows Millenium or Windows 2000 and earlier.
(BigInteger)	-	ULong	64-bit unsigned integer. 0 to 18,446,744,073,709,551,615. 64-bit integers are not supported by COM in Windows Millenium or Windows 2000 and earlier.
float	Single	Single	Low-precision floating point. -3.402823E38 to -1.401298E-45 for negative values; 1.401298E-45 to 3.402823E38 for positive values.

double	Double	Double	High-precision floating point. The range of a Double is -1.79769313486231E308 to -4.94065645841247E-324 for negative values; 4.94065645841247E-324 to 1.79769313486232E308 for positive values.
BigDecimal	-	Decimal	High-precision fixed/ floating point (96 bits plus scaling), but without the large mantissa values supported by Double . Scriptom supports the Currency data type by converting to and from Decimal . The range of a Decimal is +/-79,228,162,514,264,337,593,543 for zero-scaled numbers (that is, numbers with no decimal places). For numbers with 28 decimal places, the range is +/-7.9228162514264337593543950. The smallest possible non-zero number is 0.00000000000000000000000000000001. BigDecimal values with greater precision than Decimal supports are automatically rounded.
BigDecimal	Currency	-	Numbers from -922,337,203,685,477.5808 to 922,337,203,685,477.5807, with a fixed decimal point. Scriptom handles Currency values internally as type Decimal .
Date	Date	Date	
String	String	String	
SafeArray	Array	Array	Scriptom supports multi-dimensional arrays for COM.
ActiveXObject	A COM-callable object	A COM-callable object	

Note that implicit type conversions are supported, so you could - for instance - pass a **float** to a method that expects a **double**. **COM** unsigned integer types are converted to the next largest Java signed equivalent integer type so that large positive values do not cause overflows.

 **CAUTION:** The default floating-point type in Groovy is **BigDecimal**, which gets converted to a **COM Decimal**. Although **Decimal** will work in the majority of cases, type conversions involving **Decimal** are inefficient compared to other numeric types. It is a good idea to explicitly coerce **Decimal** values to type **Double** or type **Integer**, whichever makes the most sense. Also note that **Decimal** does not handle the types of large mantissas that type **Double** can, but it supports more precision.

COM Events

This page last changed on Nov 30, 2007 by [jasonsmith](#).

Scriptom lets you subscribe to COM events on an **ActiveXObject** using the **.events** metaproperty. The event handler is a **Closure**. The arguments in the **Closure** are passed through an instance of **EventArguments**.

In this example, we're subscribing to the **Change** event of an Excel *Worksheet*. The **Change** event passes one argument - an Excel *Range*. In the context of this code, we're assuming that the *Range* object contains just one cell. In the general case, that would be a bad assumption. Once the event handler is defined this way, every change to a cell in the worksheet is going to print a line to standard out with the column, row, and new value.

```
worksheet.events.Change =
{args ->
def range = args[0]
println "\tEVENT Change (${range.Column},${range.Row}) = ${range.Value}"
}
```

Byref Arguments

As with other COM method types, events support passing values by reference. This is particularly important in light of the fact that events don't return a value. If you want to be able to send data back to whoever raised the event, you have to pass values back to the sender using byref arguments. Fortunately, this is easy to do using the **EventArguments** instance.

Take, for example, the following class written in **Visual Basic 2005**. When you call **RaisePassBooleanByref**, it will raise the **OnPassBooleanByref** event, by reference. This gives us an opportunity to change the value of the boolean in the event handler!

```
Option Explicit On
Option Strict On
Option Compare Binary

<Microsoft.VisualBasic.ComClass(> Public Class TestEvents
Public Event OnPassBooleanByref(ByRef Value As Boolean)

Public Function RaisePassBooleanByref(ByVal Value As Boolean) As Boolean
RaiseEvent OnPassBooleanByref(Value)
Return Value
End Function
End Class
```

In the following **Groovy** code, note how the return value changes after we define the event handler, which simply inverts the value of the first argument.

```
assert activeX.RaisePassBooleanByref(false) == false
activeX.events.OnPassBooleanByref = {args -> args[0] = !args[0]}
assert activeX.RaisePassBooleanByref(false) == true
```

Note that you may only change a value if it has been passed by reference. Otherwise you get an exception.

Event Handlers for Office and Internet Explorer

Back in the first example, I defined an event handler for an Excel *Worksheet*. There is another piece of information you need to make that example actually work. For many **COM** objects (and all true **ActiveX** objects), the underlying **COM** event handler is defined in a standard way that's easy to find and work with. However, for some **COM** objects, like those in **Microsoft Office** and **Internet Explorer**, there isn't enough information available for **Scriptom** to find the associated event interface. When this happens, you must manually define the prog-id of the object before you define any event handler. To help you out

as much as possible, these are available as constants in the **Scriptom** library for the **Office** suite and for **Internet Explorer**. Here is how you define a prog-id for an **ActiveXObject**.

```
import org.codehaus.groovy.scriptom.tlb.office.excel.Excel;

worksheet.events.useProgId Excel.progIds.Worksheet
//Equivalent to worksheet.events.useProgId 'Excel.Sheet'
```

Additionally, there are some objects in **Office** and other applications where the event interface exists, but it cannot be discovered, and the object does not have an associated prog-id. The Excel *Workbook* object is one example of this. We're hoping to address this limitation in a future version of **Scriptom**.

COM Methods and Properties in Scriptom

This page last changed on Feb 19, 2008 by [jasonsmith](#).

Method Syntax

The syntax for calling a method on an **ActiveXObject** is (mostly) the same as calling a method on any other Groovy object. The only caveat is that optional parameters may be omitted, or you can specify **Scriptom.MISSING** to indicate that an optional parameter is not defined.

```
def voice = new ActiveXObject('SAPI.SpVoice');
voice.Speak('It's all GROOVY, man!');
```

Property Syntax

In Groovy, which follows the JavaBean model, properties don't have indexes. There are lots of COM properties without indexes, and they work the same way. In the code example below, the **voice.Status** property returns an **ActiveXObject**, and the **RunningState** property returns an integer flag.

```
def voice = new ActiveXObject('SAPI.SpVoice')

voice.Speak 'GROOVY and SCRIPT um make com automation simple, fun, and groovy, man!',
SpeechVoiceSpeakFlags.SVSFlagsAsync
while(voice.Status.RunningState != SpeechRunState.SRSEDone)
{
  ...
}
```

COM also supports parameterized (or 'indexed') properties. Indexed COM properties look like an array, list, or a map. Properties may be read from or written to, but they do not represent standalone objects (that's **not** an array you are working with). In some cases, properties have more than one index. The following practical example sets the value of the first column in an Excel spreadsheet to a date value (alternately, a Java **Date** could have been used).

```
worksheet.Cells.Item[row+1,1] = "$row/1/2007"
```

Yep, that's a property!

Maybe We Made It too Flexible?

Methods and a property getters (both non-indexed and indexed) are pretty much the same thing, and in most cases, they are interchangeable. So the following two lines of code do the same thing:

```
println worksheet.Cells.Item[row+1,1]
println worksheet.Cells.Item(row+1,1)
```

Indexed properties don't work if all the parameters are optional. This doesn't normally happen in the real world (why would you do that?), but it is possible. To support this unlikely scenario, there is an alternate syntax for accessing properties as methods:

- To get a property value, simply call it as a method. Alternately (to match *setter* syntax), you can prefix the property name with **_get**.

To set a property value, prefix the property name with **_set** or **_put**. The last argument passed to the method is the value.

```
//Getters, all equivalent.
println worksheet.Cells.Item[row+1,1]
println worksheet.Cells.Item(row+1,1)
println worksheet.Cells._getItem(row+1,1)
```

```
//Settors, all equivalent.  
worksheet.Cells.Item[row+1,1] = new Date()  
worksheet.Cells._setItem(row+1,1, new Date())  
worksheet.Cells._putItem(row+1,1, new Date())
```

The method syntax is actually a little faster than the bracketed property syntax, but we recommend that you use the syntax that makes your intentions most evident.

Passing Values by Reference (in-out)

This page last changed on Nov 30, 2007 by [jasonsmith](#).

Java and **Groovy** are both "pass-by-value" languages. That is, if you pass a value to a method and the method modifies it, you don't see a change in the calling scope.

COM, on the other hand, supports both "pass-by-value" (or "byval") and "pass-by-reference" (or "byref"). "Byval" is sometime referred to as an "in" parameter, and "byref" is sometimes referred to as an "in/out" parameter, reflecting the direction the data is flowing. When you call a method that accepts a "pass-by-reference" parameter, the method can modify the parameter value, and this will be reflected in the calling scope.

Byref argument passing was always a favorite of **C/C++** programmers, who often use the result of a method to pass exception information. It was the default way to pass values in versions of **Visual Basic** through **6**. With the advent of modern try/catch exception handling, modifying values inside a method is generally considered bad programming practice. **Visual Basic** (and **COM**) still supports byref, but byval is now defined as the default setting. You should not have to deal with byref parameters often, especially when dealing with APIs that are designed for scripting. That doesn't mean it will never happen, though.

It shouldn't surprise you that **Scriptom** supports passing parameters by-reference, just in case you need it.

There are actually two ways that values are passed by-reference. For [COM Events](#), which do not support returning values, the only way to pass back information is through a byref parameter. That is all explained in the article, and it is actually pretty transparent. You don't have to do anything special for it to work. Your event handler can just change one of the arguments passed to it, and the caller sees the changed value.

The other way that values are passed by reference is through method calls. This one is a little more complicated, but only a little. **Scriptom** takes care of most of the scary details for you.

How Does it Work?

The basic concept is that you place the value in a wrapper object, pass the wrapper to the method, and finally get the new value back from the wrapper when the method returns. **Scriptom's** wrapper object is **VariantByref** ([org.codehaus.groovy.scriptom.VariantByref](#)).

One cool feature is that **Scriptom** allows you to just pass a **String** or an **Integer** or whatever type the method requires, if you don't care about getting back the changed value. Most of the time, even when a parameter is defined as byref, you don't really care about seeing the changed value. So you can ignore all of this.

Okay, so let's assume that you do care. The changed value matters to you. Otherwise you would have stopped reading in the last paragraph, right? Consider the following **VB6** object. It simply takes a byref **String** and modifies it.

```
Option Explicit
```

```
Public Sub StringByrefDemo(ByRef A As String)
    A = A & " VB6 was here!"
End Sub
```

The following example illustrates how to call the **VB DLL** so that the modified **String** is *not* lost.

```
Scriptom.inApartment
{
    def testObj = new ActiveXObject("MyDemo.PassByrefDemo");

    VariantByref svalue = new VariantByref("This is Groovy!");
    testObj.StringByrefDemo(svalue);
    assert svalue.value == "This is Groovy! VB6 was here!";
}
```

That is really all there is to it. Again, you shouldn't have to use this feature very often. But when the API is designed around byref parameters, this can be a lifesaver!

Scriptom Archive

This page last changed on Dec 18, 2007 by [jasonsmith](#).

Scriptom-1.5.zip	Build 10. Bundled with the Groovy 1.5 Windows Installer . Requires Groovy 1.5 and Java 5 or better.
Scriptom 1.2	(also Scriptom 1.1 and Scriptom 1.0) Original version, and the one that is documented in Groovy in Action . Requires Groovy 1.0 or better and Java 1.4 or better.

Copy of COM Scripting

This page last changed on Dec 10, 2007 by [jasonsmith](#).

Introduction

Scriptom ([scriptom-1.5.zip](#)), an optional Groovy module originally developed by [Guillaume Laforge](#), combines the elegant "syntactical sugar" of Groovy with the power of the [Jacob library \(Java COM Bridge\)](#). The result is something that looks an awful lot like **Windows Scripting Host** (WSH) scripting with VBScript - only it's for **Java**. Once installed into Groovy, **Scriptom** allows you to script **ActiveX** or **COM** Windows components from Groovy.

What this means is that you can use Groovy to automate **Word** or **Excel** documents, control **Internet Explorer**, make your PC talk using the **Microsoft Speech API**, monitor processes with **WMI** (Windows Management Instrumentation), or browse the **Windows Registry** using **WShell** (among many, many other things). It is also a convenient way to talk to custom **VB6** or COM-enabled **Microsoft.NET** libraries (compare this to the administrative headaches of getting **Java** and **.NET** to talk using **Web Services** - it's a no brainer). All this without ever leaving the comfortable **Java** universe.

Of course, **Scriptom** can be used only on **Microsoft Windows**.

Scriptom is bundled into the [Groovy Windows-Installer](#), and the most current version can be downloaded from this page (see below). The codebase is considered stable and feature-complete. The **Jacob** project - **Scriptom**'s foundation - was started in 1999 and is being used in thousands of production applications worldwide. **Scriptom** is only a few years old, but it is already stable and mature because it is built on an existing, best-of-breed platform.

Scriptom gives you all the **COM**-scripting power of **Jacob**, only it is a lot easier.



The **Scriptom** team

- [Guillaume Laforge](#)
- Dierk Koenig
- Marc Guillemot
- [Jason Smith](#)

Installation

Scriptom 1.5 requires **Groovy 1.5**. Because of dependencies on **Jacob 1.14**, **Scriptom** also requires **Java 1.5** or higher.

Download the project archive(s) and extract the files.

-  [scriptom-1.5.zip](#) Build 10 (12/10/2007) - **Scriptom** JAR file, **Scriptom-1.5.0bX-32.dll**, **Scriptom-1.5.0bX-64.dll**, Java source code, ANT build script, examples, tests, and utilities.
-  [scriptom-1.5-javadoc.zip](#) - **JavaDoc** for **Scriptom** and included type-library information.

Install the jar file and DLL file(s) into your project, and optionally install an update from Microsoft:

1. Add the **Scriptom** jar file (**scriptom-1.5.0bX-XX.jar**) into your Java classpath. It contains both **Scriptom** and **Jacob** class files, so you must not include **jacob.jar**.

 **Scriptom** contains a full (current) version of the **Jacob** library. If you are using **Jacob** directly elsewhere in your project, remove all references to it and use the version built in to **Scriptom**.

2. Copy both **Scriptom-1.5.0bX-XX.dll** files to somewhere on your **java.library.path**. (usually somewhere on the system 'PATH').



The **Scriptom DLL** naming convention allows multiple versions of **Scriptom** to run on the same machine. However, you can only run a single version of **Scriptom JAR** in any given project.

3. To avoid the dreaded **java.lang.UnsatisfiedLinkError**, download and install one of the following updates from Microsoft: [Microsoft Visual C++ 2005 SP1 Redistributable Package \(x86\)](#) or [Microsoft Visual C++ 2005 SP1 Redistributable Package \(x64\)](#). **Scriptom** doesn't support the **IA-64 (Itanium)** architecture at this time, mainly due to lack of interest. If you are wondering about the different processor architectures, check out the [x86-64 wiki](#). It is usually necessary to install these updates on **Windows Server 2003** and **Windows 2000**, and we've found that it may also be necessary for **Windows XP** and even **Vista**.

 A project can only use one version of **Scriptom** at a time. If you have installed **Groovy** using the **Groovy Windows Installer**, you must remove any versions of **Scriptom JAR** files or replace them with the latest version. A version of **Scriptom** is installed as part of the **Groovy Windows Installer** installation.

Scriptom 1.5 is not supported for **Groovy 1.0** and earlier (**Scriptom 1.2** is still available). Please contact us if this presents a serious problem for you.

Building from Source

The project archive contains all the **Scriptom** source files, Java source files from **Jacob**, and an ANT build script. To save space, the Groovy JAR files have been omitted from the archive. For a successful compilation, Groovy JAR files must be added to the **project/lib** folder.

The latest build requires **Groovy 1.5**.

Scriptom includes source files from **Jacob** version **1.14**. You don't need to download it from the **Jacob** project on **SourceForge.net**.

To build the project, run **project/build/make.bat**.

The build process requires **Java 1.5** or higher (**Java 1.6** recommended) and **ANT 1.6.5** or better.

Changes from Scriptom 1.x

Scriptom 1.5 is a substantial upgrade to previous versions of **Scriptom**, and *is not backward compatible*. We hope you will agree that it is worth a little code rework to get all these great new features!

- Provides simplified helper methods for dealing with COM apartment threading models.
- **ActiveXProxy** name changed to **ActiveXObject** to match WSH convention.
- **VariantProxy** no longer exists (the functionality was refactored into **ActiveXObject**).
- Variant values are converted to and from the equivalent Java type; no more calling **.value** on everything!
- Supports COM event callbacks using closures (this is still a work in progress, but usable as is).
- Supports indexed properties, including multiple indexes.
- Supports typed, multi-dimensional SafeArrays.
- Supports pass-byref (in/out) values, both in method calls and event handler callbacks.
- Supports COM enumerable types (so you can use **.each**, for example).
- Supports missing arguments (for optional parameters) in method/property calls and events.
- Includes constant definitions for several popular Windows applications, derived from these type libraries (see JavaDoc):
 - Microsoft Office 2003 (works with other versions as well)
 - Word 2003
 - Excel 2003
 - Outlook 2003
 - Access 2003
 - PowerPoint 2003
 - Microsoft Internet Explorer 6 (works with other versions as well)
 - Microsoft Scripting (i.e., FileSystemObject)

- Microsoft Speech API
- Windows Scripting Host (WSH)
- WbemScripting (WMI - Windows Management Instrumentation)
- Supports the latest features from **Jacob 1.14**, including new support for the **Decimal** data type and 64-bit integers.

Migrating from Previous Versions of Scriptom

Scriptom 1.5 is not backward compatible with previous versions of **Scriptom**. To get your scripts running again, do this:

- Change all references to **ActiveXProxy** into **ActiveXObject**.
- Wrap any code that references an **ActiveXObject** in **Scriptom.withMTA { ... }**, which replaces the way Scriptom previously handled COM threading.
- Remove all references to **.value** property references.
- Remove any statically typed references to **VariantProxy**.
- Support for COM events is greatly improved in this version - and also greatly changed. Refer to the **Events** section below for more information.
- Verify that your project is using the correct version of **jacobs.dll**.

Quick Start

Let's say you want an application that talks. Pure Java implementations aside (this is, after all, a Groovy/COM tutorial), and ignoring the fact that the default voice on pre-Vista machines sounds like [Dr. Zoidberg](#) with a sinus infection, you could use the **Microsoft Speech API (SAPI)** to get the job done.

You start by creating an **ActiveXObject** with the prog-id for **SpVoice**. Now you can call any of the methods it supports. By default, **SpVoice** will block until it is done speaking, but we're going to have it speak asynchronously and wait until it is done.

```
import org.codehaus.groovy.scriptom.*
import org.codehaus.groovy.scriptom.tlb.sapi.SpeechVoiceSpeakFlags;
import org.codehaus.groovy.scriptom.tlb.sapi.SpeechRunState;

//Definitive proof that you CAN talk and chew gum at the same time.
Scriptom.inApartment
{
def voice = new ActiveXObject('SAPI.SpVoice')
voice.Speak 'GROOVY and SCRIPT um make com automation simple, fun, and groovy, man!',
SpeechVoiceSpeakFlags.SVSFlagsAsync
while(voice.Status.RunningState != SpeechRunState.SRSEDone)
{
println 'Chew gum...'
sleep 1000
}
}
println 'Speaker is done.'
```

If you have scripted COM before, you are probably used to using "magic numbers" throughout your code in place of COM constants. In this code sample, we're using fully-qualified constants instead.

Scriptom includes fully JavaDoc'd constant and interface definitions from a number of commonly used type-libraries, and you can even create your own. The source code for generating COM type library

definitions for **Groovy** is written in **Groovy** 😊, and it's included in the project. It may not seem like a big deal to replace a couple of numbers, but it will be a lot easier in 10 years to find relevant information on **SpeechVoiceSpeakFlags.SVSFlagsAsync** than on the number **1** (Google returns a little more than 9 billion hits for the number '1', and about 1,000 for 'SpeechVoiceSpeakFlags.SVSFlagsAsync,' including hits on this paragraph). And besides, the code reads better.

Speaking of interfaces, it turns out that **SpVoice** supports several. You can test an **ActiveXObject** to see if it supports a given interface using **.supportsInterface**, and you can cast an **ActiveXObject** to a given interface using **.toInterface**.

This next example displays the COM interfaces that **SpVoice** supports (within the **SAPI** library only):

```
import org.codehaus.groovy.scriptom.*;
import org.codehaus.groovy.scriptom.tlb.sapi.SpeechLib;

Scriptom.inApartment
{
def voice = new ActiveXObject('SAPI.SpVoice')
SpeechLib.interfaces.each {name, iid -> if(voice.supportsInterface(iid)) println "SpeechLib.$name - $iid"}
}
```

Programmer's Guide

The Least You Need to Know about COM	how not to crash the JVM or lock your process
COM Data Types in Scriptom	supported types and conversions in Java, VB6, and VB.NET
COM Methods and Properties in Scriptom	calling COM methods and properties from Groovy
Passing Values by Reference (in-out)	how to let methods change the value of passed-in arguments
COM Events	support for COM events
All About Arrays	UNDER CONSTRUCTION

Examples

Here is a simple example that uses the Microsoft **ScriptControl** to evaluate a JScript expression. This is a very indirect way to add 2 and 2.

```
import org.codehaus.groovy.scriptom.*

Scriptom.inApartment
{
def scriptControl = new ActiveXObject("ScriptControl")
scriptControl.Language = "JScript"
println scriptControl.Eval('2.0 + 2.0;')
}
```

There are many, many potential uses for **Scriptom** - far to many to try to maintain as part of this documentation. So we've included a whole slew of meaty examples in the project archive for you to play with. We'd like to encourage you to go look at those examples, run them, and modify them. And if you come up with an especially interesting example, let us know about it. We may even include it in a future release!

Some additional examples included with **Scriptom**:

- Automated writing to and reading from **Excel** spreadsheets. Includes COM events example.
- Navigation in **Internet Explorer**. Includes COM events example.
- Gathering information about processes and Windows NT services using **WMI**.
- Parsing a *.msg file with **Microsoft Outlook**.

Consuming **Visual Basic 6** (VB6) and **Visual Basic.NET** COM-enabled DLLs.

Articles

Articles about **COM scripting** in general, and **Scriptom** in particular.

Getting Started with COM	January 11, 2008	Tips for exploring COM libraries, finding documentation, etc.
Bridging the Gap Between Java and .NET with Groovy and Scriptom	December 3, 2007	Implement FIPS 140-1 compliant SHA-1 in Java with Groovy , Scriptom , and Visual Basic.NET .
Juixe TechKnow	August 8, 2006	A short Microsoft Outlook example.
Siebel	March 17th, 2008	Siebel "business component" programming

Post Scriptom

All known (unresolved) issues and feature requests are listed in the [Scriptom Jira](#) database.

Changes to each build are summarized in the [Change Log](#).

Recent builds of **Scriptom** can be found [here](#). Older versions are archived:

Scriptom-1.5.zip	Build 10. Bundled with the Groovy 1.5 Windows Installer . Requires Groovy 1.5 and Java 5 or better.
Scriptom 1.2	(also Scriptom 1.1 and Scriptom 1.0) Original version, and the one that is documented in Groovy in Action . Requires Groovy 1.0 or better and Java 1.4 or better.

Scriptom 1.2

This page last changed on Nov 20, 2007 by [jasonsmith](#).



This is the page of the old version of Scriptom. As the new version, [Scriptom 2.0](#), brings with it a couple breaking changes, you may still want to use this version. However, we highly encourage you to switch to the [newer version](#) which solves a certain number of bugs and provide a much better integration to COM / ActiveX components.

Introduction

Scriptom is an optional Groovy module developed by [Guillaume Laforge](#) leveraging the [Jacob library \(JAvA COM Bridge\)](#). Once installed in your Groovy installation, it allows you to script any ActiveX or COM Windows component from within your Groovy script. Of course, this module can be used on Windows only.

Scriptom is especially interesting if you are developing Groovy shell scripts under Windows. You can combine both Groovy code and any Java library with the platform-specific features available to Windows Scripting Host or OLE COM automation from Office.

Installation

Zip bundle

The easiest way for installing Scriptom is to unzip the [Zip bundle](#) in your **%GROOVY_HOME%** directory. The distribution contains the jacob.jar and jacob.dll, and the scriptom.jar. The DLL needs to be in the bin directory, or in your **java.library.path** to be loaded by jacob.jar.

Building from sources

If you are brave enough and prefer using the very latest fresh version from CVS Head, you can build **Scriptom** from sources. Checkout modules/scriptom, and use Maven to do the installation automatically. If your **%GROOVY_HOME%** points at the target/install directory of your groovy-core source tree, just type:

```
maven
```

Otherwise, if you have installed Groovy in a different directory, you have two possibilities, either you change the property **groovy.install.staging.dest** to your **%GROOVY_HOME%** directory in the **project.properties** file, and run maven, or you can type:

```
maven -Dgroovy.install.staging.dest=%GROOVY_HOME%
```

Usage

Let's say we want to script Internet Explorer. First, we're going to import the ActiveX proxy class. Then, we're going to create a GroovyObjectSupport wrapper around the ActiveXComponent class of Jacob. And now, we're ready to use properties or methods from the component:

```
import org.codehaus.groovy.scriptom.ActiveXProxy

// instantiate Internet Explorer
def explorer = new ActiveXProxy("InternetExplorer.Application")

// set its properties
explorer.Visible = true
explorer.AddressBar = true

// navigate to a site by calling the Navigate() method
```

```
explorer.Navigate("http://glaforge.free.fr/weblog")
```

Note however that `explorer.Visible` returns a proxy, if you want to get the real value of that property, you will have to use the expression **`explorer.Visible.value`** or **`explorer.Visible.getValue()`**.

Limitations

For the moment, **Scriptom** is in a beta stage, so you may encounter some bugs or limitations with certain ActiveX or COM component, so don't hesitate to post bugs either in JIRA or on the mailing lists. There may be some issues with the mappings of certain objects returned by the component and the Java/Groovy counterpart.

An important limitation for the first release is that it is not yet possible to subscribe to events generated by the components you are scripting. In the next releases, I hope I will be able to let you define your own event handlers with closures, with something like:

```
import org.codehaus.groovy.scriptom.ActiveXProxy

def explorer = new ActiveXProxy("InternetExplorer.Application")
explorer.events.OnQuit = { println "Quit" }
explorer.events.listen()
```

But for the moment, event callbacks are not supported.

There is an experimental implementation currently in CVS Head, it does not work with the groovy command, but it does work when launching a script from a Java program with the GroovyShell object. There is perhaps a problem with Classworlds or Jacob, and the different classloaders. If anyone has a clue, I'm game!

Samples

If you checkout the **Scriptom** sources, you will find a few samples in the **src/script** directory. I will show you some samples in the following sub-sections.

Scripting Internet Explorer

```
import org.codehaus.groovy.scriptom.ActiveXProxy

// instantiate Internet Explorer
def explorer = new ActiveXProxy("InternetExplorer.Application")

// set its properties
explorer.Visible = true
explorer.AddressBar = true

// navigate to a site
explorer.Navigate("http://glaforge.free.fr/weblog")
Thread.sleep(1000)
explorer.StatusText = "Guillaume Laforge's weblog"
Thread.sleep(2000)

// quit Internet Explorer
explorer.Quit()
```

Scripting Excel

```
import org.codehaus.groovy.scriptom.ActiveXProxy

// create a proxy for Excel
def xls = new ActiveXProxy("Excel.Application")
xls.Visible = true
```



```

Thread.sleep(1000)

// get the workbooks object
def workbooks = xls.Workbooks
// add a new workbook
def workbook = workbooks.Add()

// select the active sheet
def sheet = workbook.ActiveSheet

// get a handle on two cells
a1 = sheet.Range('A1')
a2 = sheet.Range('A2')

// sets a value for A1
a1.Value = 123.456
// defines a formula in A2
a2.Formula = '=A1*2'

println "a1: ${a1.Value.value}"
println "a2: ${a2.Value.getValue()}"

// close the workbook without asking for saving the file
workbook.Close(false, null, false)
// quits excel
xls.Quit()

```

Warning: on my machine (WinXP Home), there is still an Excel.exe process running. I have no clue why Excel is still running.

Mixing VBScript or JScript with Groovy

```

import org.codehaus.groovy.scriptom.ActiveXProxy

// invoke some VBScript from Groovy and get the results!
def sc = new ActiveXProxy("ScriptControl")
sc.Language = "VBScript"
println sc.Eval("1 + 1").value

```

Scripting the Windows Shell object

```

import org.codehaus.groovy.scriptom.ActiveXProxy

// showing the current directory
def cmd = new ActiveXProxy("Scripting.FileSystemObject")
println cmd.GetAbsolutePathName(".").value

sh = new ActiveXProxy("Shell.Application")

// minimizing all opened windows
sh.MinimizeAll()

// opens an Explorer at the current location
sh.Explore(cmd.GetAbsolutePathName(".").value)

// choosing a folder from a native windows directory chooser
def folder = sh.BrowseForFolder(0, "Choose a folder", 0)
println folder.Items().Item().Path.value

def wshell = new ActiveXProxy("WScript.Shell")
// create a popup
wshell.popup("Groovy popup")

// show some key from the registry

```

```

def key = "HKEY_CURRENT_USER\\Software\\Microsoft\\Windows\\CurrentVersion\\Internet Settings\\User Agent"
println wshell.RegRead(key).value

def net = new ActiveXProxy("WScript.Network")
// prints the computer name
println net.ComputerName.value

```

Scripting Windows Media Player

```

import org.codehaus.groovy.scriptom.ActiveXProxy
import java.io.File

// create a proxy for the Shell object
def sh = new ActiveXProxy("Shell.Application")

// use a Windows standard folder chooser
def folder = sh.BrowseForFolder(0, "Choose a folder with wav files", 0)

// get the folder chosen
def folderName = folder.Items().Item().Path.value
println "Playing Wav files from: ${folderName}"

// create a Windows Media Player (from its Class ID)
def player = new ActiveXProxy("clsid:{6BF52A52-394A-11D3-B153-00C04F79FAA6}")

// for each file in the folder
new File(folderName).eachFile{ file ->
if (file.name.endsWith("wav")) {
println file
player.URL = file.absolutePath
// play the wav for one second
control = player.controls.play()
Thread.sleep(1000)
}
}

// close the player
player.close()

```

When event callbacks are supported, you will be able to subscribe to the `player.statusChange` event, so that you can play the wav entirely, before loading a new sample (instead of listening only to the first second of each sample).

Converting a Word document into HTML

This program takes a Word document as first parameter, and generate an HTML file with the same name, but with the `.html` extension.

```

import org.codehaus.groovy.scriptom.ActiveXProxy
import java.io.File

def word = new ActiveXProxy("Word.Application")

word.Documents.Open(new File(args[0]).canonicalPath)
word.ActiveDocument.SaveAs(new File(args[0] - ".doc" + ".html").canonicalPath, 8)
word.Quit()

```

Printing the contents of your Outlook Inbox

```

import org.codehaus.groovy.scriptom.ActiveXProxy

def outlook = new ActiveXProxy("Outlook.Application")

```

```
def namespace = outlook.GetNamespace("MAPI") // There is only "MAPI"

// 6 == Inbox; other values in Outlook's VBA documentation
def inbox = namespace.GetDefaultFolder(6)
def mails = inbox.Items

println "Elements in your Inbox: " + mails.Count.value

for (i in 1..mails.Count.value) {
  def mail = mails.Item(i)
  println i + ": " + mail.Subject.value + " (" + mail.Size.value + " bytes)"
}
```

Scriptom Articles

This page last changed on Mar 18, 2008 by [glaforge](#).

Articles about **COM scripting** in general, and **Scriptom** in particular.

Getting Started with COM	January 11, 2008	Tips for exploring COM libraries, finding documentation, etc.
Bridging the Gap Between Java and .NET with Groovy and Scriptom	December 3, 2007	Implement FIPS 140-1 compliant SHA-1 in Java with Groovy , Scriptom , and Visual Basic.NET .
Juixe TechKnow	August 8, 2006	A short Microsoft Outlook example.
Siebel	March 17th, 2008	Siebel "business component" programming

Bridging the Gap Between Java and .NET with Groovy and Scriptom

This page last changed on Feb 27, 2008 by [nirvdrum](#).

Ever wonder what all the fighting is about?

On the one hand, we have **Java**, with its basis in object-oriented theory, automatic memory management, dependency on a runtime, and a robust library. And on the other, we have **Microsoft.NET**, with its basis in object-oriented theory, automatic memory management, dependency on a runtime, and a robust library.

You'd think with all these two kids have in common, they would get along better. No such luck.

Up until now, getting **Java** to talk to **Microsoft.NET** has been only slightly more fun than being on the receiving end of a root canal. One book I picked up recently was all about interoperability using **Web Services**. **Web Services!** Not that there is anything wrong with **Web Services** in general, but I why do I need a web server, **WSDL**, and the overhead of two-way **XML** serialization if I just want a list of the processes on my local system (something **Java** cannot do)?

Maybe you've tried something like passing data to a spawned process using standard-input and standard-output. It's limited, but it works. You still need something like **SOAP** or **XStream** if you want to work with objects, and at least you don't have the overhead of a full blown web server. But it's still not simple. Or maybe you've tried using sockets. Same thing, but without incurring the overhead of starting and stopping a process every time you need to do something that is windows-ey. Still, that's not simple.

You are probably thinking, "There must be a better way." And that would make sense, because you took the time to read the title of this article, correct? I am here to tell you - *there is a better way*. In fact, I am here to tell you, it's *easy*.

Microsoft's Component Object Model (COM)

Microsoft spent decades developing this technology called **COM**. It stands for **Component Object Model**. "Wait a second," you say. "I think I remember reading about that somewhere. Isn't **COM** dead? Doesn't **.NET** make it obsolete?" You might think so, but look how long **.NET** has been around, and **Microsoft Office** is still compiled from plain old **ANSI C++**. Consider also that the **.NET** libraries for **Microsoft Office** are thin wrappers around the **COM** libraries that **Office** exposes. **COM** is embedded deeply in **Windows**, it is mature, stable, and it's not going anywhere.

Microsoft.NET has excellent support for **COM** interoperability. You can create and consume managed **COM** libraries using **VB.NET**, **C#**, or **C++/CLI**. It's almost trivial to do so in **VB.NET**, for example. You just set a few properties, build the project, and you've got a **COM-callable DLL**.

So if **COM** is there, it's mature, it's stable over decades, and it works for what you are doing, *why not just use it?*

Groovy and Scriptom

Groovy, for those who aren't already familiar with it, is a very cool dynamic language that is designed specifically to run on the **Java JVM**. The syntax is based on **Java**, and everything gets compiled to **Java** bytecode. **Java** programmers have an easy learning curve, and **Groovy** can be integrated seamlessly (and quickly) into existing **Java** projects. **Groovy** is a lot more expressive than **Java**, so you can typically get things done in about half the lines of code. And once you get used to it, **Groovy** is easier to read than **Java**.

Scriptom is an optional module for **Groovy** that lets you use **COM** objects without having to know anything (or at least very little) about the inner workings of **COM**. **Scriptom** takes advantage of **Groovy's** dynamic (late-bound) nature to map **COM** objects into **Groovy** objects at run-time. There are no type-libraries to deal with and no wrappers to maintain. Just code it and run it. It really is a lot like writing code using **VBScript** (except that **Groovy** is far more advanced as a language). It is almost eerie at times to see **Java** comingled with what appears to be something straight out of **WSH (Windows Script Host)**. Thus, the name - "*Script-om*." It's very script-like.

Let's Do Something! FIPS 140-1 on Java

It's high time for an example. It is said that the best way to learn is by doing, so let's put together a small application. And what's more, let's make it practical.

I was working on a project recently that needed a [FIPS 140-1](#) compliant cryptographic hash/digest algorithm. I needed to protect user passwords, and my client has some pretty strict rules about which cryptographic algorithms may and may not be used. **Java** implements several hash/digest algorithms, but none of them are compliant with **FIPS 140-1**. What this means is that I had to look outside of **Java** for a solution.

After Googling for several hours, I realized that it is pretty hard to find anything that is certified as **FIPS 140-1** compliant. There are some big libraries, mostly written in **C++** with **Java JNI** wrappers. One or two are open source, but most cost money (and they don't list a price - you *know* what that means). All of them were far too complex for my needs. I don't want to have to maintain yet-another-set-of-libraries for just one measly function point.

So, cutting to the chase, it turns out that a number of the algorithms available in the **MS-CAPI** (**Microsoft Crypto API**) are certified **FIPS 140-1** compliant! That's right, what I needed was built right in to the base installation of Windows. All I needed to do was figure out how to get from the Windows SDK API level into **Java**. After a little more research, I discovered that Microsoft has wrapped parts of the **MS-CAPI** into the **.NET Framework**. One of these wraps the **FIPS 140-1** compliant implementation of [SHA-1](#). Perfect!

So all I had to do was:

- create a **.NET DLL** with **COM**-accessible objects, and
- access it using **Groovy** and **Scriptom**.

Piece of cake!



What I am showing you here isn't sufficient for securely hashing a password. You'd need to add a unique seed value, such as the user's name or ID number, to prevent simple birthday attacks. There are some other things you would need to do to strengthen the password to prevent easy brute-force attacks. Consult your local security guru before using any cryptography. If you don't understand what you are doing, you are probably doing it wrong (and fooling yourself about how secure you are in the process). Poorly implemented cryptography is often as bad, or worse, than none at all.

Create a COM-Accessible VB.NET Library

First things first. Let's create the **DLL**. We'll be wrapping Microsoft's **SHA1CryptoServiceProvider** (pretty trivial to code), and we'll also be walking through all the steps to make the **DLL COM**-accessible.

I'm using **Visual Basic** in this example, but with a little translation this should work with any of the mainstream **.NET** languages.

Step 1. Create a New Project

Open **Visual Studio** and create a new **VB** class library project called **MyFips140Crypto**.

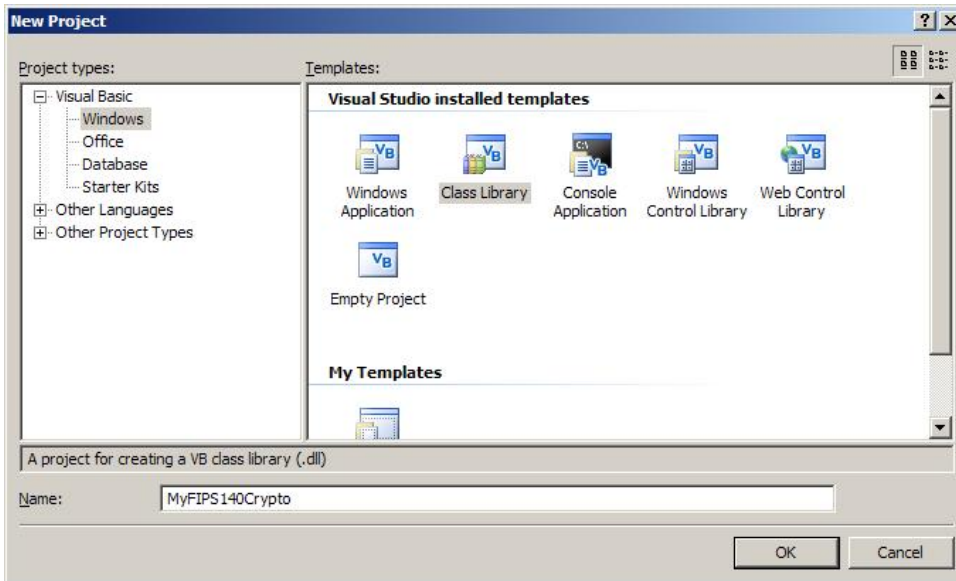

Step 2. Add the Code

Rename **Class1** to **SHA** and add the following code:

```
Option Explicit On
Option Compare Text
Option Strict On
```

```
Imports System.Security.Cryptography
Imports System.Text
```

```
<Microsoft.VisualBasic.ComClass()> Public Class SHA
<System.Runtime.InteropServices.ComVisible(False)> _
Private Provider As SHA1CryptoServiceProvider

' A creatable COM class must have a Public Sub New()
' with no parameters, otherwise, the class will not be
' registered in the COM registry and cannot be created
' via CreateObject.
Public Sub New()
MyBase.New()

Provider = New SHA1CryptoServiceProvider()
Provider.Initialize()
End Sub

''' <summary>
''' Generates the SHA hash of an input string.
''' </summary>
''' <param name="Input">
''' A string of characters;
''' case is significant, and unicode is accepted.
''' </param>
''' <returns>
''' A 20-byte hash representing the 160 bit result.
''' </returns>
''' <remarks>
''' This uses the MS CAPI algorithm for SHA-1, so it
''' is FIPS 140-1 compliant.
''' </remarks>
Public Function GenerateHash(ByVal Input As String) As Byte()
Return Provider.ComputeHash(Encoding.Unicode.GetBytes(Input))
End Function
```

End Class

Step 3. Enable COM

To enable **COM** support, open the project properties and click the **Assembly Info** button. Fill in the dialog any way you want, but make sure that **Make assembly COM-Visible** is checked.

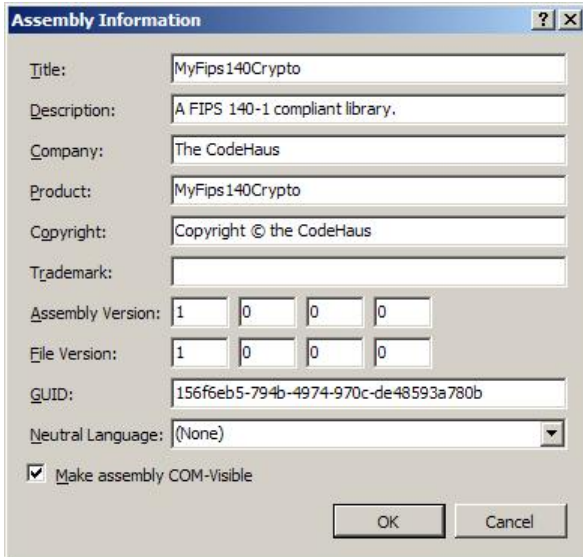

Step 4. Give It a Strong Name

What is a "strong name," you ask? Well, it is some sort of Microsoft security cryptographic digital signature thingy. Why do you care? In most cases, you won't. The important thing to remember is that you won't be able to successfully register the library later without this.

Lucky for us, Microsoft has made this step relatively easy. From the project properties page, you can have **Visual Studio** create a new strong name key file for you. You can optionally protect the key file with a password.



Once the strong name key file is associated with your project, you generally don't have to worry about it again.

Step 5. Build It

Build the project.

Step 6. Register It

Open **Visual Studio 2005 Command Prompt**. It is one of the tools that comes standard with **Visual Studio**. Navigate to the folder where your compiled DLL is going to reside, and type in the following command:

```
C:\work\MyFips140Crypto\MyFips140Crypto\bin\Release>regasm MyFips140Crypto.dll /codebase
```

 The **/codebase** parameter must be specified. If you forget, the assembly will appear to be registered correctly, but you will get a "Could not co-create object" exception when you try to run this from **Groovy**.

If you have been lucky enough to get everything right so far, you'll get a confirmation message telling you that the assembly was registered successfully. Congratulations!

 If you are using **Visual Studio Express**, you may not have a **Visual Studio 2005 Command Prompt**. The **regasm.exe** utility is available on your machine, and you can access it by searching for the file and adjusting your path environment variable, or by installing the full **Microsoft.NET SDK**.

 If you add new **COM**-visible classes to your library, you will have to re-register the **DLL** in order for **Groovy** to be able to see them.

 The **regasm.exe** utility requires **Administrator** privileges to execute. This can affect installations, and is particularly relevant on **Windows Vista**, since the command prompt must be started with the correct privileges.

Groovy!

Okay, that was tough (not really). There are a couple of not-so-obvious steps involved in creating even a simple **COM**-enabled **.NET** library. Fortunately, once you know all the steps, you just follow the same recipe. Once you have set up a **.NET** project this way, it is easy to add additional methods and classes.

You might expect that for the **Groovy** portion of this project, there is a similar type of overhead incurred. You'd be wrong though. With **Groovy**, it is more like scripting. I wasn't lying earlier when I said this was easy. Here is all the code you need to compute a **FIPS 140-1** compliant **SHA-1** hash of an arbitrary string:

```
import org.codehaus.groovy.scriptom.*;

Scriptom.inApartment
{
  ActiveXObject sha = new ActiveXObject('MyFips140Crypto.SHA')
  SafeArray hash = sha.GenerateHash('Your plain text goes here.')
  println hash.toArray() //Converts COM SafeArray to Java byte[]
}
```

There you have it. A **FIPS 140-1** approved **SHA-1** implementation in about 20 lines of code. That was easy.

 **COM** objects always run in an "apartment." Different "apartments" correspond to different threading models, and the **COM** threading models don't quite correspond to **Java's** threading model. To help you with initialization and teardown of **COM** apartments within **Java**, **Scriptom** provides the **.inApartment** method. It is considered best practice to wrap any **COM** objects in an **.inApartment** closure. Threading in **Scriptom** can also be managed by calling the methods on the **com.jacob.com.ComThread** object.

Integrating with Java

This part is for you if you are new to **Groovy**. If you have been using **Groovy** for a while, you're done. Go forth and codify already.

At first glance, it might not be obvious how easy it is to integrate this into your existing **Java** project. It's easy. It's really, really easy. **Groovy** objects are compiled to **Java** byte-code. In other words, **Groovy** objects are **Java** objects. So for the most part, **Java** can call methods on **Groovy** objects just like calling methods on another **Java** object. That's what they mean when they say: "**Groovy is Java!**"

So let's wrap our script into a **Groovy** object so that it can be easily called from **Java**. Create a file called **Fips140Sha1.groovy** in **/org/yourcompany/yourproject**:

```
package org.yourcompany.yourproject;

import org.codehaus.groovy.scriptom.*;

public class Fips140Sha1
{
    public byte[] generateHash(String input)
    {
        return Scriptom.inApartment
        {
            ActiveXObject sha = new ActiveXObject('MyFips140Crypto.SHA');
            SafeArray hash = sha.GenerateHash(input);
            return hash.toArray(); //Converts COM SafeArray to Java byte[]
        }
    }
}
```

Look familiar? It's kind of hard to tell the difference between **Groovy** syntax and **Java** syntax sometimes, isn't it? Compile your project with **Groovyc** (either the command-line executable or the ANT task) and you are done.

Wrap Up

We've only just scratched the surface of what it is possible to do with **Scriptom** and **.NET**, not to mention all the things you can do with the hundreds of existing **COM** libraries that are available in **Windows**. No one is suggesting that you give up **WORA**, but for those **MeSsy** jobs that **Java** just can't do, this is one approach that is quick, painless, and pretty easy to maintain over time. If you like what you see, or if you want to provide some constructive criticism, drop by the **Groovy users** mailing list and let us know what you think.

[Jason Smith](#) is currently a member of the **Scriptom** development team.

Getting Started with COM

This page last changed on Jan 11, 2008 by [jasonsmith](#).

Code written with **Scriptom** looks great and is easy to read. Sure. But it may not be as easy to write as it is to read. Where is the look-ahead help? Where is the integration with your favorite IDE? How do you get started writing code against **COM** objects, many of which have little or no online documentation? In this rather short article, I talk about why **Scriptom** does not have IDE integration, along with some techniques and tools you can use to make **COM** programming with **Scriptom** much easier.

No IDE Integration for Scriptom

Let's start with IDE integration. To make it short, there isn't any, and it isn't planned. The trouble is, **Scriptom** uses "late bound" **COM** calls, exclusively. Every **COM** object in **Scriptom** is just an **ActiveXObject** to **Groovy**. Even at runtime, there is no reliable way to determine exactly what kind of an object you are working with under the covers. **Scriptom** just passes the method name, along with the arguments, to **Windows** - and trusts that everything will go well.

For those of us who are used to static typing, this may seem like a dangerous practice. I think you will find, though, that it works surprisingly well. It also simplifies things considerably. Have you seen the number of **COM** wrappers that **Microsoft.NET** has to support (for some, multiple versions of the same library)? **Scriptom** doesn't require a **COM** wrapper generator (though it does include constant definitions for some **COM** libraries). You can just write your code and run it. And it just works.

Scriptom uses the same calling mechanism that is used by Microsoft's typeless scripting languages, like **VBScript** and **JScript**. It is also the calling convention that is used from **Visual Basic 6** or **VBA** when you are working with an **Object**. That is why they call it **Scriptom**. It uses the calling convention that is normally used by scripting languages.

An Easier Way than Trial and Error

So if there is no IDE integration for **Scriptom**, how do you figure out the **COM** thing? Here are some ideas, based on my own experience working with **COM**. These aren't quite the same as having full IDE integration, like **Java** in **Eclipse**, but in my experience they do help you get the job done.

- Use **VB6** or **VBA** to browse the object models and write sample code. **Visual Basic 6** and **VBA** have a nearly identical set of tools for browsing objects, setting references to **COM** libraries, and for look-ahead help. Most **COM** libraries were designed to be compatible with **Visual Basic**, and those will usually work well with **Scriptom**. **VB6** is part of **Visual Studio 6**, which is scheduled to be desupported by Microsoft in 2008. **VBA** is available as the macro language in all the **Microsoft Office** products, and in many other products as well.
 - Use *Visual Studio.NET* to browse the object model. I don't recommend this over **VB6/VBA** because the support for **COM** is a little more obscure in the **Microsoft.NET** products. However, in a pinch, it works, and the **Visual Studio Express** products are free.
- Buy a book. There are many books available that cover **COM APIs** for specific products. For example, a used copy of **Excel 2002 VBA on Amazon would run you less the \$15, including shipping. When you are working with the really complex applications, like Excel and Word, I have always found it beneficial to have a second opinion.**
- Use the web to find examples. Some people call it "Programming by Google." If you want to do something, you can bet that some other fool has already done it and published it somewhere on the web.
- Read the manual. Use Microsoft's search tool at <http://msdn.microsoft.com> to find the official documentation. Some of it is very good, some it will leave you with questions, but all of it is official.
- Don't write code, write a macro. For **Microsoft Office** applications that support macros, the macro language is **VBA**. This means that when you create a macro, **Word** or **Excel** will actually write the code for you. It is usually trivial to port **VBA** to **Groovy/Scriptom**. This is an excellent way to figure out how to do obscure tasks in **Office**.

There. That should get you started off on the right foot. Enjoy!

This article was consolidated from ideas developed in an email thread in the **Groovy users** list. Thanks to Thomas Elmiger and A. Tres Finocchiaro.

Using Scriptom to Automate Microsoft Excel

This page last changed on Nov 20, 2007 by [jasonsmith](#).

Why Scriptom?

There must be a dozen different libraries out there that support reading and writing **Excel** documents. Some, like [POI](#) or [OpenXLS](#), let you manipulate **Excel** files directly from Java. These libraries don't use **Microsoft Excel**, so they work well in mixed OS environments. However, they don't support some key features of **Excel** (there are significant limitations), and their APIs don't correspond to **Excel's COM API**, so it can be difficult at times to figure out how use them to do even simple things.

Other libraries, like [COM4J](#), [JCOM](#), and [JACOB](#) let you use **Excel** automation to read and create **Excel** files, either directly or through wrapper classes generated from **COM** type libraries. This gives you full access to the complete featureset of **Excel**. It also limits you to **Windows**. It can be sometimes be difficult to translate from Microsoft's Visual Basic-oriented documentation to the corresponding library/wrapper in Java. This can be particularly challenging if you aren't already up to speed on **COM** and the **Excel API** - which is probably true for most Java programmers. **Excel** automation is also a lot slower than direct file manipulation (process startup overhead, process-to-process communication).

Scriptom is a **COM** automation library for **Groovy**, so it falls squarely into the second group. In fact, **Scriptom** is an extension of [JACOB](#). **JACOB** does the heavy lifting, and **Scriptom** makes it groovy.

*So why would you use **Scriptom** over one of the alternatives?*

Scriptom is intended to replicate the feel of COM scripting - as much as possible - but with Groovy instead of VBScript. It looks like COM scripting, and it feels like COM scripting. So when you are, for instance, translating a VBA macro to its equivalent Groovy, there is very little translation involved. You can't quite do a copy-paste, but it's close. And when you are programming against the Microsoft documentation for the Excel API, you don't have to ask a lot of questions. The code simply works the way it's documented.

Additionally, Scriptom provides special support for scripting Excel. The Scriptom library contains definitions for all the constants in the Excel type library. Scriptom also includes **ExcelHelper** ([org.codehaus.groovy.scriptom.util.excel.ExcelHelper](#) - whew!), which gives you an easy way to work with Excel documents in a multiprocessing (server) environment.

Are you feeling groovy yet?

Scriptom is suitable for use in low-to-medium volume tasks where Excel is available. For example, it is useful in batch jobs, where you aren't too concerned about execution time. And it can be used to produce reports in Excel format for a web site (throw in a pie chart in a few lines of code), as long as you don't try to deliver more than one report every couple of seconds.

If you feel the need for speed and you can live with its limitations, consider POI. In fact, many Java-based frameworks and libraries that provide Excel support out of the box (Cocoon, ColdFusion, etc.) use POI under the covers. However, if your goals are *easy-to-write*, *easy-to-maintain*, and *full-featured*, and the **Windows/Excel** thing isn't a showstopper, your best bet may be **Scriptom**.

Let's Get Started!

LINK TO DOCUMENT WITH INSTALLATION INSTRUCTIONS

Enough with the introductions. Let's get started with an example that shows just how easy it is to work with Excel using Scriptom.

<http://poi.apache.org/hssf/index.html>

<http://www.rgagnon.com/javadetails/java-0516.html> \\\- various ways to read and write Excel documents

minimalistic framework, and syntax that corresponds directly to the Microsoft documentation

The Least You Need to Know about COM

This page last changed on Nov 02, 2007 by [jasonsmith](#).

The [wiki on COM](#) explains, among many other things, that **COM (Component Object Model)** is an older Microsoft technology that encompasses **OLE, OLE Automation, ActiveX, COM+** and **DCOM**. **Microsoft.NET** is not based on **COM**, but for the most part it supports it seamlessly. **Scriptom** lets you easily integrate these technologies into your **Java/Groovy** project.

Despite the fact that **Visual Basic** versions up through 6 were abstractions on top of **COM**, it's not at all simple. I won't go into the details here (the [wiki](#) does a better job than I could at explaining it all). The important point to remember is that **COM** is fundamentally a **C/C++** based technology that was developed using pre-Java ideas of object orientation. To be specific, **C/C++** apps are generally responsible for cleaning up allocated memory, and the **COM** threading models differ somewhat from **Java**.

Because **C++/COM** and **Java** aren't quite compatible, it is possible to get **Scriptom** to randomly crash your JVM (core-dump), use up all available memory, peg the CPU at 100% for hours on end, or prevent your Java process from exiting. If you use it correctly, though, you'll find that **Scriptom** is rock-solid stable.

This article is going to explain, in very simple terms, some of the differences between **COM** and **Java**, and how to deal with the issues they present in the simplest way possible.

Apartment Threads for Absolute Beginners

Sorry about this, but you have to manage **COM** thread apartment contexts. The good news is that this is not nearly as onerous as it sounds. You can do this using **Jacob** directly (giving you a lot of flexibility). Of course, this article is about the simple, safe ways to use **Scriptom**, so we'll leave the advanced **Jacob** topics for another.

Scriptom provides an even simpler and safer way that handles 95% of the cases you are likely to run into. It also tends to produce the most stable applications, making it ideal for use on the server side. All you have to do is wrap your code in a **Groovy** closure, like this:

```
Scriptom.inApartment
{
  ...
}
```

When you wrap your Scriptom code using **.inApartment**, the thread apartment is initialized if needed, and all **COM** resources are released when you are done. You can do this over and over again in a thread, and you can also nest calls to **.inApartment**, allowing you to use it safely with other code (this addresses an issue with **Jacob**). You'll see this pattern time and time again in our examples and test code.

The main side-effect of this is that you have to define all your **ActiveXObject**s within the apartment scope (the closure). In case that doesn't work for your purposes, you can freely use **Jacob** to manage your **COM** thread contexts. However, you can't safely mix and match the **Scriptom** thread management with **Jacob** calls in the same thread.

It's NOT a Memory Leak!

It should come as no surprise that **COM** strings, numbers, and objects are not interchangeable with **Java** strings, numbers, and objects (though **Scriptom** does a pretty good job of making them look as if they are). Every time we exchange data with a **COM** library, the **Java** data-type needs to be converted to and from a form that is suitable for **COM**. That form just happens to be Microsoft's (pseudo) universal data type: the **Variant**. Without going too deeply into the murky details, a **Variant** can store various forms of numbers, strings, and objects. You don't normally need to worry about this because **Scriptom** handles all the conversion details for you.

What you need to know about **Variants** is that they can't be completely reclaimed by standard **Java** garbage collection. There is a little "residue" that **Jacob** has to hold on to even after you are finished

using the **Variant**. This is necessary to prevent random JVM crashes (it's a **C/C++/JNI** thing). Over a large number of calls, this residue can fill all the memory on your server.

Don't panic! It isn't a memory leak. When you exit the **.inApartment** closure, the **COM** context is released and all the memory is reclaimed.

There is one more thing you should be aware of. The clean-up process gets much slower if you make a very large number (millions) of **COM** calls before cleaning up. So for a long running thread, you are better off breaking up the apartment contexts rather than having one context for the whole thread.

In short:

- Use an **.inApartment** closure around your **COM** code (more specifically, any code that uses **ActiveXObject**).
- Break **.inApartment** closures into reasonably-sized chunks.

Gant

This page last changed on Dec 10, 2007 by [russel](#).

Gant has moved: it has become a project in its own right and has its own space -- <http://gant.codehaus.org>.

GFreeMarker

This page last changed on Mar 04, 2008 by [standtrooper](#).

Contribution Overview

GFreeMarker is an integration of the FreeMarker template engine for Groovy. It allows adding plugins written in Groovy for content rendering, making FreeMarker+Groovy just as easy as [Smarty](#). This way of doing avoids security issues related to allowing direct Groovy scripting in templates. With GFreeMarker, **you** create plugins, and make it available to customers.

Team Members

Cedric Champeau <cedric dot champeau at lingway dot com>

Download

Distributions

[GFreeMarker 0.2](#)

[GFreeMarker 0.2 \(javadoc\)](#)

[GFreeMarker 0.2 \(sources\)](#)

Installing

Pending.

Pre-requisites

None.

Documentation

How does it work ?

Imagine your customer requires an URL Encoding text transform, and that FreeMarker does not offer this transformation. Then, you would just need to :

- Create a plugin named urlencoder that implements the IGroovyFreeMarkerPlugin interface
- Copy this plugin into the Groovy FreeMarker template engine plugins directory

That's all ! Now your customer can access it quite directly in the template. For example :

```
<@groovy plugin="urlencoder">this is an expression that will be converted to its URL Encoding form</@groovy>
```

Writing a plugin

Here's a sample plugin which converts a string through URL encoder :

```
import org.codehaus.groovy.gfmfreeMarker.IGroovyFreeMarkerPlugin

class urlencoder implements IGroovyFreeMarkerPlugin {
String transform(Map params, String content) {
URLLEncoder.encode(content);
}
}
```

Using the template engine

Here's a sample code which shows how easy it is to embed FreeMarker as a template engine for Groovy.

```
import org.codehaus.groovy.gfreemarker.FreeMarkerTemplateEngine

def tpl = '''
Hello, ${user.name}
<@groovy plugin="urlencoder" mode=user>this is a test ${user.name}</@groovy>'''
def engine = new FreeMarkerTemplateEngine("plugins")
def binding = ["user" : ["name":"cedric"]]
println engine.createTemplate(tpl).make(binding)
```

This code assumes a directory called *plugins* is in the working directory. The template engine will dynamically load the "urlencoder" class.

Developers

Source Control

<http://svn.codehaus.org/groovy-contrib/gfreemarker/trunk/>

Building

GFreeMarker uses Maven2 as its build tool. Follow the instructions at <http://maven.apache.org> or install an IDE which has Maven 2 support (I personally use [IntelliJ IDEA 7](#)).

Contributing

Feel free to contribute, as I don't have much time to spend on this project.

Community

Mailing List(s)

<http://groovy.codehaus.org/Mailing+Lists>

Issue tracker

N/A

Google Data Support

This page last changed on Sep 25, 2006 by [paulk_asert](#).

The GData module makes using the Google Data APIs easier from within Groovy.

Google supports a general data access protocol [GData](#). They supply a [Java library](#) which wraps the protocol and provides a higher level API. Groovy programs can make use of this library "as is". However, it's not very Groovy! The GData module provides a couple of Categories which make it a lot easier to manipulate the Google data.

Here's an example of reading events from Google Calendar and then adding an event to the calendar:

```
import com.google.gdata.client.*
import com.google.gdata.client.calendar.*
import com.google.gdata.data.*
import com.google.gdata.data.extensions.*
import com.google.gdata.util.*

import groovy.google.gdata.GDataCategory
import org.codehaus.groovy.runtime.TimeCategory

def myId = System.properties.id
def myPassword = System.properties.pass
def feedUrl = "http://www.google.com/calendar/feeds/$myId/private/full"

use (TimeCategory, GDataCategory) {
def myService = new CalendarService("codehausGroovy-groovyExampleApp-1")

myService.userCredentials = [myId, myPassword]

//
// List existing entries
//

//
// Get at most 20 events in the period starting 1 week ago and ending 4 weeks in the future
//
myService.getFeed(feedUrl, 1.week.ago, 4.weeks.from.today, 20).entries.each {entry ->
entry.times.each {time ->
println "${entry.title.text} From: ${time.startTime.toUiString()} To:
${(time.endTime.toUiString())}"
}
}

//
// Get at most 20 events in the period starting 1 year ago lasting 2 years
//
myService.getFeed(feedUrl, 1.year.ago, 2.years, 20).entries.each {entry ->
entry.times.each {time ->
println "${entry.title.text} From: ${time.startTime.toUiString()} To:
${(time.endTime.toUiString())}"
}
}

//
// Add an entry
//

// Use standard groovy magic to set the properties after construction
def me = new Person(name: "John Wilson", email: "tugwilson@gmail.com", uri: "http://
eek.ook.org")

//
// Need special magic in the GDataCategory to do this
//
```

```
// title and content are treated as plain text. If you want XHTML or XML then pass a closure or
a
// Buildable object and it will run it in a builder context
//
// Note that we can't use title and content in the Category as they are already properties of
the class.
// Later I'll create a custom MetaClass for EventEntry which will let us use these names. Until
then we'll mangle them
//
// author can be a single Person or a list of Person
//
// time can be a single When or a list of them
//
def newEntry = new EventEntry(title: "This is a test event", content: "this is some content",
author: me,
time: new When(start: 1.hour.from.now, end: 2.hours.from.now))

myService.insert(feedUrl, newEntry)
}
```

Gram

This page last changed on Sep 25, 2006 by [paulk_asert](#).

Gram is a simple xdoclet-like tool for processing doclet tags or Java 5 annotations in source code or bytecode and auto-generating files, data or resources.

Gram = Groovy + [JAM](#). JAM does all the hard work of abstracting away the details between annotations and doclet tags and handling Java 1.4 and 5 compliance. Groovy takes care of the scripting, code generation & templating. Gram is the little tidy bit of code in between.

The sources can be found here : [Gram](#)

Using Gram

You can use the Gram class as a main() and run it from your IDE if you wish. There is a GramTask as well for using it inside Ant.

Often since JAM depends on Sun's doclet stuff, you can have issues running the GramTask inside Maven and sometimes Ant. So I tend to run the Gram command line tool from inside an Ant build. e.g.

```
<java classname="org.codehaus.gram.Gram" fork="true">
<classpath refid="tool.classpath"/>

<!-- the directory where the source code lives -->
<arg value="src/java"/>

<!-- the groovy script to run to generate stuff -->
<arg value="src/script/MyGram.groovy"/>
</java>
```

Example script

Here's a simple example which just lists all the hibernate persistent classes in your source code

```
def persistentClasses = classes.findAll { it.getAnnotation("hibernate.class") != null }

println "Found ${persistentClasses.size()} instances out of ${classes.size()}"

persistentClasses.each { c ->
println c.simpleName

for (p in c.properties) {
println "  property: ${p.simpleName}"
}
}
```

Jar Dependencies

Gram depends on:

- The Groovy 'all' jar (groovy-all-*.jar)
- JAM from the [Annogen](#) project
- and potentially: xml-apis.1.02b.jar and Sun's tools.jar

Articles

You might find some more documentation in the form of blog posts by Andres Almiray:

- [Getting started with Gram](#)
- [Going further with Gram](#)

GraphicsBuilder

This page last changed on Mar 17, 2008 by [aalmiray](#).

GraphicsBuilder is a Groovy builder for Java 2D

Module Overview

GraphicsBuilder provides an easy way to create Java2D graphics in a similar manner as [JavaFX Script](#) but in a groovier way. Here is the Groovy logo (kind of) drawn with GraphicsBuilder using the built-in GraphicsPad application

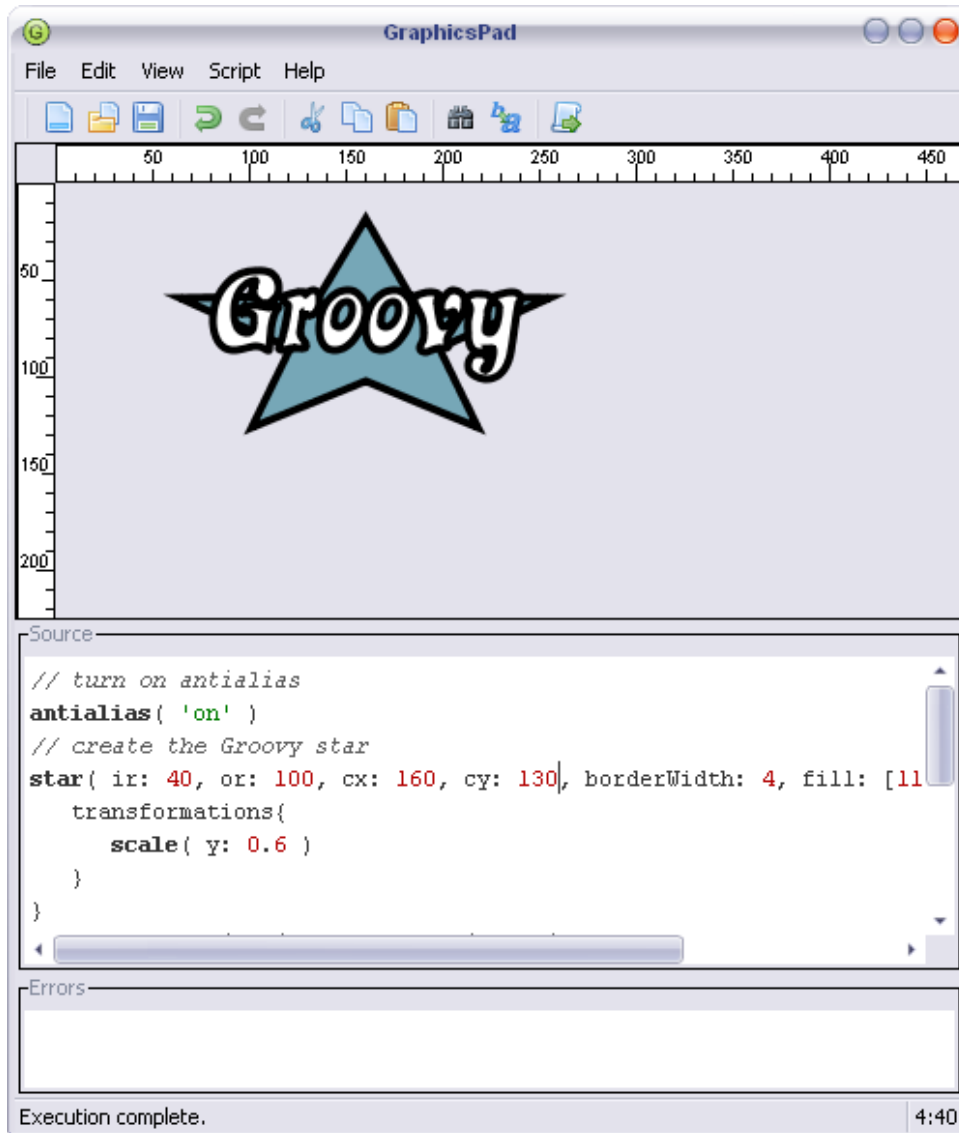

This is the code used to draw the logo

```
// turn on antialias
antialias( 'on' )
// create the Groovy star
star( ir: 40, or: 100, cx: 160, cy: 120, borderWidth: 4,
fill: [118,167,183] as Color ){
transformations{
scale( y: 0.6 )
}
}
// load the swingtime font, get it? Swing
```

```

def fontFile = new File("SWINM____.TTF")
font( Font.createFont(Font.TRUETYPE_FONT,fontFile).deriveFont(50.0f) )
// draw the text
text( text: 'Groovy', borderWidth: 4, fill: 'white' ){
transformations{
translate( x:80, y:30 )
scale( y: 1.2 )
}
}
}

```

Download

Distributions

[graphicsbuilder-0.5.1](#)

Installing

Drop all jar files into \$GROOVY_HOME/lib
Drop the scripts into \$GROOVY_HOME/bin

Since Groovy 1.1-beta-3 the Windows NSIS Installer includes GraphicsBuilder as an additional module to install (<http://groovy.codehaus.org/Windows+NSIS-Installer>)

Pre-requisites

GraphicsBuilder requires Groovy 1.5.0+ and Java 1.6+
Additional extensions have the following requisites

Extension	Java Version	Extra libraries
graphicsbuilder-ext-swingx	1.6+	swingx-0.9.2
graphicsbuilder-ext-svg	1.6+	batik-awt-util-1.7, batik-ext-1.7, batik-gui-util-1.7, batik-util-1.7
graphicsbuilder-ext-jdk6	1.6+	

Documentation

- [GraphicsBuilder - Animation](#)
 - [GraphicsBuilder - Animation - Bind](#)
- [GraphicsBuilder - GDK](#)
- [GraphicsBuilder - Groodles](#)
 - [GraphicsBuilder - Groodle1 - Screencast](#)
 - [GraphicsBuilder - Groodle2 - Screencast](#)
 - [GraphicsBuilder - Groodle3 - Screencast](#)
- [GraphicsBuilder - Groups](#)
- [GraphicsBuilder - Misc](#)
 - [GraphicsBuilder - Misc - Antialias](#)
 - [GraphicsBuilder - Misc - Clip](#)
 - [GraphicsBuilder - Misc - Color](#)
 - [GraphicsBuilder - Misc - Draw](#)
 - [GraphicsBuilder - Misc - Font](#)
 - [GraphicsBuilder - Misc - Image](#)
 - [GraphicsBuilder - Misc - RenderingHint](#)
- [GraphicsBuilder - Outlines](#)
 - [GraphicsBuilder - Outlines - CubicCurve](#)
 - [GraphicsBuilder - Outlines - Line](#)

- [GraphicsBuilder - Outlines - Polyline](#)
- [GraphicsBuilder - Outlines - QuadCurve](#)
- [GraphicsBuilder - Paints](#)
 - [GraphicsBuilder - Paints - BorderPaint](#)
 - [GraphicsBuilder - Paints - ColorPaint](#)
 - [GraphicsBuilder - Paints - GradientPaint](#)
 - [GraphicsBuilder - Paints - LinearGradient](#)
 - [GraphicsBuilder - Paints - MultiPaint](#)
 - [GraphicsBuilder - Paints - Paint](#)
 - [GraphicsBuilder - Paints - RadialGradient](#)
 - [GraphicsBuilder - Paints - TexturePaint](#)
- [GraphicsBuilder - Shapes](#)
 - [GraphicsBuilder - Area - Add](#)
 - [GraphicsBuilder - Area - Intersect](#)
 - [GraphicsBuilder - Area - Shape](#)
 - [GraphicsBuilder - Area - Subtract](#)
 - [GraphicsBuilder - Area - Xor](#)
 - [GraphicsBuilder - Shapes - Arc](#)
 - [GraphicsBuilder - Shapes - Arrow](#)
 - [GraphicsBuilder - Shapes - Circle](#)
 - [GraphicsBuilder - Shapes - Cross](#)
 - [GraphicsBuilder - Shapes - Donut](#)
 - [GraphicsBuilder - Shapes - Ellipse](#)
 - [GraphicsBuilder - Shapes - Morph](#)
 - [GraphicsBuilder - Shapes - Path](#)
 - [GraphicsBuilder - Shapes - Pin](#)
 - [GraphicsBuilder - Shapes - Polygon](#)
 - [GraphicsBuilder - Shapes - Rays](#)
 - [GraphicsBuilder - Shapes - Rect](#)
 - [GraphicsBuilder - Shapes - RegularPolygon](#)
 - [GraphicsBuilder - Shapes - RoundRect](#)
 - [GraphicsBuilder - Shapes - Star](#)
 - [GraphicsBuilder - Shapes - Text](#)
 - [GraphicsBuilder - Shapes - Triangle](#)
 - [GraphicsBuilder - Shapes - Xpath](#)
- [GraphicsBuilder - Strokes](#)
 - [GraphicsBuilder - Strokes - BasicStroke](#)
 - [GraphicsBuilder - Strokes - CompositeStroke](#)
 - [GraphicsBuilder - Strokes - CompoundStroke](#)
 - [GraphicsBuilder - Strokes - Shapetroke](#)
 - [GraphicsBuilder - Strokes - Stroke](#)
 - [GraphicsBuilder - Strokes - TextStroke](#)
 - [GraphicsBuilder - Strokes - WobbleStroke](#)
 - [GraphicsBuilder - Strokes - ZigzagStroke](#)
- [Graphicsbuilder - SVG](#)
- [GraphicsBuilder - Swing](#)
- [GraphicsBuilder - Transformations](#)

Update: all graphics operation support binding in the same way as [SwingBuilder](#) does.

Developers

Andres Almiray

Source Control

<http://svn.codehaus.org/groovy-contrib/graphicsbuilder>

Building

GraphicsBuilder uses Maven2 as its build tool, which means that if you want to build your own version from source you'll need to have it installed. Follow the instructions at <http://maven.apache.org>.

Make sure to use maven 2.0.7 or higher.

Have fun!

Contributing

Please contact the team members by e-mail or use the mailing lists =)

Community

Mailing List(s)

<http://groovy.codehaus.org/Mailing+Lists>

Issue tracker

<http://jira.codehaus.org/secure/BrowseProject.jspx?id=10242>

GraphicsBuilder - Animation

This page last changed on Dec 29, 2007 by [aalmiray](#).

animate

[bind](#)

GraphicsBuilder - Animation - Bind

This page last changed on Dec 29, 2007 by [aalmiray](#).

Bind currently follows the same rules as [SwingBuilder.bind](#).

GraphicsBuilder - GDK

This page last changed on Jan 10, 2008 by [aalmiray](#).

GraphicsBuilder provides new methods for existing Java2D classes.

java.awt.Color

Color derive (Map)	creates a new color based on this color. Map must contain any of [red,green,blue,alpha]
-----------------------------	--

java.awt.BasicStroke

BasicStroke derive (Map)	creates a new stroke based on this stroke. Map must contain any of [width, cap, join, miterlimit, dash, dashphase]
-----------------------------------	--

java.awt.Shape

Area plus (Shape)	applies Area.add	enables + operator
Area minus (Shape)	applies Area.subtract	enables - operator
Area and (Shape)	applies Area.intersect	enables & operator
Area xor (Shape)	applies Area.xor	enables ^ operator

Note: [shapes](#) also have these 4 operators enabled

GraphicsBuilder - Goodles

This page last changed on Mar 29, 2008 by [aalmiray](#).

Goodles are Groovy's version of [Joshua Marinacci's doodles](#)

- Goodle #1 - MouseEnter/MouseExit triggered animations [[v1](#) | [v2](#)] [[code](#)] [[screencast](#)]
- Goodle #2 - Custom shape and opacity triggers [[v1](#)] [[code](#)] [[screencast](#)]
- Goodle #3 - Drag&Drop [[v1](#)] [[code](#)] [[screencast](#)]

GraphicsBuilder - Groodle1 - Screencast

This page last changed on Mar 29, 2008 by aalmiray.

[groodle1.swf](#)

```
import groovy.swing.SwingBuilder
import groovy.swing.j2d.GraphicsBuilder
import groovy.swing.j2d.GraphicsPanel

def gb = new GraphicsBuilder()

def go = gb.group {
def foreground = color(r:1,g:1)
def background = color('black')
(0..9).each { i ->
(0..19).each { j ->
def cell = "c_${i}_${j}"
rect( x:20*j, y:20*i, w: 20, h: 20, bc: background,
f: animate( [foreground,background],
startValue: background,
duration: 5000, start: false,
id: "$cell" ),
mouseEntered: {e ->
gb."$cell".restart()
}
)
}
}
}

def swing = SwingBuilder.build {
frame( title: "Groodles", size: [410,230],
locationRelativeTo: null, show: true ){
panel( new GraphicsPanel(), graphicsOperation: go )
}
}
```

GraphicsBuilder - Groodle2 - Screencast

This page last changed on Mar 29, 2008 by [aalmiray](#).

[groodle2.swf](#)

```
import groovy.swing.SwingBuilder
import groovy.swing.j2d.GraphicsBuilder
import groovy.swing.j2d.GraphicsPanel

def gb = new GraphicsBuilder()

def go = gb.group {
  antialias on
  balloon( x:20, y:20, w:100, bw:2, bc: 'black', arc: 10,
  tabWidth:animate(0..20, duration:300, start:no,id:'at',startDelay:1000),
  height: animate(0..100,duration:1000,start:no,id:'ah'),
  arc:    animate(0..10, duration:1000,start:no,id:'aa'),
  opacity:animate(0f..1f,duration:1000,start:no,id:'o') ){
  // let's use a multipaint to fill the shape
  multiPaint {
    // base color
    colorPaint( 'blue' )
    // highlights
    linearGradient( x2: 0, y2:50 ){
      stop( s: 0, c: color('white').derive(a:0.75) )
      stop( s: 0.66, c: color('white').derive(a:0) )
    }
  }
}

// this group is the ballon popup
group( o: 0, id: 'popup', f: 'blue', bc: no ){
  balloon( x:140, y: 40, w: 80, h: 60, tabWidth: 16, arc: 10,
  f: 'white', bc: 'black', bw: 2 )
  font( size: 20, style: 'bold' )
  text( x: 158, y: 50, text: 'Click' )
  text( x: 164, y: 70, text: 'me!' )
}

def normal = color('red')
def highlight = color('white')
def pressed = color('green')

// animation trigger
star( cx: 180, cy: 130, f: normal, or: 15, ir: 8, id: 'star',
mousePressed: {e ->
  star.fill = pressed
  at.restart()
  ah.restart()
  aa.restart()
  o.restart()
},
mouseReleased: {e-> star.fill = highlight},
mouseEntered: {e->
  star.fill = highlight
  popup.opacity = 1
},
mouseExited: {e->
  star.fill = normal
  popup.opacity = 0
})
}

def swing = SwingBuilder.build {
  frame( title: "Groodle #2", size: [240,200],
```



```
locationRelativeTo: null, show: true ){  
panel( new GraphicsPanel(), graphicsOperation: go )  
}  
}
```

GraphicsBuilder - Groodle3 - Screenshot

This page last changed on Mar 29, 2008 by [aalmiray](#).

[groodle3.swf](#)

 graphicsbuilder 0.6-SNAPSHOT is required to run this example

```
import groovy.swing.SwingBuilder
import groovy.swing.j2d.*

def gr = new GraphicsRenderer()
def gb = gr.gb

def go = gb.group {
def width = 150
def height = 150
def cx = width/2 + 10
def cy = height/2 + 10

antialias on
group( name: "frogface" ){
circle( cx: cx, cy: cy, r: width/2, bc: no ){
multiPaint {
colorPaint( color('green') )
radialGradient( cx: cx, cy: cy, r: width/2 ) {
stop( s: 0, c: color(r: 6, g: 160, b: 76, a: 127) )
stop( s: 1, c: color(a: 204) )
}
radialGradient( cx: cx, cy: cy,
fx: 55, fy: 35, r: width/1.4 ){
stop( s: 0, c: color('white').derive(a:0.5) )
stop( s: 0.5, c: color('white').derive(a:0) )
}
}
}

// left eye
circle( cx: 40, cy: 50, r: 20, bc: 'black', f: 'white' )
circle( cx: 43, cy: 53, r: 12, bc: 'none', f: 'black' )

// right eye
circle( cx: 130, cy: 50, r: 20, bc: 'black', f: 'white' )
circle( cx: 127, cy: 53, r: 12, bc: 'none', f: 'black' )

// nostrils
circle( cx: 75, cy: 80, r: 4, bc: 'black', f: 'black' )
circle( cx: 95, cy: 80, r: 4, bc: 'black', f: 'black' )

// mouth
ellipse( cx: 85, cy: 120, rx: 30, ry: 10, bc: 'black', f: 'black' ){
transformations { rotate( x: 85, y: 120, angle: -10 ) }
}

transformations {
translate( x: 250, y: 60 )
}
}

// eye patch
add( bc: 'black', f: 'black', id: 'eyepatch', autoDrag: yes ) {
rect( x: 10, y: 55, w: 150, h: 12 )
circle( cx: 40, cy: 80, r: 20 )
filters { dropShadow( name: 'shadow', enabled: no ) }
}
```

```

// goatee
triangle( x: 60, y: 210, w: 40, angle: 180, f: 'brown', id: 'goatee',
autoDrag: yes ){
filters { dropShadow( name: 'shadow', enabled: no ) }
}

// moustache
add( f: 'brown', id: 'moustache', autoDrag: yes ){
ellipse( cx: 65, cy: 140, rx: 25, ry: 8 ){
transformations { rotate( x: 65, y: 140, angle: -12 ) }
}
ellipse( cx: 105, cy: 140, rx: 25, ry: 8 ){
transformations { rotate( x: 105, y: 140, angle: 12 ) }
}
filters { dropShadow( name: 'shadow', enabled: no ) }
}

// hat
add( f: 'orange', id: 'hat', autoDrag: yes ){
triangle( x: 70, y: 230, w: 140, h: 40 )
rect( x: 100, y: 180, w: 80, h: 40 )
filters {
shapeBurst( merge: true, type: 'up' ){
linearColormap( color1: color('orange').darker(), color2: 'orange' )
}
lights()
dropShadow( name: 'shadow', enabled: no )
}
}

swingView {
button( 'Reset', x: 5, y: 5, actionPerformed: {e ->
['eyepatch','goatee','moustache','hat'].each {
gb."$it".txs.clear()
}
})
}

}

def startDrag = { e ->
def shape = e.target
shape.borderWidth = 3
shape.borderColor = 'red'
shape.filters['shadow'].enabled = true
}
def endDrag = { e ->
def shape = e.target
shape.borderWidth = 1
shape.borderColor = 'black'
shape.filters['shadow'].enabled = false
}

['eyepatch','goatee','moustache','hat'].each {
def shape = gb."$it"
shape.mousePressed = startDrag
shape.mouseReleased = endDrag
shape.mouseExited = endDrag
}

def swing = SwingBuilder.build {
frame( title: 'Groodle #3', size: [500,320],
locationRelativeTo: null, show: true ){
panel( new GraphicsPanel(), graphicsOperation: go )
}
}
}

```

GraphicsBuilder - Groups

This page last changed on Dec 29, 2007 by [aalmiray](#).

Groups are useful for arranging different operations in a single set. Groups may also define the following properties that can be overridden by any nested operation:

- `borderColor`: defines the color of the shape's outline
- `borderWidth`: defines the thickness of the shape's outline
- `fill`: defines the color, paint or gradient to fill the shape's content
- `opacity`: controls how much of the group is visible, value must be in the range [0..1], default is 1.

Examples

Borders and fill are passed to each children.

```
group( color: 'blue', strokeWidth: 4, fill: 'cyan' ){  
  rect( x: 10, y: 10, width: 290, height: 80, arcWidth: 20, arcHeight: 20 )  
  circle( cx: 90, cy: 80, radius: 50 )  
  polygon(points: [175, 38, 229, 69, 229, 131, 175, 162, 121, 131, 121, 69])  
}
```

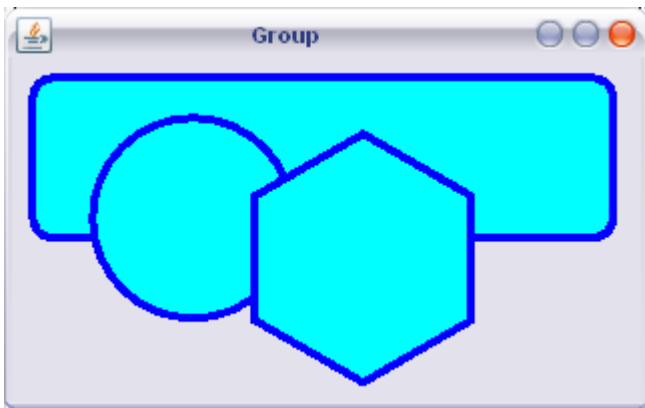

Border and fill is overridden by one child.

```
group( color: 'blue', strokeWidth: 4, fill: 'cyan' ){  
  rect( x: 10, y: 10, width: 290, height: 80, arcWidth: 20, arcHeight: 20 )  
  circle( cx: 90, cy: 80, radius: 50, borderColor: 'darkRed', fill: 'red' )  
  polygon(points: [175, 38, 229, 69, 229, 131, 175, 162, 121, 131, 121, 69])  
}
```

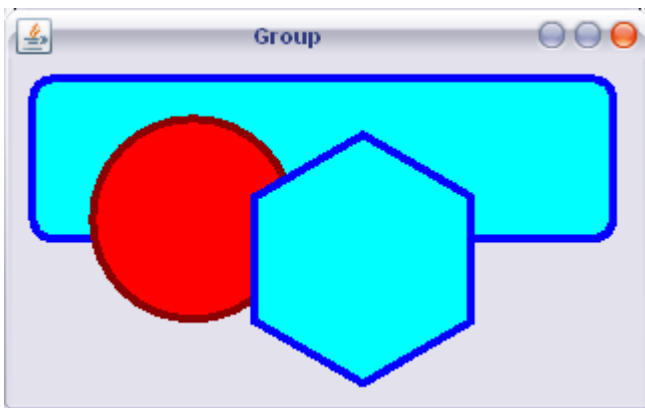

GraphicsBuilder - Misc

This page last changed on Jan 10, 2008 by [aalmiray](#).

[Antialias](#)

[Clip](#)

[Color](#)

[Draw](#)

[Font](#)

[Image](#)

[RenderingHint](#)

GraphicsBuilder - Misc - Antialias

This page last changed on Jan 10, 2008 by [aalmiray](#).

Enables or disables antialiasing. This is a shortcut for [renderingHint](#) as antialiasing is a very common option.

The long way is

```
renderingHints( key: 'antialiasing', value: 'antialias on' )
```

It accepts the following values [false, true, 'off', 'on']

GraphicsBuilder - Misc - Clip

This page last changed on Dec 29, 2007 by [aalmiray](#).

Sets the current clip to an specified [shape](#). It accepts [transformations](#) too.

Properties

Property	Default	Notes
shape		a shape or a java.awt.Shape

GraphicsBuilder - Misc - Color

This page last changed on Dec 29, 2007 by [aalmiray](#).

Creates a java.awt.Color based on the set of properties specified.

Properties

Property	Default	Notes
red	0	
green	0	
blue	0	
alpha	255	

You can wrap a color literal like 'white' or 'darkGreen' and get the corresponding java.awt.Color

GraphicsBuilder - Misc - Draw

This page last changed on Jan 11, 2008 by [aalmiray](#).

Renders [shapes](#) and [outlines](#). It is useful when reusing a previous saved shape/outline marked with `asShape=true` for example. It accepts [transformations](#), [paints](#) and all the properties of shapes/outlines, though it won't modify the original shape/outline. Draw will automatically translate the shape to the world origin (0,0).

Properties

Property	Default	Notes
shape		a shape , an outline or a <code>java.awt.Shape</code>

GraphicsBuilder - Misc - Font

This page last changed on Dec 29, 2007 by [aalmiray](#).

Creates a java.awt.Font based on the specified properties.

Properties

Property	Default	Notes
face		
style	<code>Font.PLAIN</code>	any combination of Font. [PLAIN,BOLD,ITALIC] or a separated string of [plain,bold,italic]
size	<code>12</code>	

GraphicsBuilder - Misc - Image

This page last changed on Dec 29, 2007 by [aalmiray](#).

Draws an image. An Image operation can work as a wrapper for another image operation, in the same way that [paint](#) works. It also accepts [transformations](#).

Properties

Property	Default	Notes
x	0	
y	0	
image		must be a java.awt.Image, an image or shape operation
classpath		String
url		URL or String
file		File or String
opacity	1	controls how much of the image is visible, value must be in the range [0..1]
asImage	false	if true will skip drawing the image right away, useful for texture painting

You must specify at least any of [image,classpath,url,file]

Example

```
image( url: 'http://groovy.codehaus.org/download/attachments/1866/groovydukemed.jpg' )
```



GraphicsBuilder - Misc - RenderingHint

This page last changed on Dec 29, 2007 by [aalmiray](#).

Assigns hints to the Java2D pipeline useful for rendering.

Properties

Property	Default	Notes
key		
value		

Key may have any value of: ["antialiasing", "rendering", "dithering", "text antialiasing", "text lcd contrast", "fractionalmetrics", "interpolation", "alpha interpolation", "color rendering", "stroke control"]

Value may have any value of: ["antialias on", "antialias off", "antialias default", "render speed", "render quality", "render default", "dither disable", "dither enable", "dither default", "text antialias on", "text antialias off", "text antialias default", "text antialias gasp", "text antialias lcd hrgb", "text antialias lcd hbgr", "text antialias lcd vrgb", "text antialias lcd vbgr", "fractionalmetrics off", "fractionalmetrics on", "fractionalmetrics default", "interpolation nearest neighbor", "interpolation bilinear", "interpolation bicubic", "alpha interpolation speed", "alpha interpolation quality", "alpha interpolation default", "color render speed", "color render quality", "color render default", "stroke default", "stroke normalize", "stroke pure"]

GraphicsBuilder - Outlines

This page last changed on Dec 29, 2007 by [aalmiray](#).

All outlines support the following additional properties

- `borderColor`: defines the color of the shape's outline. If false, the outline will not be drawn.
- `borderWidth`: defines the thickness of the shape's outline
- `opacity`: controls how much of the outline is visible, value must be in the range [0..1], default is 1.
- `asShape`: creates the shape but does not render to the screen, useful for mixing complex shapes

Alphabetical List

[cubicCurve](#)

[line](#)

[polyline](#)

[quadCurve](#)

GraphicsBuilder - Outlines - CubicCurve

This page last changed on Dec 10, 2007 by aalmiray.

Draws a cubic parametric curve segment.

Properties

Property	Default	Notes
x1		
y1		
ctrlx1		
ctry1		
ctrlx2		
ctry2		
x2		
y2		

Example

```
cubicCurve( x1: 10, y1: 10, ctrlx1: 10, ctry1: 100, ctrlx2: 300, ctry2: 10, x2: 300, y2: 10, borderColor: 'blue', borderWidth: 10 )
```

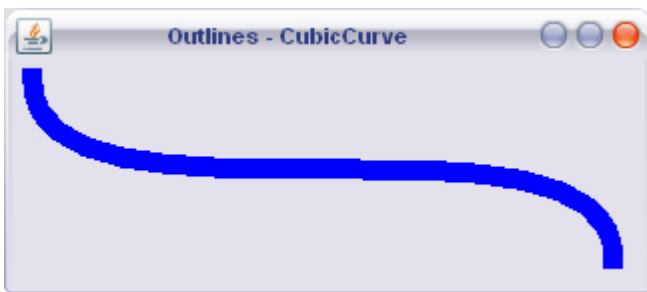

GraphicsBuilder - Outlines - Line

This page last changed on Dec 10, 2007 by [aalmiray](#).

Draws a line, using the current color, between the points (x1, y1) and (x2, y2).

Properties

Property	Default	Notes
x1	0	
x2	0	
y1	0	
y2	10	

Example

```
line( x1: 10, y1: 10, x2: 300, y2: 10, borderColor: 'black', borderWidth: 3 )  
line( x1: 10, y1: 20, x2: 300, y2: 40, borderColor: 'red', borderWidth: 3 )  
line( x1: 10, y1: 40, x2: 300, y2: 20, borderColor: 'blue', borderWidth: 3 )  
line( x1: 10, y1: 50, x2: 300, y2: 50, borderColor: 'black', borderWidth: 3 )
```

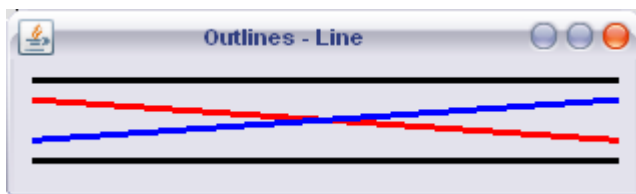

GraphicsBuilder - Outlines - Polyline

This page last changed on Dec 10, 2007 by [aalmiray](#).

Draws a sequence of connected lines defined by arrays of x and y coordinates.

Properties

Property	Default	Notes
points		An even list of points

Example

```
polyline( points: [60, 100, 110, 100, 100, 10, 80, 10, 80, 30, 90, 30], borderColor: 'black',  
borderWidth: 5 )
```

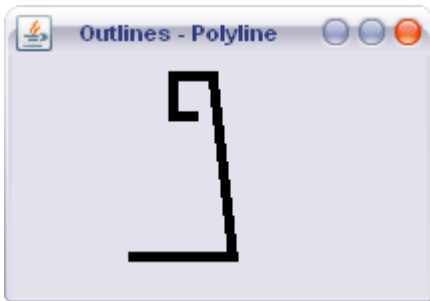

GraphicsBuilder - Outlines - QuadCurve

This page last changed on Dec 10, 2007 by aalmiray.

Draws a quadratic parametric curve segment.

Properties

Property	Default	Notes
x1		
y1		
ctrlx		
ctry		
x2		
y2		

Example

```
quadCurve( x1: 20, y1: 20, ctrlx: 300, ctrly: 60, x2: 20, y2: 100, borderColor: 'red', borderWidth: 4 )
```

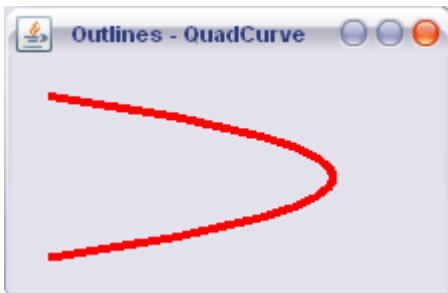

GraphicsBuilder - Paints

This page last changed on Jan 10, 2008 by [aalmiray](#).

Paints define how color patterns can be applied to a [Shape](#)'s contents either passing them as a parameter on `fill` or nesting them inside a [Shape](#) definition.

All paints support the following additional properties

- `asPaint`: creates the paint but does not apply it to the current context, useful for reusing paints in several shapes.

Alphabetical list

[BorderPaint](#)

[ColorPaint](#)

[GradientPaint](#)

[LinearGradient](#)

[Paint](#)

[RadialGradient](#)

[TexturePaint](#)

Extras

[MultiPaint](#)

GraphicsBuilder - Paints - BorderPaint

This page last changed on Jan 11, 2008 by [aalmiray](#).

Creates a paint suitable for a [shapes's](#) border only. Can not be nested in [multiPaint](#) or [paint](#).

GraphicsBuilder - Paints - ColorPaint

This page last changed on Jan 11, 2008 by [aalmiray](#).

Creates a color-based paint.

Properties

Property	Default	Notes
color		
red	0	
green	0	
blue	0	
alpha	255	

GraphicsBuilder - Paints - GradientPaint

This page last changed on Dec 21, 2007 by [aalmiray](#).

Creates a linear gradient between 2 colors.

Properties

Property	Default	Notes
x1	0	
y1	0	
x2	100	
y2	0	
color1	'black'	
color2	'white'	
cycle	false	
stretch	false	Scales the gradient to fit the Shape's bounds
fit	true	Scales the gradient retaining the aspect ratio

Examples

4 rectangles, each one with a diagonal gradient

```
rect( x: 0, y: 0, width: 100, height: 100 ){
  gradientPaint( x1: 0, y1: 0, x2: 50, y2: 50 )
}
rect( x: 100, y: 0, width: 100, height: 100 ){
  gradientPaint( x1: 50, y1: 0, x2: 0, y2: 50 )
}
rect( x: 0, y: 100, width: 100, height: 100 ){
  gradientPaint( x1: 0, y1: 50, x2: 50, y2: 0 )
}
rect( x: 100, y: 100, width: 100, height: 100 ){
  gradientPaint( x1: 50, y1: 50, x2: 0, y2: 0 )
}
```

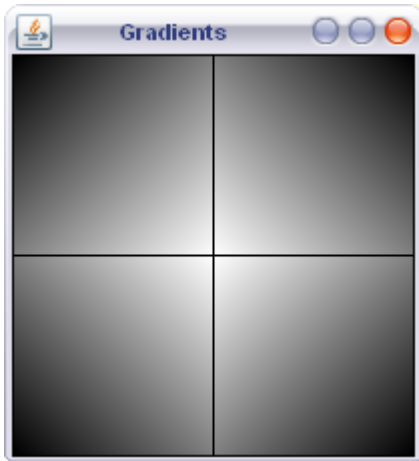

Different settings for fit, stretch and cycle

```
gradientPaint( id: 'g1', x1: 0, y1: 0, x2: 50, y2: 50 )
rect( x: 0, y: 0, width: 100, height: 100, fill: g1 )
circle( cx: 150, cy: 50, radius: 50, fill: g1 )
rect( x: 0, y: 100, width: 200, height: 100, fill: g1 )
```

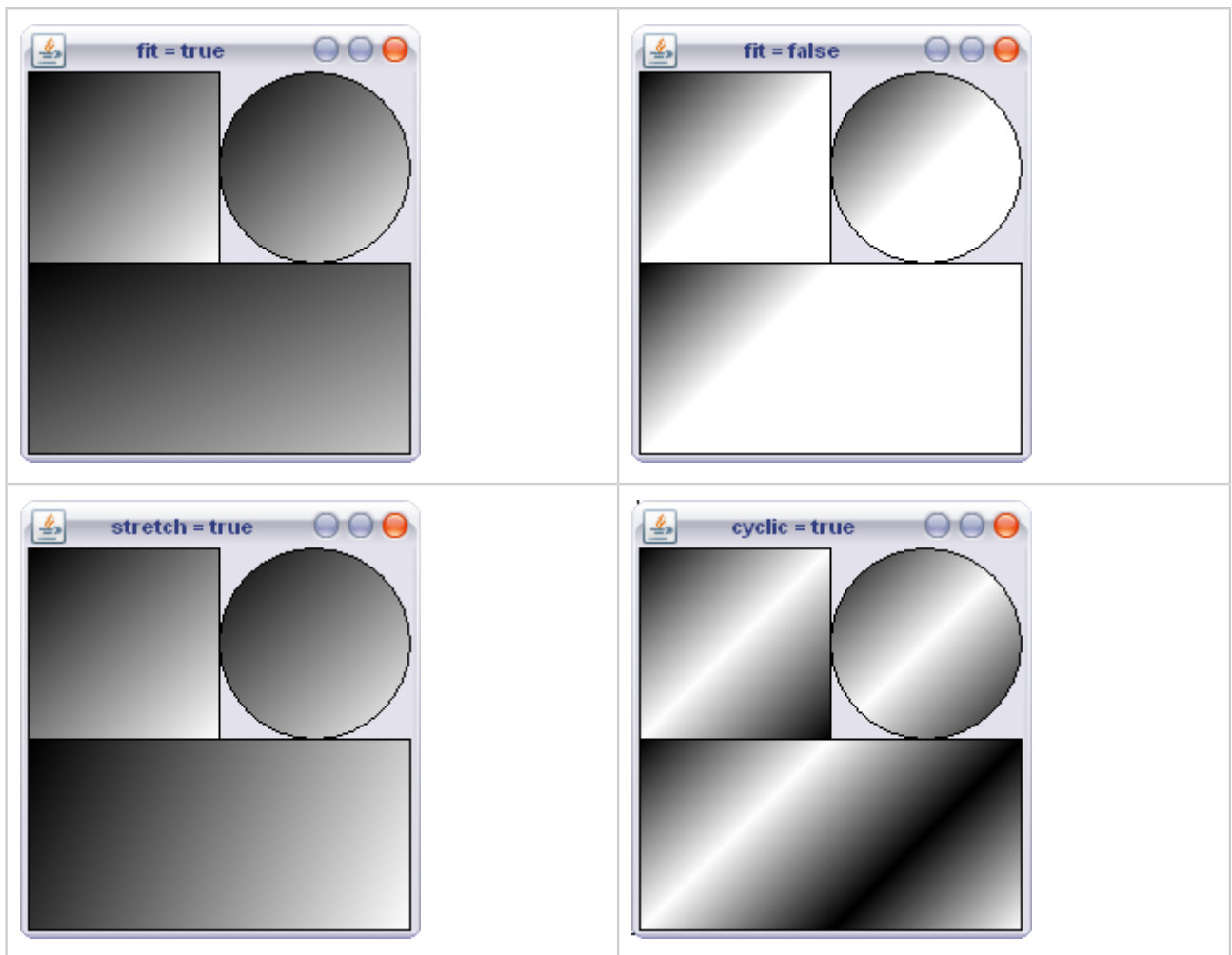

GraphicsBuilder - Paints - LinearGradient

This page last changed on Jan 11, 2008 by [aalmiray](#).

Creates a linear gradient of many colors.

Requires graphicsbuilder-ext-jdk6 and Java6+.

Properties

Property	Default	Notes
x1	0	
y1	0	
x2	100	
y2	0	
cycle	'nocycle'	value must be any of ['nocycle','reflect','repeat'] or any MultipleGradientPaint.CycleMethod
stretch	false	Scales the gradient to fit the Shape's bounds
fit	true	Scales the gradient retaining the aspect ratio
stops	[]	must define at least two stops
linkTo		a reference to a linearGradient or a radialGradient

If `linkTo` is used, then this gradient will reuse the referenced one's stops, new stops may be added to this gradient though.

Stops

Property	Default	Notes
offset		a float value in the range [0..1]
color		a Color or a color string
opacity		must be in the range [0..1]

Example

4 rectangles, each one with a diagonal gradient

```
def stops = {
def offsets = [0,0.5,1]
def colors = ['black','red','blue']
(0..2).each{ stop( offset: offsets[it], color: colors[it] ) }
}
rect( x: 0, y: 0, width: 100, height: 100 ){
linearGradient( x1: 0, y1: 0, x2: 50, y2: 50 ){ stops() }
}
```

```

rect( x: 100, y: 0, width: 100, height: 100 ){
linearGradient( x1: 50, y1: 0, x2: 0, y2: 50 ){ stops() }
}
rect( x: 0, y: 100, width: 100, height: 100 ){
linearGradient( x1: 0, y1: 50, x2: 50, y2: 0 ){ stops() }
}
rect( x: 100, y: 100, width: 100, height: 100 ){
linearGradient( x1: 50, y1: 50, x2: 0, y2: 0 ){ stops() }
}

```

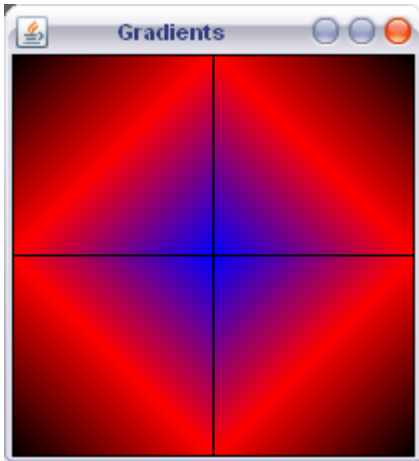

Different settings for fit, stretch and cycle

```

def stops = {
def offsets = [0,0.5,1]
def colors = ['black','red','blue']
(0..2).each{ stop( offset: offsets[it], color: colors[it] ) }
}
linearGradient( x1: 0, y1: 0, x2: 50, y2: 50, id: 'g1' ){ stops() }
rect( x: 0, y: 0, width: 100, height: 100, fill: g1 )
circle( cx: 150, cy: 50, radius: 50, fill: g1 )
rect( x: 0, y: 100, width: 200, height: 100, fill: g1 )

```

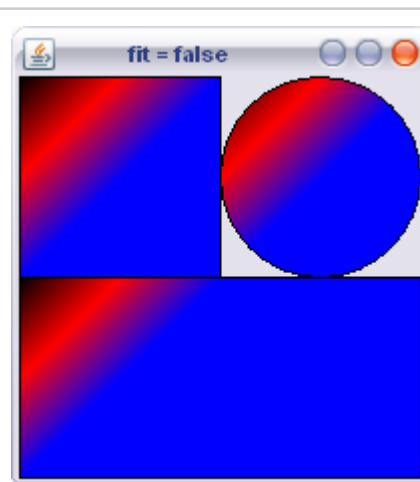
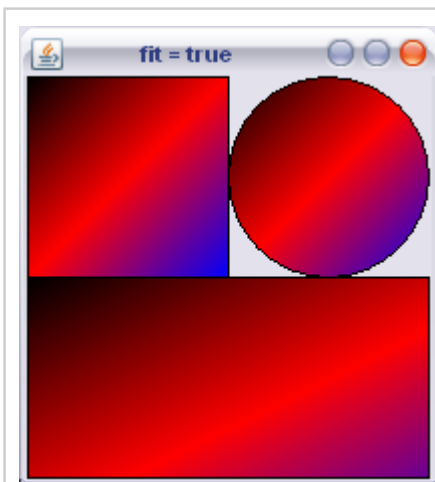

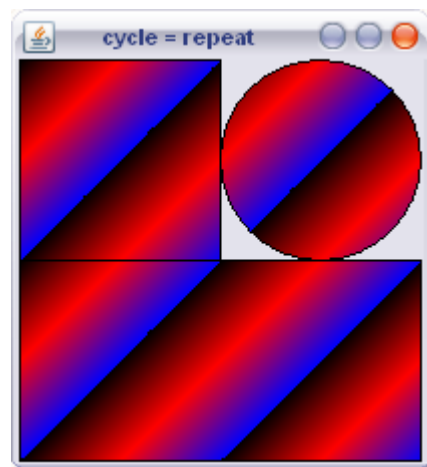
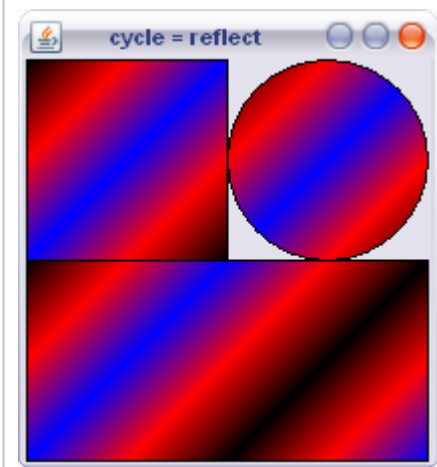
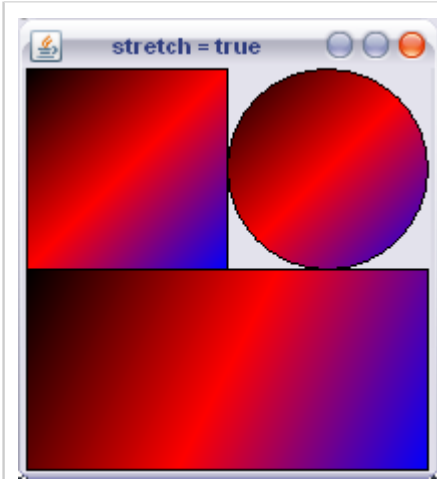

GraphicsBuilder - Paints - MultiPaint

This page last changed on Dec 29, 2007 by [aalmiray](#).

MultiPaints allow several [paints](#) to be applied to the same [shape](#).

Example

The following example is taken from chapter 7 of [Filthy Rich Clients](#) where 3 gradients are applied to a circle in order to create the illusion of a sphere

```
def width = 200
def height = 200
renderingHint( key: 'antialiasing', value: 'antialias on' )
circle( cx: width/2, cy: height/2, radius: width/2, borderColor: false ){
multiPaint {
radialGradient( cx: width/2, cy: height/2, radius: width/2 ) {
stop( offset: 0, color: color( red: 6, green: 76, blue: 160, alpha: 127 ) )
stop( offset: 1, color: color( alpha: 204 ) )
}
def lighting = color( red: 64, green: 142, blue: 203, alpha: 255 )
radialGradient( cx: width/2, cy: height*1.5,
fx: width/2, fy: (height*1.75)+6,
radius: width/2 ) {
stop( offset: 0, color: lighting )
stop( offset: 0.8, color: lighting.derive( alpha: 0 ) )
transformations{ scale( y: 0.5 ) }
}
radialGradient( cx: width/2, cy: height/2,
fx: 45, fy: 25, radius: width/1.4 ){
stop( offset: 0, color: color( 'white' ).derive( alpha: 0.4 ) )
stop( offset: 0.5, color: color( 'white' ).derive( alpha: 0 ) )
}
}
}
```

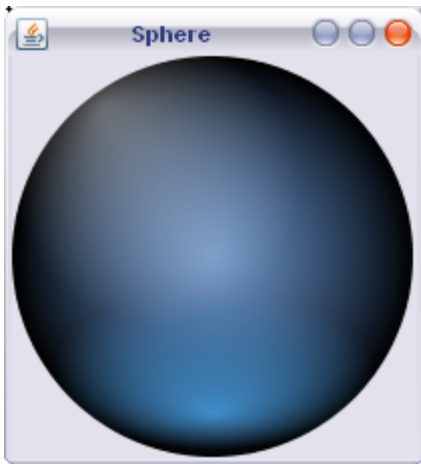

GraphicsBuilder - Paints - Paint

This page last changed on Dec 21, 2007 by [aalmiray](#).

Paint is a placeholder for other paints as gradients and textures. It allows setting new values on the wrapped paint, thus enabling paint reuse.

Properties

Property	Default	Notes
paint		must be a PaintProvider (all paints in GraphicsBuilder are PaintProviders)

Example

```
linearGradient( x1: 0, y1: 0, x2: 100, y2: 0, asPaint: true, id: 'g' ){
stop( offset: 0, color: 'black' )
stop( offset: 0.1, color: 'darkGreen' )
stop( offset: 0.9, color: 'orange' )
stop( offset: 1, color: 'black' )
}
rect( width: 100, height: 100, asShape: true, id: 'r1' )
rect( x: 110, width: 100, height: 100, asShape: true, id: 'r2' )
rect( y: 110, width: 210, height: 100, asShape: true, id: 'r3' )

// 3 rectangles as a single shape
add( borderColor: 'black', fill: g ) {
shape( r1 )
shape( r2 )
shape( r3 )
}

// vertical rectangle
rect( x: 220, width: 80, height: 210 ){
paint( g, x2: 0, y2: 50 )
}

// horizontal rectangle
rect( y: 220, width: 300, height: 50 ){
paint( g, cycle: 'repeat' )
}
```

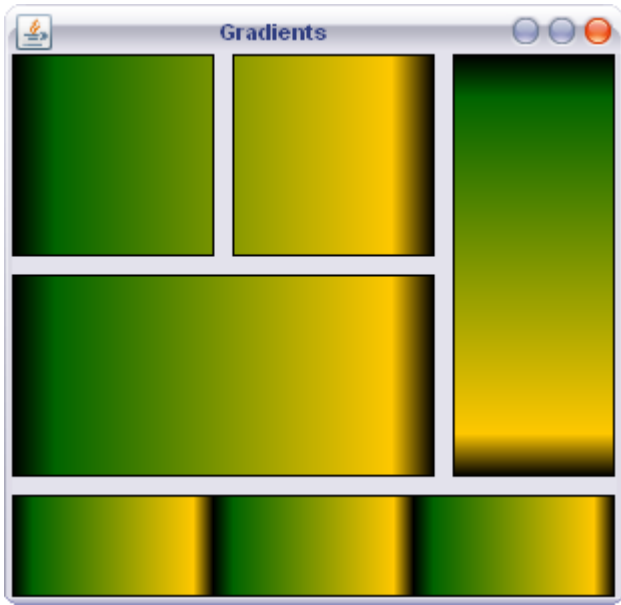

GraphicsBuilder - Paints - RadialGradient

This page last changed on Jan 11, 2008 by [aalmiray](#).

Creates a radial gradient of many colors. It accepts [transformations](#) too.

Requires graphicsbuilder-ext-jdk6 and Java6+.

Properties

Property	Default	Notes
cx		
cy		
fx		will take the value of cx if not defined
fy		will take the value of cy if not defined
radius		
absolute	false	flag for moving the center relative to the Shape or not
cycle	'nocycle'	value must be any of ['nocycle','reflect','repeat'] or any MultipleGradientPaint.CycleMethod
stops	[]	must define at least two stops
linkTo		a reference to a radialGradient or a linearGradient

If `linkTo` is used, then this gradient will reuse the referenced one's stops, new stops may be added to this gradient though.

Stops

Property	Default	Notes
offset		a float value in the range [0..1]
color		a Color or a color string
opacity		must be in the range [0..1]

Example

```
def stops = {
def offsets = [0,0.5,1]
def colors = ['black','red','blue']
(0..2).each{ stop( offset: offsets[it], color: colors[it] ) }
}
rect( x: 0, y: 0, width: 100, height: 100 ){
radialGradient( cx: 25, cy: 25, radius: 75 ){ stops() }
}
rect( x: 25, y: 100, width: 100, height: 100 ){
```

```
radialGradient( cx: 25, cy: 125, radius: 75, absolute: true ){ stops() }  
}
```

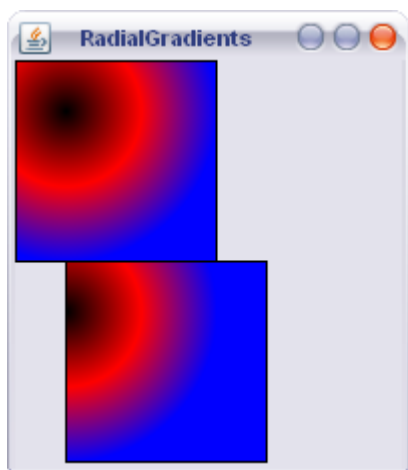

GraphicsBuilder - Paints - TexturePaint

This page last changed on Dec 29, 2007 by aalmiray.

Creates an image based paint. It is recommended that the image should have small dimensions as it will be tiled and copied to fit the Shape's bounds.

Properties

Property	Default	Notes
x	0	
y	0	
width		if specified will override the image's width
height		if specified will override the image's height
image		must be a java.awt.Image, an image or shape operation
classpath		String
url		URL or String
file		File or String

You must specify at least any of [image,classpath,url,file]

Example

```
rect( width: 200, height: 200, borderColor: false ){
  gradientPaint()
}
texturePaint( id: 'p', x: 0, y: 0, file: 'c:\\tmp\\groovy-logo.png' )
rect( x: 0, y: 0, width: 100, height: 100, borderColor: 'red', fill: p, )
circle( cx: 150, cy: 50, radius: 50, borderColor: 'red', fill: p )
rect( x: 0, y: 100, width: 200, height: 100, borderColor: 'red', fill: p )
```



```
renderingHint( key: 'antialiasing', value: 'antialias on' )
rect( width: 20, height: 20, borderColor: false, asShape: true, id: 'r' ){
  gradientPaint( y2: 50, color2: 'blue' )
```

```
transformations { rotate(angle:45) }  
}  
circle( cx: 125, cy: 125, radius: 70, asShape: true, id: 'c' )  
draw( shape: c ){  
gradientPaint( color2: 'red' )  
}  
rect( x:20, y: 20, width: 200, height: 200 ){  
texturePaint( image: r )  
}
```

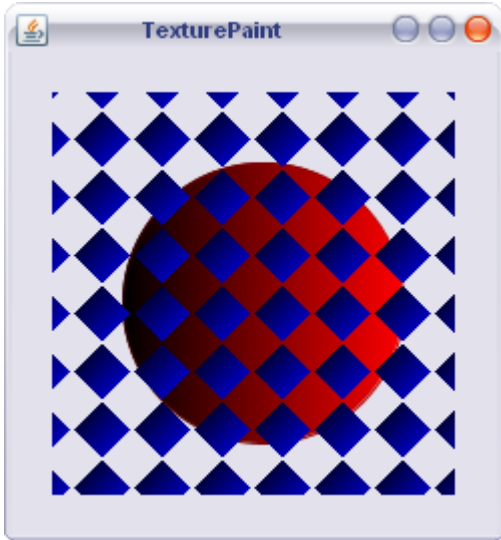

GraphicsBuilder - Shapes

This page last changed on Jan 10, 2008 by [aalmiray](#).

All shapes support the following additional properties

- `borderColor`: defines the color of the shape's outline. If false, the outline will not be drawn.
- `borderWidth`: defines the thickness of the shape's outline.
- `fill`: defines the color, [paint or gradient](#) to fill the shape's content.
- `opacity`: controls how much of the shape is visible, value must be in the range [0..1], default is 1.
- `asShape`: creates the shape but does not render to the screen, useful for mixing complex shapes.
- `asImage`: creates the shape but does not render to the screen, useful for drawing [images](#) or applying [textures](#).

Alphabetical list

[Arc](#)
[Arrow](#)
[Circle](#)
[Cross](#)
[Donut](#)
[Ellipse](#)
[Morph](#)
[Path](#)
[Pin](#)
[Polygon](#)
[Rays](#)
[Rect](#)
[RegularPolygon](#)
[RoundRect](#)
[Star](#)
[Text](#)
[Triangle](#)
[Xpath](#)

Areas

GraphicsBuilder can perform 4 area operations. All area operations require at least 2 shapes, and support additional shapes in the same operation.

[Add](#)
[Intersect](#)
[Subtract](#)
[Xor](#)
[Shape](#)

Events

All shapes may receive event notifications if the appropriate event handler is declared. The object passed as parameter to each handler is a `GraphicsInputEvent`, which wraps the original swing event, it has the following properties

<code>source</code>	the component where the event occurred, typically a <code>GraphicsPanel</code>
<code>event</code>	the wrapped event
<code>sourceShape</code>	the shape where the event was triggered

Event	Notes
-------	-------

mouseEntered	called when the mouse enters the bounds of a shape
mouseExited	called when the mouse exits the bounds of a shape
mouseClicked	called when the mouse is clicked within the bounds of a shape
mousePressed	called when the mouse is pressed within the bounds of a shape
mouseReleased	called when the mouse is released within the bounds of a shape
mouseMoved	called when the mouse is moved within the bounds of a shape
mouseDragged	called when the mouse is dragged within the bounds of a shape
mouseWheelMoved	called when the mouse's wheel is moved

GraphicsBuilder - Area - Add

This page last changed on Dec 10, 2007 by aalmiray.

Before

```
group( borderColor: 'blue', borderWidth: 4, fill: 'cyan' ){  
  rect( x: 10, y: 10, width: 290, height: 80, arcWidth: 20, arcHeight: 20 )  
  circle( cx: 90, cy: 80, radius: 50 )  
  polygon(points: [175, 38, 229, 69, 229, 131, 175, 162, 121, 131, 121, 69])  
}
```

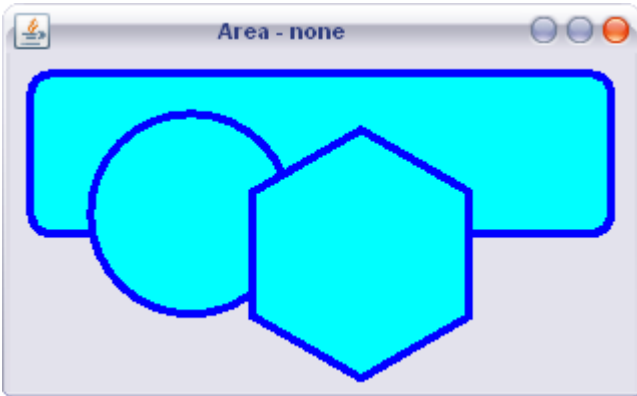

After

```
add( borderColor: 'blue', borderWidth: 4, fill: 'cyan' ){  
  rect( x: 10, y: 10, width: 290, height: 80, arcWidth: 20, arcHeight: 20 )  
  circle( cx: 90, cy: 80, radius: 50 )  
  polygon(points: [175, 38, 229, 69, 229, 131, 175, 162, 121, 131, 121, 69])  
}
```

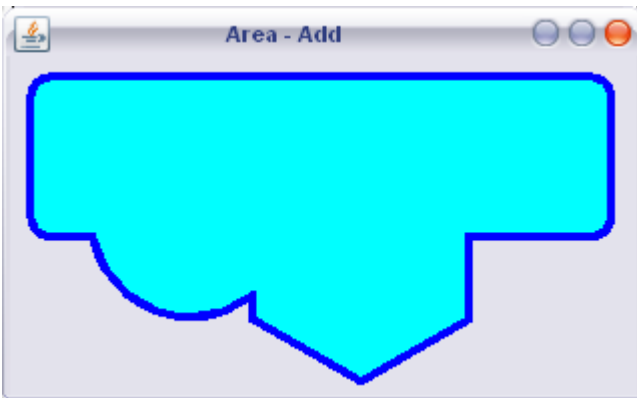

GraphicsBuilder - Area - Intersect

This page last changed on Dec 10, 2007 by aalmiray.

Before

```
group( borderColor: 'blue', borderWidth: 4, fill: 'cyan' ){  
  rect( x: 10, y: 10, width: 290, height: 80, arcWidth: 20, arcHeight: 20 )  
  circle( cx: 90, cy: 80, radius: 50 )  
  polygon(points: [175, 38, 229, 69, 229, 131, 175, 162, 121, 131, 121, 69])  
}
```

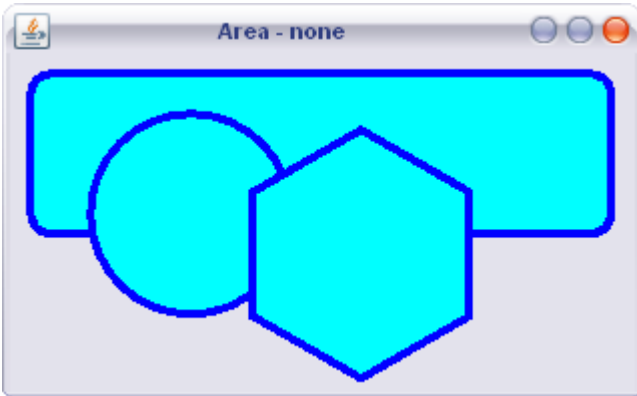

After

```
intersect( borderColor: 'blue', borderWidth: 4, fill: 'cyan' ){  
  rect( x: 10, y: 10, width: 290, height: 80, arcWidth: 20, arcHeight: 20 )  
  circle( cx: 90, cy: 80, radius: 50 )  
  polygon(points: [175, 38, 229, 69, 229, 131, 175, 162, 121, 131, 121, 69])  
}
```

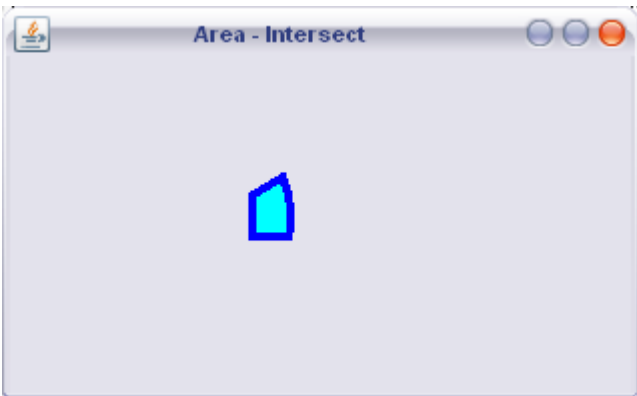

GraphicsBuilder - Area - Shape

This page last changed on Dec 21, 2007 by aalmiray.

Area.shape is a placeholder for any Shape operation, providing reuse of previously defined shapes. The following example is the same as [Add](#) but reuses 2 previously defined shapes.

Before

```
group( borderColor: 'blue', borderWidth: 4, fill: 'cyan' ){  
  rect( x: 10, y: 10, width: 290, height: 80, arcWidth: 20, arcHeight: 20 )  
  circle( cx: 90, cy: 80, radius: 50 )  
  polygon(points: [175, 38, 229, 69, 229, 131, 175, 162, 121, 131, 121, 69])  
}
```

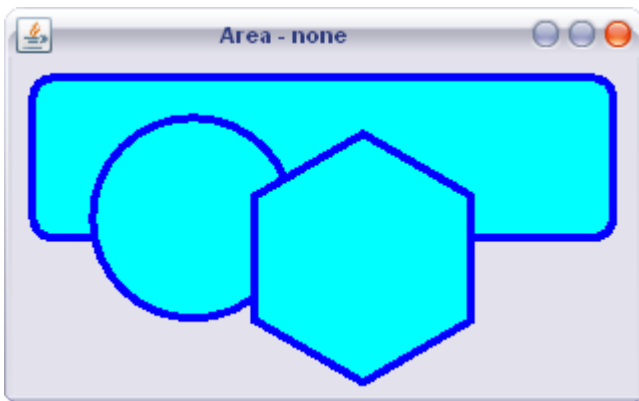

After

```
// note that the next two shapes have asShape=true and have an id set  
rect( x: 10, y: 10, width: 290, height: 80, arcWidth: 20, arcHeight: 20, asShape: true, id: 's1' )  
circle( cx: 90, cy: 80, radius: 50, asShape: true, id: 's2' )  
add( borderColor: 'blue', borderWidth: 4, fill: 'cyan' ){  
  shape( s1 )  
  shape( s2 )  
  polygon(points: [175, 38, 229, 69, 229, 131, 175, 162, 121, 131, 121, 69])  
}
```

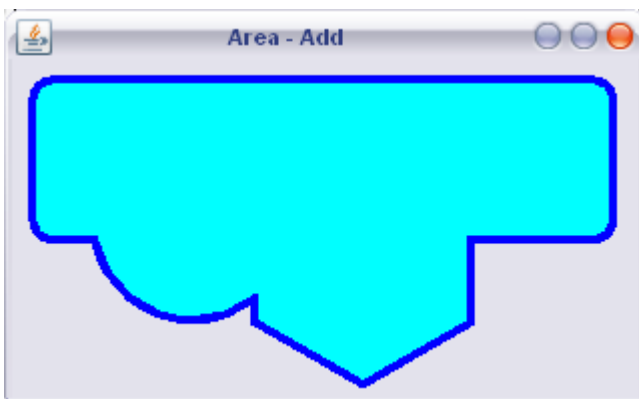

GraphicsBuilder - Area - Subtract

This page last changed on Dec 10, 2007 by aalmiray.

Before

```
group( borderColor: 'blue', borderWidth: 4, fill: 'cyan' ){  
  rect( x: 10, y: 10, width: 290, height: 80, arcWidth: 20, arcHeight: 20 )  
  circle( cx: 90, cy: 80, radius: 50 )  
  polygon(points: [175, 38, 229, 69, 229, 131, 175, 162, 121, 131, 121, 69])  
}
```

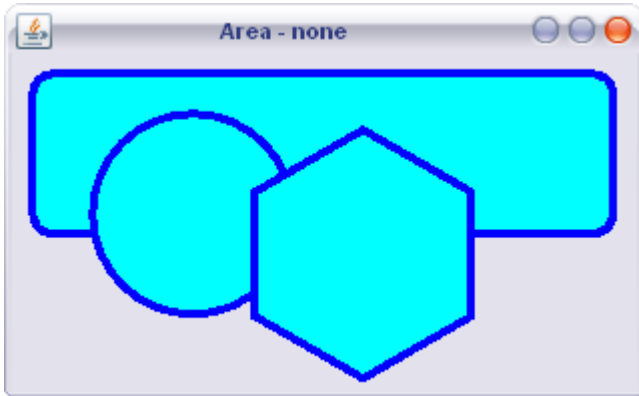

After

```
subtract( borderColor: 'blue', borderWidth: 4, fill: 'cyan' ){  
  rect( x: 10, y: 10, width: 290, height: 80, arcWidth: 20, arcHeight: 20 )  
  circle( cx: 90, cy: 80, radius: 50 )  
  polygon(points: [175, 38, 229, 69, 229, 131, 175, 162, 121, 131, 121, 69])  
}
```

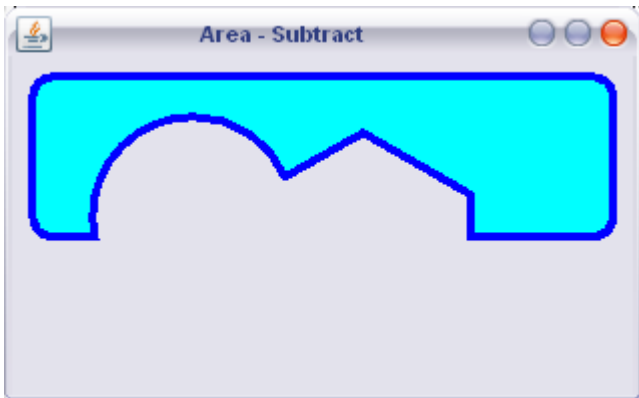

GraphicsBuilder - Area - Xor

This page last changed on Dec 10, 2007 by aalmiray.

Before

```
group( borderColor: 'blue', borderWidth: 4, fill: 'cyan' ){  
  rect( x: 10, y: 10, width: 290, height: 80, arcWidth: 20, arcHeight: 20 )  
  circle( cx: 90, cy: 80, radius: 50 )  
  polygon(points: [175, 38, 229, 69, 229, 131, 175, 162, 121, 131, 121, 69])  
}
```

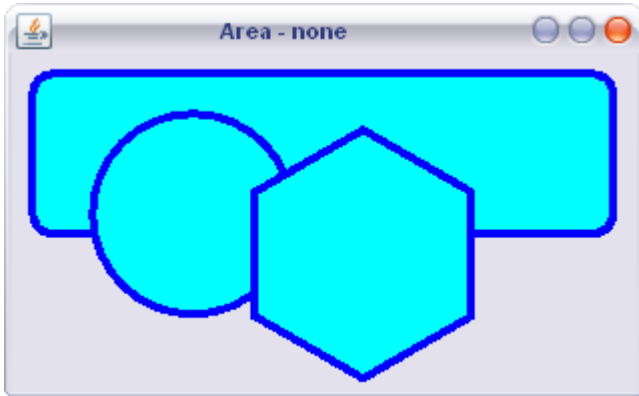

After

```
xor( borderColor: 'blue', borderWidth: 4, fill: 'cyan' ){  
  rect( x: 10, y: 10, width: 290, height: 80, arcWidth: 20, arcHeight: 20 )  
  circle( cx: 90, cy: 80, radius: 50 )  
  polygon(points: [175, 38, 229, 69, 229, 131, 175, 162, 121, 131, 121, 69])  
}
```

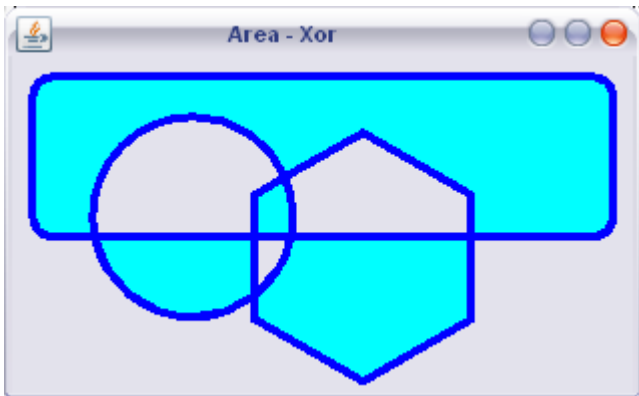

GraphicsBuilder - Shapes - Arc

This page last changed on Dec 10, 2007 by [aalmiray](#).

Draws an arc defined by a framing rectangle, start angle, angular extent (length of the arc), and a closure type (OPEN, CHORD, or PIE)

Properties

Property	Default	Notes
x	0	
y	0	
width	0	
height	0	
start	0	
extent	90	
close	Arc2D.OPEN	value must be any of Arc2D. [OPEN,CHORD,CLOSE] or ['open','chord','close']

Example

```
arc( x: 0, y: 20, width: 100, height: 100, start: 0, extent: 90,  
borderColor: 'darkViolet', borderWidth: 5, fill: 'pink', close: 'pie' )  
arc( x: 100, y: 20, width: 100, height: 100, start: 0, extent: 90,  
borderColor: 'darkViolet', borderWidth: 5, fill: 'pink', close: 'chord' )  
arc( x: 200, y: 20, width: 100, height: 100, start: 0, extent: 90,  
borderColor: 'darkViolet', borderWidth: 5, fill: 'pink', close: 'open' )
```

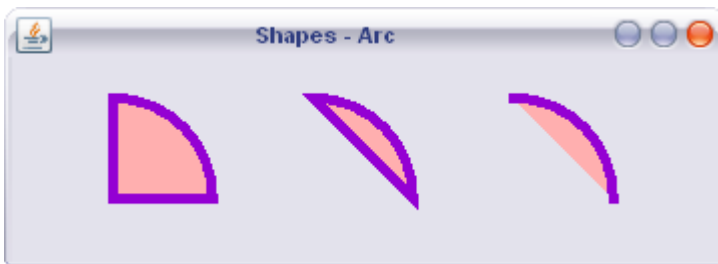

GraphicsBuilder - Shapes - Arrow

This page last changed on Jan 11, 2008 by [aalmiray](#).

Draws an arrow anchored at [x,y].

Properties

Property	Default	Notes
x	0	
y	0	
width	10	
height	6	
depth	0.5	must be in the range [0..1]
rise	0.5	must be in the range [0..1]
angle	0	

GraphicsBuilder - Shapes - Circle

This page last changed on Dec 10, 2007 by [aalmiray](#).

Draws a circle that is defined by a framing rectangle

Properties

Property	Default	Notes
cx	5	
cy	5	
radius	5	

Example

```
circle( cx: 80, cy: 80, radius: 50, borderColor: 'green', borderWidth:4, fill: 'yellow' )
```

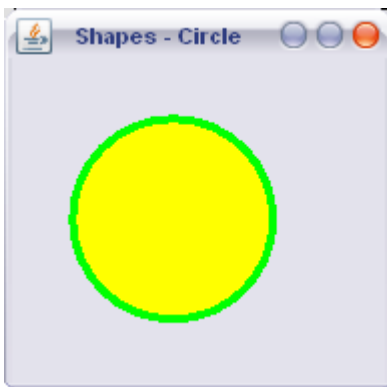

GraphicsBuilder - Shapes - Cross

This page last changed on Jan 11, 2008 by [aalmiray](#).

Draws a cross centered at [cx,cy].

Properties

Property	Default	Notes
cx	5	
cy	5	
radius	5	
width	$\text{radius} * 3 / 5$	
roundness	0	must be in the range [0..1]
angle	0	

GraphicsBuilder - Shapes - Donut

This page last changed on Jan 11, 2008 by [aalmiray](#).

Draws a donut-like shape centered at [cx,cy].

Properties

Property	Default	Notes
cx	20	
cy	20	
or	20	
ir	10	
sides		will use a regular polygon if set, a circle otherwise
angle	0	

GraphicsBuilder - Shapes - Ellipse

This page last changed on Dec 10, 2007 by [aalmiray](#).

Draws an ellipse that is defined by a framing rectangle.

Properties

Property	Default	Notes
cx	10	
cy	5	
radiusx	10	
radiusy	5	

Example

```
ellipse( cx: 120, cy: 80, radiusx: 100, radiusy: 50, borderColor: 'red', borderWidth: 3, fill: 'magenta' )
```

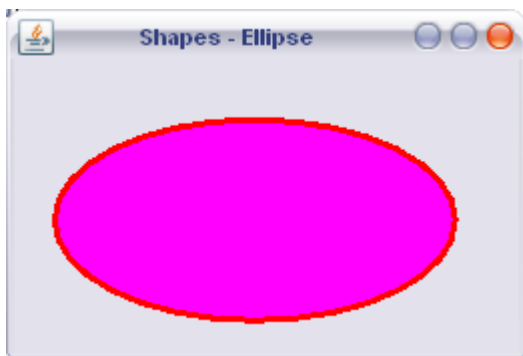

GraphicsBuilder - Shapes - Morph

This page last changed on Feb 02, 2008 by [aalmiray](#).

Draws a shape which geometry is constructed from two other shapes: a start shape and an end shape. The morph property of a morphing shape defines the amount of transformation applied to the start shape to turn it into the end shape. Both shapes must have the same winding rule.

Requires graphicsbuilder-ext-swingx and swingx in classpath.

Properties

Properties	DefaultValue	Notes
start		may be a java.awt.Shape or any shape operation
end		may be a java.awt.Shape or any shape operation
morph	0	float value in the range (0..1)

Example

```
def rect = rect( x: 20, y: 50, width: 100, height: 100, arcWidth: 20, arcHeight: 20, asShape: true)
def star = star( cx: 100, cy: 100, ir: 50, or: 80, count: 5, asShape: true )
morph( start: rect, end: star, morph: 0.1, borderWidth: 3, borderColor: 'orange', fill: 'yellow' )
morph( start: rect, end: star, morph: 0.8, borderWidth: 3, borderColor: 'blue', fill: 'cyan' ){
transformations { translate(x: 140, y: 0) }
}
```

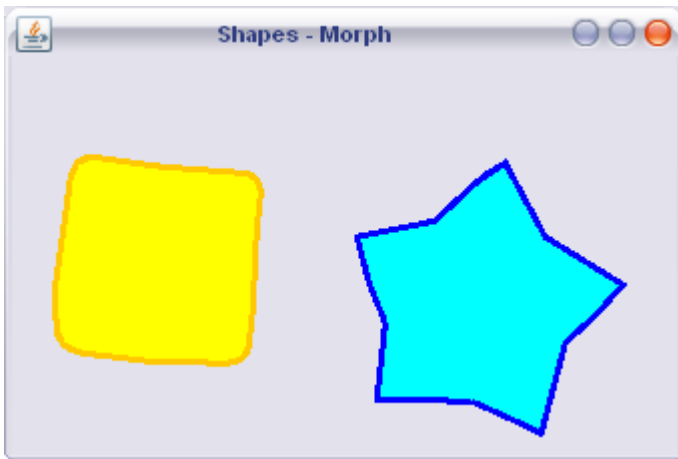

GraphicsBuilder - Shapes - Path

This page last changed on Dec 10, 2007 by [aalmiray](#).

Draws an arbitrary geometric path. Paths are described by a series of pathOperations:

Operation	Description
<code>moveTo[x,y]</code>	adds a point to the path by moving to the specified coordinates (x,y)
<code>lineTo[x,y]</code>	adds a point to the path by drawing a straight line from the current coordinates to the new specified coordinates (x,y)
<code>curveTo[x1,y1,x2,y2,x3,y3]</code>	adds a curved segment, defined by three new points, to the path by drawing a Bézier curve that intersects both the current coordinates and the specified coordinates (x3,y3), using the specified points (x1,y1) and (x2,y2) as Bézier control points
<code>quadTo[x1,y1,x2,y2]</code>	adds a curved segment, defined by two new points, to the path by drawing a Quadratic curve that intersects both the current coordinates and the specified coordinates (x2,y2), using the specified point (x1,y1) as a quadratic parametric control point
<code>hline[x]</code>	adds a point to the path by drawing an horizontal line to the specified coordinates (x,current.y)
<code>vline[y]</code>	adds a point to the path by drawing a vertical line to the specified coordinates (current.x,y)
<code>shapeTo[shape,connect]</code>	appends the geometry of the specified Shape, shape operation or outline operation to the path, possibly connecting the new geometry to the existing path segments with a line segment
<code>close</code>	closes the current subpath by drawing a straight line back to the coordinates of the last <code>moveTo</code>

The first operation must be a `moveTo`.

Example

```
path( borderColor: 'darkBlue', fill: 'blue', borderWidth: 4 ){
moveTo( x: 50, y: 50 )
quadTo( x1: -30, y1: 100, x2: 50, y2: 150 )
quadTo( x1: 100, y1: 230, x2: 150, y2: 150 )
quadTo( x1: 230, y1: 100, x2: 150, y2: 50 )
quadTo( x1: 100, y1: -30, x2: 50, y2: 50 )
}
```

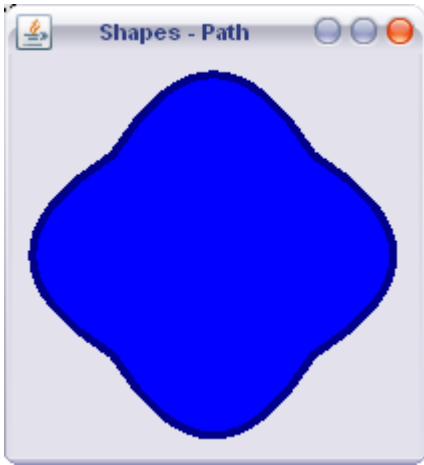

GraphicsBuilder - Shapes - Pin

This page last changed on Jan 11, 2008 by [aalmiray](#).

Draws a pin (like the ones used in webmaps) centered at [cx,cy].

Properties

Property	Default	Notes
cx	5	
cy	5	
radius	5	
height	<code>radius * 2</code>	
angle	0	

GraphicsBuilder - Shapes - Polygon

This page last changed on Dec 10, 2007 by [aalmiray](#).

Draws a closed, two-dimensional region within a coordinate space. This region is bounded by an arbitrary number of line segments, each of which is one side of the polygon. Internally, a polygon comprises of a list of (x,y) coordinate pairs, where each pair defines a vertex of the polygon, and two successive pairs are the endpoints of a line that is a side of the polygon. The first and final pairs of (x,y) points are joined by a line segment that closes the polygon.

Properties

Property	Default	Notes
points		An even list of points

Example

```
polygon( points: [175, 38, 229, 69, 229, 131, 175, 162, 121, 131, 121, 69],  
borderColor: 'green', borderWidth: 6, fill: 'white' )
```

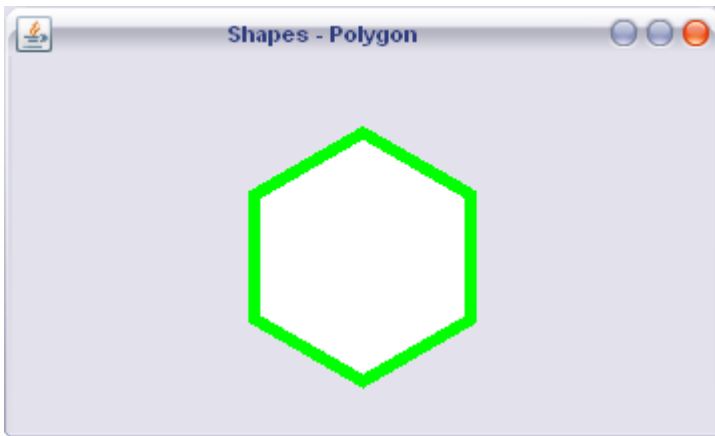

GraphicsBuilder - Shapes - Rays

This page last changed on Jan 11, 2008 by [aalmiray](#).

Draws a set of rays centered at [cx,cy].

Properties

Property	Default	Notes
cx	5	
cy	5	
radius	5	
rays	2	can not be less than 2
extent	0.5	must be in the range [0..1]
rounded	false	
angle	0	

GraphicsBuilder - Shapes - Rect

This page last changed on Dec 10, 2007 by [aalmiray](#).

Draws a rectangle defined by a location (x,y) and dimension (width x height). If arcWidth and arcHeight are defined then it will draw a rounded rectangle.

Properties

Property	Default	Notes
x	0	
y	0	
width	10	
height	10	
arcWidth		
arcHeight		

Examples

```
rect( x: 10, y: 10, width: 300, height: 80, borderColor: 'darkRed', borderWidth: 2, fill: 'red' )
```

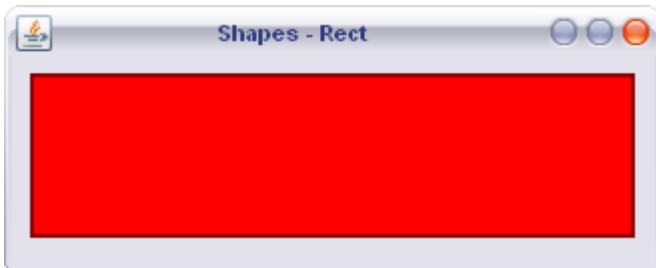

```
rect( x: 10, y: 10, width: 300, height: 80, borderColor: 'blue', borderWidth: 2, fill: 'cyan', arcWidth: 20, arcHeight: 20 )
```

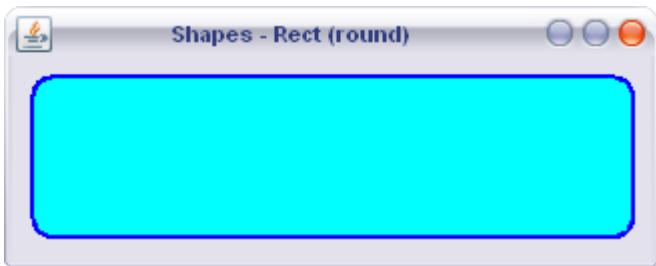

GraphicsBuilder - Shapes - RegularPolygon

This page last changed on Jan 11, 2008 by [aalmiray](#).

Draws a regular polygon centered at [cx,cy].

Properties

Property	Default	Notes
cx	5	
cy	5	
radius	5	
sides	3	can not be less than 3
angle	0	

GraphicsBuilder - Shapes - RoundRect

This page last changed on Jan 10, 2008 by [aalmiray](#).

Draws a rounded rectangle anchored at [x,y]. Each corner may have a different round setting.

Properties

GraphicsBuilder - Shapes - Star

This page last changed on Jan 11, 2008 by [aalmiray](#).

Draws a star shape. A star is defined by two radii and a number of branches. Each branch spans between the two radii. The inner radius is the distance between the center of the star and the origin of the branches. The outer radius is the distance between the center of the star and the tips of the branches.

Properties

Property	Default	Notes
cx	5	
cy	5	
ir	3	Can not be equal or bigger than or
or	8	Can not be equal or smaller than ir
count	5	Can not be less than 2
angle	0	

GraphicsBuilder - Shapes - Text

This page last changed on Dec 10, 2007 by [aalmiray](#).

Draws a string at the specified coordinates.

Properties

Property	Default	Notes
text	'Groovy'	
x	0	
y	0	

Example

```
font( face: "Helvetica", style: Font.ITALIC, size: 48 )  
text( text: 'Groovy rocks!', x: 20, y: 20, borderColor: 'darkGreen', fill: 'green' )
```



GraphicsBuilder - Shapes - Triangle

This page last changed on Jan 11, 2008 by [aalmiray](#).

Draws an equilateral, isosceles or right triangle anchored at [x,y].

Properties

Property	Default	Notes
x	0	
y	0	
width	10	
height		will draw an isosceles or a right triangle if set
rightAngleAt		will draw a right triangle if set, value must be any of [start,end]
rotateAtCenter		will rotate the triangle at its center instead of using (x,y) as anchor
angle	0	

GraphicsBuilder - Shapes - Xpath

This page last changed on Dec 10, 2007 by [aalmiray](#).

Draws an arbitrary geometric path. Paths are described by a series of pathOperations. Xpath is different to [path](#) because it uses the Batik library for rendering and adds a new operation: `xarcTo`

Operation	Description
<code>xmoveTo[x,y]</code>	adds a point to the path by moving to the specified coordinates (x,y)
<code>xlineTo[x,y]</code>	adds a point to the path by drawing a straight line from the current coordinates to the new specified coordinates (x,y)
<code>xcurveTo[x1,y1,x2,y2,x3,y3]</code>	adds a curved segment, defined by three new points, to the path by drawing a Bézier curve that intersects both the current coordinates and the specified coordinates (x3,y3), using the specified points (x1,y1) and (x2,y2) as Bézier control points
<code>xquadTo[x1,y1,x2,y2]</code>	adds a curved segment, defined by two new points, to the path by drawing a Quadratic curve that intersects both the current coordinates and the specified coordinates (x2,y2), using the specified point (x1,y1) as a quadratic parametric control point
<code>xhline[x]</code>	adds a point to the path by drawing an horizontal line to the specified coordinates (x,current.y)
<code>xvline[y]</code>	adds a point to the path by drawing a vertical line to the specified coordinates (current.x,y)
<code>xshapeTo[shape,connect]</code>	appends the geometry of the specified Shape, shape operation or outline operation to the path, possibly connecting the new geometry to the existing path segments with a line segment
<code>xclose</code>	closes the current subpath by drawing a straight line back to the coordinates of the last <code>moveTo</code>
<code>xarcTo[x,y,rx,ry,angle,sweep,largeArc]</code>	adds an elliptical arc, defined by two radii (rx,ry), an angle from the x-axis, a flag to choose the large arc or not, a flag to indicate if we increase or decrease the angles and the final point of the arc (x,y)

The first operation must be a `moveTo`.

Example

```
xpath( borderColor: 'darkRed', fill: 'red', borderWidth: 4 ){
xmoveTo( x: 50, y: 10 )
xhline( x: 200 )
xvline( y: 60 )
xarcTo( x: 50, y: 60, rx: 150, ry: 150, angle: 90, sweep: true, largeArc: false )
}
```

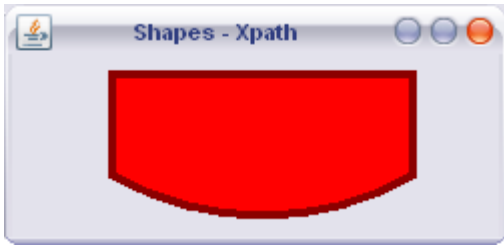

GraphicsBuilder - Strokes

This page last changed on Jan 10, 2008 by [aalmiray](#).

Strokes allow customization on [outlines](#) and a [shape's](#) border. Some of the provided strokes come from [Jerry Huxtable's stroke set](#)

[BasicStroke](#)

[CompositeStroke](#)

[CompoundStroke](#)

[Shapetroke](#)

[Stroke](#)

[TextStroke](#)

[WobbleStroke](#)

[ZigzagStroke](#)

GraphicsBuilder - Strokes - BasicStroke

This page last changed on Jan 10, 2008 by [aalmiray](#).

Creates a java.awt.BasicStroke used to draw the contour of [shapes](#) and [outlines](#).

Properties

Property	Default	Notes
width	1	
cap	'square'	any of [butt,round,square]
join	'miter'	any of [bevel,round,miter]
miterlimit	10	
dash		
dashphase	0	

GraphicsBuilder - Strokes - CompositeStroke

This page last changed on Jan 10, 2008 by [aalmiray](#).

Creates a stroke as a composite of two strokes, meaning that the second stroke will be used to draw the outline created by the first stroke.

Properties

Property	Default	Notes
stroke1		must be a java.awt.Stroke or a StrokeProvider
stroke2		must be a java.awt.Stroke or a StrokeProvider

This operation accepts nested [strokes](#), they will be applied in appearing order. If more than 2 strokes are nested only the first 2 will be taken into account.

GraphicsBuilder - Strokes - CompoundStroke

This page last changed on Jan 10, 2008 by [aalmiray](#).

Creates a stroke as a composite of two strokes using an Area operation.

Properties

Property	Default	Notes
stroke1		must be a java.awt.Stroke or a StrokeProvider
stroke2		must be a java.awt.Stroke or a StrokeProvider
operation	'add'	must be any of [add,subtract,intersect,xor]

This operation accepts nested [strokes](#), they will be applied in appearing order. If more than 2 strokes are nested only the first 2 will be taken into account.

GraphicsBuilder - Strokes - Shapetroke

This page last changed on Jan 11, 2008 by [aalmiray](#).

Creates a stroke that uses [shapes](#) to define the outline.

Properties

Property	Default	Notes
shapes	[]	a list of java.awt.Shape or shapes
advance	10	

This operation accepts nested [shapes](#) and [shape](#).

GraphicsBuilder - Strokes - Stroke

This page last changed on Jan 10, 2008 by [aalmiray](#).

Placeholder for previously defined strokes, works in the same way as [paint](#) does for [paints](#).

Properties

Property	Default	Notes
stroke		must be a java.awt.Stroke or a StrokeProvider

GraphicsBuilder - Strokes - TextStroke

This page last changed on Jan 11, 2008 by [aalmiray](#).

Creates a stroke that draws a text along the stroked outline.

Properties

Property	Default	Notes
text	'Groovy'	
font		
stretch	false	
repeat	false	

GraphicsBuilder - Strokes - WobbleStroke

This page last changed on Jan 11, 2008 by [aalmiray](#).

Creates a randomly generated outline with variable width.

Properties

Property	Default	Notes
detail	2	
amplitude	2	

GraphicsBuilder - Strokes - ZigzagStroke

This page last changed on Jan 11, 2008 by [aalmiray](#).

Creates a zig-zag like pattern for stroking an outline.

Properties

Property	Default	Notes
stroke		must be a java.awt.Stroke or a StrokeProvider
amplitude	10	
wavelength	10	

This operation accepts nested [strokes](#), they will be applied in appearing order. If more than 1 strokes are nested only the first will be taken into account.

Graphicsbuilder - SVG

This page last changed on Jan 10, 2008 by [aalmiray](#).

Pending

GraphicsBuilder - Swing

This page last changed on Dec 29, 2007 by [aalmiray](#).

Swing components can be embedded using the `swingView` node. It will use a fresh copy of `SwingBuilder`, but you can specify your own [SwingBuilder](#) instance or some other builder like [SwingXBuilder](#) or [JideBuilder](#).

Example

```
swingView {
panel( x: 10, y: 10 ) {
  GridLayout( cols: 1, rows: 4 )
  ['red','blue','green'].each { color ->
  button( label: color, foreground: color,
  actionPerformed: {e-> p1.color2 = color} )
  }
  button( label: 'reset', actionPerformed: {e-> p1.color2 = 'white'} )
  }
}

rect( x: 90, y: 10, width: 100, height: 100 ){
  GradientPaint( id: 'p1', y2: 50 )
}

line( x1: 10, x2: 190, y1: 125, y2: 125 ){
  stroke( width: 2, dash: [12,12], dashphase: 0 )
}

swingView {
panel( id: 'panel', x: 90, y: 140, preferredSize: [100,100],
opaque: true, background: 'white' )
}

def changeBackground = { shape ->
panel.background = ColorCache.getInstance().getColor(shape.fill) }
def borderOn = { e -> e.sourceShape.borderColor = 'black' }
def borderOff = { e -> e.sourceShape.borderColor = false }
rect( x: 10, y: 140, width: 60, height: 20, borderColor: false, fill: 'red',
mouseClicked: {e-> changeBackground(e.sourceShape)},
mouseenter: borderOn, mouseExited: borderOff )
rect( x: 10, y: 165, width: 60, height: 20, borderColor: false, fill: 'blue',
mouseClicked: {e-> changeBackground(e.sourceShape)},
mouseenter: borderOn, mouseExited: borderOff )
rect( x: 10, y: 190, width: 60, height: 20, borderColor: false, fill: 'green',
mouseClicked: {e-> changeBackground(e.sourceShape)},
mouseenter: borderOn, mouseExited: borderOff )
rect( x: 10, y: 215, width: 60, height: 20, borderColor: false, fill: 'white',
mouseClicked: {e-> changeBackground(e.sourceShape)},
mouseenter: borderOn, mouseExited: borderOff )
}
```

GraphicsBuilder - Transformations

This page last changed on Jan 10, 2008 by [aalmiray](#).

Transformations can be applied to [Shapes](#), [Outlines](#), [groups](#), [images](#) and [radialGradients](#). All operations can be combined in a single `transformations` block if needed.

When applied to [images](#), there is an extra property `interpolation` useful for giving hints, its value may be any of `[bicubic,bilinear,nearest]`.

Available operations

Matrix
Rotate
Scale
Skew
Translate

None

```
rect( x: 10, y: 10, width: 300, height: 80, arcWidth: 20, arcHeight: 20,  
borderColor: 'darkRed', borderWidth: 2, fill: 'red' )
```

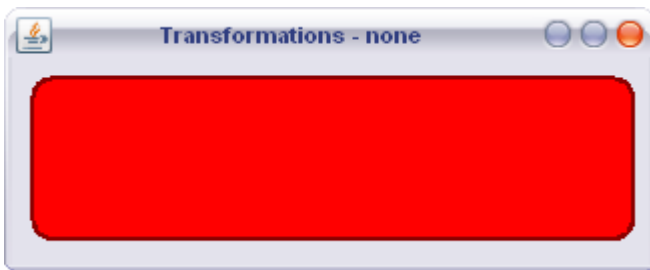

Translate

```
rect( x: 10, y: 10, width: 300, height: 80, arcWidth: 20, arcHeight: 20,  
borderColor: 'darkRed', borderWidth: 2, fill: 'red' ){  
transformations {  
translate( x: 50, y: 20 )  
}  
}
```

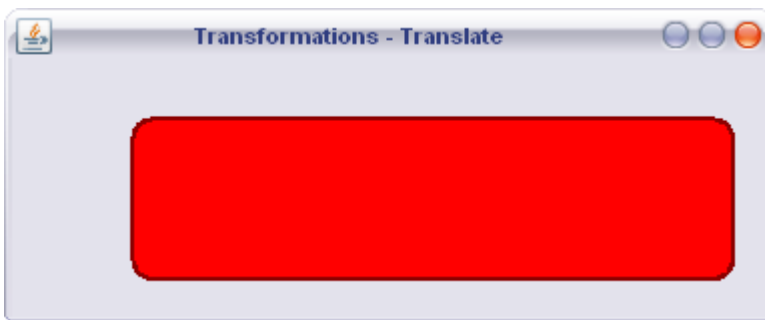

Scale

```
rect( x: 10, y: 10, width: 300, height: 80, arcWidth: 20, arcHeight: 20,  
borderColor: 'darkRed', borderWidth: 2, fill: 'red' ){  
transformations {  
scale( x: 1.5, y: 0.5 )  
}  
}
```



Skew

```
rect( x: 10, y: 10, width: 300, height: 80, arcWidth: 20, arcHeight: 20,
borderColor: 'darkRed', borderWidth: 2, fill: 'red' ){
transformations {
skew( x: 0.5, y:0 )
}
}
```

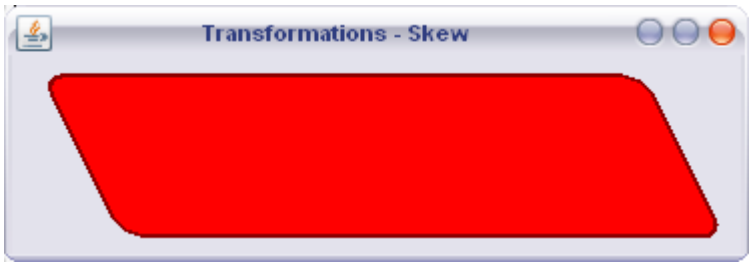

Rotate

```
rect( x: 10, y: 10, width: 300, height: 80, arcWidth: 20, arcHeight: 20,
borderColor: 'darkRed', borderWidth: 2, fill: 'red' ){
transformations {
rotate( angle: 45, x: 50, y: 50 )
}
}
```

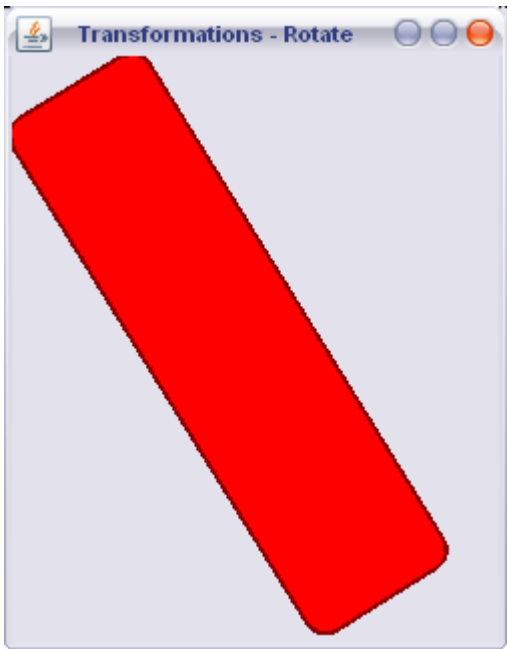

Grapplet

This page last changed on Aug 07, 2007 by [paulk_asert](#).

Contribution Overview

Grapplet provides a way for running Groovy on an applet, adding extra functionality to JS objects and arrays, for example arrays behave like Java Lists, so all GDK methods available to List and Collection can be used in JS arrays.

Grapplet will automatically look for all <script> tags available in the page that have its language property set to "text/x-groovy". This was inspired by a post on Dion's blog: [Running Ruby in the browser via script type="text/ruby"](#).

Once Grapplet is running on a page, you can evaluate any Groovy script by calling evaluateScript().

Team Members

Andres Almiray [aalmiray at users dot sourceforge dot net]

Download

Distributions

Pending.

Installing

Pending.

Pre-requisites

None

Documentation

In order to run Grapplet it needs to be signed, follow the next instructions to use a self-signed certificate (recommended for testing)

In order to run Groovy on a browser you'll need to sign the applet. Follow the steps to sign an applet with your own certificate.

1. Create a keystore which will hold the certificate.
I created an external keystore so I wouldn't mess up my personal security settings while finding out the correct way to do it. All you have to do is issue the following command:

```
keytool -genkey -keystore groovy -storepass groovy -keypass groovy \  
-alias groovy
```

2. Trust your own certificate.
Unless you want to spend some bucks on this experiment I recommend you selfcert your certificate. To selfcert your newly created certificate, issue the following command:

```
keytool -selfcert -keystore groovy -storepass groovy -keypass groovy \  
-alias groovy
```

3. Export your certificate. Export your certificate to an external file with the following command:

```
keytool -export -keystore groovy -storepass groovy -keypass groovy \  
-alias groovy -file groovy.cer
```

4. Sign the jar. This will attach the certificate to the jar and add entries to the jar's manifest.

```
jarsigner -keystore groovy -storepass groovy -keypass groovy \  
grapplet-0.1.jar groovy
```

5. Verify your jar (just in case). You may verify that your jar has indeed been signed and includes the certificate, for more information on jarsigner's output refer to the command's help (jarsigner -help):

```
jarsigner -verify -verbose -certs -keystore groovy grapplet-0.1.jar
```

6. Configure your local security settings. For this step you must touch \$JRE_HOME/lib/security/java.policy and \$JRE_HOME/lib/security/java.security, in windows \$JRE_HOME usually points to "c:/Program Files/Java/jdk1.x.x/".

1. Add the following lines at the end of java.policy:

```
grant {  
  java.lang.RuntimePermission "usePolicy";  
};
```

2. Create a file named '.java.policy' at \$USER_HOME with the following contents:

```
keystore "file:${user.home}/groovy";  
grant signedBy "groovy" {  
  permission java.security.AllPermission;  
};  
grant codeBase "http://localhost" {  
  permission java.security.AllPermission;  
};
```

3. Copy the keystore 'groovy' and 'groovy.cer' (just in case) to \$USER_HOME.

7. Copy the binary dist to your webserver. If you're using Apache copy grapplet.html, groovy.js, grapplet-0.1.jar, groovy-all-1.0.jar, groovy and groovy.cer to \$APACHE_HOME/htdocs/grapplet

Developers

Source Control

<http://svn.codehaus.org/groovy-contrib/grapplet>

Building

Grapplet uses Maven2 as its build tool, which means that if you want to build your own version of Grapplet from source you'll need to have it installed. Follow the instructions at <http://maven.apache.org> Once Maven2 is installed you will also need to install the java-plugin into your maven repository (but it wouldn't hurt to check at <http://mvnrepository.org> if it is already there). Usually the plugin is located at \$JDK_HOME/jre/lib/plugin.jar

You can install it on your local Maven2 repo with the following command

```
mvn install:installFile -DgroupId=com.sun.java-plugin -Dversion=<jdkversion> \  
-Dpackaging=jar -DartifactId=java-plugin \  
-Dfile= $JDK_HOME/jre/lib/plugin.jar
```

where <jdkversion> is the version number of the selected jdk. Grapplet has version 1.6.0 configured, if you change version you'll have to update pom.xml

After you have the required dependencies installed, you may generate the package

by typing

```
mvn package
```

Now you'll have to sign `grapplet-<version>.jar`, copy it and `groovy.js` to your `webapp` or `webserver` dir. The file `src/html/grapplet.html` should give you some pointers in how it should be configured.

The next section will describe the process of self-signing the jar.

Contributing

Please contact the team members by e-mail.

Community

Mailing List(s)

<http://groovy.codehaus.org/Mailing+Lists>

Issue tracker

<http://jira.codehaus.org/secure/BrowseProject.jspx?id=10242>

Why Griffon?

- Liger was taken, [apparently](#).
- Griffons have large talons.
- Excellent skills in [jump and spot](#) as well.

What's in Griffon?

New Feature Development

- **UberBuilder** - a compositing FactoryBuilderSupport class, which allows seamless merging of existing Builders
- **GUIBuilder** - An UberBuilder with SwingBuilder, SwingXBuilder, and GraphicsBuilder pre-loaded.

Groovy Core R&D for Desktop stuff

Quicker cycling and more risky experimental changes to some core Groovy classes will be done here as well

- **FactoryBuilderSupport** - needed changes for UberBuilder to work
- **SwingBuilder** - needed changes for UberBuilder to work

Future Directions

There are lots of things Griffon could move into, for example

- A home for the multiple GUI builders for Groovy, It may be worthwhile to merge SwingXBuilder, JIIDEBuilder, and GraphicsBuilder under a single code base (still with separate releases).
- A desktop port of GORM could be hosted here
- A desktop variant of the Grails/Rails project structure could be supported, with deployment to Applets, WebStart, or vanilla client Jar files.

Heirarchy

- Object
 - GroovyObjectSupport
 - Binding
 - FactoryBuilderSupport
 - griffon.builder.UberBuilder
 - griffon.gui.GUIBuilder

The logic to support all of the non-specific builder magic will go into UberBuilder. GUIBuilder will be an instance of UberBuilder with specific factories pre-loaded into the cache.

Constructor

The only constructor will be

```
UberBuilder(Object[] builders) {
builders.each {if (it) uberInit(it)}
}
```

This is driven by the use case. Each uberInit method will exploit the dynamic dispatch mechanism of Groovy to match to the proper uberInit method.

Consider the following calls

```
UberBuilder('ant', 'swing', 'DOM')
UberBuilder(AntBuilder, SwingBuilder, DOMBuilder)
UberBuilder(new AntBuilder(), new SwingBuilder(), new DOMBuilder())
```

All three of these would create an UberBuilder with ant, swing, and dom factories pre-loaded. Other factories may be addable if the child instance exposes the factory registration methods publicly. (some UberBuilders may not want to).

First, there will be an internal registry mapping, mapping some object (usually strings) to the relevant registrations for the UberBuilder. Hence the fallback case:

```
public final uberInit(Object builderKey) {
def builder = buildersRegistry[builderKey]
// make sure we won't self-loop
if (builder?.metaClass?.respondsTo(builder, 'uberInit', builder.class)?.size() > 1) {
// if we get more than one, we have more than this base case, so look it up
return uberInit(builder)
}
}
```

We basically try to init again if we don't get a match, except we look at the internal registry cache to 'de-reference' the symbol. Usually a String, but there may be instances where we may want to intercept a class. (should we move the dereferencing to the constructor?)

String

This is always a de-reference. May not even need an uberInit method, except for clarity

Class

If the class is assignable to FactoryBuilderSupport, we attempt to no-args construct it. If we are successful we feed it to uberInit(FactoryBuilderSupport), if not we feed it to uberInit(Object) before failing.

FactoryBuilderSupport

There are two approaches we can use here, not sure which is best.

1. We can wrap the builder's nodes using `withBuilder` and re-direct them into the proxy
2. We can take all of the registered factories and stuff them into this `UberBuilder`.

Map

Maps will be handled based on the type of the value argument. We may even want to allow 'unwrapped' calls via type tricks, ie

```
uberBuilder(J: SwingBuilder, SwingXBuilder, Ant:AntBuilder, '<':DOMBuilder)
```

Factory value

The key will be registered as a node name and the factory will be the value

FactoryBuilderSupport

The key will be a prefix to each of the nodes and it will be otherwise treated as a call with just the `FactoryBuilderSupport`.

Groosh

This page last changed on Mar 26, 2008 by [eggeral](#).

Provides a shell-like capability for handling external processes.

Module Overview

Groosh is a Unix like shell written in Groovy. It has also been known as the Process Module but was renamed (back) when it was updated to work with Groovy 1.0.

The current version of Groosh is 0.3.0

Team Members

- Yuri Schimke - Founder and original contributor
- Alexander Egger [alexander.egger at campus02.at] - Current maintainer

Download

Distributions

Source and binary releases are available at <http://svn.codehaus.org/groovy-contrib/groosh/releases>.

A RPM package for openSUSE 10.2 can be installed via the openSUSE Build Service repository http://download.opensuse.org/repositories/home:eggeral/openSUSE_10.2.

A RPM package for openSUSE 10.3 can be installed via the openSUSE Build Service repository http://download.opensuse.org/repositories/home:eggeral/openSUSE_10.3.

Installing

If you use the openSUSE RPM, just install it and you are ready to go.

If you use the binary distribution e.g. (groosh-0.3.0-bin.tar.gz).
Untar it and copy groosh-0.3.0.jar to your \$GROOVY_HOME/lib.

Try the following script to check if it worked:

```
def gsh = new groosh.Groosh;  
gsh.ls().toStdOut();
```

Have a look at the *examples* directory for more examples how to use groosh.

Pre-requisites

Groosh is based on Groovy 1.5.0 or higher.

Documentation

The following example shows Groosh in action:

```
def gsh = new groosh.Groosh();  
gsh.cat('test_scripts/blah.txt').toStdOut();
```

Another example :

```
def gsh = new groosh.Groosh();  
def f = gsh.find('.', '-name', '*.java', '-ls');
```

```

def total = 0;
def lines = gsh.grid { values,w |
def x = values[2,4,6,10];
def s = x.join(' ');
w.println(s);
def total += Integer.parseInt(values[6]);
};

f.pipeTo(lines);
lines.toStdOut();

println "Total: " + tota);

```

Sometimes the name of a shell command conflicts with a Groovy method (for example "grep"). This means that

```
gsh.grep(...)
```

does not execute the shell command, but the Groovy method `grep(...)`.

As a workaround for that you may prefix any shell command with `_` this means the example above becomes

```
gsh._grep(...)
```

The following example shows a more elaborate example. It uploads photos to a flickr account using the command line tool flickcurl. A photo set of this images is created and named after the current directory.

```

import static groosh.Groosh.groosh
import static org.codehaus.groovy.groosh.stream.DevNull.devnull

ids = [:]
shell = groosh()

//get all images in this folder and upload it to flickr
//remember the photo id we get from flickr
shell.ls().grep(~/*.jpg/).each {
    println "Uploading file $it to flickr"
    flickcurl = shell.flickcurl("upload",it,"friend","family").useError(true)
    id = flickcurl.grep(~/*Photo ID.*/)[0].split(":")[1].trim()
    ids[it] = id
    println "Photo ID is: $id"
}
//we need to know the first photo id
firstKey = ids.keySet().toList()[0]

//create a set with the name of the directory we are in right now
//use the id of the first photo as set cover
setName = shell.pwd().text.split("/)[-1]
println "Creating set: $setName"
flickcurl = shell.flickcurl("photosets.create",setName,setName,ids[firstKey]).useError(true)
id = flickcurl.grep(~/*Photoset.*/)[0].split(" ")[2].trim()
println "Photoset ID is: $id"

//make a backup of the ids in a file for later reference
println "Writing ids to a file"
file = new File(shell.pwd().text.trim() + "/.flickrset")
file << "Photoset:" << id << "\n"
ids.each {
    file << it.key << ":" << it.value << "\n"
}

//the first photo is allready part of the photo set so lets remove it
ids.remove(firstKey)

//add the remaining photos to the photo set
ids.each {

```



```
println "Adding photo to set at flickr: $it"
shell.flickrurl("photosets.addPhoto",id,it.value) | devnull()
}

println "DONE"
```

Developers

Source Control

The Groosh source code is available from the Codehaus SVN at <http://svn.codehaus.org/groovy-contrib/groosh/trunk>.

Building

Building from the source distribution

Untar/unzip the source distribution file (e.g. groosh-0.3.0-src.tar.gz)

Groosh uses Maven 2 for building. You have to have Maven 2 installed. Just execute mvn in the groosh directory and groosh-0.3.0.jar gets build as well as the source and binary distribution.

Building the SVN version

Check out the source from <http://svn.codehaus.org/groovy-contrib/groosh/trunk/>

Building works the same as for the source distribution.

Contributing

Please contact Alexander Egger [alexander.egger at campus02.at] by e-mail.

Community

Mailing List(s)

<http://groovy.codehaus.org/Mailing+Lists>

Issue tracker

<http://jira.codehaus.org/secure/BrowseProject.jspx?id=10242>

Groovy Jabber-RPC

[Jabber-RPC](#)

allows you to make XML-RPC calls using the Jabber protocol. Groovy has a Jabber-RPC implementation which allows you to create a local Jabber-RPC server and to make calls on remote Jabber-RPC servers. Jabber servers are widely available and very easy to set up and run. The Google GTalk service uses Jabber and the Groovy Jabber-RPC package works over GTalk. We use the excellent

[Smack](#)

Jabber library from Jive Software to handle the protocol details.

The Server

It's really easy to set up a server which provides a set of remotely callable functions.

1. Create a server object

```
import groovy.net.xmlrpc.*
import org.jivesoftware.smack.XMPPConnection
```

```
def server = new JabberRPCServer()
```

2. Add some methods

```
server.echo = {return it} // the closure is now named "echo" and is remotely callable
```

3. Start the server

```
def serverConnection = new XMPPConnection("talk.example.org", 5222, "example.org")
serverConnection.login("myServerId", "myServerPassword") // logging in as
myServerId@example.org
server.startServer(serverConnection)
```

4. You're done!

The Client

It's pretty easy to make the remote calls too

1. Create a proxy object to represent the remote server

```
def clientConnection = new XMPPConnection("talk.example.org", 5222, "example.org")
clientConnection.login("myClientId", "myClientPassword") // logging in as
myClientId@example.orgm
def serverProxy = new JabberRPCServerProxy(clientConnection, "myServerId")
```

2. Call the remote method via the proxy

```
println serverProxy.echo("Hello World!")
```

3. As long as myClientId@example.org and myServerId@example.org are buddies then the call will be made and the result returned

Groovy Monkey



This page last changed on Sep 25, 2006 by [paulk_asert](#).

Groovy Monkey is a dynamic scripting tool for the Eclipse Platform that enables you to automate tasks, explore the Eclipse API and engage in rapid prototyping. In fact, I think that if you are working on automating tasks in Eclipse or doing Plugin development in general, this tool is one for you. Groovy Monkey can allow you to try out code and do rapid prototyping without the overhead of deploying a plugin or creating a separate runtime instance.



Groovy Monkey is based on the Eclipse Jobs API, which enables you to monitor the progress in the platform seamlessly and allows you to write your scripts so that users can cancel them midway. Groovy Monkey is also based on the Bean Scripting Framework ([BSF](#)) so that you can write your Groovy Monkey scripts in a number of languages (particularly Groovy). In fact you can write in Groovy, Beanshell, Ruby or Python. The project update site is located at the Groovy-Monkey SourceForge site (update sites: [Eclipse v3.2](#) or [Eclipse v3.1.2](#)). Direct download of Groovy Monkey directly goto http://sourceforge.net/project/showfiles.php?group_id=168501

Requirements

Eclipse Version compatibility

-  Eclipse 3.1 : working [update site](#)
-  Eclipse 3.2 : working [update site](#)

Java Version compatibility

-  1.4
-  5.0
-  6.0

Addition one: metadata keywords

LANG metadata keyword

First, there is a new metadata keyword called LANG, which as is implied, determines what scripting language you wish to use. Here is an example of an Groovy Monkey base example ported to Groovy:

FindSystemPrints_groovy.gm

```
/*
 * Menu: Find System Prints > Groovy
 * Kudos: Bjorn Freeman-Benson & Ward Cunningham & James E. Ervin
 * LANG: Groovy
 * Job: UIJob
 * License: EPL 1.0
 */

def files = resources.filesMatching(".*\\.java")
for( file in files )
{
file.removeMyTasks( metadata.path() )
for( line in file.lines )
{
if( line.string.trim().contains( 'System.out.print' ) )
{
line.addMyTask( metadata.path(), line.string.trim() )
}
}
}
window.getActivePage().showView( 'org.eclipse.ui.views.TaskList' )
```

Notice the LANG tag, that is all there is to that. There is also a New Groovy Monkey Script wizard available that has the legal values in pulldown menus.

Job metadata keyword

The Job metadata tag allows you to specify what kind of Eclipse Job that your Groovy Monkey script will be run in. By default it is set to Job, but UIJob and WorkspaceJob are also available. In Eclipse it is best to run almost all of your code from outside the UI Thread so UIJob is not recommended. To enable you to access UI elements from within your script there is a Runner DOM that enables your script to pass a Runnable object that can be called from the `asyncExec()` or `syncExec()` methods. For Groovy the JFace DOM allows you to pass a Closure directly to be invoked from either `asyncExec()` or `syncExec()`.

Exec-Mode metadata keyword

The Exec-Mode metadata keyword allows you to specify whether the script should be run in the background (default) or foreground. The foreground mode has Eclipse directly pop up a modal dialog box that shows the user the progress of the script, the background mode does not.

Include metadata keyword

The Include metadata keyword allows you to specify a resource in your workspace and to directly add it to the classloader of your Groovy Monkey script. Examples would obviously include jar files or directories.

Include-Bundle metadata keyword

The Include-Bundle metadata keyword allows you to have an installed bundle be directly added to the classloader of your Groovy Monkey script.

Addition two: Outline view

Secondly, the outline view is populated showing the binding variable names and types with their publicly available methods and fields. This can be useful since the DOMs are loaded on your eclipse ide as plugins and not in your workspace view. Even if you were to load in the DOMs into your workspace, there is still a great deal of switching that must be done.

You can double click on a type in the outline view and have it open the source directly in your editor, if you have included external plugins in your Java search path.

There is also an "Installed DOMs" view that shows the installed DOM plugins currently in your Eclipse workbench. The editor also includes a right click command to display a dialog that lists the and will install available DOMs to your script.

Addition three: Groovy SWT and Launch Manager DOMs

Thirdly, there are new DOMs that are located on the update site that include direct access to a console for output, enable you to script your launch configurations together and a wrapper for the Groovy SWT project as a DOM.

Here is an example of a script, copied from the examples given in Groovy-SWT, ported into Groovy Monkey. The Groovy-SWT DOM is now included by default when you have the `net.sf.groovyMonkey.groovy` fragment installed. The `net.sf.groovyMonkey.groovy` fragment contains Groovy Monkey's support for the Groovy language.

SWTTest.gm

```
/*
 * Menu: Test SWT
 * Kudos: James E. Ervin
 * License: EPL 1.0
 * Job: UIJob
 */

def subapp = jface.shell( window.getShell() )
```

```

{
gridLayout()
group( text:'Groovy SWT', background:[255, 255, 255] )
{
gridLayout()
label( text:"groove fun !" ,background:[255, 255, 255] )
label( text:"Email: ckl@dacelo.nl", background:[255, 255, 255] )
}
}
subapp.pack()
subapp.open()

```

Here is an example of a script that uses the Launch Configuration Manager DOM along with the JFace/ SWT DOM and the Console output DOM. It prints out the list of all your available launch configurations and allows you to select which ones you wish to string together.

LaunchManager.gm

```

/*
* Menu: Launch Manager
* Kudos: James E. Ervin
* License: EPL 1.0
* LANG: Groovy
* Job: UIJob
* DOM: http://groovy-monkey.sourceforge.net/update/net.sf.groovyMonkey.dom
*/
import org.eclipse.swt.SWT

def configurations = launchManager.manager().getLaunchConfigurations()
def selected = []
shell = jface.shell( text: 'Select desired configurations:', location: [ 100, 100 ] )
{
gridLayout()
table = table( toolTipText: "Select configurations to execute",
style:'check,border,v_scroll,h_scroll,single' )
{
gridLayout()
gridData( horizontalAlignment: SWT.FILL, verticalAlignment: SWT.FILL, grabExcessHorizontalSpace:
true,
grabExcessVerticalSpace: true, heightHint: 400 )
for( config in configurations )
{
tableItem().setText( "${config.name}" )
}
}
composite()
{
gridLayout( numColumns: 2 )
button( text: 'run', background: [ 0, 255, 255 ] )
{
onEvent( type: 'Selection', closure:
{
for( item in table.items )
{
if( !item.checked )
continue
selected.add( item.text )
}
shell.close()
} )
}
button( text: "cancel", background: [ 0, 255, 255 ] )
{
onEvent( type: 'Selection', closure:
{
selected.clear()
}
}
}
}

```

```
shell.close()
} )
}
}
}
shell.pack()
shell.open()
while( !shell.isDisposed() )
{
if( !shell.display.readAndDispatch() )
shell.display.sleep()
}
selected.each
{
out.println "${it}"
}

launchManager.launch( 'launch test', selected )
```

Groovy SOAP

This page last changed on Mar 03, 2008 by [galleon](#).



Deprecated Module

Before using GroovySOAP, make sure to check [GroovyWS](#)

Introduction

[SOAP](#) is a lightweight protocol intended for exchanging structured information in a decentralized, distributed environment. Groovy has a SOAP implementation based on [Xfire](#) which allows you to create a SOAP server and/or make calls to remote SOAP servers using Groovy.

Installation

You just need to download [this](#) jar file in your `${user.home}/.groovy/lib` directory. This jar file embeds all the dependencies.

Getting Started

The Server

You can develop your web service using a groovy script and/or a groovy class. The following two groovy files are valid for building a web-service.

1. MathService.groovy

```
public class MathService {
    double add(double arg0, double arg1) {
        return (arg0 + arg1)
    }
    double square(double arg0) {
        return (arg0 * arg0)
    }
}
```

2. You can also using something more Groovy

```
double add(double arg0, double arg1) {
    return (arg0 + arg1)
}
double square(double arg0) {
    return (arg0 * arg0)
}
```

3. Then the easy part ... no need for comments

```
import groovy.net.soap.SoapServer

def server = new SoapServer("localhost", 6980)

server.setNode("MathService")

server.start()
```

That's all !

The Client

1. Oh ... you want to test it ... two more lines.

```
import groovy.net.soap.SoapClient

def proxy = new SoapClient("http://localhost:6980/MathServiceInterface?wsdl")

def result = proxy.add(1.0, 2.0)
assert (result == 3.0)

result = proxy.square(3.0)
assert (result == 9.0)
```

2. You're done!

Custom Data Types

This example shows how to use custom data types with Groovy SOAP. The code can be downloaded from [here](#).

The Server

The `PersonService.groovy` script contains the service implementation and the custom data type (`Person`).

PersonService.groovy

```
class Person {
    int id
    String firstname
    String lastname
}

Person findPerson(int id) {
    return new Person(id:id, firstname:'First', lastname:'Last')
```

`Server.groovy` is equivalent to the previous example.

Server.groovy

```
import groovy.net.soap.SoapServer;

def server = new SoapServer("localhost", 6980);
server.setNode("PersonService");
server.start();
```

For each class compiled by the groovy compiler a `metaClass` property is added to the bytecode. This property must be excluded from being mapped by XFire, otherwise an error will be reported when trying to obtain the WSDL document from <http://localhost:6980/PersonServiceInterface?wsdl>. The reason is that XFire cannot map `groovy.lang.MetaClass`. To ignore the `metaClass` property a custom type mapping must be defined (for details refer to [Aegis Binding](#)).

Person.aegis.xml

```
<?xml version="1.0" encoding="UTF-8"?>
<mappings xmlns:sample="http://DefaultNamespace">
  <mapping name="sample:Person">
    <property name="metaClass" ignore="true"/>
  </mapping>
</mappings>
```

However, if you compile custom data types from Java the bytecode won't contain a `metaClass` property and, hence, there is no need to define a custom mapping.

The Client

Client.groovy

```
import groovy.net.soap.SoapClient

def proxy = new SoapClient('http://localhost:6980/PersonServiceInterface?wsdl')
def person = proxy.findPerson(12)
println 'Person (' + person.id + ') = ' +
person.firstname + ' ' + person.lastname
```

More Information

Current limitations (and workaround)

1. No authentication (see JIRA issue 1457)
2. No proxy support (see JIRA issue 1458)
3. Numeric values are represented as strings in custom data types and arrays.
4. Custom data types cannot be processed on client side when using the Groovy SOAP module with the current groovy-1.0 release.
5. It looks like the XFire dynamic client does not support complex datatypes. This may be a concern if you need for example to transfer an Image as a byte array. The workaround I use is to transform this in a String and transfer that String - As this is a bit painful I am investigating moving to the regular XFire client. Here is a little program demo-ing this (look at this "disco age" image - Is Groovy that old ?

The client (ImageClient.groovy)

```
import groovy.swing.SwingBuilder
import groovy.net.soap.SoapClient
import javax.swing.ImageIcon
import org.apache.commons.codec.binary.Base64

proxy = new SoapClient("http://localhost:6980/ImageServiceInterface?WSDL")

// get the string, transform it to a byte array and decode this array
b64 = new Base64()
bbytes = b64.decode(proxy.getImage().getBytes())

swing = new groovy.swing.SwingBuilder()

// this is regular SwingBuilder stuff
il = swing.label(icon:new ImageIcon(bbytes))
frame = swing.frame(title:'Groovy logo',
defaultCloseOperation:javax.swing.WindowConstants.DISPOSE_ON_CLOSE) {
panel(){
widget(il)
}
}
frame.pack()
frame.show()
```

The (ugly) server part embedding the image which is Base64 encoded (ImageServer.groovy):

```
import groovy.net.soap.SoapServer

def server = new SoapServer("localhost", 6980)
server.setNode("ImageService")
server.start()
```

and the missing and secret part is [here](#).

Demos with public web services

There exist a lot of web-services available for testing. One which is pretty easy to evaluate is the currency rate calculator from webservicex.net.

Here is a small swing sample that demonstrate the use of the service. Enjoy !

```
import groovy.swing.SwingBuilder
import groovy.net.soap.SoapClient

proxy = new SoapClient("http://www.webservicex.net/CurrencyConvertor.asmx?WSDL")

def currency = ['USD', 'EUR', 'CAD', 'GBP', 'AUD']
def rate = 0.0

swing = new SwingBuilder()

refresh = swing.action(
name: 'Refresh',
closure: this.&refreshText,
mnemonic: 'R'
)

frame = swing.frame(title: 'Currency Demo') {
panel {
label 'Currency rate from '
comboBox(id: 'from', items: currency)
label ' to '
comboBox(id: 'to', items: currency)
label ' is '
textField(id: 'currency', columns: 10, rate.toString())
button(text: 'Go !', action: refresh)
}
}
frame.pack()
frame.show()

def refreshText(event) {
rate = proxy.ConversionRate(swing.from.getSelectedItem(), swing.to.getSelectedItem())
swing.currency.text = rate
}
```

And here is the result:



GroovyLab

This page last changed on Oct 10, 2007 by [yannrichet](#).

Provides a domain specific language (DSL) for math engineering (matlab-like syntax).

Module Overview

GroovyLab is a set of Groovy classes and Java libraries. It provides common linear algebra and plot static methods easily usable in any groovy script or class.

GroovyLab is fully usable, but still in development status. It is based on [JMathTools](#) Java API (based on JAMA and RngPack).

Team Members

- Yann Richet - Contributor to JMathTools Java project

GroovyLab is just provided to start a math engineering DSL sub-project of Groovy. If you need GroovyLab, GroovyLab also needs you...

Download

Distributions

Source release available at [JMathTools website](#)

Installing

Just extract the GroovyLab archive, and try to run examples cases using groovylab.bat or groovylab script: '

- groovylab examples/simpleTest.gvl
- groovylab examples/moreTest.gvl

Pre-requisites

GroovyLab is based on Groovy 1.1 and Java 1.5.

Documentation

The following example shows GroovyLab in action:

```
import static org.math.array.Matrix.*
import static org.math.plot.Plot.*

def A = rand(10,3)
println A
plot("A",A,"SCATTER")

import static org.math.array.Matrix.*
import static org.math.plot.Plot.*

def A = rand(10,3)           // random Matrix of 10 rows and 3 columns
def B = fill(10,3,1.0)     // one Matrix of 10 rows and 3 columns
def C = A + B              // support for matrix addition with "+" or "-"
def D = A - 2.0            // support for number addition with "+" or "-"
def E = A * B              // support for matrix multiplication or division
def F = rand(3,3)
def G = F**(-1)           // support for matrix power (with integers only)
```

```
println A // display Matrix content

plot("A",A,"SCATTER") // plot Matrix values as ScatterPlot

def M = rand(5,5) + id(5) //Eigenvalues decomposition
println "M=\n" + M
println "V=\n" + V(M)
println "D=\n" + D(M)
println "M~\n" + (V(M) * D(M) * V(M)**(-1))
```

GroovyRestlet

This page last changed on Mar 04, 2008 by [keke](#).

Module Overview

GroovyRestlet is a simple DSL for constructing [Restlet](#) application in a simple, shortcutting syntax.

Download

Distributions

GroovyRestlet is distributed as a single jar.

Current release

Current release of GroovyRestlet is 0.2-SNAPSHOT, download from [here](#)

Features

- Upgrade to Restlet 1.1 M2

Old releases

- GroovyRestlet 0.1 download from [here](#) for Restlet 1.1-SNAPSHOT

Pre-requisites

At current moment, GroovyRestlet depends following:

- Groovy 1.5
- Java 1.5
- Restlet 1.1-SNAPSHOT
- SLF4J 1.4.3 as logging tool
- Spring 2.5 if spring integration is required
- commons-lang 2.3

Installing

Drop GroovyRestlet and all dependencies in your Java classpath.

Documentation

Quick start

First, create an instance of GroovyRestlet first.

```
GroovyRestlet gr = new GroovyRestlet()
```

 If you want Spring support, provide an instance of `ApplicationContext` as the constructor parameter.

```
GroovyRestlet gr = new GroovyRestlet(appCtx);
```

Then, prepare your Restlet building script using simple GroovyRestlet DSL syntax. Calling `GroovyRestlet.build(URI)` then done.

Check [GroovyRestlet User Guide](#) for detail user information.

Examples

Here is one GroovyRestlet DSL example, inspired from [Restlet tutorial 11](#).

```
builder.component{
current.servers.add(protocol.HTTP, 8182)
application(uri:""){
router{
def guard = guard(uri:"/docs", scheme:challengeScheme.HTTP_BASIC,
realm:"Restlet Tutorials")
guard.secrets.put("scott", "tiger".toCharArray())
guard.next = directory(root:"", autoAttach:false)
restlet(uri:"/users/{user}", handle:{req,resp->
resp.setEntity("Account of user \"${req.attributes.get('user')}\",
mediaType.TEXT_PLAIN)
})
restlet(uri:"/users/{user}/orders", handle:{req, resp->
resp.setEntity("Orders or user \"${req.attributes.get('user')}\",
mediaType.TEXT_PLAIN)
})
restlet(uri:"/users/{user}/orders/{order}", handle:{req, resp->
def attrs = req.attributes
def message = "Order \"${attrs.get('order')}\" for User \"${attrs.get('user')}\""
resp.setEntity(message, mediaType.TEXT_PLAIN)
})
}
}
}.start()
```

For more examples:

- [Complete examples](#) for [Restlet tutorial](#)
- [SpringIntegrationExamples](#)

Developers

Source Control

<http://svn.codehaus.org/groovy-contrib/groovyrestlet/trunk>

Building

GroovyRestlet uses Maven 2 as its building tool.

Contributing

Feel free to contribute.

Mailing List(s)

<http://groovy.codehaus.org/Mailing+Lists>

Issue tracker

<http://jira.codehaus.org/browse/GROOVY>

GroovyRestlet User Guide

This page last changed on Feb 29, 2008 by [keke](#).

Introduction

Very simple usage

An instance of `GroovyRestlet` is the starting point of everything.

You can programmatically create an instance of `GroovyRestlet`:

```
GroovyRestlet gr = new GroovyRestlet();//#1
```

```
GroovyRestlet grWithSpring = new GroovyRestlet(springApplicationContext); // #2
```

Constructor method of #2 indicates that this instance of `GroovyRestlet` will consult Spring's `ApplicationContext` when constructing its component. So the Spring integration is done.

Alternatively, you can choose to declare `GroovyRestlet` in Spring bean definition. By this way, `GroovyRestlet` will automatically use its parent context when constructing its components.

```
<bean id="groovyRestlet" class="org.lpny.groovyrestlet.GroovyRestlet"/>
```

Spring Integration

When Spring's `ApplicationContext` is provided, `GroovyRestlet` will try to consult Spring context for creating its components.

Two special attributes are provided for integrating `GroovyRestlet` and Spring.

- **ofBean**: to tell `GroovyRestlet` that to create a component from Spring context by a bean name;
- **ofClass**: to tell `GroovyRestlet` that to create a component using Spring's [AutowireCapableBeanFactory](#)



`GroovyRestlet` will only use `AutowireCapableBeanFactory` to create instance indicated by **ofClass** when Spring context is provided. Otherwise it will create an instance of that class using Java reflection

Technical detail

GroovyRestlet

As the only entry point of `GroovyRestlet`, this instance automatically declares a number of global variables in the Groovy context. Users are also be able to provide their special context variables. In order to do that, users can provide a map of customer context when calling `build` method.

```
groovyRestlet.build(userDefinedContext, scriptURI);
```



Be careful

This **userDefinedContext** is only visible for each call of `build` method. It will be merged into Groovy context and removed after each calling. And variables of **userDefinedContext** can override values of default context. Be careful when doing this.

RestletBuilder

`RestletBuilder` is a simple implementation of Groovy's `FactoryBuilderSupport`. By default, all constructor factories are registered. Users are able choose which constructors are to be used freely.

To do this programmatically, just set a list of constructor factories after a build instance is created.

```
RestletBuilder builder = new RestletBuilder()

builder.setFactories(yourFactoryList);

groovyRestlet.setBuilder(builder)
```

Alternatively, you can do this in Spring bean definition

```
<bean id="groovyRestlet" class="org.lpny.groovyrestlet.GroovyRestlet">
<property name="builder" ref="restletBuilder"/>
</bean>

<bean id="restletBuilder" class="org.lpny.groovyrestlet.builder.RestletBuilder">
<property name="factories">
<list>
<!-- any factory instance -->
</list>
</property>
</bean>
```

Global variables

For convenience, `GroovyRestlet` add a number of Restlet-related variables to Groovy global context. Users can directly refer them in there building scripts.

Name	Usage	Example
builder	The reference of a builder	<code>builder.component()</code>
protocol	Shortcut to Restlet Protocol	<code>protocol.HTTP</code>
mediaType	Shortcut to Restlet MediaType	<code>mediaType.TEXT_PLAIN</code>
status	Shortcut to Restlet Status	<code>status.CLIENT_ERROR_NOT_FOUND</code>
challengeScheme	Shortcut to Restlet ChallengeScheme	<code>challengeScheme.HTTP_BASIC</code>
redirectorMode	Shortcut to mode of Restlet Redirector	<code>redirectorMode.MODE_CLIENT_FOUND</code>
routingMode	Shortcut to mode of Restlet Router	<code>routingMode.BEST</code>
transformer	Shortcut to mode of Restlet Transformer	<code>transformer.MODE_REQUEST</code>
global	Special shortcut providing a set of global variables and methods	

At current moment, you can call `global.status(404)` to create a `CLIENT_ERROR_NOT_FOUND` status.

Constructors

Every constructor is support **ofBean** and **ofClass** attributes. The value of **ofBean** must be a Sting. **ofBean** is only effected when a Spring context is provided. The value of **ofClass** can either be a String or an instance of Java Class.

According to [Groovy Builders](#), constructors can be nested to each other. In that case, `GroovyRestlet` will automatically set up Restlet-specific relationship between parent and child instances. But user can disable this feature by setting **autoAttach** attribute as `false`.

In Restlet, the Router.attach method returns a Route instance. In order to do some special process on the Route instance, an attribute **postAttach** which refers to a Groovy closure is provided. For example:

```
builder.router{
restlet(uri:"/users/{user}", postAttach:{route->
//do some post attaching process here
//...
})
}
```

Another important attribute is **uri** which indicates a [URI Template](#) using by Restlet Router.

restlet

The generic constructor for all components of type of [Restlet](#). You can use **ofClass** attribute to indicate restlet to create an instance of a subtype. When doing that, using attribute **consArgs** to provide arguments array of corresponding constructor. For example:

```
builder.restlet(ofClass:"org.restlet.Transform", consArgs:[transformer.MODE_REQUEST, sheet] as
Object[])
```

Another important attribute of restlet is **handle**, which refers to a Groovy closure. Once this attribute provided, this closure will override the default [handle](#) method of the Restlet.

```
builder.restlet(handle:{request, response, self->
return new StringRepresentation("Hello GroovyRestlet")
})
```

Sometimes it is necessary to access the instance of Restlet itself. You can do that by appending an additional argument in the closure argument list. GroovyRestlet will automatically pass the calling instance to the closure as shown in above example.

 This **handle** attribute is only effected when neither **ofClass** nor **ofBean** attribute is used.

server

A shortcut to create a Restlet Server. Instance of the nested constructor of a server will become the [server's target](#). If more nested constructors are defined, only the last one will be selected.

Attributes:

- **protocol:** the server protocol
- **protocols:** a list of server protocols
- **address:** the address of server
- **port:** the port of server

client

A shortcut to create a Restlet Client.

Attributes:

- **protocol:** the client protocol
- **protocols:** a list of client protocols

component

A shortcut to create a Restlet Component. If no VirtualHost is specified, direct children of component constructor will be attached to Component's [default VirtualHost](#). For example,

```
builder.component{
application(uri:"")
}
```

Which is equivalent to Java code:

```
Component component = new Component();
component.getDefaultHost().attach("", new Application());
```

application

A shortcut to create a Restlet Application. The direct child of application constructor, without attribute **autoAttach** as `false`, will be set as the [root](#) of the application instance. If more direct nested constructors are defined, only the last one will be selected.

router

A shortcut to create a Restlet Router. A router constructor can have one or more nested children. Each child will be attached to the router by calling `Router.attach` method.

filter

A shortcut to create a Restlet Filter.

Attributes

- **before**: a closure to be called when `Filter.beforeHandle` is called;
- **after**: a closure to be called when `Filter.afterHandle` is called;
- **handle**: a closure to be called when `Filter.doHandle` is called;

redirector

A shortcut to create a Restlet Redirector.

guard

A shortcut to create a Restlet Guard.

Attributes

- **scheme**: the challenge scheme, will use `ChallengeScheme.valueOf("None")` if no **scheme** is provided;
- **realm**: the authentication realm

directory

A shortcut to create a Restlet Directory. A directory constructor can not nest child.

Attributes:

- **root**: the root uri of the Directory

resource

A shortcut to create a Restlet Resource. A resource constructor can not nest child; and it can be nested in filter and router.

Attributes

`resource` constructor provides a set of closure attributes for easily handling RESTful calls.

- **store**: for handling **HTTP PUT** method
- **remove**: for handling **HTTP DELETE** method
- **accept**: for handling **HTTP POST** method
- **represent**: for handling **HTTP GET** method
- **head**: for handling **HTTP HEAD** method

- **options**: for handling **HTTP OPTIONS** method

These closures are only effected when no **ofClass** and **ofBean** attribute is specified.

RestletTutorialExamples

This page last changed on Feb 28, 2008 by [keke](#).

Examples of how to construct Restlet applications mentioned in [Restlet Tutorials](#)

For example groovy scripts, see <http://svn.codehaus.org/groovy-contrib/groovyrestlet/trunk/src/test/groovy/org/lpny/groovyrestlet/examples/tutorials/>

[Example of Part02](#)

Example about creating a [Restlet Client](#) instance.

You can use **shortcut** `client` constructor as shown in ``#1``; also you can use the generic `restlet` constructor to create client instance.

✔ you can use `restlet(ofClass:class name)`` to create any instance of derived type of [Restlet](#). In this case, you need to specify attribute `consArgs`` which are an array of constructing parameters.

Create client

```
//#1 using shortcut
builder.client(protocol.HTTP)

//#2 generic restlet constructor
builder.restlet(ofClass:"org.restlet.Client", consArgs:[protocol.HTTP] as Object[])
```

[Example of Part03](#)

At current moment, server construction does not support `restlet` way

Nesting here indicates a parent-child relationship.

✔ The child of a `server` component becoming the [target](#) property of the [Server](#).

Create a server

```
builder.server(protocol:protocol.HTTP,port:8182){
  restlet(handle:{req, resp->
    resp.setEntity("Hello World", mediaType.TEXT_PLAIN)
  })
}.start()
//or you can define restlet first
def restlet = builder.restlet(handle:{req, resp->
  resp.setEntity("Hello World", mediaType.TEXT_PLAIN)
})
builder.server(protocol:protocol.HTTP,port:8182, target:restlet).start()
```

[Example of Part05](#)

Restlet example

```
//using component shortcut constructor
def component = builder.component{
  current.servers.add(protocol.HTTP, 8182)

  restlet(uri:"/trace", handle: {req, resp->
    println "To process request: ${req}"
    def message = ""
    message += "Resource URI: ${req.resourceRef}
    Root URI : ${req.rootRef}
    Routed part : ${req.resourceRef.baseRef}
    Remaining part: ${req.resourceRef.remainingPart}
    ""
    resp.setEntity(message, mediaType.TEXT_PLAIN)
  })
}
```

[Example of Part06](#)

Serving static files

```
def ROOT_URI = ""
builder.component{
current.servers.add(protocol.HTTP, 8182)
current.clients.add(protocol.FILE)
application(uri:"") {
directory(root:ROOT_URI)
}
}.start()
```

[Example of Part09](#)

 Using `current` to reference to the current instance.

By default any nested component will be automatically attached to its parent component according to their parent-child relationship. Here [Guard](#) is automatically attached to its parent ([Application](#) here) as its [root](#). Adding attribute `autoAttach:false` can disable this feature.

Guard

```
builder.component{
current.servers.add(protocol.HTTP, 8182)
application(uri:"") {
guard(scheme:challengeScheme.HTTP_BASIC,
realm:"Tutorial").secrets.put("scott","tiger".toCharArray())
def dir = directory(autoAttach:false, root:"")
current.root.next=dir
}
}.start()
```

[Example of Part10](#)

In Restlet, an attaching operation (on `Router.attach`) returns an instance of [Route](#). It might be needed to do some post processing on a route. Attribute `postAttach` which refers a [closure](#) is used to support this.

Redirector example

```
builder.component{
current.servers.add(protocol.HTTP, 8182)
application(uri:""){
def router = router{
def target = "http://www.google.com/search?q= {keywords}"
redirector(uri:"/search",targetTemplate:target,
mode:redirectorMode.MODE_CLIENT_TEMPORARY,
postAttach:{route->
route.extractQuery("keywords","kwd",true)
})
}
}
}.start()
```

[Example of Part11](#)

 You can implement the [handle method](#) of a [Restlet](#) using a groovy closure.

Router

```
builder.component{
current.servers.add(protocol.HTTP, 8182)

application(uri:""){
router{
```

```

def guard = guard(uri: "/docs", scheme: challengeScheme.HTTP_BASIC, realm: "Restlet Tutorials")
guard.secrets.put("scott", "tiger".toCharArray())
guard.next = directory(root: "", autoAttach: false)
restlet(uri: "/users/ {user}", handle: {req, resp->
resp.setEntity("Account of user \"${req.attributes.get('user')}\", mediaType.TEXT_PLAIN)
})

restlet(uri: "/users/{user}/orders", handle: {req, resp->
resp.setEntity("Orders or user \"${req.attributes.get('user')}\", mediaType.TEXT_PLAIN)
})
restlet(uri: "/users/{user}/orders/{order}", handle: {req, resp->
def attrs = req.attributes
def message = "Order \"${attrs.get('order')}\", for User \"${attrs.get('user')}\", \"
resp.setEntity(message, mediaType.TEXT_PLAIN)
})
}
}
}.start()

```

Example of Part12

Same as handle closure of a Restlet, you can implement a simple [Restlet Resource](#) using groovy closures. Following attributes are supported:

- **init:** init method
- **represent:** for `represent()` and `represent(Variant)` methods **HTTP GET**
- **store:** for `storeRepresentation()` method **HTTP PUT**
- **remove:** for `remoteRepresentation()` method **HTTP DELETE**
- **accept:** for `acceptRepresentation()` method **HTTP POST**
- **head:** for `handleHead()` method
- **options:** for `handleOptions` method

 Specify `self` parameter in the last of parameter list. This special `self` instance indicates the resource instance.

Resources

```

builder.component{
current.servers.add(protocol.HTTP, 8182)

application(uri: ""){
router{
resource("/users/{user}",
init:{ctx, req, resp, self->
self.getVariants().add(new Variant(mediaType.TEXT_PLAIN))
},
represent:{variant, self->
return new StringRepresentation( "Account of user \"${
self.request.attributes.get('user')}\".toString(),
mediaType.TEXT_PLAIN);
})
resource("/users/{user}/orders", ofClass:OrdersResource)
}

}.start()

```

SpringIntegrationExamples

This page last changed on Feb 28, 2008 by [keke](#).

Example the spring integration

Integrating with Spring using Groovy-Restlet is straightforward.

Using ofBean attribute

```
def comp = builder.component(){
application(uri:""){
router{
resource(uri:"/users/{user}", ofBean:"userResource")
}
}
}

comp.servers.add(protocol.HTTP, 8182)
```

The bean `userResource` is defined spring definition file as followed:

```
<bean id="userResource" class="org.lpny.groovyrestlet.example.spring.UserResource"
scope="prototype" />
```

Using ofClass attribute

```
def comp = builder.component(){
application(uri:""){
router{
resource(uri:"/orders", ofClass:"org.lpny.groovyrestlet.example.spring.OrdersResource")
}
}
}

comp.servers.add(protocol.HTTP, 8182)
```

If spring context is specified when creating `GroovyRestlet` instance, Spring's [AutowireCapableBeanFactory](#) will be used to create that instance and autowire all necessary properties.

GroovySWT

This page last changed on Apr 10, 2008 by [frank.tolstrup](#).

GroovySWT is a wrapper around SWT, the eclipse Standard Widget Toolkit. It allows you to easily write Eclipse [SWT](#) applications by using Groovy's *builder* mechanism. Here is some SWT code using native Groovy:

```
import org.eclipse.swt.SWT
import org.eclipse.swt.widgets.*
import org.eclipse.swt.layout.RowLayout as Layout

def display = new Display()
def shell = new Shell(display)

shell.layout = new Layout(SWT.VERTICAL)

shell.text = 'Groovy / SWT Test'

def label = new Label(shell, SWT.NONE)
label.text = 'Simple demo of Groovy and SWT'
shell.defaultButton = new Button(shell, SWT.PUSH)
shell.defaultButton.text = '  Push Me  '

shell.pack()
shell.open()

while (!shell.disposed) {
if (!shell.display.readAndDispatch()) shell.display.sleep()
}
```

When you run this (see below for setup details), the result looks like:

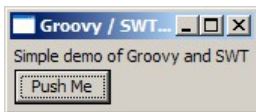

Here is the same example using SwtBuilder - note that this example does more because it actually prints some text 'Hello' to standard output when you press the button:

```
import org.eclipse.swt.SWT
import org.eclipse.swt.widgets.*

def swt = new groovy.swt.SwtBuilder()
def shell = swt.shell(text:'Groovy / SWT Test') {
rowLayout()
label(style:"none", text:'Simple demo of Groovy and SWT')
button(style:"push", text:'  Push Me  ') {
onEvent(type:"Selection", closure:{ println "Hello" })
}
}

shell.pack()
shell.open()

while (!shell.disposed) {
if (!shell.display.readAndDispatch()) shell.display.sleep()
}
```

Here is another example which explicitly creates a script class and assumes *guiBuilder* is passed in via a binding:

```
package com.dacelo.guidedsales.ui

class About extends Script {
run() {
```



```
def subapp = guiBuilder.shell( parent ) {
  GridLayout()
  group( text:"Groovy SWT", background:[255, 255, 255] ) {
    GridLayout()
    label( text:"groove fun !" ,background:[255, 255, 255] )
    label( text:"Email: ckl@dacelo.nl", background:[255, 255, 255] )
  }
}
subapp.pack()
subapp.open()
}
```

Examples

For a short example of using the JFace builder for creating a standard application see the [TextEditor sample](#).

For a comparison of the groovy and java code see [here](#) or see the latest code in subversion.

Further information

The sources (and README.txt telling you how to set up the libraries and dll's) can be found in subversion:

- [groovy-swt](#)

The jar file compiled against Eclipse SDK 3.3 jars can be found attached:

- [groovy-swt-0.3.jar](#)

To run groov-swt application you also need some of the eclipse libraries, so download [groovy-swt-0.3-including-Eclipse-libs.ZIP](#) and unzip all the jar files into the lib directory of your groovy installation.

A sample application

This page last changed on Mar 26, 2008 by [frank.tolstrup](#).

I have added a couple of applications in the example directory that can be used as a template for building other applications.

Here is an extract from a basic `TextEditor` that shows how to use the `JFace` builder:

```
mainapp = jface.applicationWindow( title:"Groovy Text Editor", location:[100,100], size:[500,
300] ) {
  GridLayout(numColumns:1)
  menuManager( text:"File" ) {
    action ( text:"Exit", closure:{ mainapp.close() } )
  }

  menuManager( text:"Edit" ) {
    action ( text:"Cut", accelerator: SWT.MOD1 + (int) 'X', closure:{ handleCutCopy(); text.cut() } )
    action ( text:"Copy", accelerator: SWT.MOD1 + (int) 'C',closure:{ handleCutCopy(); text.copy() } )
    action ( text:"Paste", accelerator: SWT.MOD1 + (int) 'P',closure:{ text.paste() } )
    separator()
    action ( text:"Set Font", closure:{ setFont() } )
  }
  toolBar( style:"none" ) {
    boldButton = toolItem(style:"check", toolTipText:"Bold") {
      image( src:"src/examples/groovy/swt/examples/TextEditor/bold.png" )
      onEvent(type:"Selection", closure:{setStyle(it.widget)})
    }
    italicButton = toolItem(style:"check", toolTipText:"Italic") {
      image( src:"src/examples/groovy/swt/examples/TextEditor/italic.png" )
      onEvent(type:"Selection", closure:{setStyle(it.widget)})
    }
    underlineButton = toolItem(style:"check", toolTipText:"Underline") {
      image( src:"src/examples/groovy/swt/examples/TextEditor/underline.png" )
      onEvent(type:"Selection", closure:{setStyle(it.widget)})
    }
    strikeoutButton = toolItem(style:"check", toolTipText:"Strikeout") {
      image( src:"src/examples/groovy/swt/examples/TextEditor/strikeout.png" )
      onEvent(type:"Selection", closure:{setStyle(it.widget)})
    }
    toolItem(style:"separator")
    toolItem(style:"push", toolTipText:"Red text") {
      image( src:"src/examples/groovy/swt/examples/TextEditor/red.png" )
      onEvent(type:"Selection", closure:{fgColor(RED)})
    }
    toolItem(style:"push", toolTipText:"Blue text") {
      image( src:"src/examples/groovy/swt/examples/TextEditor/blue.png" )
      onEvent(type:"Selection", closure:{fgColor(BLUE)})
    }
    toolItem(style:"push", toolTipText:"Green text") {
      image( src:"src/examples/groovy/swt/examples/TextEditor/green.png" )
      onEvent(type:"Selection", closure:{fgColor(GREEN)})
    }
    toolItem(style:"separator")
    toolItem(style:"push", toolTipText:"Clear formatting") {
      image( src:"src/examples/groovy/swt/examples/TextEditor/erase.png" )
      onEvent(type:"Selection", closure:{clear()})
    }
  }
}

text = styledText ( style: "Border, Multi, V_Scroll, H_Scroll" ) {
  gridData(horizontalAlignment: GridData.FILL,
verticalAlignment: GridData.FILL,
grabExcessHorizontalSpace: true,
grabExcessVerticalSpace: true
)
}
```

```
text.addExtendedModifyListener(this)
}
```

Simple isn't it? 😊

For the complete code see [subversion](#) or the attached snapshot.

groovy-swt - Comparing the java and the groovy code

This page last changed on Mar 26, 2008 by [frank.tolstrup](#).

To show how to use the the JFace builder I converted a couple of applications from the standard SWT example set:

- **TextEditor:** A simple application showing how to use menubar, toolbar and a StyledText.
- **AddressBook:** A more complete application with a simple addressbook. Shows how to use toolbars, tables, sorting, Search dialogs, editing, copy/paste

I have on purpose changed the application code as little as possible (only to make work in Groovy), and with the main focus to change the creation of the GUI to show how to use the JFace builder. But it also shows how much easier it is to use the JFace builder.

Here is the extract from the groovy code (63 lines):

```
mainapp = jface.applicationWindow( title:"Groovy Text Editor", location:[100,100], size:[500,
300] ) {
  GridLayout(numColumns:1)
  menuManager( text:"File" ) {
    action ( text:"Exit", closure:{ mainapp.close() } )
  }

  menuManager( text:"Edit" ) {
    action ( text:"Cut", accelerator: SWT.MOD1 + (int) 'X', closure:{ handleCutCopy(); text.cut() } )
    action ( text:"Copy", accelerator: SWT.MOD1 + (int) 'C',closure:{ handleCutCopy(); text.copy() } )
    action ( text:"Paste", accelerator: SWT.MOD1 + (int) 'P',closure:{ text.paste() } )
    separator()
    action ( text:"Set Font", closure:{ setFont() } )
  }
  toolBar( style:"none" ) {
    boldButton = toolItem(style:"check", toolTipText:"Bold") {
      image( src:"src/examples/groovy/swt/examples/TextEditor/bold.png" )
      onEvent(type:"Selection", closure:{setStyle(it.widget)})
    }
    italicButton = toolItem(style:"check", toolTipText:"Italic") {
      image( src:"src/examples/groovy/swt/examples/TextEditor/italic.png" )
      onEvent(type:"Selection", closure:{setStyle(it.widget)})
    }
    underlineButton = toolItem(style:"check", toolTipText:"Underline") {
      image( src:"src/examples/groovy/swt/examples/TextEditor/underline.png" )
      onEvent(type:"Selection", closure:{setStyle(it.widget)})
    }
    strikeoutButton = toolItem(style:"check", toolTipText:"Strikeout") {
      image( src:"src/examples/groovy/swt/examples/TextEditor/strikeout.png" )
      onEvent(type:"Selection", closure:{setStyle(it.widget)})
    }
    toolItem(style:"separator")
    toolItem(style:"push", toolTipText:"Red text") {
      image( src:"src/examples/groovy/swt/examples/TextEditor/red.png" )
      onEvent(type:"Selection", closure:{fgColor(RED)})
    }
    toolItem(style:"push", toolTipText:"Blue text") {
      image( src:"src/examples/groovy/swt/examples/TextEditor/blue.png" )
      onEvent(type:"Selection", closure:{fgColor(BLUE)})
    }
    toolItem(style:"push", toolTipText:"Green text") {
      image( src:"src/examples/groovy/swt/examples/TextEditor/green.png" )
      onEvent(type:"Selection", closure:{fgColor(GREEN)})
    }
    toolItem(style:"separator")
    toolItem(style:"push", toolTipText:"Clear formatting") {
      image( src:"src/examples/groovy/swt/examples/TextEditor/erase.png" )
      onEvent(type:"Selection", closure:{clear()})
    }
  }
}
```

```

text = styledText ( style: "Border, Multi, V_Scroll, H_Scroll" ) {
gridData(horizontalAlignment: GridData.FILL,
verticalAlignment: GridData.FILL,
grabExcessHorizontalSpace: true,
grabExcessVerticalSpace: true
)
}

text.addExtendedModifyListener(this)
}
mainapp.menuBarManager.updateAll( true )
mainapp.open()
}

```

And here is the extract from the java code (175 lines)

```

Menu createEditMenu() {
Menu bar = shell.getMenuBar ();
Menu menu = new Menu (bar);

MenuItem item = new MenuItem (menu, SWT.PUSH);
item.setText (resources.getString("Cut_menuitem"));
item.setAccelerator(SWT.MOD1 + 'X');
item.addSelectionListener(new SelectionAdapter() {
public void widgetSelected(SelectionEvent event) {
handleCutCopy();
text.cut();
}
});
item = new MenuItem (menu, SWT.PUSH);
item.setText (resources.getString("Copy_menuitem"));
item.setAccelerator(SWT.MOD1 + 'C');
item.addSelectionListener(new SelectionAdapter() {
public void widgetSelected(SelectionEvent event) {
handleCutCopy();
text.copy();
}
});
item = new MenuItem (menu, SWT.PUSH);
item.setText (resources.getString("Paste_menuitem"));
item.setAccelerator(SWT.MOD1 + 'V');
item.addSelectionListener(new SelectionAdapter() {
public void widgetSelected(SelectionEvent event) {
text.paste();
}
});
new MenuItem (menu, SWT.SEPARATOR);
item = new MenuItem (menu, SWT.PUSH);
item.setText (resources.getString("Font_menuitem"));
item.addSelectionListener(new SelectionAdapter() {
public void widgetSelected(SelectionEvent event) {
setFont();
}
});
return menu;
}

Menu createFileMenu() {
Menu bar = shell.getMenuBar ();
Menu menu = new Menu (bar);

MenuItem item = new MenuItem (menu, SWT.PUSH);
item.setText (resources.getString("Exit_menuitem"));
item.addSelectionListener(new SelectionAdapter() {
public void widgetSelected(SelectionEvent event) {

```

```

shell.close ();
}
});

return menu;
}

void createMenuBar () {
Menu bar = new Menu (shell, SWT.BAR);
shell.setMenuBar (bar);

MenuItem fileItem = new MenuItem (bar, SWT.CASCADE);
fileItem.setText (resources.getString("File_menuitem"));
fileItem.setMenu (createFileMenu ());

MenuItem editItem = new MenuItem (bar, SWT.CASCADE);
editItem.setText (resources.getString("Edit_menuitem"));
editItem.setMenu (createEditMenu ());
}

void createShell (Display display) {
shell = new Shell (display);
shell.setText (resources.getString("Window_title"));
images.loadAll (display);
GridLayout layout = new GridLayout();
layout.numColumns = 1;
shell.setLayout(layout);
shell.addDisposeListener (new DisposeListener () {
public void widgetDisposed (DisposeEvent e) {
if (font != null) font.dispose();
images.freeAll ();
RED.dispose();
GREEN.dispose();
BLUE.dispose();
}
});
}

void createStyledText() {
initializeColors();
text = new StyledText (shell, SWT.BORDER | SWT.MULTI | SWT.V_SCROLL | SWT.H_SCROLL);
GridData spec = new GridData();
spec.horizontalAlignment = GridData.FILL;
spec.grabExcessHorizontalSpace = true;
spec.verticalAlignment = GridData.FILL;
spec.grabExcessVerticalSpace = true;
text.setLayoutData(spec);
text.addExtendedModifyListener(new ExtendedModifyListener() {
public void modifyText(ExtendedModifyEvent e) {
handleExtendedModify(e);
}
});
}

void createToolBar() {
toolBar = new ToolBar(shell, SWT.NONE);
SelectionAdapter listener = new SelectionAdapter() {
public void widgetSelected(SelectionEvent event) {
setStyle (event.widget);
}
};
boldButton = new ToolItem(toolBar, SWT.CHECK);
boldButton.setImage(images.Bold);
boldButton.setToolTipText(resources.getString("Bold"));
boldButton.addSelectionListener(listener);
italicButton = new ToolItem(toolBar, SWT.CHECK);
italicButton.setImage(images.Italic);
}

```

```

italicButton.setToolTipText(resources.getString("Italic"));
italicButton.addSelectionListener(listener);
underlineButton = new ToolItem(toolBar, SWT.CHECK);
underlineButton.setImage(images.Underline);
underlineButton.setToolTipText(resources.getString("Underline"));
underlineButton.addSelectionListener(listener);
strikeoutButton = new ToolItem(toolBar, SWT.CHECK);
strikeoutButton.setImage(images.Strikeout);
strikeoutButton.setToolTipText(resources.getString("Strikeout"));
strikeoutButton.addSelectionListener(listener);

ToolItem item = new ToolItem(toolBar, SWT.SEPARATOR);
item = new ToolItem(toolBar, SWT.PUSH);
item.setImage(images.Red);
item.addSelectionListener(new SelectionAdapter() {
public void widgetSelected(SelectionEvent event) {
fgColor(RED);
}
});
item = new ToolItem(toolBar, SWT.PUSH);
item.setImage(images.Green);
item.addSelectionListener(new SelectionAdapter() {
public void widgetSelected(SelectionEvent event) {
fgColor(GREEN);
}
});
item = new ToolItem(toolBar, SWT.PUSH);
item.setImage(images.Blue);
item.addSelectionListener(new SelectionAdapter() {
public void widgetSelected(SelectionEvent event) {
fgColor(BLUE);
}
});
item = new ToolItem(toolBar, SWT.SEPARATOR);
item = new ToolItem(toolBar, SWT.PUSH);
item.setImage(images.Erase);
item.addSelectionListener(new SelectionAdapter() {
public void widgetSelected(SelectionEvent event) {
clear();
}
});
}

public static void main (String [] args) {
Display display = new Display ();
TextEditor example = new TextEditor ();
Shell shell = example.open (display);
while (!shell.isDisposed ())
if (!display.readAndDispatch ()) display.sleep ();
display.dispose ();
}

public Shell open (Display display) {
createShell (display);
createMenuBar ();
createToolBar ();
createStyledText ();
shell.setSize(500, 300);
shell.open ();
return shell;
}

```

So basically the groovy code is about 1/3 of the java code and a lot more readable.

For the complete code see the attachment or [subversion](#).

GroovyWS

This page last changed on Apr 21, 2008 by [galleon](#).

Module Overview

GroovyWS is taking over [GroovySOAP](#) as [CXF](#) replaces [XFire](#). The major difference here is that GroovyWS is using Java5 so if you need to stick to 1.4 please continue to use GroovySOAP.

Warning: Most of the documentation is adapted from the former GroovySOAP documentation and will improve in the future. I tried to make it as accurate as possible but feel free to report any error.

Warning: GroovyWS is Java5 dependent (due to CXF) and has been tested using groovy-1.5.

Warning: In order to use GroovyWS, you must ensure that GroovySOAP is not in your classpath (~/.groovy/lib)

Download

Distributions

GroovyWS is available in two packages:

- as a full jar containing all CXF JARs and dependencies. It is located [here](#)
- as a jar containing all except the jetty server and servlet files. It aimed at being deployed into third party containers. It is located [here](#)

Installing

You just need to place the above mentioned JAR file in your `${user.home}/.groovy/lib` directory.

Pre-requisites

As the pre-requisites are quite tricky to handle, an all-in-one JAR file is distributed

Documentation

Getting Started

The Server

You can develop your web service using a groovy script and/or a groovy class. The following two groovy files are valid for building a web-service.

1. MathService.groovy

```
public class MathService {
    double add(double arg0, double arg1) {
        return (arg0 + arg1)
    }
    double square(double arg0) {
        return (arg0 * arg0)
    }
}
```

2. Then the easy part ... no need for comments

```
import groovyxx.net.ws.WSServer

def server = new WSServer()

server.setNode("MathService", "http://localhost:6980/MathService")
```

That's all !

The Client

1. Oh ... you want to test it ... two more lines.

```
import groovyx.net.ws.WSClient

def proxy = new WSClient("http://localhost:6980/MathService?wsdl", this.class.classLoader)

def result = proxy.add(1.0 as double, 2.0 as double)
assert (result == 3.0)

result = proxy.square(3.0 as double)
assert (result == 9.0)
```

2. You're done!

Complex types

The Server

Let say we have a server that manage a library in which you can add a book, find a book and get all the books. The server code will probably look like this 😊

1. BookService.groovy

```
class BookService {

    private List allBooks = new ArrayList()

    Book findBook(String isbn) {
        for (book in allBooks) {
            if (book.isbn == isbn) return book
        }
        return null
    }

    void addBook(Book book) {
        allBooks.add(book)
    }

    Book[] getBooks() {
        return (Book[])allBooks.toArray(new Book[allBooks.size()])
    }

}
```

2. with the class Book being something like that.

Book.groovy

```
class Book {
    String author
    String title
    String isbn
}
```

To ignore the metaClass property a custom type mapping must be defined (for details refer to [Aegis Binding](#)).

Book.aegis.xml

```
<?xml version="1.0" encoding="UTF-8"?>
< mappings xmlns:sample="http://DefaultNamespace">
< mapping name="sample:Book">
< property name="metaClass" ignore="true"/>
</mapping>
```

```
</mappings>
```

However, if you compile custom data types from Java the bytecode won't contain a `metaClass` property and, hence, there is no need to define a custom mapping.

The Client

The good thing here is that the client does not have to know about the `Book` class. It is automatically generated during the proxy creation time and can be used by your client. Here it is located in the `defaultnamespace` package since no package was used on the server side.

Here is how the client looks like now:

```
import groovyx.net.ws.WSClient

def proxy = new WSClient("http://localhost:6981/BookService?wsdl", this.class.classLoader)

def books = proxy.getBooks()

for (book in books) println book

def book = proxy.create("defaultnamespace.Book")

book.title = "Groovy in Action"
book.author = "Dierk"
book.isbn = "123"

proxy.addBook(book)

def bks = proxy.getBooks()

println bks.books[0].isbn
```

Iterating over the books is slightly more complicated since SOAP wrap the arrays in an element (in our case `ArrayOfBook`). Therefore you have to extract a field from that element. In our case:

```
def aob = proxy.getBooks()

for (book in aob.books) println book.name
```

More Information

Using proxies

If you are using a proxy for accessing internet, you can use the following environment variables to get rid of it:

- `proxyHost`
- `proxyPort`
- `proxy.user`
- `proxy.password`

Using basic authentication

If your server use basic authentication, you need to set up the following properties:

- `http.user`
- `http.password`

TODO

If you have ideas how the API should look, do not hesitate to post on the user list ;-

Known problems (and work around)

You will not be able to create a proxy directly for a service that requires a username and password to fetch the WSDL. One alternate way is to download the WSDL (using wget or curl with the username and password set) and to create the proxy using the local file.

Demos with public web services

Currency rate calculator

There exist a lot of web-services available for testing. One which is pretty easy to evaluate is the currency rate calculator from webservicex.net.

Here is a small swing sample that demonstrate the use of the service. Enjoy !

```
import groovy.swing.SwingBuilder
import groovy.net.ws.WSClient

proxy = new WSClient("http://www.webservicex.net/CurrencyConvertor.asmx?WSDL",
this.class.classLoader)

def currency = ['USD', 'EUR', 'CAD', 'GBP', 'AUD', 'SGD']
def rate = 0.0

swing = new SwingBuilder()

refresh = swing.action(
name:'Refresh',
closure:this.&refreshText,
mnemonic:'R'
)

frame = swing.frame(title:'Currency Demo') {
panel {
label 'Currency rate from '
comboBox(id:'from', items:currency)
label ' to '
comboBox(id:'to', items:currency)
label ' is '
textField(id:'currency', columns:10, rate.toString())
button(text:'Go !', action:refresh)
}
}
frame.pack()
frame.show()

def refreshText(event) {
rate = proxy.ConversionRate(swing.from.getSelectedItemAt(), swing.to.getSelectedItemAt())
swing.currency.text = rate
}
```

TerraServer-USA by Microsoft

TerraServer supports a Tiling Web Service that enables you to build applications that integrate with USGS imagery found on their site. Here is a sample of what you can achieve.

```
import groovy.net.ws.WSClient;
def proxy = new WSClient("http://terraserice.net/TerraService.asmx?WSDL", this.class.classLoader)

// Create the Place object
def place = proxy.create("com.terraserver_usa.terraserver.Place")

// Initialize the Place object
place.city = "mountain view"
place.state = "ca"
```

```
place.country = "us"

// Geocode the place
def result = proxy.ConvertPlaceToLonLatPt(place)

println "Longitude: ${result.lon}"
println "Latitude: ${result.lat}"
```

will give:

```
Longitude: -122.08000183105469
Latitude: 37.400001525878906
```

Developers

Guillaume Alleon

Source Control

<http://svn.codehaus.org/groovy-contrib/groovyws>

Building

Contributing

Community

Mailing List(s)

use user@groovy.codehaus.org

Issue tracker

There is a [GroovyWS](#) category in JIRA

Articles

A nice article from Geertjan's blog with several examples: http://blogs.sun.com/geertjan/entry/groovy_web_service

GSP

This page last changed on Sep 02, 2007 by [brownj](#).

GSP are not maintained as a standalone module. But it has been forked and reintegrated in [Grails](#).

GSP means GroovyServer Pages, which is similar to JSP (JavaServer Pages).

GSP Module Project has started originally by Troy Heninger.

The original sources of GSP module 1.1 can be found at Groovy's [SVN](#) repository.

There is also a new GSP project page: <https://gsp.dev.java.net/>

Sample GSP: AttributeTest.gsp

```
<%
if (session.counter == null)
session.counter = 1
else
session.counter++

session.setAttribute("id", "tmpID")
session.setAttribute("uid", "userID")

request.x = 123
application.x = 500

if (application.counter == null)
application.counter = 1
else
application.counter++

%>

application.counter = ${application.counter} <br>
session.counter = ${session.counter} <br>
session.id = ${session.id} <br>
session.uid = ${session.uid} <br>
session.getAttribute('id') = ${session.getAttribute('id')} <br>
request.x = ${request.x} <br>
(application.x == null ?) = ${application.x == null} <br>
application.x = ${application.x} <br>
```

web.xml

```
<servlet>
<servlet-name>GSP</servlet-name>
<servlet-class>groovy.modules.pages.GroovyPages</servlet-class>
<init-param>
<param-name>encoding</param-name>
<param-value>ISO-8859-1</param-value>
</init-param>
<init-param>
<param-name>debug</param-name>
<param-value>0</param-value>
</init-param>
</servlet>

<servlet-mapping>
<servlet-name>GSP</servlet-name>
<url-pattern>*.gsp</url-pattern>
</servlet-mapping>
</servlet>
```

GSQL

This page last changed on Mar 20, 2008 by [standtrooper](#).

GSQL supports easier access to databases using Groovy.

Groovy has [built-in](#) SQL support. If that doesn't meet your needs, consider this module.

The source code can be found here :

- [GSQL](#)

Examples

SqlGeneratorTest.groovy

```
/**
 * Test to verify valid construction of default DDL
 *
 * @author <a href="mailto:jeremy.rayner@bigfoot.com">Jeremy Rayner</a>
 * @version $Revision: 1.2 $
 */
package org.javanicus.gsql

import java.io.*

class SqlGeneratorTest extends GroovyTestCase {
    def database
    def sqlGenerator

    void setUp() {
        def typeMap = new TypeMap()
        def build = new RelationalBuilder(typeMap)
        def sqlGenerator = new SqlGenerator(typeMap, System.getProperty( "line.separator", "\n" ))

        def database = build.database(name:'genealogy') {
            table(name:'event') {
                column(name:'event_id', type:'integer', size:10, primaryKey:true, required:true)
                column(name:'description', type:'varchar', size:30)
            }
            table(name:'individual') {
                column(name:'individual_id', type:'integer', size:10, required:true, primaryKey:true,
                    autoIncrement:true)
                column(name:'surname', type:'varchar', size:15, required:true)
                column(name:'event_id', type:'integer', size:10)
                foreignKey(foreignTable:'event') {
                    reference(local:'event_id', foreign:'event_id')
                }
            }
            index(name:'surname_index') {
                indexColumn(name:'surname')
            }
        }
    }

    void testGenerateDDL() {
        def testWriter = new PrintWriter(new FileOutputStream("SqlGeneratorTest.sql"))
        sqlGenerator.writer = testWriter
        sqlGenerator.createDatabase(database, true)
        testWriter.flush()
    }
}
```

JideBuilder

This page last changed on Feb 06, 2008 by [aalmiray](#).

JideBuilder is a Groovy builder for the open source [JIDE Common Layer](#)

Contribution Overview

JideBuilder will let you create Jide components and standard Swing components as SwingBuilder does, because it doesn't override the default names of previously registered components in SwingBuilder, this means that you can mix both types of components with the same builder.

```
def jide = new JideBuilder()
def frame = jide.frame( id: 'frame', title: 'JideBuilder' ){
panel( layout: new BorderLayout(5,5) ){
button( label: "Swing", constraints: BorderLayout.WEST )
jideButton( label: "Jide", constraints: BorderLayout.EAST )
textField( constraints: BorderLayout.NORTH )
calculator( constraints: BorderLayout.CENTER )
}
}
```

There are 5 *Searchable components that will add searching capabilities to a previously created widget or an internal one, exposing the searchable widget and the searchable wrapper if an 'id' attribute was provided, for example ComboBoxSearchable:

```
def jide = new JideBuilder()
def frame = jide.frame( id: 'frame', title: 'JideBuilder' ){
panel( layout: new BorderLayout(5,5) ){
comboBox( id: "mycombo", items: [1,2,3] )
comboBoxSearchable( id: "c1", comboBox: mycombo )
comboBoxSearchable( id: "c2", items: [4,5,6] )
}
}
assertNotNull jide.ci_searchable
```

JIDE Common Layer defines a basic structure for dialogs with StandardDialog, which is an abstract class, you may create your own dialogs based on that template by calling 'standardDialog()', by default all 3 panels will be empty, but you can provide your own content by calling 'dialogBannerPanel()', 'dialogContentPanel()' and 'dialogButtonPanel()' inside its closure.

All JTextComponents (even those created with regular SwingBuilder methods) will accept a 'selectAll' property, which will call com.jidesoft.swing.SelectAllUtils.install() on the component. SearchableBar has an additional property 'install' which will register a SearchableBar.Installer automatically into the immediate container. This property must be a Map and may have the following properties:

- constraints: must be a valid Object accepted by the container's layout (required).
- keyStroke: must be a javax.swing.KeyStroke, defaults to CTRL + F (optional).

Team Members

Andres Almiray [[aalmiray at users dot sourceforge dot net](mailto:aalmiray@users.sourceforge.net)]

Download

[jidebuilder-1.0](#)
[svg-salamander-1.0](#)

Installing

Drop jidebuilder-1.0 into \$GROOVY_HOME/lib along with its dependencies

- [jide-oss-2.2.1](#)

- [svg-salamander-1.0](#)

Pre-requisites

Groovy 1.5 is required to use JideBuilder.

Documentation

Alphabetical list of components

Element	Class	Notes
animator	Animator	
autoCompletion	AutoCompletion	Wraps an existing JComboBox with 'comboBox' attribute Wraps an existing JTextComponent with 'textComponent' attribute Will create an internal JTextField if 'textComponent' and 'comboBox' are omitted If 'textComponent' is specified (or internal JTextField is created), 'searchable' or 'list' must also be specified Additional attributes may be set on the wrapped component
autoCompletionComboBox	AutoCompletionComboBox	
autoResizingTextArea	AutoResizingTextArea	
bannerPanel	BannerPanel	
bottom		JideSwingUtilities.createBottomPanel
buttonPanel	ButtonPanel	
calculator	Calculator	
center		JideSwingUtilities.createCenterPanel
checkboxList	CheckBoxList	
checkboxListWithSelectable	CheckBoxListWithSelectable	
checkboxTree	CheckBoxTree	
clickThroughLabel	ClickThroughLabel	
comboBoxSearchable	ComboBoxSearchable	Wraps an existing JComboBox with 'comboBox' attribute Will create an internal JComboBox if 'comboBox' is omitted Additional attributes may be set on the wrapped component Obeys 'items' when creating an internal JComboBox.

contentContainer	ContentContainer	
dateSpinner	DateSpinner	
dialogBannerPanel	DialogBannerPanel (from JideBuilder)	Use it inside standardDialog
dialogButtonPanel	DialogButtonPanel (from JideBuilder)	Use it inside standardDialog
dialogContentPanel	DialogContentPanel (from JideBuilder)	Use it inside standardDialog
dialogPage	DefaultDialogPage (from JideBuilder)	Use it inside a multiplePageDialog Add a 'closure' attribute as the body of lazyInitialize() default does nothing
fileIntelliHints	FileIntelliHints	Needs 'textComponent' attribute Additional attributes may be set on the wrapped component
folderChooser	FolderChooser	
gripper	Gripper	
headerBox	HeaderBox	
jideButton	JideButton	
jideBorderLayout	JideBorderLayout	
jideBoxLayout	JideBoxLayout	
jideMenu	JideMenu	Use a closure with 'customize' attribute to create a PopupMenuConfigurer
jideOptionPane	JideOptionPane	
jidePopup	JidePopup	
jidePopupMenu	JidePopupMenu	
jideScrollPane	JideScrollPane	
jideSplitButton	JideSplitButton	Use a closure with 'customize' attribute to create a PopupMenuConfigurer
jideSplitPane	JideSplitPane	
jideTabbedPane	JideTabbedPane	
jideToggleButton	JideToggleButton	
jideToggleSplitButton	JideToggleSplitButton	Use a closure with 'customize' attribute to create a PopupMenuConfigurer
labeledTextField	LabeledTextField	

left		JideSwingUtilities.createLeftPanel
listDataIntelliHints	ListDataIntelliHints	Needs 'textComponent' and 'completionList' attributes, Additional attributes may be set on the wrapped component
listSearchable	ListSearchable	Wraps an existing JList with 'list' attribute Will create an internal JList if 'list' is ommitted Additional attributes may be set on the wrapped component
multilineLabel	MultilineLabel	
multiplePageDialog	MultiplePageDialog	
multiplePageDialogPane	MultiplePageDialogPane	
nullButton	NullButton	
nullCheckBox	NullCheckBox	
nullJideButton	NullJideButton	
nullLabel	NullLabel	
nullPanel	NullPanel	
nullRadioButton	NullRadioButton	
nullTristateCheckBox	NullTristateCheckBox	
paintPanel	PaintPanel	
pointSpinner	PointSpinner	
popupMenuCustomizer	DefaultPopupMenuCustomizer (from JideBuilder)	Use 'closure' attribute to define the body of customize()
rangeSlider	RangeSlider	
resizableDialog	ResizableDialog	
resizableFrame	ResizableFrame	
resizablePanel	ResizablePanel	
resizableWindow	ResizableWindow	
right		JideSwingUtilities.createRightPanel
searchableBar	SearchableBar	Wraps an existing Searchable with 'searchable' attribute Additional attributes may be set on the wrapped component
simpleScrollPane	SimpleScrollPane	
splitButtonGroup	SplitButtonGroup	

standardDialog	DefaultStandardDialog (from JideBuilder)	Use 'dialogBannerPanel', 'dialogContentPanel' and 'dialogButtonPanel' to provide additional configuration for each panel
styledLabel	StyledLabel	
tableSearchable	TableSearchable	Wraps an existing JTable with 'table' attribute Will create an internal JTable if 'table' is omitted Additional attributes may be set on the wrapped component
textComponentSearchable	TextComponentSearchable	Wraps an existing JTextComponent with 'textComponent' attribute Will create an internal JTextField if 'textComponent' is omitted Additional attributes may be set on the wrapped component
top		JideSwingUtilities.createTopPanel
treeSearchable	TreeSearchable	Wraps an existing JTree with 'tree' attribute Will create an internal JTree if 'tree' is omitted Additional attributes may be set on the wrapped component
tristateCheckBox	TristateCheckBox	
svgIcon	ResizableSVGIcon	<ul style="list-style-type: none"> • path: same as svgResourcePath but allows aliases • trackSize: enables/disables resizing (default: false) • resizePercentage: controls how much the icon will change size, value must be in range 10..100 (default: 100) • retainAspectRatio: controls how resizing will take effect (default: true) • size: alias for 'preferredSize'

Developers

Andres Almiray

Source Control

<http://svn.codehaus.org/groovy-contrib/jidebuilder>

Building

JideBuilder uses Maven2 as its build tool, which means that if you want to

build your own version of JideBuilder from source you'll need to have it installed. Follow the instructions at <http://maven.apache.org>
Once Maven2 is installed you will also need to install two other dependencies

- [jide-oss-2.2.1](#)
- [svg-salamander-1.0](#)

Install them on your local Maven2 repo if needed with the following command

```
mvn install:installFile -DgroupId=<group> -Dversion=<version> -Dpackaging=jar \  
-DartifactId=<depname> -Dfile=<jarfile>
```

substituting the text inside < > with the correct package, version, name and jar file.

Contributing

Please contact the team members by e-mail.

Community

Mailing List(s)

<http://groovy.codehaus.org/Mailing+Lists>

Issue tracker

<http://jira.codehaus.org/secure/BrowseProject.jspx?id=10242>

Native Launcher

This page last changed on Jan 16, 2008 by [jbaumann](#).

The groovy native launcher is a native program for launching groovy scripts. It compiles to an executable binary file, e.g. groovy.exe on windows. Note that you still need to have groovy and jre or jdk installed, i.e. the native launcher is a native executable replacement for the startup scripts (groovy.bat, groovy.sh). The native launcher is included in the groovy windows installer. For other platforms, you have to compile it yourself.

How it works

Essentially the launcher does the same thing that the normal java launcher (java executable) does - it dynamically loads the dynamic library containing the jvm and hands the execution over to it. It does not start a separate process (i.e. it does not call the java executable).

Status

The native launcher should support any platform and any jdk / jre (≥ 1.4). If you find something that is not supported, please post a JIRA enhancement request and support will be added.

At the moment, the following platforms have been tested:

- Windows (XP, Vista)
- linux (SuSE, Ubuntu) on x86
- solaris on sparc
- OS-X

At the moment, the following jdks / jres have been tested

- several versions of sun jre / jdk (from 1.4, 1.5 and 1.6 serieses)
- jrockit (on windows)

The current version of the native launcher works with any groovy version.

Pre-compiled binaries

Here are precompiled binaries for windows:

[groovy.exe](#)
[groovyw.exe](#)

They are not guaranteed to be completely up to date with the sources in svn head, but they should work.

Hopefully we will have precompiled binaries for all supported platforms in the future.

What about the other groovy executables?

The same binaries work for all the groovy executables (groovy, groovyc, groovysh...). Just copy / (soft)link to the executable w/ the name of the executable you want, e.g.

```
windows:  
copy groovy.exe groovyc.exe  
unixes:  
ln -s groovy groovyc
```

Compiling

The source code repository for the Native Launcher module resides at http://svn.codehaus.org/groovy/trunk/groovy/modules/native_launcher.

The binaries are compiled w/ the provided [rant](#) script. Just type

rant

Compiling on windows

On Windows you can either compile w/ ms cl compiler + ms link from normal windows command prompt or gcc from [cygwin](#) or [msys](#). On cygwin, you currently have to use the rant version from svn head, and run rant w/ the script rant/trunk/run_rant as the present rant release does not work w/ cygwin.

Thus the best way compiling with an open source tool chain is to use msys. To install the tool chain for msys follow these simple steps:

- Download Ruby from <http://rubyforge.org/projects/rubyinstaller/> (the one-click-installer-version)
- Install it and add Ruby to your PATH
- Download Rant from <http://rubyforge.org/projects/rant> (as a gem i.e., choose the package with .gem ending)
- Open a Cmd window, navigate to the downloaded gem and install it with the following command:
gem install rant-0.5.8.gem

[Rant is set up, now the compiler (in mingw) and bash (in msys)]

- Download the 'Automated MinGW Installer' from http://sourceforge.net/project/showfiles.php?group_id=2435&package_id=240780
- Run it (it automatically installs the needed compiler, you don't have to choose additional packages)
- Download MSYS from http://sourceforge.net/project/showfiles.php?group_id=2435&package_id=24963 (don't choose a technology preview, use the executable offered as current release)
- Run it (it install the bash and sets up the path, adding the MinGW executables to the path inherited from Windows)
- You get an icon that starts a bash
- Start the bash and navigate to where you downloaded the source code for the native launcher
- Enter the command 'rant' and watch it compile the sources.

Compiling with cygwin/mingw gcc the produced executable will not depend on any dlls that aren't found on windows by default. If you compile with ms visual studio, you will need an extra dll that may or may not be found on your windows. The dll youo need depends on the visual studio version, see [here](#) for details.

Just try to run first - if there's no complaint about a missing dll, you're fine.

Usage

To use the native launcher, you need to either place the executable in the bin directory of groovy installation OR set the GROOVY_HOME environment variable to point to your groovy installation.

The launcher primarily tries to find the groovy installation by seeing whether it is sitting in the bin directory of one. If not, it resorts to using GROOVY_HOME environment variable. Note that this means that GROOVY_HOME environment variable does not need to be set to be able to run groovy.

Finding java installation

The native launcher uses the following order to look up java installation to use:

1. user provided java home (using the -jh / --javahome parameter)
2. java installation pointed to by JAVA_HOME environment variable
3. java installation found by seeing where java executable can be found on PATH (symlinks are followed to find the actual executable)
4. java installation marked as the current version in windows registry (value of "CurrentVersion" in keys
 - HKEY_LOCAL_MACHINE SOFTWARE JavaSoft Java Development Kit
 - HKEY_LOCAL_MACHINE SOFTWARE

- JRockit
- Java Development Kit
- HKEY_LOCAL_MACHINE
 - SOFTWARE
 - JavaSoft
 - Java Runtime Environment
- HKEY_LOCAL_MACHINE
 - SOFTWARE
 - JRockit
 - Java Runtime Environment

5. hard coded "/System/Library/Frameworks/JavaVM.framework" (os-x only)

To put it another way - JAVA_HOME does not need to be set.

Parameters

The native launcher accepts all the same parameters as the .bat / shell script launchers, and a few others on top of that. For details, type

```
groovy -h
```

JVM parameters

Any options not recognized as options to groovy are passed on to the jvm, so you can e.g. do

```
groovy -Xmx250m myscript.groovy
```

The -client (default) and -server options to designate the type of jvm to use are also supported, so you can do

```
groovy -Xmx250m -server myscript.groovy
```

Note that no aliases like -hotspot, -jrockit etc. are accepted - it's either -client or -server

You can freely mix jvm parameters and groovy parameters. E.g. in the following -d is param to groovy and -Dmy.prop=foo / -Xmx200m are params to the jvm:

```
groovy -Dmy.prop=foo -d -Xmx200m myscript.groovy
```

JAVA_OPTS

The environment variable JAVA_OPTS can be used to set jvm options you want to be in effect every time you run groovy, e.g. (win example)
set JAVA_OPTS=-Xms100m -Xmx200m

You can achieve the same effect by using environment variable JAVA_TOOL_OPTIONS, see <http://java.sun.com/j2se/1.5.0/docs/guide/jvmti/jvmti.html#tooloptions> and http://java.sun.com/j2se/1.5/pdf/jdk50_ts_guide.pdf

Note that if you set the same option from the command line that is already set in JAVA_OPTS, the one given on the command line overrides the one given in JAVA_OPTS.

groovy.exe and groovyw.exe on Windows

Similarly to java.exe and javaw.exe on a jdk, the build process produces groovy.exe and groovyw.exe on windows. The difference is the same as w/ java.exe and javaw.exe - groovy.exe requires a console and will launch one if it is not started in a console, whereas groovyw.exe has no console (and is usually used to start apps w/ their own gui or that run on the background).

Windows file association

If you want to run your groovy scripts on windows so that they seem like any other commands (i.e. if you have myscript.groovy on your PATH, you can just type myscript), you have to associate groovy script files

with the groovy executable. If you use the groovy windows installer it will do this for you. Otherwise, do as follows:

- add .groovy to PATHEXT environment variable
- make changes in windows registry as follows
- run regedit.exe
- create a new key HKEY_CLASSES_ROOT\.groovy and give it the value groovyFile
- create HKEY_CLASSES_ROOT\groovyFile
- under that, create HKEY_CLASSES_ROOT\groovyFile\Shell and give it value open
- under that, create HKEY_CLASSES_ROOT\groovyFile\Shell\open\command and give it value (adjust according to your groovy location) "c:\programs\groovy-1.0\bin\groovy.exe" "%1" %*

Why?

Why have a native launcher, why aren't the startup scripts (groovy.bat, groovy.sh) sufficient? Here are some reasons:

- it solves an [open bug](#) : return value of groovy (on windows) is always 0 no matter what happens in the executed script (even if you call System.exit(1)). Granted, this could be solved by editing the launch scripts also.
- it is slightly faster than the corresponding .bat / shell script
- you can mix jvm params and groovy params, thus making it easier and more natural to e.g. reserve more memory for the started jvm.
- the process will be called "groovy", not "java". Cosmetic, yes, but still nice. =)
- fixes the problems there have been w/ the .bat launcher and paths w/ whitespace
- on Linux, you can't use an interpreted script as a #! interpreter, because of a kernel bug

Also, the launcher has been written so that the source can be used to easily create a native launcher for any Java program.

Known issues

- Paths are not converted on cygwin, so you have to use windows style paths when invoking scripts

Help wanted

If you have expertise with any of the following and want to help, please email me at antti dot karanta (at) iki dot fi:

- Cygwin c api (specifically: how to successfully load and use the win <-> posix path conversion functions when loading the cygwin1.dll from a non-cygwin c app)
- If you are running on an os that is not yet supported, please contact me and we'll make it work. You do not need c expertise, I'll just ask you some questions about the environment, then you compile after I've made the changes and make sure it works. Examples of environments I'd like someone who has them to help me out with: linux on non-x86 hardware, solaris on x86, hpux, freebsd...
- Try running on windows 2000 or 64-bit windows and tell me whether it works.

Windows NSIS-Installer

This page last changed on Sep 30, 2007 by [jbaumann](#).

A Windows-specific installation script

that allows to create installers for the different groovy versions. You can examine the results on the [download page](#).



The installer first copies the groovy files to where the user wants,



then asks for permission to create a variable GROOVY_HOME and to add the respective bin directory (%GROOVY_HOME%/bin) to the path, if no reference to groovy already exists in it.



The user can decide whether to put these into the user or system environment (on Win 95 and Win 98 this information is appended to the autoexec.bat instead) i.e., whether the installation will be for the current user or for all users. Then the installer checks for the existence of JAVA_HOME. If it doesn't exist, a message box points out the potential problem.

Next the user can decide whether or not to install the native launcher,



can decide to install additional packages,



and finally whether to associate .groovy files with the native launcher, and whether to add the extension .groovy and .gy to PATHEXT. This allows to start Groovy files from the command line directly, without having to call the groovy explicitly.



As you can see in the screen shots (they are clickable thumbnails), currently english, german, french and spanish are supported as installation languages.

Oh, and whatever you do, do not use the command line option -russel.

The french translation has been contributed by Xavier Mehaut and Tugdual Grall, the spanish translation by Andres Almiray, and the translation to brazilian portuguese has been provided by Marcos Silva Pereira.

Thank you very much.

Working with the installer source

To use the installer source to create your own binary installers, simply check it out into an Eclipse workspace. Additionally you might want to install the [NSIS-Eclipse-Plugin](#), it helps when developing NSIS stuff.

If you have worked with NSIS-scripts already there should be no big problem understanding what is done.

The main script is the file setup.nsi, where you can find the installer program. Three additional pages are defined, Variables, NativeLauncher and FileAssociation, and for each you can find the respective .ini file

containing the screen placement. Simply open them in the design editor provided by the Eclipse-Plugin, and you can see what they look like.

Two bmp-images contain the Groovy logo in different resolutions, one for the welcome page and one as header image for the other pages. The name is the game ...

Finally you have the launch scripts. These actually start the compiler with different settings for the groovy version, the groovy location (on your hard disk) and the location of the native launcher. The groovy version influences the final name of the installer.

The launch scripts are setting the following variables:

- **SOURCE_VERSION** defines the version of the release
- **SOURCE_DIR** is the full path to the groovy install directory
- **NATIVE_DIR** is the full path to the native launcher
- **SCRIPTOM_DIR** is the full path to the scriptom module
- **GANT_DIR** is the full path to the gant module
- **GRAPHICS_B** is the full path to the graphicsbuilder module
- **SWINGX_B** is the full path to the swingxbuilder module
- **VERSION_TXT** is the full path to the installed_versions.txt (this file describes the used versions)
- **DOC_DIR** is the full path to the doc directory

Most probably you only have to set these variables and you are happy to go.

Have fun.

If there is any problem whatsoever, either ask on the mailing lists or contact the author at joachim.baumann_at_xinaris.de.

Excerpt: a Windows-specific installer for Groovy

Introduction

Gosh provides an alternate way to run command-line **Groovy** scripts, as well as a simplified way to write **Windows Services (WinNT Services)** using **Groovy**. **Gosh** treats scripts the same, whether they are run from the command-line or as a service (including bindings). You can debug a service by running it from the command-line, and you can also run standard command-line **Groovy** scripts. There is very little difference between a **Groovy** script that is intended to be run as a **Windows Service** and any other **Groovy** script.

Gosh uses [JavaService](#) to do the "heavy lifting" of running a **Windows Service**. **Gosh** provides the framework that integrates command-line and service calls with **Groovy**, and a utility to configure **JavaService**. The end result is something that is a lot easier to develop with, and ultimately a lot easier to maintain, than **Windows Services** based on pure **Java** using **JavaService**.

This project has been under development since the middle of 2007, but it still should be considered beta software. Some of the details documented here are likely to change over time. We will, of course, attempt to maintain backward-compatibility as much as possible going forward. As of this writing, the following items still need to be addressed (these will be documented in Jira eventually):

- Need an installer. Manual setup is still a little more complex than I would like.
- Should use a native runner for command-line. Currently uses a batch file.
- Setting up a new **Windows Service** requires a batch file. Should support either a GUI or **Groovy** script.
- Classloader structure needs peer review (has proven to work well in testing).
- Dynamic-loading design (including folder structure conventions) needs peer review. Folder structure may still change.
- Dynamic loading of **DLLs** is still experimental at this point - has not been proven in non-sun JVMs.
- Better support for advanced logging. Currently only supports simple *stdout* and *stderr* capture to file.
- **Gosh** uses an older version of **JavaService.exe** to run **Windows Services**. Needs to be updated and tested. Proven stable through **Java 6u3**.
- Need to take a look at **JavaServiceWrapper** from TanukiSoftware as a possible replacement for **JavaService**, since it seems to have more features and also supports **Unix** daemons.
- Need to find a new name for the project. Can anyone do better than "**Gosh**?"



When installed, **Gosh** takes over as the default command-line runner for **Groovy**. This may break existing code.

Requirements

The following is required to run **Gosh**:

- 32-bit **Windows/Java (x86 architecture)** - **x64** and **IA-64** architectures are not supported
- **Java 1.5** or higher
- **Groovy 1.5** or higher (included in download)

Installation

Download the project archive and extract the files.

- [gosh-0.1.zip](#) Build 3 (1/3/2008) - Complete build including binaries, source, documentation, and examples.

Follow the installation instructions in the `.\docs\Groovy Gosh Users Guide.pdf` file.

Building from Source

Everything you need (except for ant) to build **Gosh** is included in the download. Navigate to `.\gosh\build` and run `make.bat`.

Project Structure

The **Gosh** project structure is designed to accommodate complex projects. This may include projects containing multiple **JAR** libraries and **JNI DLLs**, where different versions of the same library may exist on one machine. **Gosh** also supports convenient programmable runtime configuration using `- drumroll please` - a **Groovy** script.

One of the key differences between **Gosh** and the **Groovy** command-line tools is the emphasis on local, dynamic (runtime) project configuration. The **Gosh** project model follows a convention similar to what you would see in an application server, like a **Tomcat** web application. The standard **Groovy** command-line tools use a global configuration file that applies to all scripts. Although these tools support dynamically changing the classpath, the support is not obvious and somewhat awkward.

Conversely, in **Gosh**, there is no global configuration at all. **JAR** files (and also **DLLs**) are local to the project, and are loaded dynamically. **Gosh** also supports a local configuration script, written in **Groovy**, that lets you conditionally define external dependencies. This makes it easy to use different library versions in different projects on the same machine, something which **Groovy** isn't particularly good at at them moment. It also makes it almost foolproof to distribute an entire **Groovy**-based application to different machines (`xcopy` or `zip` the project).

Note that you can run multiple scripts from a single **Gosh** project. That includes **Windows Services**. So you can define, for example, 5 **Windows Services** and 20 utility scripts in the same project, all using the same set of **JAR** files and **DLLs**.

A **Gosh** project consists of a root folder containing the following:

- Uncompiled **Groovy** scripts, class files, properties files, and other resources.
- (optional) A `.\GROOVY-INF` folder, containing any of the following:
 - (optional) A `.\lib` folder containing **JAR** files. These will automatically be added to the classloader.
 - (optional) A `.\bin` folder containing additional Windows `*.DLL` files. This path is added to the beginning of the `java.library.path`, so **DLLs** in this folder override other **DLLs** on the local machine.
 - (optional) A `.\config.groovy` script. This lets you do any additional configuration, like loading external **JAR** files or setting up logging.

When you run a **Groovy** script using **Gosh**, this is what happens:

1. **Gosh** "discovers" the project root folder. **Gosh** searches upwards from the current folder, looking for a `.\GROOVY-INF` folder. The project root is handled by a single instance of **GroovyClassLoader**.
 - a. If it is found, the folder containing it becomes the project root. This affects the assumed package hierarchy of the project.
 - b. If it is not found, the folder containing the script is assumed to be the project root. Note that this means you can't reliably run **Groovy** scripts from within packages unless you define `.\GROOVY-INF!`
2. If it exists, **Gosh** loads all the **JAR** files in `.\GROOVY-INF\lib` into the system classloader.
3. If it exists, **Gosh** adds the `.\GROOVY-INF\bin` folder to the `java.library.path`.
4. If it exists, **Gosh** runs the `.\GROOVY-INF\config.groovy` script (`config.groovy` is compiled and cached, so this step actually costs very little).
5. Finally, **Gosh** runs your script.

Although it looks like a lot is going on here, the logic is actually very streamlined and fast. We've taken great pains to minimize the startup time, and the performance is generally acceptable.

Configuring a Windows Service

You can initially configure a **Windows Service** using a simple **DOS** batch file. Additional configuration is accomplished using Windows administration tools and by directly editing the **Windows Registry**. The tools are a little crude still, but none of this is very difficult. The documentation here should give you a clear understanding of what is necessary to configure and maintain a **Gosh**-based **Windows Service**.

1. Initial Configuration: DOS Batch File

To create (or recreate) a Windows Service, you will need to define a batch file. The batch file will call another batch file, **goshservice.bat**, with a set of parameters, as in the code example below. **Goshservice.bat** wraps the call to **JavaService.exe**, which requires relatively complex command line syntax.

```
SET JAVASERVICE_STUB="C:\myapp\bin\MyService.exe"  
SET SERVICE_NAME="My Service"  
SET GROOVY_SCRIPT="C:\myapp\MyService.groovy"  
SET LOGS_FOLDER="C:\myapp\logs\myservice"
```

```
C:\apps\gosh\javaservice\goshservice.bat %JAVASERVICE_STUB% %SERVICE_NAME% %GROOVY_SCRIPT%  
%LOGS_FOLDER%
```

The parameters you pass to **goshservice.bat** are defined as follows:

Parameter	Description
JAVASERVICE_STUB	Each service needs a renamed copy of JavaService.exe to function. The batch file makes a copy for you, in the location you specify, and uses it to run the service.
SERVICE_NAME	The name of the service. Must be unique.
GROOVY_SCRIPT	The groovy script to run as a service.
LOGS_FOLDER	Standard out and standard err streams will be written to this folder, as files. Note that each service needs a unique folder!

After you run your batch file, the new service will be accessible for additional configuration from the Windows **Services** tool. You can rerun the batch file with different parameters, but remember that you will have to redo the manual configuration steps each time.

2. Additional Configuration: Windows Tools

Most **Windows Services** require some additional setup. Open the **Services** tool to finish configuring the service.

- **start # Settings # Control Panel # Administrative Tools # Services**

At a very minimum, you should verify the configuration settings for the following items:

- **Description** - A description of the service.
- **Startup Type** - *Manual* or *Automatic*?
- **Log On** - The account determines what rights the service has.

Once you are done, you can start the service.

3. Advanced Configuration: The Windows Registry

Windows stores information about how to run services in the registry. If you want to play around with some of the service settings, and you are comfortable working directly with **RegEdit.exe**, you can save yourself some time and effort over recreating and reconfiguring the service each time. Note that when you change a registry setting, you will have to restart the service for it to become effective.

The following figure shows typical registry settings for the **Gosh Sample Service**, included in the sample project. You may notice a number of familiar parameters, such as the classpath and the maximum heap size. These can all be edited, and it is pretty obvious what each one means.

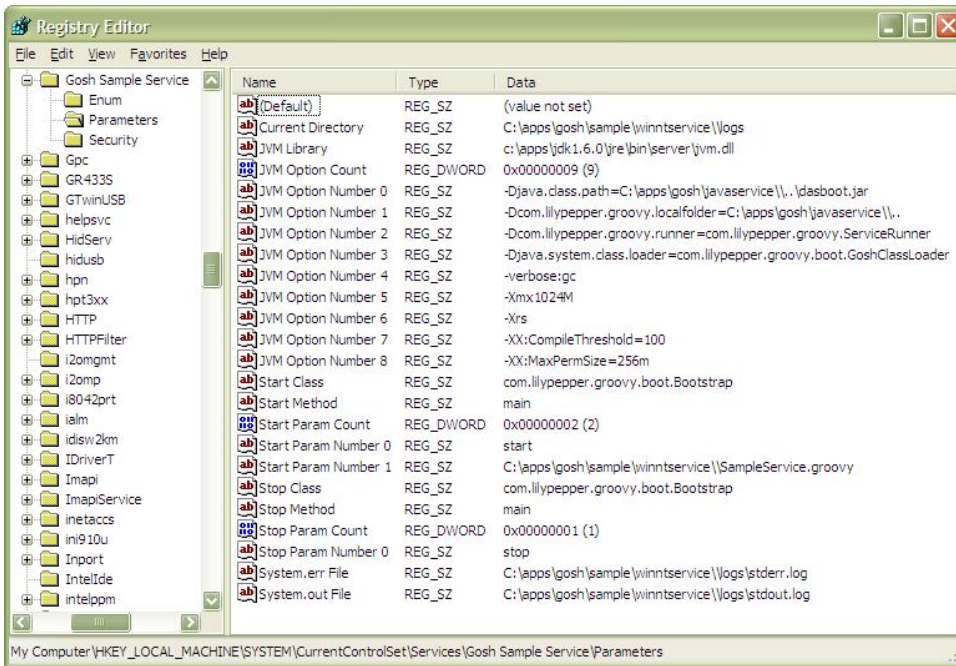

Writing a Service

At this point, you are probably wondering what the difference is between a regular **Groovy** script and **Groovy** script that runs as a **Windows Service**.

There is a difference. A **Groovy** script does a job, and when it is finished, it ends. With a **Windows Service**, the program doesn't end until Windows asks it to. You can implement this - very simply - by creating a loop that checks a flag to exit.

```
while(!service.shutdownRequested)
{
doSomethingServiceey()
service.sleep 5000 //Wait 5 seconds.
}
```

That is really all there is to it. The **service** instance is one of the bindings. **service.shutdownRequested** returns **true** when Windows has requested that the service be shutdown. **service.sleep** is a variation on **Thread.sleep()** that returns immediately if the service has been requested to shut down.

Examples

There are several examples in the **.\gosh\sample** project, included in the build.

The **wintntservice** example implements a complete **Windows Service**, ready to install and run. To use:

- Run **installsampleservice.bat** from a command-line.
- Using the **Services** tool, start the service.
- Check the log files to verify that the service is running.

There are also a few command-line examples in the same project.

Bindings

Gosh automatically creates a number of bindings. All of these are available to your script as variables, both when run as a service and when run from the command-line.

Name	Type	Description
args	List	When run from the command-line, this contains the command-line arguments. When run as a service, this is an empty list. Gosh does not support passing parameters to a service.
service	ServiceRunner	Provides state information about the service. When running from a command line, the state information never changes, so you have to shut down the process manually.
systemClassLoader	GoshClassLoader	The Java system classloader. This classloader allows you add add JAR files and new classpaths at runtime.
groovyClassLoader	GroovyClassLoader	The Groovy classloader. Note that the parent of the groovyClassLoader is the systemClassLoader .
fs	FileSystem	Supports finding the root path of your project, creating files from the root of your project (rather than the current folder) using relative paths, and changing the java.library.path , among other things.
scriptFile	File	The canonical path to the initial Groovy script.

ClassLoader Architecture

The classloader architecture in **Gosh** differs somewhat from the architecture found in other the other command-line runners for **Groovy**. **Gosh** replaces the **RootClassLoader** with the **GoshClassLoader**, which is a very simple override of **UrlClassLoader**.

Gosh is broken into two **JAR** files. The first, **dasboot.jar**, contains the minimal number of classes to boot **Gosh**. This includes the **main** entry class, the **GoshClassLoader**, and a small number of supporting classes. Once **dasboot.jar** is loaded, the system classloader gets set to an instance of **GoshClassLoader**, and all the other class libraries, including **gosh.jar**, are added to it.

Once that is done, **Gosh** creates a **GroovyClassLoader**, which is a child of the system classloader. This classloader is pointed to the root folder of the project, where it interprets uncompiled **Groovy** scripts.

In all cases, we have attempted to use the simplest, tightest classloader structure that works. This results in optimal loading and execution times.

Limitations

The following are known limitations of **Gosh**:

- You can't typically use this to bootstrap complex application servers, like **Tomcat** and **JBoss**, due to the modified classloader structure and potential conflicts with **Groovy JAR** library dependencies. If anyone has success doing this, please contact me.

WingSBuilder

This page last changed on Dec 08, 2007 by [aalmiray](#).

WingsBuilder is a Groovy builder for the [wingS Framework](#)

Contribution Overview

You can use WingSBuilder in the same fashion as [Swing Builder](#). Most of the constructs provided by the original SwingBuilder are supported in WingSBuilder, thanks to the efforts of the wingS team in following the Swing model very closely. WingSBuilder also supports wingS specific components and the ability to attach your own components through `widget()` and `container()`.

The following is an example of WingSBuilder in action

```
class GuessingGame {
    GuessingGame(){
        def randomNr = (new Random().nextInt(10) + 1) as String
        def builder = new WingSBuilder()

        /* STitledBorder was removed in wings-3.1
        def border = SBorderFactory.createSTitledBorder(
        SBorderFactory.createSLineBorder([0,0,255] as Color, 2),
        "Guessing Game")
        */
        def border = SBorderFactory.createSLineBorder([0,0,255] as Color, 2)
        def font = new SFont( null, SFont.BOLD, 14 )

        def frame = builder.frame( title: "Guessing Game" ) {
            panel( border: border){
                GridLayout( columns: 1, rows: 5, vgap: 10)
                label("Hello World - this is wingS (+WingSBuilder&Groovy)!",
                    font: font)
                label("We want fun, so let's play a game!" +
                    "Try to guess a number between 1 and 10.")
                textField( id: "answer" )
                button( text: "Guess!", actionPerformed: { event ->
                    def value = builder.answer.text
                    if( value == randomNr ){
                        builder.message.text = "Congratulations! You guessed my number!"
                    }else{
                        builder.message.text = "No - '${value}' is not the right number. Try again!"
                    }
                })
                label( id: "message" )
            }
        }

        frame.visible = true
    }
}
```

Which is rendered in FireFox as



Team Members

Andres Almiray [aalmiray at users dot sourceforge dot net]

Download

[wingsbuilder-1.0](#)

Installing

Just drop the wingsbuilder jar file along with its dependencies into your weabpp's lib directory.

Pre-requisites

WingS 3.1 and Groovy 1.5 are required to run WingSBuilder.

Documentation

Alphabetical list of SwingBuilder compatible components

Element	Class	Notes
action	javax.swing.Action	same as SwingBuilder.action()
actions	Collection	same as SwingBuilder.actions()
bean	Object	same as SwingBuilder.bean()
borderLayout	SBorderLayout	
boundedRangeModel	SDefaultBoundedRangeModel	
boxLayout	SBoxLayout	
button	SButton	
buttonGroup	SButtonGroup	
cardLayout	SCardLayout	
checkbox	SCheckbox	

closureColumn	DefaultTableColumn	same as SwingBuilder.closureColumn()
container	SComponent	placeholder for any SComponent
comboBox	SCombox	Obeys 'items' to populate model
dashedLineBorder	SBorder	
desktopPane	SDesktopPane	
dialog	SDialog	
dottedLineBorder	SBorder	
emptyBorder	SBorder	
etchedBorder	SBorder	
flowLayout	SFlowLayout	
formattedTextField	SSormattedTextField	
frame	SFrame	
gbc	GridBagConstraints	same as SwingBuilder.gbc()
gridBagConstraints	GridBagConstraints	same as SwingBuilder.gridBagConstraints()
gridBagLayout	SGridBagLayout	
gridLayout	SGridLayout	
internalFrame	SInternalFrame	
label	SLabel	
lineBorder	SBorder	
list	SList	
loweredBeveledBorder	SBorder	
loweredEtchedBorder	SBorder	
menu	SMenu	
menuBar	SMenuBar	
menuItem	SMenuItem	
map	java.util.Map	same as SwingBuilder.map()
optionPane	SOptionPane	
panel	SPanel	
passwordField	SPasswordField	
popupMenu	SPopupMenu	
progressBar	SProgressBar	

propertyColumn	DefaultTableColumn	same as SwingBuilder.propertyColumn()
radioButton	SRadioButton	
raisedBevelBorder	SBorder	
raisedEtchedBorder	SBorder	
scrollBar	SScrollBar	
scrollPane	SScrollPane	
separator	SSeparator	
spinnerDateModel	SSpinnerDateModel	
spinnerListModel	SSpinnerListModel	
spinnerNumberModel	SSpinnerNumberModel	
tabbedPane	STabbedPane	
table	STable	
tableModel	DefaultTableModel	same as SwingBuilder.tableModel()
tableColumn	STableColumn	
textArea	STextArea	
textField	STextField	
toggleButton	SToggleButton	
toolBar	SToolBar	
tree	STree	
widget	SComponent	placeholder for any SComponent

Alphabetical list of WingS specific components

Element	Class	Notes
anchor	SAnchor	
byteArrayIcon	SByteArrayIcon	
downloadButton	SDownloadButton	Must define 'resource' property at least other construction properties are 'text' & 'icon'
fileChooser	SFileChooser	
fileIcon	SFileIcon	Must define 'file' or 'filename' property at least other construction properties are 'mimetype' & 'extension'

flowDownLayout	SFlowDownLayout	
form	SForm	
imageIcon	SImageIcon	
nullLayout	SNullLayout	
pageScroller	SPageScroller	
pagingBoundedRangeModel	SPagingBoundedRangeModel	
popup	SPopup	
rawText	SRawTextComponent	
resourceIcon	SResourceIcon	
rootLayout	SRootLayout	
spacer	SSpacer	Must define 'width' & 'height' properties
templateLayout	STemplateLayout	

Alphabetical list of WingX specific components

Element	Class	Notes
calendar	XCalendar	
division	XDivision	
scrollablePanel	XScrollablePanel	
suggest	XSuggest	
treeTable	XTreeTable	
xpageScroller	XPageScroller	
xscrollPane	XScrollPane	
xtable	XTable	

Developers

Andres Almiray

Source Control

<http://svn.codehaus.org/groovy-contrib/wingsbuilder>

Building

WingSBuilder uses Maven2 as its build tool, which means that if you want to build your own version of WingSBuilder from source you'll need to have it installed. Follow the instructions at <http://maven.apache.org>
Once Maven2 is installed you will also need to install 2 files from the wingS

distribution (but it wouldn't hurt to check at <http://mvnrepository.org> if they are already there). The files are:

```
wings-3.1.jar  
wingx-3.1.jar
```

If the files are not found in any Maven2 repository the you'll need to download the source from <http://wingsframework.org>, follow the compile & install instructions, the jars should be at build/web/WEB-INF/lib
Install them on your local Maven2 repo with the following command

```
mvn install:installFile -DgroupId=org.wings -Dversion=3.1 -Dpackaging=jar \  
-DartifactId=<depname> -Dfile=<jarfile>
```

where 'depname' is any of [wings, wingx] with its corresponding jarfile

Contributing

Please contact the team members by e-mail.

Community

Mailing List(s)

<http://groovy.codehaus.org/Mailing+Lists>

Issue tracker

<http://jira.codehaus.org/secure/BrowseProject.jspx?id=10242>

XMLRPC

This page last changed on Dec 22, 2007 by [paulk_asert](#).

What is the XMLRPC module?

This is a module which allows you to create a local XML-RPC server and/or to make calls on remote XML-RPC servers.

What is XML-RPC?

[XML-RPC](#) is a spec and a set of implementations that allow software running on disparate operating systems, running in different environments to make procedure calls over the Internet. It uses HTTP as the transport and XML as the encoding. XML-RPC is designed to be as simple as possible while allowing complex data structures to be transmitted, processed and returned.

Using XMLRPC

Here is an example:

The Server

It's really easy to set up a server which provides a set of remotely callable functions.

1. Create a server object

```
import groovy.net.xmlrpc.*
import java.net.ServerSocket
```

```
def server = new XMLRPCServer()
```

2. Add some methods

```
server.echo = {return it} // the closure is now named "echo" and is remotely callable
```

3. Start the server

```
def serverSocket = new ServerSocket() // Open a server socket on a free port
server.startServer(serverSocket) // Start the XML-RPC server listening on the server
socket
```

4. You're done!

The Client

It's pretty easy to make the remote calls too

1. Create a proxy object to represent the remote server

```
def serverProxy = new XMLRPCServerProxy("http://localhost:${serverSocket.getLocalPort()}")
```

2. Call the remote method via the proxy

```
println serverProxy.echo("Hello World!")
```

3. That's all you need

More information

The sources can be found here : [XML-RPC](#).

For a binary download, go to the [repository](#).

If you are using maven to download your dependencies, you won't find all the dependencies in the Maven 2 Repo yet.

The missing dependency (smack) can be manually downloaded from [here](#).

Sample scripts

- [Confluence Example](#) showing how to download a secured Confluence page.
- Another example inspired by Glen's Confluence example:

```
import groovy.net.xmlrpc.*

def c = new XMLRPCServerProxy("http://docs.codehaus.org/rpc/xmlrpc")
def token = c.confluence1.login("your_username","your_password")
// print all the code snippets from the Groovy Home page
def page = c.confluence1.getPage(token, "Groovy", "Home")
def incode = false
def separator = '////////////////////////////////////'
page.content.split('\n').each{
if (it =~ /\{code\}/) {
incode = !incode
if (incode) println separator
return
}
if (incode) print it
}
println separator
```

Which results in (at least around December 2007) the following:

```
////////////////////////////////////
def name='World'; println "Hello $name!"
////////////////////////////////////
class Greet {
def name
Greet(who) { name = who[0].toUpperCase() +
who[1..-1] }
def salute() { println "Hello $name!" }
}

g = new Greet('world') // create object
g.salute() // Output "Hello World!"
////////////////////////////////////
import static org.apache.commons.lang.WordUtils.*

class Greeter extends Greet {
Greeter(who) { name = capitalize(who) }
}

new Greeter('world').salute()
////////////////////////////////////
groovy -e "println 'Hello ' + args[0]" World
////////////////////////////////////
```

News and Further Information

This page last changed on May 03, 2007 by paulk_asert.

- [Books](#)
 - [GinA Additional Information](#)
- [buzz around Groovy in the blogosphere](#)
- [Groovy 1.0 parties](#)
- [Groovy Series](#)
- [latest posts from our mailing-lists](#)
- [PLEAC Examples](#)

- [AboutGroovy](#): The community portal news site about everything Groovy and Grails, with frequent news items, podcast interviews, pointers to important resources.
- [GroovyBlogs](#): A JavaBlog-like news aggregator for the Groovy and Grails mailing-lists feeds, and many feeds from famous bloggers spreading the Groovy and Grails love.
- [GroovyQuizz](#): Groovy quizz are provided on a regular basis, like simple intellectual puzzles, but with Groovy solution.

Books

This page last changed on Jan 15, 2008 by [paulk_asert](#).

Groovy in Action

The [Manning book page](#) leads to all the online resources about the book like

- the table of contents
- free chapters
- reader's forum
- errata

Please note that the PDF/ebook version of the book is only available via the [Manning book page](#).

The [Amazon page](#) allows for quickly buying the book.

There also is a German edition of the book called "Groovy im Einsatz".

You can find it at [Amazon DE](#) and on the [Hanser publishing site](#) where you can also get the PDF/ebook version.



Read the news feed about Groovy in Action

 [Dierk Koenig's Amazon Blog](#)
(Dierk Koenig's Amazon Blog)

[Groovy in Action rocks the house](#)

A lot has happened around Groovy since my last post.

First of all: Groovy has won the [JAX Innovation Award 2007](#)! This european prize honors the most important innovation for the Java platform in the last year, criteria being innovation, creativity, elegance, and practical relevance. Together with the prize comes a donation of EUR 10'000.- to the Groovy project.

I must say that the Groovy is not only proud but also very thankful for the recognition of our effort and all the great feedback from our friends like the [JetBrains IntelliJ IDEA team](#).

The next big event was [JavaOne](#) in San Francisco, where numerous talks and events around Groovy and Grails took place. My co-author Guillaume Laforge and myself delivered a [Groovy talk](#) with huge success. The 600-seats room was not big enough to accommodate all interested parties and a long queue before the door was refused to enter.

Right after that, a [booksigning event](#) was scheduled for 30 minutes that had to be extended to one hour to satisfy all wishes for autographs.

Groovy in Action [sold extremely well](#) at the conference, finishing #5 in the overall bestseller list even though it was available only half of the time.

Since JavaOne, more reviews of the book have been published.

Burk Hufnagel reviews Groovy in Action on [JavaLobby](#) with the best possible rating in all categories.

Some quotes from the review:

"If you're a Java developer, or new Groovy developer, who is interested in becoming proficient in Groovy, this book is for you. And if you're not interested, you should be."

"Groovy in Action is an excellent book and I highly recommend it. It's comprehensive and written to be read."

"Do yourself a favor: buy the book, download Groovy, and have a blast."

Pan Pantziarka reviews Groovy in Action on [RegDeveloper](#) with verdict "highly recommended". Quote:

"Aside from the intrinsic interest in the subject matter, it has to be said that this is a book that is very readable, engaging, and does a great job of slotting Groovy into the broader world of software development."

Here are some more voices from the blogosphere:

[O'Reilly radar](#):

The noticeable trend with the mid-minor languages is that Groovy came from nowhere and has now sold 1500 copies in the first quarter of 2007.

[Dielehy](#)

From all accounts the Groovy and Grails books at JavaOne were literally flying off of the shelves, they ran out several times (I personally have been waiting for Groovy In Action since I first heard about it).

[Paul](#)

To get started, I bought the Groovy in Action book. This is very well written and was easy to work through, and covered so much information I think I'll be going back through it many times.

keep groovin' everybody

Dierk König

[Meet the author and hear voices about Groovy in Action](#)

Whoever would like to meet me (Dierk König that is), you will find me at the following upcoming events:

- the German [JAX conference \(Wiesbaden 23.-27. April\)](#), where I will present [various talks on Groovy and Canoo WebTest](#), lead the Groovy discussion table at the ballroom event, and represent the Groovy project as it was nominated for the JAX Innovation Award.
- the [JavaOne](#) (San Francisco, 7.-13 May) technical session TS-1742: "Cool Things You Can Do with the Groovy Dynamic Language" May 8th, 10:50 am
- the digitalGuru booksigning hour at JavaOne, May 8th, 12:30 am. You may also find me occasionally at the **Canoo booth #715**
- the [Java Forum Stuttgart](#) (July 5th) with "Advanced Groovy"
- the [Expert Forum Stuttgart](#) (July 6th) with a Grails workshop

I would very much appreciate talking to you!

Concerning the reception of the Groovy in Action book, the following voices were raised lately in the blogosphere:

[Burkhardt Hufnagel](#)

It's all I'd hoped for and more.

If you're interested in learning Groovy, this is an excellent book. Just make sure you're near a machine with Groovy installed when you read it. You'll want to try out many of the code samples, just for the fun of it.

[Gregory Pierce](#)

This book should actually be called Groovy: The Definitive Guide as it will work both as an educational text and as a reference book for those developers who adopt Groovy as either a scripting language or as a primary development language for their project. The entirety of the language is covered and sections on frequently debated language features such as closures are detailed enough to allow the reader to understand the material even outside of the context of the language.

[Andres Almiray](#)

.. it's incredible how easy to grasp Groovy concepts while reading GINA, I find it hard to stop reading it .. GINA is more than an introduction to the language, it is more like a map of the current Groovy environment and its correlation to the Java ecosystem. Even the fact that the book was ultimately integrated and "tested" with Groovy to get to the final version is a testimony on Groovy's power and that the authors really know the topic =) (this may be a trend, at least I know that the Ruby book has done the same approach), congratulations to the authors and everyone involved in this fine piece of work.

[kousenit](#)

[Groovy in Action] .. has jumped to the top of my favorite technical books list.

keep groovin'

Dierk

[Groovy tutorial series and Groovy in Action reception in the blogosphere and at JavaLobby](#)

The **Groovy tutorial series** by Sven Haiges and [Groovy in Action](#) author Dierk König has released another issue. This time it is about [regular expression support in Groovy](#).

Subscribe to the [podcast](#) and improve your Groovy kung-fu while listening. The related code examples are available at [snipplr](#) tagged *groovyseries*.

What **David Black** says about Groovy in Action (2007/03/15) :

"I'm about half way through Groovy in Action and I'm really enjoying it, and despite having used early versions of Groovy for a couple of years now, I'm learning [loads of new tricks](#). This is a well written technical introduction to the language, and as with all great technical books its easy to read and doesn't get bogged down. [..]"

And here is **Victor Charlie** (2007/03/15):

"From cover to cover I commend the writing style of this book. It teaches theory and teaches it well. GinA shows the most complete, up-to-date usage of Groovy. The price of the book is worth it in just learning how cool XML can be. The Manning Books that are on my shelf are the ones I have kept and [the books I NEVER loan out](#).[..]

I just spent 2 weeks trying to embed Groovy into an ongoing java app. Funny, the lines of Groovy code kept getting shorter and shorter. [..]"

From the [David Sills Groovy in Action review](#) at [JavaLobby](#) (rated the maximum of five smileys in all categories):

"A unique aspect of the book permeates the examples: [..] This sort of guarantee of accuracy is worth its weight in gold. [..] just [clean, well-tested code](#).

And what examples! The authors have not flinched from tackling some decidedly [non-trivial issues](#) in their pursuit of examples that would really reveal the features and utility of the language. It is astonishing to see how wide a range of applications Groovy can tackle and how successfully it can simplify and clarify code that in Java could easily become prohibitively complex.

The prose style is [engaging and highly readable](#); the author's voice is never excessively prominent. This isn't a collection of opinions, but it does fairly shout excitement about the possibilities it describes. One feels it a work of proselytization in the best sense, a work that radiates an infectious enthusiasm about a new and useful discovery, and that [ignites a corresponding enthusiasm in the reader](#).[..]

This book is therefore squarely in the line of other books in Manning's distinguished "In Action" series. It will grace my bookshelf for many a year."

[InfoQ chief architect reviews Groovy in Action](#)

2007/03/08

Read what **Alexandru "mindstorm" Popescu**, [InfoQ](#) chief architect and and co-founder of the [TestNG](#) testing framework has to say about [Groovy in Action](#) in [his blog](#):

- ".. the Bible of that programming language .."
- ".. attractive and fun and entertaining .."
- ".. I must confess that I read GINA in less than 3 days, even if it has more than 600 pages (oke, I confess I haven't read it all, but for sure more than 80% of it). And not only that I got that feeling that it is so fun that [I cannot stop myself](#), but I think it fulfills all the characteristics of great and absolutely enjoyable PL book."

He closes with:

"Finally, without any fear, I would say that Groovy in Action is not just a language guide, but represents the clear, readable and enjoyable specification of Groovy (and you should definitely read it and start playing with Groovy [blink/])."

Big thanks to Alexandru for this great review and making Groovy annotations-aware such that it can be used with EJB3, Hibernate 3, TestNG, and all other frameworks that rely on annotation support.

Dierk König

[Groovy in Action 9 stars on slashdot review](#)

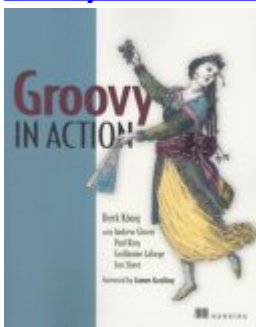

[Groovy in Action](#) was [reviewed on slashdot](#) by Simon P. Chappell.

He ranks it 9 on a scale from 1 to 10.

He calls it the "*definitive guide*", gives an overview of the contents, and finally closes with "*There is much to like about GinA. Mr. König and his co-authors writing is clear and engaging and Manning's layout and typography are up to their usual excellent standards. On it's own, these are good reasons to consider this book if Groovy interests you, but when you mix in the fact that Mr. König is a committer on the Groovy project and has taken an active role in the creation of the language itself, then you have a very compelling reason to choose it.*"

Groovy in Action is an excellent book, written by one of the designers of the Groovy language. If you have any interest in modern scripting languages at all, I would recommend that you check out this book.

Review on german [JavaMagazin](#)

Edition 4.2007 of that print magazine with [Grails as cover story](#) features a [review of Groovy in Action](#) by Grails expert [Sven Haiges](#).

His comments include:

- "ohne Wenn und Aber das Standardwerk zur dynamischen Sprache Groovy"
- "locker geschrieben"
- "krönender Abschluss"
- "Wenn Sie sich mit Groovy beschäftigen, werden Sie um dieses Buch nicht herum kommen!"

Readers of that magazin may also enjoy the recently published [interview with Dierk König \(german\)](#) in the previous edition.

[Groovy tutorial series on Grails podcast](#)

The [Grails podcast](#) by [Sven Haiges](#) starts a brand new [Groovy tutorial](#). In the podcast, Sven Haiges and Dierk König (lead author of [Groovy in Action](#)) discuss Groovy language features and their usage. The series starts with basic datatypes and advances to the dynamic behavior and common usages of Groovy.

Subscribe to this tutorial series and become a Groovy expert!

The code under consideration is embedded in the rss feed and thus visible for iPod users. Others can see it in [snipplr](#). See the [wiki page](#) for details.

enjoy!

Dierk

[More recent voices on Groovy in Action](#)

[Groovy And Others Continue To Expand The JVM Horizon](#)

Jeff Brown: Jeffs Mostly Java Web Log, January 20, 2007

"Manning has recently published [Groovy In Action](#), known as GINA. GINA is being referred to as "**Groovy's Pick Axe Book**" (a reference to Dave Thomas' definitive guide to Ruby, *Programming Ruby*). That is not because GINA was the first major book published on Groovy. This has more to do with GINA's clear, direct and thorough coverage of the language."

[Gettin' Groovy With It](#)

Mark, 2007-02-10

"I picked up Groovy in Action. I highly recommend it. It's very accessible, has lots and lots of code examples, and is highly readable."

[Code for fun](#)

2007-01-10

"I got my copy of Groovy in Action a couple of days ago and ever since I've been reading and trying to apply everything I've learned. [...] I read over the Groovy XML chapter and got really excited. I was like, *#Wow! I bet I could write a five or ten liner groovy script to split up this big ol# XSL doc!# Big ol# fat chance!*"

[Book reception: voices on Groovy in Action](#)

Andrew Binstock in SD Times, [Feeling Groovy at Last](#)

"The definitive book on the language is Manning Press# excellent #Groovy in Action,# which was written by several project leads."

Weiqi Gao, [I Picked It Up, I Can't Put It Down!](#)

"All-in-all, I think Groovy in Action is among the top five Manning books. For me personally, it's also a perception changing and influential book. [...]"

I highly recommend Groovy in Action for Java developers who want to learn Groovy in a systematic way and who are starting Groovy projects."

[Listen to the Groovy in Action authors at JavaPosse](#)

The [JavaPosse](#) podcasters interviewed the Groovy in Action authors Jon Skeet and Dr. Paul King. Check out the podcast and the show notes under [the Groovy in Action JavaPosse interview](#) !

enjoy

Dierk

[Win a free copy of Groovy in Action at the release party contest!](#)

This year started with two important events: the availability of the Groovy in Action book and the final release of Groovy 1.0. Both events will be celebrated with a global release party on January 29th. The idea is to have numerous parties with Groovy enthusiasts all over the planet: Paris, London, Berlin, Munich, Jamaica, Uruguay, and so on. Make sure to find [the party near you](#).

Pictures of this event will be uploaded to [flickr with groovyparty tag](#).

Now the best part. Manning promotes this event with running the following contest:

Send Manning your Groovy photos from Global Groovy 1.0 day and win!

Download a cover image of Groovy in Action at www.manning.com, print it out and take it to your party on January 29th.

Photo must show our poster, clearly indicate the location of the party, and have at least 2 people in the photo.

Any person who sends in a photo that fulfills the easy requirements will receive a **40% off coupon** good for any Manning title (good for up to \$100 purchase).

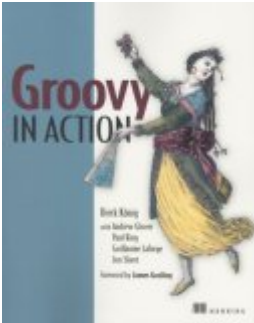

The **top 5 photos** (based on some Groovy theme) will get a **free Groovy in Action** print edition.

Photos must be sent as .jpg files to [mkt \[at\] manning \[dot\] com](mailto:mkt@manning.com). One entry per contestant, one prize per entry. Names and emails must be included with photo submission. Entries must be received by February 5, 2007.

Questions: Visit Manning and look for the Global Groovy 1.0 banner in the right hand column.

So, everybody: don't hesitate to invite your friends organize your party!

Dierk

Programming Groovy

- [Authors' book page](#)
- [Amazon](#)



Groovy Series

This page last changed on Aug 11, 2007 by [hansamann](#).

The Groovy Series is an audio lecture on Groovy and is part of the Grails Podcast. The episodes are produced by Dierk König (Lead author of the book [Groovy in Action](#)) and [Sven Haiges](#). You will find complementary information about the topics below in Dierk's Book and we mention the page numbers at the beginning of each series to help you find the right chapters.

Code Examples at [snipplr.com](#)

The code examples that we discuss in the podcasts are posted to [snipplr.com](#), you can [find all code snippets here](#). Please note that we cannot change the code snippets once they are published (we would run into problems with mentioned line numbers in the podcast), but you are invited to post comments. Simply log in to snipplr and leave us some feedback.

Current Groovy Series Planning

This is a rough plan and we might switch topics, add or delete at any time. The Groovy Series Episodes will be part of the [Grails Podcast](#) and published between regular episodes. You can subscribe to the [podcast feed](#) via: <http://hansamann.podspot.de/rss>. Once the podcast episodes are released, you can click the title links to download the mp3 files manually, too.

1. Strings & GStrings ([direct mp3](#))
 - a. Snippet 1/2: <http://snipplr.com/view/2047/groovy-series-string--gstring-12/>
 - b. Snippet 2/2: <http://snipplr.com/view/2089/groovy-series-string--gstring-22/>
2. Regular Expressions ([direct mp3](#))
 - a. Snippet 1/3: <http://snipplr.com/view/2090/groovy-series-regular-expressions-13/>
 - b. Snippet 2/3: <http://snipplr.com/view/2091/groovy-series-regular-expressions-23/>
 - c. Snippet 3/3: <http://snipplr.com/view/2092/groovy-series-regular-expressions-33/>
3. Numbers ([direct mp3](#))
 - a. Snippet 1/1: <http://snipplr.com/view/2093/groovy-series-numbers/>
4. Ranges ([direct mp3](#))
 - a. Snippet 1/1: <http://snipplr.com/view/2197/groovy-series-ranges/>
5. Lists ([direct mp3](#))
 - a. Snippet 1/1: <http://snipplr.com/view/2198/groovy-series-lists/>
6. Maps ([direct mp3](#))
 - a. Snippet 1/1: <http://snipplr.com/view/2199/groovy-series-maps/>
7. Background on Groovy Typing ([direct mp3](#)) (no code for this part)
8. Groovy Control Structures ([direct mp3](#))
 - a. Snippet 1/2: <http://snipplr.com/view/2498/groovy-series-groovy-control-structuresgroovy-truth/>
 - b. Snippet 2/2: <http://snipplr.com/view/2499/groovy-series-groovy-control-structures/>
9. Closures ([direct mp3](#))
 - a. Snippet 1/1: <http://snipplr.com/view/2866/groovy-series-closures/>
10. GroovyBeans (incl. Expando) ([direct mp3](#))
 - a. Snippet 1/1: <http://snipplr.com/view/2945/groovy-series-groovybeans--expando/>
11. GPath & Co
12. MOP
13. Builders
14. GDK - Working with Objects, Files & I/O, Threads and Processes)
15. Java Integration
16. DB Programming with Groovy
17. XML (Standalone & "Distributed" - eg- RSS, ATOM, REST)

PLEAC Examples

This page last changed on Apr 28, 2007 by [paulk_asert](#).

[PLEAC](#) presents a suite of common programming problems from the [Perl Cookbook](#) in various programming languages. Groovy contains a complete set of examples. Here are links to the these examples:

- Manipulating [Strings](#), [Numbers](#), [Dates](#), [Arrays](#), and [Maps](#)
- [Pattern matching and text substitutions](#)
- [File Access](#)
- [File Contents](#)
- [Directories](#)
- [Subroutines](#)
- [References and Records](#)
- [Packages, Libraries, and Modules](#)
- [Classes and Objects](#)
- [Database Access](#)
- [User Interfaces](#) including screen addressing, menus, and graphical applications
- [Process Management and Communication](#)
- [Sockets](#)
- [Internet Services](#) including mail, news, ftp, and telnet
- [CGI Programming](#)
- [Web Automation](#)

Roadmap, Discussions and Proposals

This page last changed on May 12, 2007 by [paulk_asert](#).

Groovy has an active community from which many ideas and discussions arise. Initial discussions or clarifications occur within the [Mailing Lists](#). Very specific suggestions can often be included in the Groovy [Issue Tracker](#). Ideas which require wider or on-going discussion or greater formalism are documented here.

- *Discussions* are ideas or potential changes in their early formation.
- *Proposals* are ideas that have reached a greater level of maturity but still require discussion or wider communication.
- The *Roadmap* outlines things we have committed to do or hope to do soon.

- [Discussions](#)
 - [Feature Wish List](#)
 - [First impressions](#)
 - [Groovy.Net module discussion](#)
 - [J2ME and Groovy](#)
 - [New Groovy Console Wish List](#)
- [Proposals](#)
 - [Annotation usage with properties](#)
 - [AST Macros and Annotations](#)
 - [C Sharp Groovinator](#)
 - [GJIT - Groovy Just-In-Time Compiler](#)
 - [Grapes and grab\(\)](#)
 - [Groovy realtime archive internet lookup](#)
 - [JSR-295 Binding Builder](#)
 - [Macro Use Cases](#)
 - [MetaClass Redesign \(by blackdrag\)](#)
 - [MetaClass Redesign \(by blackdrag\) part 2](#)
 - [MOP 2.0 ideas](#)
 - [Multiple Assignment Proposal](#)
 - [Multiproject builds](#)
 - [Proposed Website Revamp](#)
- [Roadmap](#)
 - [Not Yet Documented](#)
 - [Gldapwrap - Usage](#)
 - [Sources and tests reorganization and distribution](#)

GEP

Current formal proposals:

[\[GROOVY-1884\] GEP: Adding Bound Properties to GroovyBeans](#)

[\[GROOVY-1709\] GEP: Groovy Enhancement Proposal](#)

[\[GROOVY-158\] Multiple assignment](#)

Discussions

This page last changed on Apr 28, 2007 by [paulk_asert](#).

Current Discussions

- [Feature Wish List](#)
- [First impressions](#)
- [Groovy.Net module discussion](#)
- [J2ME and Groovy](#)
- [New Groovy Console Wish List](#)

Feature Wish List

This page last changed on Dec 10, 2007 by xavier.mehaut@free.fr.

Please use this page to document all the ideas and wishes you'd like to see in Groovy.

- **New function for integers to reverse bits.**
- **Concatenate string with null object.** 'Test'+null will produce 'Test'.
- **Function/Global method 'NVL'. This method avoid null/empty string value of object.** E.g. NVL(null,'Test')='Test' and NVL('','Test')='Test'
- **Joining of list without null elements.**

e.g. [null,'Hello','world',null].join(' ') will produce 'Hello world'

- **Simple and *Robust* way of executing external processes instead of using ProcessBuilder.** Make the convenient string.execute() handle blocked IO streams / threading so users are not required know or understand about ProcessBuilder
- **More Enumerable methods** for lists, arrays and maps (like map, pluck, invoke, ...)
- **Make logical operators (||, &&...) return the value** instead of the boolean equivalent eg.

```
def x = '' || 'test'
assert x == 'test'
```

```
def x = null || 15
assert x == 15
```

- **Make map creation more versatile.** Add constructors that allow creation of a map from 2 collections "HashMap(keys, values)" or a list of entries "HashMap(itemlist)".
- **Make a list and create an auto mapping:**

eg.

```
//Today:
def list = [{"key":"value", 1:1, 2:2, "noAuto":"noAuto"}]
print(list[1]) // will print 1
//Would like to have:
```

```
def autoMapList = [{"key":"value", 1, 2, "auto"}]
print(autoMapList[1]) // will print 1
```

- would like methods to return more than one return value (a la ruby)

```
//Today:
def mytest { return [1,2] }
```

```
c = mytest()
a = c[0]
b = c[1]
```

wanted behavior:

```
def mytest { return 1,2 }
```

```
a,b = mytest()
```

Property reference operator

Groovy 1.0 already has the method reference operator:

```
class X {
def doSomething() { println "hello" }
}
```

```
def obj = new X()

def methRef = obj.&doSomething
methRef()
```

However we do not have anything similar for properties. i.e. we should be able to get a reference to a wrapper object for any object property, and be able to get and set the property via the reference, and get the original property name and owning bean:

```
class X {
def someValue
}

def obj = new X()

def propRef = obj.&someValue // same syntax, but runtime knows it is a property
println propRef.value
propRef.value = 999
println propRef.name // outputs "someValue"
assert propRef.object == obj

// static property equivalent
def propRef = X.&someValue
// Now you need to pass in an instance
propRef.setValue( new X(), 123)
```

This would be useful in Grails and other apps that need the user to specify in their code a reference to another property, for example in GORM declaring the list of "embedded" properties:

class AddressBookEntry

Property access in groovy is not problematic using GPath or subscript operator anyway, so this may not seem so useful. However if we could get some compile-time checking of the validity of the property that would be a nice win. Perhaps combining with the @ operator:

```
class AddressBookEntry {
Address home
Address work
String name

static embedded = [ &@home, &@work ]
}
```

Altho a tad heiroglyphic, this would allow the compiler to ensure that "home" and "work" do exist as declared properties on the class or its ancestors, and hence fail fast.

named parameters everywhere

the proposal is that for functions defined inside groovy or where the debug information is available can be called with the map construct to provide named parameter calling everywhere

```
void helloworld(name, title) {println "hello $title $name"}
can be called as
helloworld( title:"mr.", name:"koen" )
```

this feature would largely improve general readability of code and imho very often enough information should be available to perform the matching (certainly for groovy functions, very often for java binaries with appropriate debug information)

smarter nulls

```
def hello = "hello"
def test = null
```

```
println "$hello$test"
```

should print "hello" iso "hellonull"

variable constraints

Keep dynamic typing while adding real type safety with constraints on variables that all must be true. Though not all these constraints are actually useful they are there for illustrative purposes.

```
percent : as Integer, >= 0, <= 100
total : != 0
...
percent = num/total
```

Embedded XML

The programming language [Scala](#) has built-in support for XML. You can create something like this (taken from the Scala overview document):

```
val labPhoneBook =
<phonebook>
<descr>Phone numbers of<b>XML</b> hackers.</descr>
<entry>
<name>Burak</name>
<phone where="work"> +41 21 693 68 67 </phone>
<phone where="mobile"> +41 78 601 54 36 </phone>
</entry>
</phonebook>;
```

Decoupling of static and instance methods

Also taken from the [Scala](#) programming language. It doesn't have static methods. All the static methods should be placed in a singleton. Static members are not a part of instance variables, so you shouldn't have to declare them in the same class.

New way of declaring Expando

Could be just like in anonymous types in C#. For example:

```
def foo = new (prop:"value")
foo.bar = "bar"
```

First Class Support for User-Defined Boolean Types

There is already quite good support for user-defined numeric data (e.g. classes that act like numeric data in expressions) using the current support for operator overloading. But if one needs to define a class that operates in expressions like a Boolean, it can't be done. The following changes would make this possible and these seem consistent with the overall idea and design of Groovy:

1. Enable operator overloading for logical AND, logical OR, logical NOT. For logical AND and logical OR, the deferred evaluation of the right operand can be maintained by passing a Closure to the method. The signatures might be something like this:

```
Boolean land(Closure)                                Boolean lor(Closure)
```

2. Enable assignment operator overloading. This is needed to allow a semantic like

```
MyBooleanClass bool = true
```

Note that overriding the assignment operator makes it significantly easier to replace numeric types too since one can handle cases like

```
MyNumericClass num = 10
```

which is not possible today.

3. Today due to "Groovy Truth" processing, any non-null object reference (that is not a Boolean) will evaluate to true. To enable user-defined Boolean type data, Groovy Truth would need to be modified to optionally "unbox" a non-null object reference into a Boolean value if it has a `booleanValue()` method. This would allow one to do something like this

```
MyBooleanType bool = something(); if bool || somethingElse() { ... }
```

In such a case, the `bool` instance can be either false or true and can be directly used for control flow and other operations that normally expect a Boolean.

With these changes, user-defined boolean replacement classes would get first-class support in the language.

Smalltalk-like syntax for methods

I've seen that in Groovy 1.5 it was possible to avoid using parenthesis when calling a method. It was made to simplify the reading in a more natural way...

Nevertheless I'm not sure that the goal is today reached... The groovy syntax was primarily settled to make the step from Java easier for java coders... Along the versions, some syntactic sugar was added to fulfill new needs... to reach the point where going from jav to groovy is not so straightforward... Personally it is not an issue, but I would like to point out that if we differ more and more from java, why not adopting a syntax which is more accurate and simpler?

Personally, I find the Smalltalk syntax simpler and more elegant... I think that we could add some syntactic "tournures" of Smalltalk in Groovy 2.0, especially for defining new methods....

definition example :

```
def print: anObject on: aStream {  
  ....  
}
```

or

```
def print: Customer aCustomer on: FileStream aStream {  
  ...  
}
```

or better

```
def print: aCustomer as Customer on: aStream as FileStream {  
  ...  
}
```

use example :

```
def aCustomer = new Customer();  
WriteStream aStream = new FileStream();  
print:aCustomer on: aStream ;
```

First impressions

This page last changed on Jan 09, 2007 by [paulk_asert](#).

Hello. I'm a long-time java (and previously c++) programmer and have used a few scripting languages in the past year or two. I've always wished for a very java-like scripting tool because in my world learning another language syntax/library/etc. just to get something done quickly is impossible. We use java every day, all the time, and write scripts once in a while and (try) to forget about them, so there's really no hope that we'll remember another language.

So when I saw an article in Dr. Dobbs about Groovy I was **very** interested and clicked through to this web site. And I have to say: it's truly awful! The advertisements drown out the content on many pages. The FAQ is nearly useless (one link leads to ads but no content, another to a single question), although the "old FAQ" looks like it *was* useful when the links worked. Browsing around gives the impression that a major focus of this project is a Korean translation. etc. etc.

To me, this web site is very off-putting. If you want busy programmers to consider using this thing you're developing, you really must develop a more confidence-inspiring web presence. I'm sympathetic to what you're trying to do or I would have just clicked away and forgotten you for another year or 2.

Groovy.Net module discussion

This page last changed on May 01, 2007 by [paulk_asert](#).

Further development

Should [Running Groovy on .NET 2.0 using IKVM](#) be a Groovy Module? The intention would be to save people from having to go through the steps mentioned in the link.

It is possible by providing a number of EXE files for invoking Groovy services (groovyc, groovy console, etc.). One important thing is that the process of compiling Groovy files into .NET DLL is a bit tricky. We can compile Groovy files into .classes using **groovyc**, then we have to pack them into a jar file, and finally call **ikvmc** to compile the jar in to a DLL.

J2ME and Groovy

This page last changed on Sep 24, 2006 by [paulk_asert](#).

Just wanted to get couple of opinions on my findings concerning possibility of having Groovy work with J2ME CLDC, which at this moment does not seem likely.

If it is possible, maybe find some possible work around the obstacles.

- Groovy (JVM 1.3) and J2ME (JDK1.4) runs on.

- CLDC uses a KVM. KVM, a smaller version of the Java Virtual Machine (JVM), includes a subset of the standard bytecode verification. Groovy requires and runs on the JVM.

- CLDC does not allow for application-defined classloaders.

Any input would be great! Thanks.

New Groovy Console Wish List

This page last changed on Jan 31, 2008 by [shemnon](#).

This page is dedicated to the discussion of what the Groovy Shell (aka. `groovysh`) and Groovy Console (aka. `groovyConsole`) should be able to do in the future. So please go on and add suggestions.

Wishlist for the command-line Groovy Shell (aka. `groovysh`)

- keep imports (**DONE** see `import` and `show imports` commands)
- remove the requirement for the "go" command (**DONE**)
 - proposal: read lines until one is entered WITHOUT a trailing semicolon or as long as there are open parentheses; change prompt for continuation lines
- the value of last expression evaluated is made available in a variable. The name of the variable is short, e.g. "res". It is also automatically printed to the console (including type?). (**DONE** The last result is saved as the `{_}` variable)
 - alternate name: `"_"` or `"_r"`

from Dierk

- code completion for known methods, DGM, and symbols used so far
- dump transcript to file (**DONE** see `record`).
- nice to have: dump classes and methods that were previously defined (**DONE** See `show classes` and `show variables`, methods are wrapped in a closure and bound to variables)
- nice to have: run code in new jdb console

from Guillaume

- all the above, and...
- possibility to discard imports (since we can keep imports, let's flush them too) (**DONE** See `purge imports`).
- Crazy idea: I'm wondering whether we could leverage ANSI colours in the shell so that we can have some text in colours (perhaps even syntax highlighting???) (**DONE** sans syntax highlighting right now)

from Jürgen:

- learn from Python and especially IPython (`sys.displayhook` etc.) (**DONE** There is a `errorHook` and `resultHook` now).
- (GNU) readline support (**DONE** current trunk uses `jline` for rich buffer editing and history).

additionally: enhance ObjectBrowser to execute selected methods and change the "object under inspection" to the result of that method call. Keep an expression of how to get to that object (e.g. `GPath`). Let ObjectBrowser return this expression and make `groovysh` and `groovyConsole` aware of it such that `groovysh` user can use the `inspect` command to interactively construct such expressions.

Wishlist for the Swing Console (aka. `groovyConsole`)

- basic syntax highlighting in source code (**DONE** in 1.5*)*
- line numbers (be able to turn on / off)
- be able to specify some `.jar` files that will be included into the classpath (**DONE** in 1.6)
- enable standard-de-facto `ctrl+z` for undo and `ctrl+y` for redo
- tabs
- code formatting

Debug features:

- step-by-step execution of statements
- improve variables insight for clarity

Proposals

This page last changed on Jan 04, 2008 by shemnon.

All Proposals

- [Annotation usage with properties](#)
- [AST Macros and Annotations](#)
- [C Sharp Groovinator](#)
- [GJIT - Groovy Just-In-Time Compiler](#)
- [Grapes and grab\(\)](#)
- [Groovy realtime archive internet lookup](#)
- [JSR-295 Binding Builder](#)
- [Macro Use Cases](#)
- [MetaClass Redesign \(by blackdrag\)](#)
- [MetaClass Redesign \(by blackdrag\) part 2](#)
- [MOP 2.0 ideas](#)
- [Multiple Assignment Proposal](#)
- [Multiproject builds](#)
- [Proposed Website Revamp](#)

Proposals By State

Draft

 [Grapes and grab\(\)](#)

Accepted

No content found for label(s) gep-accepted.

Withdrawn

No content found for label(s) gep-withdrawn.

Proposals By Groovy Version

Groovy 1.6

No content found for label(s) gep-v1-6.

Groovy 1.7

 [Grapes and grab\(\)](#)

Groovy 2.0

No content found for label(s) gep-v2-0.

Annotation usage with properties

This page last changed on Jun 01, 2007 by paulk_asert.

Background

Groovy's property mechanism provides a short-hand which simplifies defining typical *JavaBean-style* classes. You simply define the property with no explicit visibility and it is replaced at the bytecode level by a private backing variable, a public setter and a public getter. To the Java world, all three parts are visible. In the Groovy world, conceptually it is OK to just think about the property - Groovy's property notation comes in to play so that using the setter or getter looks like using the property as if it was a field.

This works well but introduces a slight complication with annotations. When using the non-property approach, there are three places in the source code where an annotation may be added (the field, the setter and the getter). With the property approach (idiomatic Groovy) there is just one place available in the source to place an annotation.

Current Behaviour

Currently if an annotation is applied to a property, the compiler will attempt to apply the annotation to the field, the setter and the getter. If any of these fails (e.g. some annotations may apply only to methods or only to fields) the code won't compile.

PROPOSAL: Smarter annotation assignment

Use the `java.lang.annotation.Target` of any annotations to determine where the annotation will be included in the final class.

If the `@Target` of the used annotation marks the annotation as usable only on `FIELD` level, then the annotation will be attached to the generated field.

If the `@Target` of the used annotation marks the annotation as usable on `METHOD` level, then the annotation will be attached to the generated getter and setter.

If the `@Target` of the used annotation marks the annotation as usable on both `FIELD` and `METHOD` level, then the annotation will be attached to all the generated class elements.

Obviously, if multiple annotations are used, there is the possibility of the annotations being split across the generated class elements, e.g. I can use both a field and a method annotation. The field annotation will be attached to the field (and ignored for the getters and setters) while the method annotation will be attached just to the methods.

PROPOSAL: Additional annotation classification mechanism

Sometimes it is desirable to be more selective with annotation than is possible even with smarter annotation assignment, e.g. placing an annotation on just one of the setter or getter. Sometimes an annotation might be possible on both fields and methods but in a particular example we want to apply it to just one. To achieve this we need additional syntax to express how we want to classify an annotation.

One way to do this is to use a synthetic annotation as a prefix to the real annotation. A `@Target` annotation appears in Groovy code at the source level, but it is only synthetic. It has no real definition. It will be like a compiler flag only, and completely ignored in the output.

The `@Target` annotation allows the user to further refine where the compiler should attach an annotation. After it has been used by the compiler, it is completely discarded. The Groovy `@Target` annotation will further specify if an annotation will be attached to a `FIELD`, `GETTER` or `SETTER`, but will never contradict the Java `@Target` annotation. In case such a contradiction occurs the Groovy compiler must emit an error.

Last, but not least I should mention that there will be no naming conflict between the Java `java.lang.annotation.Target` annotation and the Groovy `Target` annotation (probably `groovy.lang.annotation.Target`), because they will be living in completely different context.

An example:

```
@Target([FIELD]) @AutoPopulate(defaultValue="bar")
@Target([GETTER]) @ManagedAttribute(currencyTimeLimit=15)
@Target([SETTER]) @ManagedAttribute(persistPolicy="OnUpdate")
int base = 10
```

As an alternative, we could come up with some other syntax to achieve the same result, e.g. here might be some other ways to write the above:

```
@[FIELD]AutoPopulate(defaultValue="bar")
@[GETTER]ManagedAttribute(currencyTimeLimit=15)
@[SETTER]ManagedAttribute(persistPolicy="OnUpdate")
int base = 10
```

Or this:

```
@AutoPopulate[FIELD](defaultValue="bar")
@ManagedAttribute[GETTER](currencyTimeLimit=15)
@ManagedAttribute[SETTER](persistPolicy="OnUpdate")
int base = 10
```

Or this (using a synthetic annotation parameter):

```
@AutoPopulate(groovyTarget='field', defaultValue="bar")
@ManagedAttribute(groovyTarget='getter', currencyTimeLimit=15)
@ManagedAttribute(groovyTarget='setter', persistPolicy="OnUpdate")
int base = 10
```

AST Macros and Annotations

This page last changed on May 21, 2007 by [shemnon](#).



Work In Progress

Please post your comments on the Groovy developer list!

Introduction

This text here is based on ideas from Jochen Theodorou (see [chitchat-with-groovy-compiler](#) and [ast-macros-and-mixins](#))

Right now, there is no good macro preprocessor for Java. Annotations somehow come close but they don't really fit the bill. In the Java VM, annotations are a runtime feature. You cannot enhance an existing class; only create new ones. This means that you cannot add setters and getters to a class.

When you look at OR Mappers, they even do this at runtime, so there is no way to see what is actually happening: When the error happens, the code which is executed can be completely different than what you see in the source. Even decompiling the class file will not help anymore because the information isn't there, yet. It's only added when the classloader reads the file.

So from a certain point of view, Sun's solution is the worst of all worlds: Your code is changed at a point in time when you can't see it anymore and you cannot move the modification in the compile cycle because the API simple doesn't allow it.

The Goal

To know where you want to go, you must have a goal. The goal here is to reduce the amount of code to write for a certain feature. Specifically, the idea is to be able to move common, repeated code into a single place and be able to reference it easily.

The code must be more flexible than a method call and easier to manage than cut&paste.

Example 1: Bound Properties

A bound property in a Java bean is a field which sends notifications to listeners when it is changed. This means it is made up of these parts:

- There is a list of listeners who are interested in changes
- The field itself
- Methods to add and remove listeners
- Setter code which changes the value and notifies the listeners if the value has changed

Example 2: Merge Java and SQL

OR Mappers will only get you so far. While they will solve many or all problems, they also introduce new ones:

- You have to learn to use the mapper
- You must still understand how a database works
- The mapper will try to connect the Java semantics to the Database semantics. This is not always straightforward. For example, a table might define a non-unique primary key. There is no way to map this to a Java map where primary keys must be unique or you will overwrite objects.
- When a mapper doesn't support a specific corner case, you're in trouble. Mappers are often quite monolithic and they shove their tendrils in many places. Usually, you can't split it apart, injecting your own code in certain places.

So what do we expect from AST Macros in this case?

- They shouldn't get in the way of the developer. If she chooses to use an OR Mapper, she should be free to do so.
- It should help to manage all the cases which the OR Mapper doesn't handle well.
- It should give aid to interface the Groovy code with the OR Mapper.
- It should allow to write code which directly interfaces the DB (for example, when you have to execute some special SQL which the OR Mapper simply can't do).

Some simple examples:

- counting rows
- loading objects from a DB

Examples

Before we look at solutions, let's look at what the code ought to do in the end.

Example 1: Bound Properties

```
class A {
  @BoundProperty int x
}
```

should become

```
import javax.beans.*;

class A {
  // the following is added only once per class
  PropertyChangeSupport propertyChangeSupport

  void addPropertyChangeListener(PropertyChangeListener listener) {
    propertyChangeSupport.addPropertyChangeListener(listener)
  }

  void addPropertyChangeListener(String property, PropertyChangeListener listener) {
    propertyChangeSupport.addPropertyChangeListener(property, listener)
  }

  void removePropertyChangeListener(PropertyChangeListener listener) {
    propertyChangeSupport.removePropertyChangeListener(listener)
  }

  void removePropertyChangeListener(String property, PropertyChangeListener listener) {
    propertyChangeSupport.removePropertyChangeListener(property, listener)
  }

  PropertyChangeSupport[] getPropertyChangeListeners() {
    return propertyChangeSupport.getPropertyChangeListeners
  }

  // the following is added per each annotated property
  private int x

  void setX (int x) {
    propertyChangeSupport.firePropertyChanged('x', this.x, this.x = x)
  }

  int getX() {
    return x;
  }
}
```

specifically:

- When using code completion, the additional fields and methods should be visible.
- The added code should be lean and fast
- ~~It should not get in the way of existing user code, for example, it should be possible to define a custom setter which gets wrapped by the code above~~
- ~~If a custom setter exists, it should be possible to invoke it before the comparison (so you can define setters which convert the value before assigning it)~~

This leads to a couple of demands which an AST Macro Processor (AMP) must met:

- It must be able to see all fields and methods, no matter if the user supplied them or an AMP added them.
- It must be able to add new methods and fields and static code to an existing class and presumably also to classes created by an AMP
- It must be able to reorder source code or at least AST Nodes.

In a perfect world, an AMP should be able to modify the code on a source level and pass it back to an IDE, for example, so that I can see (and debug) what is actually compiled (instead of only seeing the Annotation).

Example 2: Merge Java and SQL

SQL enhanced code is pretty similar to bound properties but more code is generated. The first step is to define the class which maps a database table to a Java object:

```
@Entity
class Foo
{
  @Id
  @Column (type:java.sql.Types.INTEGER)
  int id
  @Column (type:java.sql.Types.CHAR, size:20)
  String name
}
```

After this is compiled, I want to see a special field "SQL" which I can use to build database queries like so:

```
def columns = [Foo.SQL.value, Foo.SQL.name]
def cond = Sql.WHERE () { Foo.SQL.id >= 5 && Foo.SQL.name != null }
def list = Sql.SELECT (columns, table:Foo.SQL.TABLE, where:cond, class:Foo.class)
```

This gets converted by the compiler into:

```
def list = []
def _sql = "SELECT id, name FROM foo WHERE id >= ? AND name IS NOT NULL"
_sql = Sql.eachRow (_sql, [5]) {
  Foo o = new Foo ()
  o.id = it[0]
  o.name = it[1]
  list << o
}
```

The SQL object in Foo also gives access to the standard DAO methods like loading an object by its primary key:

```
def foo = Foo.SQL.load (5)
```

In addition to the simple bound property example, the AMP must also be able to note the usage of an annotated object, so it can convert the Groovy code into SQL at compile time (and possibly check it for mistakes).

Open Issues

Java 1.4/5

Groovy 1.x must run on Java 1.4. We must decide what to do with non-macro annotations, whether we want to support a switch to generate Java 5 classfiles (so Groovy can generate code for third party APTs like Hibernate)

It seems that it is possible to write annotations into Java 1.4 classfiles (see [Commons Attributes](#)). But the question is: Is this futile? There are only a few tools which support annotations **and** Java 1.4.

In this light, it makes more sense to add a switch to allow Groovy to write Java 5 classfiles, so users stuck to 1.4 can still use it and Java 5 users can upgrade when they want to.

Expand or Pass On

The compiler needs a way to decide what to do with an official Java 5 annotation like `javax.persistence.Entity` which is defined in EJB3: Expand it as a macro or pass it on into the class file so a third party library/tool can process it later.

Here, the user might want to decide differently per class (i.e. handle most of these cases with Hibernate and some corner cases with her own AST macro).

For Groovy-specific macros, the solution is to add a marker interface to the macro annotation.

Options

- Add a config file to the compiler
- Users have to use a different annotation which implements both Groovy's marker interface and `javax.persistence.Entity`

Links

- [Java 6 Annotations](#)
- [Getting Started With APT \(Java 6\)](#)
- [Annotation processing in Core Java \(7th Edition\)](#)
- [OOPSLA paper on which Annotations are based](#)

C Sharp Groovinator

This page last changed on Sep 24, 2006 by [paulk_asert](#).

One aspect of Groovy (and Ruby, Python , etc) I really like is the combination of closures and support for them in the Groovy DK .

As an example, consider iterating through every line in a text file :

Groovy

```
file = new File("c:/dynamic.ini");
file.eachLine{
println(it)
}
```

Very elegant and easy on the old eyes.

Java

```
BufferedReader input = null;
try {
input = new BufferedReader (new FileReader("c:/dynamic.ini"));
String line;
while ((line = input.readLine()) != null) {
System.out.println(line);
}
} finally {
if(input != null){
input.close();
}
}
```

Oh dear.

Java with some help

```
Iteration.eachLine("c:/dynamic.ini", new LineHandler() {
public void handleLine(String line) {
System.out.println(line);
}
});
```

and the supporting code :

```
public static void eachLine(String path, LineHandler handler) throws IOException {
FileReader file = null;
try {
file = new FileReader(path); // Open the file.
BufferedReader input = new BufferedReader(file);
String line;
while ((line = input.readLine()) != null) {
handler.handleLine(line);
}
} finally {
if (file != null) {
file.close();
}
}
}
```

C#

Apologies for my C#, I have not been writing it for very long...

```
string line;
using (StreamReader reader = File.OpenText(@"c:\dynamic.ini")) {
while((line = reader.ReadLine()) != null){
Console.WriteLine(line);
}
}
```

No need to escape path string is nice

C# 2.0 with some help

With C# 2.0 and the 2.0 .NET framework the addition of anonymous delegates we can produce a very concise and readable solution

```
Iterators.EachLine(@"c:\dynamic.ini", delegate(string it) {
Console.WriteLine(it);
});
```

similar in elegance to the Groovy one.

This depends on the following utility class

```
public static class Iterators {

public delegate void Closure<T>(T it);

public static void EachLine(string path, Closure<string> closure) {
string line = null;
using (StreamReader reader = File.OpenText(path)) {
line = reader.ReadLine();
while (line != null) {
closure(line);
line = reader.ReadLine();
}
}
}
}
```

Groovinating C#

You will notice that I have started implementing the Groovy DK set of collection iterators (each, findAll, find , etc) for C# 2.0.

I do wish Microsoft and Sun would have built this kind of simplicity in....

There are 2 possible approaches to the Collections :

1. Subclass and add the grooviness
2. Add the grooviness as a set of static methods you pass the collection to

Here is some preliminary code and tests of both types.

This subclasses List<T> and adds the groovination, and offers the same support in a static class

C# 2.0 Code

```
#region Using directives

using System;
using System.Collections.Generic;
```

```

using System.IO;

#endregion

namespace Groovinator {

#region Delegates
public class Delegates {
public delegate void Closure<T>(T it);
public delegate T Functor<T>(T it);
public delegate bool Predicate<T>(T it);
}

#endregion
#region Collection Iterators

public class List<T> : System.Collections.Generic.List<T> {
public void Each(Delegates.Closure<T> closure) {
foreach (T it in this) {
closure(it);
}
}

public List<T> FindAll(Delegates.Predicate<T> predicate) {
//this is a bit poor
List<T> result = new List<T>();
foreach (T it in this) {
if (predicate(it)) {
result.Add(it);
}
}
return result;
}

public T Find(Delegates.Predicate<T> predicate) {
foreach (T it in this) {
if (predicate(it)) {
return it;
}
}
return default(T);
}

public void Map(Delegates.Functor<T> functor) {
List<T> result = new List<T>();
for(int i = 0;i< this.Count;++i){
this[i] = functor(this[i]);
}
}

public static class Iterators {

// Collections
public static void Each<T>(IEnumerable<T> enumerable, Delegates.Closure<T> closure) {
foreach (T it in enumerable) {
closure(it);
}
}

public static List<T> FindAll<T>(IEnumerable<T> enumerable, Delegates.Predicate<T> predicate) {
//this is a bit poor
List<T> result = new List<T>();
foreach (T it in enumerable) {
if (predicate(it)) {

```

```

result.Add(it);
}
}
return result;
}

public static T Find<T>(IEnumerable<T> enumerable, Delegates.Predicate<T> predicate) {
foreach (T it in enumerable) {
if (predicate(it)) {
return it;
}
}
return default(T);
}

public static List<T> Map<T>(IEnumerable<T> enumerable, Delegates.Func<T> functor) {
List<T> result = new List<T>();
foreach (T it in enumerable) {
result.Add(functor(it));
}

return result;
}

}

#endregion
#region File Iterators
public static class IOIterators{
// File related iterators
public static void EachLine(string path, Delegates.Closure<string> closure) {
string line = null;
using (StreamReader reader = File.OpenText(path)) {
line = reader.ReadLine();
while (line != null) {
closure(line);
line = reader.ReadLine();
}
}
}
}
#endregion
}

```

Some Usage Examples

```

// open, print all lines of a text file , close
IOIterators.EachLine(@"c:\dynamic.ini", delegate(string it) {
Console.WriteLine(it);
});

List<string> list = new List<string>();

// populate list

// print a list of string
list.Each(delegate(string it) {
Console.WriteLine(it);
});

System.Collections.Generic.IEnumerable<string> res;

// find all items matching the predicate item.Contains("8")

```

```
res = list.FindAll(delegate(string it) {
return it.Contains("8");
});

// find the first item where Item.Equals("10")
string ten = list.Find(delegate(string it) {
return it.Equals("10");
});

List<int> nums = new List<int>();
for (int j = 1; j < 11; ++j) {
nums.Add(j);
}

// apply a functor ( multiply by 2 ) to a list of ints
nums.Map(delegate(int num) {
return num * 2;
});
```

GJIT - Groovy Just-In-Time Compiler

This page last changed on Sep 14, 2007 by chanwit@gmail.com.

Background

Groovy has a performance problem, compared with Java, due to its dynamic nature, while there are several requests for performance improvement.

Proposed Solution

Implementing just-in-time compiler is a proper way to help boosting performance of Groovy. It would be great to have a Groovy module (in this case a JVMTI agent) to help re-compiling Groovy classes during runtime.

Implementation

GJIT could be thought as a hotspot compiler for Groovy. There are two main components.

The first one is a JVMTI agent to profile calls to `ScriptBytecodeAdapter.invoke*` at the caller sites. The profiler then gathers information, including Type information, from `MetaClassImpl.getMethod*` to identify hot regions, with a threshold value.

After the threshold is reached the profiler tell the optimiser thread, the second component, to perform dataflow analysis on these hot regions, by replacing calls to `ScriptBytecodeAdapter.invoke` with direct calls (to bypass the meta-layer). Classes then re-compiled and re-defined using the JVMTI instrumentation. (no new class created, so PermGen not affected)

There's also a hook to detect the change of meta-class of each class. If there's a change, the optimiser will re-store the original class and start profiling it again.

This is an experimental release. GJIT 0.3 is in its alpha-stage, and not yet ready for production use. The binary is available here: [git-all-0.3.jar](#)
The early version of GJIT is located at <http://svn.codehaus.org/grails-plugins/grails-aop/trunk/MAIN/agent/>

Usage

Add

```
-javaagent:gjit-all-0.3.jar
```

to your Java command line to use GJIT.

Known Bugs

- ~~GJIT's optimiser thread will not stop by itself. You have to kill the process manually.~~

Grapes and grab()

This page last changed on Feb 26, 2008 by [shemnon](#).

Abstract

Grape (The Groovy Adaptable Packaging Engine or Groovy Advanced Packaging Engine) is the infrastructure enabling the `grab()` calls in Groovy, a set of classes leveraging [Ivy](#) to allow for a repository driven module system for Groovy. This allows a developer to write a script with an essentially arbitrary library requirement, and ship just the script. Grape will, at runtime, download as needed and link the named libraries and all dependencies forming a transitive closure when the script is run from existing repositories such as Ibiblio, Codehaus, and java.net.

TimeFrame

The prototype is ready for inclusion into the trunk immediately, however the principal dependent library used ([Apache Ivy](#)) is a SVN snapshot. We should at least wait for a Beta 2 release and preferably for an RC release of the library before merging into trunk. That makes it a possible 1.6 candidate, and more likely a 1.7 candidate.

General Requirements

- There must be a means to cause all calls to the Grape system to become no-ops and rely strictly on the JVM classpath.
- Grape should support bringing in packages from Maven 2 repositories.
- There should be some notion of 'endorsed modules' that are shortcutted in for easier use. For example: Scriptom, GroovyWS, SwingXBuilder. These can be hosted as regular Maven2 POMS or some other repository mechanism can be used.
- There should be command line tools similar to RubyGems, to add, remove, enumerate, and update versions of Grapes stored in the local cache.
- The implementation should not prevent movement into a container style module system such as integrating OSGi or Java 7 Super Packages. (this requirement should not be construed as an endorsement of either)

Specification

Module versioning model.

Grape follows the Ivy conventions for module version identification, with naming change.

- `group` - Which module group the module comes from. Translates directly to a Maven groupId or an Ivy Organization. Any group matching `/groovy[x][\..*]^/` is reserved and may have special meaning to the groovy endorsed modules.
- `module` - The name of the module to load. Translated directly to a Maven artifactId or an Ivy artifact.
- `version` - The version of the module to use. Either a literal version ('1.1-RC3') or an Ivy Range ('2.2.1,' meaning 2.2.1 or any greater version).

Code Level Support

Annotation

One or more `groovy.lang.Grab` annotations can be added at any place that annotations are accepted to tell the compiler that this code relies on the specific library. This will have the effect of adding the library to the classloader of the groovy compiler. This annotation is detected and evaluated before any other resolution of classes in the script, so imported classes can be properly resolved by a `@Grab` annotation.

```

import com.jidesoft.swing.JideSplitButton
@Grab(group='com.jidesoft', module='jide-oss', version='[2.2.1,)'')
public class TestClassAnnotation {
public static String testMethod () {
return JideSplitButton.class.name
}
}
}

```

An appropriate `grab(...)` call will be added to the static initializer of the class of the containing class (or script class in the case of an annotated script element).

TODO: How do we add a grab annotation to straight scripts? The current workaround is to annotate something in the script that can accept an annotation, like a method or parameter.

Method call

Typically a call to `grab` will occur early in the script or in class initialization. This is to insure that the libraries are made available to the `ClassLoader` before the groovy code relies on the code. A couple of typical calls may appear as follows:

```

// random maven library
grab(group:'org.jidesoft', module:'jide-oss', version:'[2.2.0,)'')
grab([group:'org.apache.ivy', module:'ivy', version:'2.0.0-beta1', conf:['default', 'optional']],
[group:'org.apache.ant', module:'ant', version:'1.7.0'])

// endorsed Groovy Module
// FUTURE grab('Scriptom')

```

- ~~`grab(Object self, String module)`~~, `grab(Object self, Map attrs)`, and `grab(Object self, Map attrs, Map... dependencies)` will be added to the DGM so that references to the backing Grape classes will not be needed. These will be proxies to the main Grape class calls.
- Multiple calls to `grab` in the same context with the same parameters should be idempotent. However, if the same code is called with a different `ClassLoader` context then resolution may be re-run.
- `grab` is disabled by default. Starting calling `Grape.initGrape()` will enable `grab`. Any calls to `grab` before `initGrape()` is called will be ignored. Hence Grape managed classloading is opt in only.
- If the `args` map passed into the `grab` call has an attribute `noExceptions` that evaluates true no exceptions will be thrown.
- `grab` requires that a `RootLoader` or `GroovyClassLoader` be specified or be in the `ClassLoader` chain of the calling class. By default failure to have such a `ClassLoader` available will result in module resolution and an exception being thrown (if `initGrape()` has been called).
 - The `ClassLoader` passed in via the `classLoader:` argument and it's parent classloaders.
 - The `ClassLoader` of the object passed in as the `referenceObject:` argument, and it's parent classloaders.
 - The `ClassLoader` of the class issuing the call to `grab`
- `-grab(String)` is a shortcut for endorsed groovy modules and will be equivalent to `grab(group:'groovy.endorsed', module:<the module>, version:<the version of groovy being run>)-`

TODO: all discussion of `grab(String)` are purely hypothetical as it hasn't been prototyped or the needed infrastructure set up

`grab(HashMap)` Parameters

- `group:` - `<String>` - Which module group the module comes from. Translates directly to a Maven `groupId`. Any group matching `/groovy(\..!x|x\..)/` is reserved and may have special meaning to the groovy endorsed modules.
- `module:` - `<String>` - The name of the module to load. Translated directly to a Maven `artifactId`.
- `version:` - `<String>` and possibly `<Range>` - The version of the module to use. Either a literal version ('1.1-RC3') or an Ivy Range ('2.2.1,' meaning 2.2.1 or any grater version).
- `conf:` - `<String>`, default 'default' - The configuration or scope of the module to download. The default `conf` is `default`: which maps to the maven `runtime` and `master` scopes.
- `force:` - `<boolean>`, defaults true - Used to indicate that this revision must be used in case of conflicts, independently of
- `conflicts manager`

- `changing`: - <boolean>, default false - Whether the artifact can change without it's version designation changing.
- `transitive`: - <boolean>, default true - Whether to resolve other dependencies this module has or not.

There are two principal variants of `grab`, one with a single Map and one with an arguments Map and multiple dependencies map. A call to the single map `grab` is the same as calling `grab` with the same map passed in twice, so `grab` arguments and dependencies can be mixed in the same map, and `grab` can be called as a single method with named parameters.

There are synonyms for these parameters. Submitting more than one is a runtime exception.

- `group`:, `groupId`:, `organisation`:, `organization`:, `org`:
- `module`:, `artifactId`:, `artifact`:
- `version`:, `revision`:, `rev`:
- `conf`:, `scope`:, `{{configuration}}`}

Grape may want support simple ranges ('2.2.1..'*') or '2.2.1..'<'3.0.0' meaning any version greater than 2.2.1 but no 3.x version. But there are implementation problems, trying either of these ranges creates a runtime error having to do with enumerating the list.

Arguments Map arguments

- `classLoader`: - <GroovyClassLaoder> or <RootClassLoader> - The ClassLoader to add resolved Jars to
- `refObject`: - <Object> - The closest parent ClassLoader for the object's class will be treated as though it were passed in as `classLoader`:
- `validate`: - <boolean>, default false - Should poms or ivy files be validated (true), or should we trust the cache (false).
- `noExceptions`: - <boolean>, default false - If ClassLoader resolution or repository querying fails, should we throw an exception (false) or fail silently (true).

Tool level support

GroovyStarter

`GroovyStarter` has been enhanced with an additional `--grab` option. All three main arguments are required (`group`, `module`, `version`). Resolved jars will be added to the `RootLoader`. These modules will be resolved prior to the main class call.

LoaderConfiguration conf files

`LoaderConfiguration` has been enhanced with an additional 'grab' line option, where the option is followed by all three arguments (`group`, `module`, `version`). Resolved jars will be added as though they were specifically mentioned by a 'load' line option. These lines are similarly subject to property replacement as 'load' lines are.

<groovyc> support

The `GroovyC` ant task has been enhanced with `<grab>` child elements. The attributes `group`, `module`, and `version` specify the module to grab.

TODO: currently this doesn't work when `fork='true'`

File Level View

The downloaded modules will be stored according to Ivy's standard mechanism with a cache root of `~/ .groovy/grape`

Command Line Tools

```
grape install <groupId> <artifactId> [<version>]
```

This installs the specified groovy module or maven artifact. If a version is specified that specific version will be installed, otherwise the most recent version will be used (as if '*' we passed in).

```
grape list
```

Lists locally installed modules (with their full maven name in the case of groovy modules) and versions.

```
grape resolve (<groupId> <artifactId> <version>)+
```

This returns the file locations of the jars representing the artifacts for the specified module(s) and the respective transitive dependencies.

Motivation

The motivation for introducing Grape into groovy is to resolve the library and module proliferation problem we are encountering. As a general purpose language Grape is suitable for a lot of wildly variable tasks. Providing groovy ways to do those things can create 'bloat' because a large number of classes that are

Rational

Credit for coming up with the name Grape goes to Jörg Staudemeyer and grab Andres Almiray.

Use of Maven Repositories

Maven is big, there are tons of Java libraries that are already deployed in a well-known infrastructure. Because almost all  of these are straight Java they are all usable in Groovy out of the box.

Use of Ivy

- Ivy is licensed under the ASL2, which is the same license as Groovy
- Ivy is focused strictly on Repository Management. Maven has a strong Repository Management portion, but also has other aspects not germane to the needs of the Grape system, namely build management and project management. If the goal is to provide a means to drop unneeded code we shouldn't bring in unneeded code.
- Ivy provides for an extensible repository resolution system. If we decide to roll our own Groovy Repository we have the infrastructure to do it, we can also support other non-maven repository systems if needed.

Backward Compatibility

GroovyStarter does do some existing library management, namely loading every single jar in `~/groovy/lib` into the RootLoader. With Grape installed such behavior can continue, and is merely duplicate effort with no adverse implications. In the 2.0 timeframe we may want to look into deprecating or removing the auto-include of the `~/groovy/lib` directory.

Reference Implementaion

[A 0.1.0 protptype is available](#). This shows the `grab(...)` method, the `@Grab` annotation, and command line tools. Examples are available in subversion in [src/examples](#), except for the annotation, where the best examples are in the [test class](#).

This version may conflict with Gant, only one of the Ivy files should exist under `$(GROOVY_HOME)/libs`. If the beta-1 jar is left in place then Grape may not work.

Future Directions

We may want to increase the kind of repositories that Grape can handle from simple Ivy and Maven repositories to other areas such as OSGi Repository Bundles , JNLP (WebStart) files and JSR-277 JAM files.

Groovy realtime archive internet lookup

This page last changed on Sep 24, 2006 by [paulk_asert](#).

What is Grail?

Groovy Realtime Archive Internet Lookup == GRAIL

This "grail" ideas are not related to the [Grails web application framework](#).

What does it do?

Check IRC log below

The idea is to have something like RubyGems or CPAN for Groovy automating the resolution of dependencies on external jars, and downloading them automatically 😊, the end of jar hell.

A list of potential features

- Dynamic class loading without using import statements...
- Maven repository support, with local/mirrors support,
- virtual maven repos (a repository that does not exist, but is presented as such by an index that can point to any jar, i.e. for Sourceforge based files, or other non ibiblio based jars)
- Support for version resolution, scoping
- Jar integrity verification
- the base for doing it: <http://www.pmilne.net/Launcher/>

Going forward

After a chat with Phil Milne, the author of Launcher.java, we could use his code as a base. He is also in! The project could be called Jail (Java Archive Internet Lookup) instead of Grail, because it would be for any java environments, not only Groovy. The license would be a simple MIT style license. Maybe hosted at Codehaus?

Grail Genesis : the Groovy 1.0 Beta 7 [Release Process](#) IRC logs...

08:36 <tug> Jstrachan: can you put the embeddable jar on the ftp download area, once built.
08:37 <jstrachan> happy
08:37 <Guillaume> we should also distribute this artifact as well
08:38 <jstrachan> you mean in the dist.codehaus.org/groovy/jars area?
08:40 <Guillaume> I guess so along the groovy.jar so that ppl can just choose one single jar with everything included
..
08:43 <Guillaume> perhaps a sub-project, like xml-rpc I guess (for the xml-rpc.jar) with reactor?
08:43 <jstrachan> good idea
08:43 <jstrachan> hmm, no the subproject only gets copied into the binary distro not as a separate jar AFAIK
..
08:44 <tug> After build it creates target/embedable/groovy-all-xxx.jar
08:44 <tug> Include that jar file on it's own, in the ftp area, for ease of fetching...
..
08:44 <pombreda> Guillaume: instead of having one big jar, what about something like maven/ibiblio integration? something like RubyGems <http://rubygems.rubyforge.org/wiki/wiki.pl> or CPAN?
08:45 <jstrachan> we've got the repo, maven, we just need to use in a clever way
08:45 <jstrachan> I friend of mine has done a cool class loader to do this... <http://www.pmilne.net/Launcher/>
08:45 <Guillaume> pombreda, the big jar includes the asm jars into one big groovy+asm
08:46 <tug> Jez says: Can we put the bloglines example in the groovy src examples dir..
08:46 <Guillaume> tug-jez, good idea!
..
08:46 <Guillaume> we'd need to add the http-client jar to the dependencies
08:47 <jstrachan> lets do that next release - its been chugging for 30 mins already

...

08:46 <pombreda> Guillaume: but for stuffs like xml-rpc getting based on Maven... integrated in Groovy... would be way cool.

08:48 <jstrachan> it'd be cool to just type : x = new com.foo.something.Whatever()

08:48 <jstrachan> and for it to just work, downloading whatever it needs

08:48 <pombreda> Yehaa! happy)) that would rock!

...

08:48 <Guillaume> what if there are two com.foo.something.Whatever ? with three different releases?

08:49 <jstrachan> you setup rules for versions

08:49 <Guillaume> yeah, nobody reads the reports... useless

08:49 <jstrachan> e.g. use latest production releases or for 'foo' use version '1.2.3' latest production release is fine for most people plus we should include metadata in the manifest of the versions we depend on so dependent jars should match the release of each project

08:51 <Guillaume> and if groovy requires a specific version, but the script you're running would require another one?

08:51 <jstrachan> things could certainly get nasty

08:51 <pombreda> I would rather get a manifest than an ugly xml manifest?

08:51 <jstrachan> but you could do a nice simple

08:52 <jstrachan> versionScope

Unknown macro: { // do something with version 1 of foo }

08:52 <jstrachan> versionScope

Unknown macro: { // do something with version 2 }

08:52 <jstrachan> etc

08:52 <jstrachan> versionScope

Unknown macro: { it.setMinimumRequirement("foo", 2.0); }

08:52 <jstrachan> etc

08:52 <Guillaume> hmmm... with a specific classloader for the scoped stuff?

08:52 <jstrachan> yep

08:52 <Guillaume> in its own thread,

08:53 <jstrachan> threads don't matter, its the classloader that does

08:53 <Guillaume> interesting idea

08:53 <jstrachan> all the Launcher is, above, is a classloader that auto-downloads stuff it needs

08:53 <jstrachan> would be trivial to add to groovy

08:53 <jstrachan> **expecially** for use in IDEs / consoles

08:53 <jstrachan> where you just wanna script something quick

08:53 <jstrachan> and not spend most of the time setting the goddamned classpath

08:54 <jstrachan> I'm sure it'd be easy to make a versionScope() thingy introspectable, so you could enquire the versions your using etc

08:54 <pombreda> and include some auto Md5 verif

...

08:56 <pombreda> jstrachan, Guillaume: this idea rocks... the end of jar hell unhappy(

08:59 <pombreda> what about a name for the version/jar loader? GRAIL

08:59 <pombreda> Groovy Realtime Archive Internet Lookup == GRAIL

08:59 <precipice> ha!

08:59 <Guillaume> pombreda, that sounds like the French verb "grailer" happy

09:00 <jstrachan> happy

09:00 <jstrachan> or just 'groovy' happy

09:00 <pombreda> Guillaume, it would eat jars, would it? "grailer"== eating in slang

09:00 <brianm> WOOT

09:01 <brianm> you talking the go-get-jar-from-maven at runtime thing?

09:01 <jstrachan> yes

09:01 <jstrachan> happy

09:01 <brianm> GRAIL is perfect

09:01 <jstrachan> I'm sold!

09:01 <brianm> heh, better than "go get" use a remote classloader

09:01 <Guillaume> the holy grail cheesy

09:01 <jstrachan> happy

09:01 <Guillaume> who's going to implement taht?

09:01 <brianm> Sun already did

09:01 <Guillaume> wasn't there someone supposed to have been working on it?

09:02 <jstrachan> it shouldn't take long to wire the launcher into the shell / console etc

09:02 <brianm> parsing out maven paths will be tricky =)

09:02 <jstrachan> it does this already

09:02 <brianm> the package -> project mapping is doable though
09:02 <jstrachan> its already done, check the link above
...
09:05 <pombreda> about GRAIL: some issue: ibiblio/maven is so unreliable... it is down every now and then ...
09:06 <jstrachan> mirrors
09:06 <brianm> should check local maven repo first
09:06 <jstrachan> maven supports mirroring of repos, or have your own local mirror of projects you're interest in etc
09:06 <pombreda> good point.
09:08 <pombreda> that could call for a project.groovy rather than a project.xml...
...
09:44 <pombreda> brian: about GRAIL, you said earlier : Sun already did. could you elaborate?
09:44 <brianm> the remote classloader
09:44 <brianm> all we need to do is figure out url for jars
09:44 <jstrachan> the Launcher implementation trawls the maven repo to build up indices AFAIK
09:47 <pombreda> but doesn't remote class loader runs has security constraints?
09:53 <pombreda> briaime: AFAIK: remote class loader can only originate jars from the same code base as the app.
09:53 <pombreda> Check <http://java.sun.com/j2se/1.4.2/docs/guide/extensions/spec.html>
...
19:52 <pombreda>Guillaume: about GRAIL, I will start a page in the Groovy space, and post an edited IRC log. OK?
19:53 <Guillaume>okey dokey
19:53 <Guillaume>you want to work on that?
19:54 <pombreda>yep. why not? we call it GRAIL or Grail?
19:54 <Guillaume>not too many caps 😊
19:54 <Guillaume>you're welcome to work on anything you like 😊
19:54 <pombreda>So? which one?
19:56 <oni> what is GRAIL?
19:58 <pombreda>oni: Groovy Realtime Archive Internet Lookup == GRAIL
19:59 <oni> pombreda and what does it do?
20:00 <pombreda>oni: check today's IRC log at : <http://servlet.uwyn.com/drone/log/hausbot/groovy>
20:00 <pombreda>the idea is to have something like RubyGems or CPAN for Groovy
20:01 <pombreda>automating the resolution of dependencies on external jars 😊, the end of jar hell

JSR-295 Binding Builder

This page last changed on Jan 04, 2008 by [shemnon](#).

This proposal is deferred and not under active development or consideration

The reason for deferral is that the JSR-295 API is too unstable. Since this posting it has gone under a major re-design. It will not be revisited any earlier than the posting of the first proposed final draft for that reason.

Based off of an example in Scott Violet's [last blog](#) at sun, a BindingBuilder in practice would look something like this:

```
// code from elsewhere...
public class Bug {
  @BoundProperty String ID
  @BoundProperty int priority
  @BoundProperty String synopsis
  @BoundProperty String type
}

List<Bug> bugs = [...] // assuming generics make it into 1.1

bugTable = theSwingBuilder.bugTable
summaryLabel = theSwingBuilder.summaryLabel
idTF = theSwingBuilder.idTF
descriptionTF = theSwingBuilder.descriptionTF
typeTF = theSwingBuilder.typeTF
prioritySlider = theSwingBuilder.prioritySlider

// the actual bindings
bindings = new BeansBindingBuilder()
context = bindings.context() {
  binding(source: bugs, target: bugTable, property:'elements') {
    binding(value:'${ID}') {
      tableColumn(0)
    }
    binding(value:'${priority}') {
      tableColumn(1)
    }
    binding(value:'${synopsis}') {
      tableColumn(2)
    }
  }
  binding(
    source:bugTable,
    value:'${bb:listSize(selectedElements)} of ${bb:listSize(elements)} are selected',
    target:summaryLabel,
    property:'text')
  binding(source:bugTable, value:'${selectedElements.ID}', target:idTF, property:'text') {
    textChangeStrategy(CHANGE_ON_TYPE)
    concatenatingCondensor(['', '', ','])
  }
  binding(source:bugTable, value:'${selectedElements.synopsis}', target:descriptionTF,
    property:'text') {
    textChangeStrategy(CHANGE_ON_TYPE)
    concatenatingCondensor(['', '', ','])
  }
  binding(source:bugTable, value:'${selectedElements.type}', target:typeTF, property:'text') {
    textChangeStrategy(CHANGE_ON_TYPE)
    concatenatingCondensor(['', '', ','])
  }
  binding(source:bugTable, value:'${selectedElements.priority}', target:prioritySlider,
    property:'value')
}

context.bind()
```

Once I get a better feel for the existing code I can mock up what all the possible children would be.

Here's what the java snippets from the post are

```
context = new BindingContext();

List<Bug> bugs = ...;
Binding tableBinding = context.addBinding(
bugs,          // Source for the binding, the List of bugs in this case.
null,         // Expression, relative to the source, used in obtaining the property.
// For this example it's null, meaning use bugs as is.
bugTable,    // Target of the binding, a JTable in this case.
"elements"); // The property of the target to bind to.

tableBinding.addBinding(
"${ID}",      // Expression evaluated relative to each Bug.
// In this case, it's treated as bug.getID().
null,        // Target value (I'm not going to get into this parameter now)
TableColumnParameter, 0); // Specifies the binding applies to the first column

tableBinding.addBinding("${priority}", null, TableColumnParameter, 1);
tableBinding.addBinding("${synopsis}", null, TableColumnParameter, 2);

Binding textFieldBinding = context.addBinding(
bugTable,          // Source of the binding, the JTable in this case.
"${selectedElements.ID}", // Expression relative to the source. Evaluates to the
// the id property of each of the selected elements
idTF,              // Target of the binding, a JTextField here.
"text",            // The target property to bind to.
// The next line specifies the 'text' property should change as you type.
// The default is to change the property on enter/focus leaving.
TextChangeStrategyParameter, TextChangeStrategy.CHANGE_ON_TYPE);

textFieldBinding.setListCondenser(ListCondenser.concatenatingCondenser(
"\n", // The string placed before each element
"\n", // The string placed after each element
", "); // The string that separates each element.

context.addBinding(
bugTable, // The source of the binding, the table in this case.
// The expression evaluated relative to the source. Notice this makes use
// of the function "listSize", that returns an size of the list supplied to it.
"${bb:listSize(selectedElements)} of ${bb:listSize(elements)} are selected",
summaryLabel, // The target of the binding, a JLabel here.
"text"); // The target property to bind to

context.bind();
```

Macro Use Cases

This page last changed on Apr 28, 2007 by [paulk_asert](#).

Use this page to list use cases for AST-level macros in Groovy.

How do you want to use such macros? Show examples of their usage (without showing how they're implemented). Add to the bottom of the page.

Increase code readability

Rearrange code portions

The end-weight principle for natural languages says the longer stuff should be at the end of a sentence. In Groovy/Java, while and if statements are usually heavy in the block/statement, and light in the condition.

When the statement/block is short and the condition long, it can be more readable to put the block last. Eg:

```
do{ i++; return c }if(
( severance.taxAmount >= TaxYear2006.taxAmounts.severanceLimit['dependent'] ||
... ..
... ..
)
```

is transformed to:

```
if( ... .. ){ i++; return c }
```

We could use 'unless' and 'until' if using 'if' and 'while' caused problems.

Common modifier

When a long list of methods and/or fields have the same modifier/s, it may be more readable to apply them to a whole block, eg:

```
static{
def a(){ ... }
def b(){ ... }
}
```

becomes

```
static a(){ ... }
static b(){ ... }
```

Transform statements

Eg:

```
def genUniqueScriptName(){ static int i=1; 'Script_' + i++ }
```

becomes

```
class UniqueScriptName{ static int i=1; static gen(){ 'Script_' + i++ }
```

triggered by the 'static' modifier of a field in a function.

Names for operators

Use names instead of symbols for operators, eg:

```
if( a and b )
```

becomes

```
if(a && b)
```

or change their names to something shorter, eg:

```
if( a of A )
```

becomes

```
if( a instanceof A )
```

Equivalence of block and statement

Forgoing curlies for all statements, making a statement and block equivalent always:
Eg:

```
try A.call()  
catch(e) if(e instanceof ABCException) throw new BusinessException()
```

Use other natural languages with Groovy

Enable fuller internationalization of Groovy, eg:

```
mientras( i < 10 ){ ... .. }
```

would convert to

```
while( i < 10 ){ ... .. }
```

if a Spanish option for Groovy was loaded.

More Seamless Integration with Java and Java-like languages

Embed Java code within Groovy without quoting it,
and without needing to bind variables to the same name, ie, no `binding.setVariable('i', i)`.
eg:

```
int i= 0  
java('jdk1.5.0_07'){ System.out.println i; class ... .. }
```

Simplify the Antlr lexer/parser

Many existing syntactic sugars could be re-implemented as macros in a standard macro library.
This might simplify the Antlr lexer/parser, enabling better maintenance of and extensions to it.

Eg, properties where:

```
String reading= 'OK'
```

expands to:

```
private String reading= 'OK'  
public String getReading(){ this.xxxx }  
public void setReading( String s ){ this.xxxx= s }
```

Other examples:

- `for(i in ...)` expanding to code using iterator
- shorthand notation for invoking method with closure/s at last parameter/s

MetaClass Redesign (by blackdrag)

This page last changed on Apr 28, 2007 by [paulk_asert](#).

This page is dedicated to the new Design of the MetaClass.

General Problem

It seems that we need 2 parts for MetaClass, one for the implementation and one for the user to customize the behavior. The reason for this is, that the customization is done by subclassing the implementation part. This means it is impossible to stay in the specification part (classes from groovy.*) to do a all day thing. Additionally the method signatures must be fixed to not to break code.

Current Behavior

Currently we do something like:

```
class MyMetaClass extends MetaClassXY {
public Object invokeMethod(Object o, String name, Object[] args) {
preProcessing();
super.invokeMethod(o, name,args);
postProcessing();
}
}
```

- preProcessing might change the arguments, name or call object, or might just do some logging.
- postProcessing might evaluate the return value of the method call, call additional methods, or just do logging
- every part here might end the invokeMethod method, that means super.invokeMethod might not be called

This is very flexible, it allows interception and logging as well as transformation at the same time.

Basic Design

If we want to separate the two cases (runtime MetaClass, user defined MetaClass) in two classes, then one must call the other. As the user part should stay in the specification, it can't know the exact class of the runtime, or which method to call there. This means the user part must be called from the MetaClass in the runtime. Since we are not able to call "super" then we need an additional Object, that we make the call on:

Call Chain

```
class MyMetaClass extends MetaClassXY {
public Object invokeMethod(Object o, String name, Object[] args, CallChain chain) {
preProcessing();
chain.invoke(o, name,args);
postProcessing() ;
}
}

interface CallChain {
Object invoke(Object base, String name, Object[] args)
}

class RuntimeMetaClass {
...
Object invokeMethod(Object base, String name, Object[] args, ....) {
process(args)
MetaClass mc = getMetaClass()
}
```

```

if (mc!=null) {
return mv.invokeMethod(base,name,args, new CallChain() {
Object invoke(Object base, String name, Object[] args) {
return doRealInvoke(base,name,args...)
}
}
} else {
return doRealInvoke(base,name,args...)
}
}
...
}

```

That's a bit like the continuation passing style.

Disadvantages

- A custom MetaClass results in creating a ChainCall object each time an method of that class is invoked.

Advantages

- The old behavior can be preserved and guranteed

Multiple Behaviors controlled by Class

If we want to split the behavior, then we could have an interface for each of the cases

```

interface MetaClassInterceptor {
// thorws MissingMethodException if no interception is done, which results in normal method
invocation
Object invokeMethod(Object base, String name, Object[] args);
}

interface MetaClassLogger {
// throws never MissingMethodException and does not change the arguments
void invokeMethodEntry(Object base, String name, Object[] args);
void invokeMethodExit(Object base, String name, Object[] args);
}

interface MetaClassTransformer {
// basically the same as above
Object invokeMethod(Object base, String name, Object[] args, CallChain chain);
}

class RuntimeMetaClass {
...
Object invokeMethod(Object base, String name, Object[] args, ....) {
process(args)
MetaClass mc = getMetaClass()
if (mc!=null) {
Object result = null;
MetaClassLogger logger=null
MetaClassInterceptor interceptor=null
MetaClassTransformer transformer=null
if (mc instanceof MetaClassLogger) logger = (MetaClassLogger ) mc
if (mc instanceof MetaClassInterceptor) interceptor = (MetaClassInterceptor) mc
if (mc instanceof MetaClassTransformer ) interceptor = (MetaClassTransformer ) mc
try {
if (logger!=null) logger.invokeMethodEntry(base,name,args)
if (transformer!=null) {
transformer.invokeMethod(base,name,args, new CallChain() {
Object invoke(Object base, String name, Object[] args) {
return invokeWithInterceptor(interceptor, base,name,args...)
}
})
}
}
}
}
}
}

```

```

} else if (interceptor!=null) {
return invokeWithInterceptor(interceptor, base,name,args...)
}
} finally {
if (logger!=null) logger.invokeMethodExit(base,name,args)
}
} else {
return doRealInvoke(base,name,args...)
}
}
...
}

```

Maybe it is a bit overkill, since a transformer can act as interceptor, but a logger is surely more lightweight than a interceptor or transformer.

Disadvantages

- the common case still requires a ChainCall object each time an method of that class is invoked

Advantages

- the logging case does not influence the invokation so much

General Disadvantage

The general disadvantage of the seperation is that we need to associate the custom MetaClass and the runtime MetaClass. Again I see two ways:

1. let the runtime get the custom MetaClass:

```

class RuntimeMetaClass {
Class theClass;
MetaClass getMetaClass() {
return registry.getMetaClass(theClass)
}
...
}

```

A null entry in the registry would then mean, that no custom MetaClass is set, in case of GroovyObject, the logic must be changed a little because null here means just no per instance MetaClass. As there is only one runtime MetaClass and several behaviors this means that it is not possible to do

```
metaClass.getProperties()
```

or something alike. Again we could add an interface and make the runtime MetaClass ask the custom MetaClass or to provide an additional set of Properties and Methods at initialization, but then we get another set of interfaces and the runtime MetaClass msut keep track of the changes in case a new custom MetaClass is set.

2. let the runtime assign the runtime MetaClass to the custom MetaClass:

```

class MyCustomMetaClass extends MetaClass {
MyCustomMetaClass(MetaClass rmc, MetaClassRegistry mcr){
super(rmc,mcr)
}
...
}

```

```

interface MetaClass {
MetaClass getChainedMetaClass()
List getProperties()
...
}

```

```

class MetaClass {
    ...
    List getProperties(){return runtimeMetaClass.getProperties()}
    MetaClass getInnerMetaClass() {return runtimeMetaClass}
}

```

So this works much like our ProxyMetaClass. The behavior is much like the old MetaClass, just the signature of invokeMethod for example changes from (Object,String,Object[]) to (Object,String,Object[],ChainCall). It is then no longer possible to invoke a method using invokeMethod directly, it is then only for internal use. Which is no problem, as long as we keep an alternative way for Java as we currently have with InvokerHelper. Multiple chained MetaClasses are also possible this way, the implementation must just keep that in mind and iterate through all of them when making a call. This again is very unlike the ProxyMetaClass we currently have. I would strongly suggest to make MetaClass no interface then and to remove ProxyMetaClass, because the MetaClass then fulfills already the requirements of ProxyMetaClass. Another solution would be to not let it act as proxy, but to require an additional method:

```

class MetaClass {
    QueryableMetaClass getQueryableMetaClass() {
    MetaClass mc = this
    while (!(mc instanceof QueryableMetaClass)){
    mc = mc.getChainedMetaClass()
    }
    return mc;
    }
    ...
}

```

Where getChainedMetaClass behaves like above, meaning, it returns the next MetaClass, the last MetaClass is then the runtime implementation. This version means the usage is

```
metaClass.queryableMetaClass.getProperties()
```

instead of the old

```
metaClass.getProperties()
```

but it means also, that we can keep the MetaClass interface/class very clean and don't need to add other methods but the methods required for chaining, which we could even make final. Any additional behavior is then controlled by the interfaces I have shown above. This way we could make an MetaClass that intercepts methods, but not properties or fields. Or a version that does logging only on Properties, but does not interfere with normal method invocation. I am aware that this means to have many interface.. 9 then (Interceptor + Transformer + Logger for each of Property, Field and Method) or 6 (if Transformer and Interceptor are unified)

1. The custom behavior is unable to tell the difference between a call to super, a call from inside the class, or a normal call from a context outside (could be solved with additional different interfaces)

General Advantage

- implementation and custom behavior are separated
- we can split the runtime MetaClass in a mutable and immutable part and reconstruct the immutable part on demand
- custom MetaClasses becomes more lightweight, since no full initialization step is required for each custom MetaClass and the heavy part can be shared by multiple custom MetaClasses

More efficient custom MetaClasses

Additionally to the traditional Design we could also have a new Design, where we don't take part in the CallChain, but produce a MetaMethod (or property).

```

interface MetaClass2 {
    MetaMethod getMetaMethod(Object base, String name, Object[] args)
}

class MyMetaClass extends MetaClass implements MetaClass2 {
    MetaMethod getMetaMethod(Object base, String name, Object[] args) {
        if (name.equals("foo")) return myFooMetaMethod()
        return null
    }
}

```

which means this method is called in case of a cache miss, and not every time. Returning a MetaMethod we can control if we would like to add the method to the cache or not through the isCachable() method on MetaMethod. We could also change the interface a little and force the call to getMetaMethod even if there is no cache miss. The advantage is, we can still intercept methods, but in a more efficient way, because we don't need to throw a MissingMethodException. And we can use the cache directly if we do not force method selection through this class each time, which makes it very fast.

Proposal

So my proposal is to chain the MetaClasses as shown above, to have a more or less empty MetaClass class which does only the chaining and to have interfaces controlling all aspects of the method invocation (or for properties/fields) like I have shown with logger and transformer or MetaClass2.

Having metaClass.queryableMetaClass.getProperties() means to have less methods on MetaClass and since these MetaClasses do normally not add real methods. It would make sense to do so, but metaClass.getProperties() is not really a problem.

Variations

- Instead of chaining the MetaClasses like above, we could also have a central MetaClass and just add behavior using interface like the ones I shown (transformer, interceptor...). This would mean to change GroovyObject, because get/setMetaClass becomes meaningless then. If we use a proxy like mechanism, then we end in something that looks almost as the one above, but even more complicated.
- I tried to find a way to keep the call to super, but I was unable to find out how without using a ThreadLocal workaround, which I would like to avoid.

MetaClass Redesign (by blackdrag) part 2

This page last changed on Apr 28, 2007 by [paulk_asert](#).

In [MetaClass Redesign \(by blackdrag\)](#) I tried to show some ideas of how such a redesign might look like and what the advantages and disadvantages might be.

groovy.lang.MetaClass

In this part I want to show a more detailed version of one idea. that is a implementation based MetaClass is in front and the user can add custom behaviors. This limits the basic MetaClass interface to mere administrative methods

```
package groovy.lang;

public interface MetaClass {
    // MOP
    void addMOP(MetaClassObjectProtokoll mop);
    MetaClassObjectProtokoll removeMOP(MetaClassObjectProtokoll mop);

    // add methods and properties
    void addMethod(MetaMethod mm);
    void addProperty(MetaProperty mp);
    void addConstructor(MetaMethod mc);

    // listener for MetaClass changes
    void addMetaClassListener(MetaClassListener mcl);
    void removeMetaClassListener(MetaClassListener mcl);
    MetaClassListener[] getMetaClassListeners();
}
```

So the central point is addMOP, which allows to customize the method invocation for example. Besides this there are some methods for mutating the MetaClass (adding properties and such), a standard listener interface that allows to react to additions of properties for example. The implementation of this is not relevant for the user as it is thought as specification. The implementation depends on the Groovy runtime and might differ from other runtimes if there are ever such runtimes.

Usage of groovy.lang.MetaClass

If the user wants to influence the method invocation process for example, then he has to implement the MetaClassObjectProtokoll interface, which I will show later. In this section I want to show how to create a per instance MetaClass and how to use it.

changing a MetaClass in the registry

```
//old
coderegistry.setMetaClass(theClass,myMetaClass)
// new code
metaClass = registry.getMetaClass(theClass).metaClass.addBehavior(myMOP)
// or in one line
registry.getMetaClass(theClass).addMOP(myMOP)
```

So the one-line code becomes a more complex two-line code, unless we decide to change MetaClassRegistry to make that by itself.

creating and changing a per instance MetaClass

The old code was like this:

```
groovyObject.metaClass = myMetaClass
```

The new code will look like this:

```
groovyObject.metaClass.addMOP(myMOP)
```

So the change here is minimal. The code to create a per instance MetaClass is hidden by the implementation and might differ. This of course means that the class GroovyObjectSupport, which is part of groovy.lang has implementation knowledge inside. So a implementator must change this class to his version of the runtime.

Using the Listener to MetaClass changes

(add interface)

...

Consequences

A small collection of ideas for MOP 2

ideas by Jochen:

- we should no longer directly invoke methods like equals, setProperty and such.(see GROOVY-2635 for example)
- we should think about changing GroovyObject into a pure marker interface (if setProperty is needed in the logic we have problems)
- the MetaClass should be able to overwrite all methods including setProperty (this implies that we do not directly call setProperty)
- Comparable needs a rethought. This interface is not well to be used if you have to handle objects of different types
- it would be nice to be able to define only one operand like < or > instead of having to define both. At last being able to define these additionally
- we have to test if creating direct method call classes in call sites is doable. This would be like Reflector, but only for a single method, allowing the JIT to inline the method without much hassle. currently reflection means to have a border where the JIT can not really inline the call. Maybe we should also have different modes here, to allow users to still use reflection if this version has a problem on certain VMs or in certain scenarios
- as a design goal I would like to transform the MetaClass from a directly method invoking to a request oriented method returning class. This would be especially interesting for call site caching. The user could still write his invokeMethod method, but instead of calling that method directly in the Metaclass we would let the MetaClass return a method wrapper that can do the call to invokeMethod.
- I would also like to add a Listener to each MetaClass which allows other parts of the program to be informed when a MetaClass is changed in any kind. This could probably also be used to invalidate call site caches.
- A version information added to the MetaClass allows a very fast check for changes. We could also think about adding an additional version cache for method names. the idea here is to have a simple array and to let a call site cache the index to the array, which means the index is equal to a complete method signature or only to name. By checking the information in there(for example an referential identity check with the cached method) would allow the call site to quickly know if it needs to update or not. Such an array would grow other time if it needs to reflect dynamically added methods as well. So we should do this maybe only for the default methods.
- another design goal should be that if a code modifies a Metaclass, then as much changes as possible should be done by the thread modifying the metaclass. that means that this thread will for example call all the listeners, probably update caches, reorganize structures.. what ever
- The allow call sites faster access without going through the registry it would be good to have some kind of handle that can be used to directly access the MetaClass. This means that either the real MetaClass must not be replaced (only on the implementation side of course) or that the handle is update if a replacement happens.
- I would also like to add a module concept based on different meta class registries. For this a class using a module will contain some kind of information that will cause all code directly in this class to use only the meta classes from the registry and probably no per instance meta class. As some kind of namespace is required to differentiate one module from another we could couple this with the package "package foo with module" or by using a package like reference to a constant "module Foo.myRegistry" (Foo is a normal class, myRegistry is a final  public static field of type MetaClassRegistry or an alibi type. Annotations seem not to be fitted for this, as they would have to use enums, classes, primitives or strings and none but strings seem to fit that. enums won't work as I would have to define all possibilities in the runtime not allowing the user to define his own ideas of how it should work. Using classes would work, but where is the connection here to make it clear what we mean? primitives lack memorization, the user would have not only to remember a number, he would also have to make sure that it is not used somewhere else too. Strings are better, but there might still a name conflict. An Annotation would be doable if we want to make the module per class, but I am not sure this makes much sense.
- we should also look if we can not reduce the amount of MOP methods. We need one for each non public method, true, but we possibly do not need all these super\$ methods

- as Java still does direct calls we should think about adding the ability to methods to check if their MetaClass has a new version for this method. This way Java could easily access the meta class stored method. Of course we then have to also find a way to access the original method as well, as this method may be needed
- we should also think if we should add mechanisms we add for method calls should also be added for property access.
- we need to look at method caching in builders.... or maybe this is not needed as a builder might not be executed often
- for the meta class implementation we should also think about having special method selectors like I have in ClosureMetaClass.
- if we do call site caching, then we should probably remove the method caching inside the MetaClass, especially if we add specialized method selectors
- a point of discussion is if a method added to the parent classes metaclass should also affect the current metaclass or not.
- we need also to test if rewriting the method itself at runtime is possible and what it will cost.
- we need to investigate if inlining primitive type operations at compile time is possible. This can help avoiding boxing and direct usage of primitive types. Of course before doing something like that we would have to check the Metaclasses and all operations if this is allowed. If we do the idea with the method signature arrays we could also define constants for certain operations like +,-,*,/ to do the check very fast. If I do for example 1+1 I could compile this as: "if (Integer.metaclass.version==0 && Integer.metaclass.ops1==0) {iload 1; iload 1; iadd;}" 0 would show it is the default version and 1 is a numeric constant to see if the operation + is still the default or not.
- maybe the module concept can be used to enable calling private methods/fields. With this we could disable access to private from outside the class per default.. of course only after we solved the Closure problem (information loss with getProperty)
- invokeMethod should loose its double role for being a method missing and at the same time a direct invocation way from Java

Multiple Assignment Proposal

This page last changed on Nov 30, 2007 by [paulk_asert](#).

Introduction

This page looks at proposed changes to the Groovy language to support multiple assignment. Such support would allow for code such as:

```
a, b = b, a // will transparently handle any temporary storage

list = [1, 2, 3]
def (c, d, e) = list
assert c == 1 && d == 2 && e == 3
```

It is meant to be a discussion document, not a formal definition, we will work out the impact on the grammar etc. once we clarify our intention.

Single Assignment

Some existing declarations involving single assignment:

```
def a = 'a' // for examples below
def b = 'b' // for examples below
def c = 'c' // for examples below

//----- Existing: Java style, simple case (Proposal leaves unchanged)
def x1,y1,z1 = a // only z1 is equal to a, the others are undefined

assert x1 == null
assert y1 == null
assert z1 == a

//----- Existing: Java style, list case (Proposal leaves unchanged)
def x2, y2, z2 = [a,b,c] // only z2 is equal to [a,b,c], the others are undefined

assert x2 == null
assert y2 == null
assert z2 == [a,b,c]

//----- Existing: Java style, multiple equals case (Proposal leaves unchanged)
def x3 = a, y3 = b, z3 = c // obvious
assert x3 == a
assert y3 == b
assert z3 == c

//----- Existing: Java Java style, multiple lists case (Proposal leaves unchanged)
def x4 = [a,b], y4 = [b,c], z4 = [a,c] // obvious
assert x4 == [a,b]
assert y4 == [b,c]
assert z4 == [a,c]
```

Variable declarations

In order to not conflict with existing definitions, any variable declaration which wishes to make use of multiple assignments must surround the *'tuple'* of variable declarations in round brackets. Whenever such a round bracket is found, the compiler will match the tuple with a list. The list will be expected to be where it would be in the case of single assignment. The compiler will *'unpack'* the list into the tuple of variables.

```
def (x5,y5,z5) = [a,b,c] // common type goes before round brackets
def (x6,y6) = [a,b], z6 = c // x,y,z/5,6,7 must all be undefined
def list = [b, c]
def x7 = a, (y7, z7) = list // list can be explicit or implicit
```

```
assert x5 == a && x6 == a && x7 == a
assert y5 == b && y6 == b && y7 == b
assert z5 == c && z6 == c && z7 == c
```

Nested variations are also supported (this may be deferred initially):

```
def ((x8,y8),z8) = [[a,b],c]
assert x8 == a && y8 == b && z8 == c
```

Differing sized tuples and lists are catered for by ignoring extra list members and leaving any untargeted variables in the tuple set to null:

```
def (x9,y9,z9) = [a,b]
assert x9 == a && y9 == b && z9 == null
```

```
def (x10,y10,z10) = [a,b,c,d] // d unused
assert x10 == a && y10 == b && z10 == c
```

There can be at most one [at the end like varargs?] 'tuple spread' operator which takes the rest of the list:

```
def (first11,*rest11) = [a,b,c,d]

assert first11 == a
assert rest11 == [b, c, d]
```

Setting a bunch of variables to the same (or related) values is accomplished using normal list conventions:

```
def (x12,y12,z12) = [a] * 3
assert [x12, y12, z12] == [a, a, a]
```

```
def (x13,y13,z13) = 0..2
assert [x13, y13, z13] == [0, 1, 2]
```

```
def string = 'abcdefghi'
def (x14,y14,z14) = (1..3).collect{ string[0..it*2]}
assert [x14, y14, z14] == ["abc", "abcde", "abcdefg"]
```

The tuple list is strictly a list (apart from the nesting seen earlier) and may not contain assignments itself:

```
// INVALID
def (x15 = c, y15, z15) = [a,b,c]
```

Example involving nulls:

```
def (x16,y16,z16)
assert x16 == null
assert y16 == null
assert z16 == null
```

Examples involving real world use:

```
def (name, address1, address2, postcode) = myData.tokenize("\n").toList()
// acts like first/head/top
def (name) = myData.tokenize("\n").toList()
// equivalent to above but 'self documenting'
def (name, *ignored) = myData.tokenize("\n").toList()
```

Use in Expressions

The left hand side (LHS) of an expression involving the simple assignment operator, =, can be replaced with a tuple. In this case, the variables will be predefined or binding variables and the result of the RHS of the expression will be a (possibly coerced) list which will be unpacked into the tuple.

```
def list = [a, b]
```

```
def x17, y17
(x17, y17) = list
assert [x17, y17] == [a, b]
```

Where it is not ambiguous, the round brackets can be removed from the tuple list when used in such expressions, so the above could be written as:

```
x17, y17 = list // LHS turned into (x17, y17)
```

If the right hand side after any assignment operator contains a comma separated list of subexpressions, they will be assumed to make up a list (i.e. automatically turned into a list), so the above could be written as:

```
x17, y17 = a, b // RHS turned into [a, b]
```

[Note: the above probably requires lots of pouring over the grammar!]

If you find you need a tuple with different typed items inside, use an expression form rather than the variable declaration form which requires the types to be the same, e.g.:

```
def myMonth(){ [2000, "Jan", 1] }
String month
int day, year
(year, month, day) = myMonth()
```

Unlike with declarations, the LHS doesn't need to simply be a variable:

```
def map = [a:1, b:2]
(map.a, map.b) = [3, 4]
assert map == [a:3, b:4]

a = 10..15
i = 3
i, a[i] = i+1, 20
assert i == 4 && a[3] == 20 && a[4] == 14
```

Other examples which need to work:

```
x = 0
a, b, c = x, (x += 1), (x += 1)
assert [a, b, c] == [0, 1, 2]

year, month, day = "2007-03-20".split('-')
```

Other assignment operators

These may not be implemented initially, but we attempt to define them here. It includes these:

```
*= /= %= += -= <<= >>= >>>= &= ^= |=
```

First, a tuple on the LHS of a special assignment operator:

```
a, b *= 3
// form list [a, b] (tuple spread operator ignored here if present)
// call multiply() operator with arg 3
// unpack result into (a, b) tuple (spread operator applies to unpacking)

// example
def x18 = a, y18 = b
x18, *y18 *= 3
assert x18 = a
assert y18 = [b, a, b, a, b]
```

Now, an example with special treatment on the RHS:

```
yourObject *= 1, 2
// calls the multiply() method on yourObject with the list [1, 2]
```

As an alternative to the semantics described here, we could define 'a, b *= 3' to be the same as 'a *= 3; b *= 3'. This seems more useful but then if the semantics were to be consistent, then 'a, b = 3' should mean 'a = 3; b = 3'.

Use in Method declarations

No change, no grouping of method parameters is supported, i.e. the following is invalid:

```
// INVALID
def myMethod((a, b), c) { ... }
```

See Also

<http://jira.codehaus.org/browse/GROOVY-158>

Multiproject builds

This page last changed on Nov 25, 2007 by [paulk_asert](#).

I think the biggest challenge for our build system is how to implement multiproject builds. It is likely that most of users will do multiproject builds.

Vision

- Gant enables DRY for multiproject builds. This is were Ant has massively failed so far.
- Gant offers an intuitive way to write a multiproject build.
- Gant offers out of the box functionality for standard Java build tasks, which will grow from release to release.
- Gant offers maximum flexibility for customization. This is were Maven has massively failed.

Directory structure for multiproject builds

I think it is good to be very flexible regarding the possible directory structures. For Steven's use case it was good enough to assume that all projects are toplevel folders of the root folder. But there are many situations were this structure is not expressive enough and therefore should not be imposed.

In my last project we had a structure like:

- shared
- client
- ...
- services
 - services-shared
 - service1
 - ...
 - serviceN

And I'm sure there are much more complicated project structures out there which can't be changed or people don't want to change them. I propose to have only one assumption. There is a root folder were we (might) have a top level buildfile and all projects folder must be contained somewhere in this root folder.

Determining the projects to be build

Even if I do not consider pathological cases, automatically determining the projects to be build is not easy or at least not cheap. The rule would be that everything is a project which contains a buildfile. If we look at the projects layout described in the section above (nested projects), we would have to scan many, many folders to look for the buildfiles (e.g. src/main/java/org/codehaus/.....). We could try to be smart and have the policy not to look in folders with name src. But the name src is just a convention and could be changed by the user. We could read the configuration of a found project first and then continue our search. But there might be some folder in a project with many files and subfolder which just sits there (e.g. not in use any longer but people don't want to delete it). For every build that is triggered we would have to scan this folder to look for buildfiles. I think an easy way out of this problem is that people have to declare the projects to be build in a top level build file. This has also the advantage to have a static file containing the projects layout.

Implementation

I've been thinking a lot about this in the last days. I think I have a solution I'm happy with now. It is very much inspired from looking at the code of buildr.

Endresult

After processing all the build scripts, our new Gant will produce one classic Gant build script (in memory). So the complete multiproject build is finally described by exactly one flat list of targets which are related by dependency relations.

How to get there

Every subproject is represented by an instance of a Project object. This Project object is amongst other things a container for target object. For each Project object we create a set of default target instances (e.g. compile, test, ...) which we add to the Project object. Every Project must have a unique name (parent-project-name + project-name). The target instances of a Project object have the name: project-name+target-name.

Customization of the default targets

The default targets are not simple target objects. I think about creating for example a class Compile which extends the class Target. That means the compile target is a target but also a special compile object, that offers methods for customization and of course the action for actually doing the compile.

In our build script we could write for example `target("compile").with classpath`. Or even better `compile.with classpath`.

Adding new behavior

For this feature I guess we have to extend the classic Gant a little bit. We might make it a bit more Rakish. Basically I have two additional methods for a target in mind:

- `target("compile").dependsOn(otherTarget1, otherTarget2, ...)`
- `target("compile").addAction { ... }`

To add behavior we can now either create a new target in our build script and make a default target dependent on it. Or we can simply add behavior to an existing target, which gets executed after the default behavior is executed.

When I talk about the build script I have in mind that every subproject has its build script. That means the behavior changes described above only apply to the build of this particular subproject. If we want a more general change, we have a couple of possibilities. In the build script of a parent project we can say:

- something like `this.getChildren().each(add behavior)`
- `addRecursiveTarget(target)`

Interproject dependencies

I think we don't have to explicitly declare them. If there is such a dependency, it means somewhere in the build script of the project that depends on the other project, it refers to this other project anyway. For example `compile.with project("otherProject").classpath`.

Conclusions

Of course there are many details to hammer out. But I'm confident enough now to start implementing something based on the above ideas if we all think this makes sense.

Proposed Website Revamp

This page last changed on Apr 28, 2007 by paulk_asert.

New web page mockup

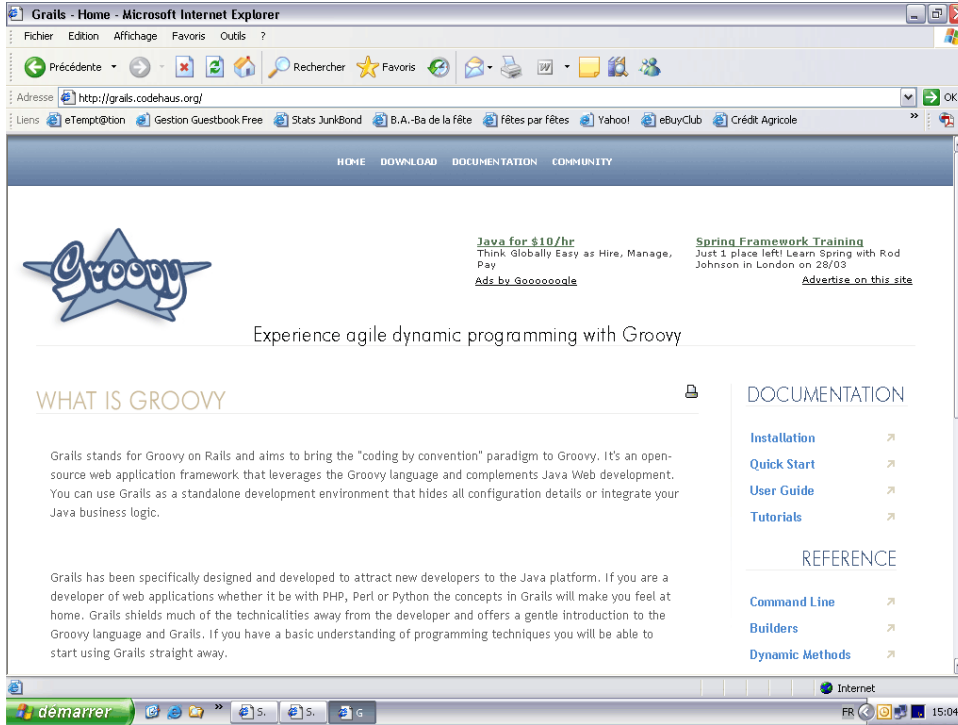

New logos in "grails" spirit



Archives

1.



2.



3.



4.



5.



6.



7.



8.



9.



10.



11.



12.



13.



14.









Roadmap

This page last changed on Mar 08, 2008 by paulk_asert.

Milestones of last release

Considering our limited human resources and time constraints, it is hard to give definitive and accurate estimates of the milestones we are going to release.



















For 1.5, we plan to follow the same beta / RC numbering scheme as used previously. It means we will be releasing a few betas, and a couple of RCs before release 1.1-final:

- 1.1-beta-1  2007 Apr 30 ([Detailed list of enhancements and bug fixes](#))
- 1.1-beta-2  2007 Jul 05 ([Detailed list of enhancements and bug fixes](#))
- 1.1-beta-3  2007 Sep 21 ([Detailed list of enhancements and bug fixes](#))
- 1.1-rc-1  2007 Oct 12 ([Detailed list of enhancements and bug fixes](#))
- 1.1-rc-2  2007 Nov 02 ([Detailed list of enhancements and bug fixes](#))
- 1.1-rc-3  2007 Nov 28 ([Detailed list of enhancements and bug fixes](#))
- 1.5-final  2007 Dec 07 ([Detailed list of enhancements and bug fixes](#))

Considering the breadth of improvements and the widened scope of the release, we decided to rebrand it as 1.5 instead of 1.1.

Roadmap

Here are the various features we are planning to implement/have implemented in the next minor release of Groovy (1.5.4):

jira.codehaus.org (50 issues)				
T	Key	Summary		Status
	GROOVY-1162	Can readLine from FileReader		Resolved
	GROOVY-2260	Wrong install : Exception in thread "Main Thread" java.lang.NoClassDefFoundError: Files\Groovy		Resolved
	GROOVY-2578	Duplicate imports		Closed
	GROOVY-2380	groovysh not working with JVM 1.4.2_06-b03		Closed
	GROOVY-2577	Problems in code completion when GroovyEditor is a part of MultiPageEditor		Closed
	GROOVY-2462	GroovyClassLoader does not parse files saved in utf-8		Closed
	GROOVY-2643	Delegate property is ignored by closure		Closed
	GROOVY-2647	Linenumber for exception during script execution is not reported		Closed
	GROOVY-2719	wrong method override is chosen		Closed
	GROOVY-2698	Method dispatch with overloaded methods for		Closed

		Java types doesn't choose the most specific method		
	GROOVY-2658	Overloaded methods mismatched arguments		Closed
	GROOVY-2700	Joint compiler incorrectly assumes that subclass is a Java class		Closed
	GROOVY-2637	Enums error		Closed
	GROOVY-2726	Missing 2 else's in InvokerHelper.setAttribute()		Closed
	GROOVY-2604	Annotations on a local variable crash GroovyC		Closed
	GROOVY-1348	Patch to provide access to Script Object in GroovyScriptEngine		Closed
	GROOVY-2424	Stackoverflow with groovy & ant		Closed
	GROOVY-2432	Setting unscoped log level to ALL can cause infiinte loop and stack overflow		Closed
	GROOVY-2523	compiler complains for loop has empty body		Closed
	GROOVY-2560	sum, min and friends should work on the same types that collect, each and their friends work on.		Closed
	GROOVY-2564	startGroovy error with solaris		Closed
	GROOVY-2567	Antbuilder/Groovy ant task that uses forking java task causes StackOverflow in ANT script		Closed
	GROOVY-2568	Questionable code in ReflectionCache		Closed
	GROOVY-2569	the equals operator(==) error		Closed
	GROOVY-2584	Can't get groovysh to run in a cygwin xterm under Windows XP.		Closed
	GROOVY-2585	Can not insert nulls into the table using Sql.execute		Closed
	GROOVY-2586	scrollPane() should not allow multiple components as children		Closed
	GROOVY-2591	Groovy Ant Task is not executing Groovy Test Cases as the Command Line does		Closed
	GROOVY-2592	XmlNodePrinter doesn't escape special characters in attributes		Closed
	GROOVY-2593	DataSet's should allowing sorting		Closed
	GROOVY-2596	Found a deadlock when I have mutiple threads running a groovy script		Closed
	GROOVY-2598	eachLine should support a 2 arg closure with index being second arg		Closed
	GROOVY-2617	Unable to use spread operator with maps		Closed

	GROOVY-2620	Process.consumeProcessXX methods do not handle newline properly.		Closed
	GROOVY-2628	Command line option for classpath (--cp/--classpath) is broken on Windows		Closed
	GROOVY-2654	Joint compilation Groovy class stubs missing exception information		Closed
	GROOVY-2678	Installation of Groovy in a Path the contains spaces doesn't work (eg "Program Files")		Closed
	GROOVY-2685	CLIBuilder regression since 1.5.1		Closed
	GROOVY-2689	Strange coercion bug in Groovy shell		Closed
	GROOVY-2690	groovy.bat fail to start script that are in a folder with a dash follow with "s"		Closed
	GROOVY-2692	AntBuilder: support import task and allow to define targets		Closed
	GROOVY-2694	CachedClass.CachedMethodComparatorWithString doesn't work on non Sun JDK		Closed
	GROOVY-2699	GDJ links are wrong		Closed
	GROOVY-2705	ProxyGenerator.instantiateDelegate fails when there are overridden protected methods		Closed
	GROOVY-2718	CLONE -JAVA_HOME with Backslash at end results in Error JAVA_HOME not set		Closed
	GROOVY-2721	index-all page for Groovy JDK DocGenerator		Closed
	GROOVY-2723	XStream cannot loadXML from GroovyScriptEngine created classes		Closed
	GROOVY-2735	Allow to set ClassLoader explicitly for ProxyGenerator class		Closed
	GROOVY-2744	It would be useful to have a way to flip posix behavior on/off for CliBuilder without exposing specific Commons CLI classes		Closed
	GROOVY-2745	the gsp template can not support unicode(utf-8)		Closed

Here are the various features we are planning to implement in the next major release of Groovy (1.6):

jira.codehaus.org (97 issues)				
T	Key	Summary		Status
	GROOVY-2575	getLineNumber()/getColumnNumber()		Open

	GROOVY-1605	on PropertyExpression always returns -1 Have a delete() method in File that deletes all subdirectories and contained files		Open
	GROOVY-2606	Error processing uncompiled classes		Open
	GROOVY-2583	"object is not an instance of declaring class" thrown invoking a method on Groovy class, wrapped in a Spring proxy		Open
	GROOVY-2720	Convert org.codehaus.groovy.control.Phases to an Enum		Open
	GROOVY-2733	Generify collections' related methods in GDK		Open
	GROOVY-2651	groovy-swt: No finish/cancel callbacks in WizardDialog		Open
	GROOVY-2746	Static import of method with default parameter value: MissingMethodException		Open
	GROOVY-2540	generic method parameter support		Open
	GROOVY-2696	Joint compiler does not honour JavaBean spec for boolean properties		Open
	GROOVY-2688	Never pass null for the arguments to invokeMethod or methodMissing		Open
	GROOVY-2736	stub generator fails to generate stub for empty enum		Open
	GROOVY-2686	Can't call a Closure in a Closure's Delegeate		Open
	GROOVY-2725	Semicolon required for certain generics declarations		Open
	GROOVY-2565	Exception with inheritance and private method calls from a closure		Open
	GROOVY-2693	Generics and joint compilation: method types are not fully respected		Open
	GROOVY-1131	Character ++ and -- should be closed under their type		Open
	GROOVY-2305	Process.getText() GDK method blocks on some operating systems.		Open
	GROOVY-2602	TimeDuration should override toString		Open
	GROOVY-1648	VerifyError when doing strange things with closures		Open
	GROOVY-1327	Closures in a derived class can't access package private fields of the		Open

		base class in the same package.		
	GROOVY-1516	comments and indentation broken in Emacs Groovy mode		Open
	GROOVY-2634	Using Java Generics		Open
	GROOVY-2535	lost LineNumberTable in groovyc-produced bytecode		Open
	GROOVY-2680	property read accessor defined via metaClass does not work without parameter list terminator in closure		Open
	GROOVY-2138	let groovy support concatting objects and strings with plus sign		Open
	GROOVY-2437	Groovyc ant task compiles closures twice		Reopened
	GROOVY-1642	Script needs to be able to retrieve the full path of "its" file		Reopened
	GROOVY-2491	Concurrency performance changes break closure method resolution in Grails		Resolved
	GROOVY-2695	Problem in Groovy MOP causing stack overflows in Grails		Resolved
	GROOVY-2594	Allow factories to intercept and handle child closures		Resolved
	GROOVY-1074	Better exception reporting with line number		Resolved
	GROOVY-2679	Allow to omit square brackets in annotations when list has just one element (similar to Java)		Resolved
	GROOVY-2712	SwingBuilder cannot bind to the 'value' property of a scrollbar		Resolved
	GROOVY-2644	startGroovy.bat appends CLASSPATH to jvm's startup classpath		Resolved
	GROOVY-2555	Calling abstract super method causes stack overflow instead of compiler error		Resolved
	GROOVY-2749	eachLine and splitEachLine work without encoding		Resolved
	GROOVY-2742	Behavior of Closure in GString needs to be documented		Resolved
	GROOVY-2714	multiline string with "" or "" error causes problem in groovysh		Resolved
	GROOVY-1132	match vs match[] handling inconsistent for eachMatch vs. =~		Resolved
	GROOVY-1630	each(Matcher,Closure) doesn't work for patterns with groups; plus other		Resolved

	GROOVY-2765	regex issues [minor breaking change] Intersect on Collection should try to keep similar type of original collection (like plus)		Resolved
	GROOVY-2764	Plus on Collection tries to keep similar type of original collection but not for LinkedList		Resolved
	GROOVY-2603	['a'] as LinkedHashMap throws GroovyCastException		Resolved
	GROOVY-2548	-cp include in bash script startGroovy do not include all needed jars		Resolved
	GROOVY-2739	Compilation error: BUG! exception in phase 'semantic analysis' in source unit		Resolved
	GROOVY-2747	Joint Compilation fails on the command line		Resolved
	GROOVY-2542	Missing hyphen in XML declaration encoding created by StreamingMarkupBuilder		Resolved
	GROOVY-2770	encoding specific versions of newWriter and withWriter wrap the created OutputStreamWriter in a BufferedWriter which hides encoding		Resolved
	GROOVY-2573	ConfigSlurper does not process property files with nested properties correctly		Resolved
	GROOVY-2483	groovy.bat can not set system property		Resolved
	GROOVY-2622	Calling a vararg method from a closure throws an exception		Closed
	GROOVY-2380	groovysh not working with JVM 1.4.2_06-b03		Closed
	GROOVY-2532	Building GroovyDoc Runs Out of Heap Space		Closed
	GROOVY-2691	Annotations are not working		Closed
	GROOVY-2643	Delegate property is ignored by closure		Closed
	GROOVY-2719	wrong method override is chosen		Closed
	GROOVY-2658	Overloaded methods mismatched arguments		Closed
	GROOVY-2700	Joint compiler incorrectly assumes that subclass is a Java class		Closed
	GROOVY-2637	Enums error		Closed
	GROOVY-2726	Missing 2 else's in InvokerHelper.setAttribute()		Closed
	GROOVY-2604	Annotations on a local variable crash GroovyC		Closed

	GROOVY-1348	Patch to provide access to Script Object in GroovyScriptEngine		Closed
	GROOVY-2432	Setting unscoped log level to ALL can cause infiinte loop and stack overflow		Closed
	GROOVY-2523	compiler complains for loop has empty body		Closed
	GROOVY-2560	sum, min and friends should work on the same types that collect, each and their friends work on.		Closed
	GROOVY-2564	startGroovy error with solaris		Closed
	GROOVY-2567	Antbuilder/Groovy ant task that uses forking java task causes StackOverflow in ANT script		Closed
	GROOVY-2569	the equals operator(==) error		Closed
	GROOVY-2585	Can not insert nulls into the table using Sql.execute		Closed
	GROOVY-2586	scrollPane() should not allow multiple components as children		Closed
	GROOVY-2591	Groovy Ant Task is not executing Groovy Test Cases as the Command Line does		Closed
	GROOVY-2592	XmlNodePrinter doesn't escape special characters in attributes		Closed
	GROOVY-2593	DataSet's should allowing sorting		Closed
	GROOVY-2598	eachLine should support a 2 arg closure with index being second arg		Closed
	GROOVY-2617	Unable to use spread operator with maps		Closed
	GROOVY-2620	Process.consumeProcessXX methods do not handle newline properly.		Closed
	GROOVY-2628	Command line option for classpath (--cp/--classpath) is broken on Windows		Closed
	GROOVY-2654	Joint compilation Groovy class stubs missing exception information		Closed
	GROOVY-2678	Installation of Groovy in a Path the contains spaces doesn't work (eg "Program Files")		Closed
	GROOVY-2685	CLIBuilder regression since 1.5.1		Closed
	GROOVY-2689	Strange coercion bug in Groovy shell		Closed
	GROOVY-2690	groovy.bat faile to start script that are in a folder with a dash follow with "s"		Closed

	GROOVY-2694	CachedClass.CachedMethodComparatorWithString doesn't work on non Sun JDK		Closed
	GROOVY-2699	GDK links are wrong		Closed
	GROOVY-2718	CLONE -JAVA_HOME with Backslash at end results in Error JAVA_HOME not set		Closed
	GROOVY-2721	index-all page for Groovy JDK DocGenerator		Closed
	GROOVY-2723	XStream cannot loadXML from GroovyScriptEngine created classes		Closed
	GROOVY-2735	Allow to set ClassLoader explicitly for ProxyGenerator class		Closed
	GROOVY-2744	It would be useful to have a way to flip posix behavior on/off for CliBuilder without exposing specific Commons CLI classes		Closed
	GROOVY-2745	the gsp template can not support unicode(utf-8)		Closed
	GROOVY-2766	methodMissing is invoked twice		Closed
	GROOVY-2755	The runtime must instantiate or avoid the nulled MetaClass		Closed
	GROOVY-2615	Patches for line / column information for various AST Nodes		Closed
	GROOVY-2646	changed behaviour of isImplicitThis() in MethodCallExpression		Closed
	GROOVY-2697	line/column information for parenthesised expression		Closed
	GROOVY-2748	line/column information patch for several nodes		Closed

Not Yet Documented

This page last changed on Dec 03, 2007 by [glaforge](#).

The following items need documentation.

When documenting, please create a page for each and link to it.

- Generics
- [Closures](#)
 - Closure's variable resolving strategy
- Joint Groovy/Java compiler, and its options and impact on the Groovyc Ant task
- Explain the new Foo(a:1, b:2) shortcut notation calls setA() and setB() after new Foo() is created and initialized, and that this is not an atomic thread-safe operation
- Type handling
 - 'as' keyword with its different meanings
 - conversion vs coercion vs autoboxing
 - closure and map coercion to interfaces and classes
 - general typing approach (explicit static typing vs duck typing)
 - static methods called from instances (see GROOVY-1706)
 - Conversion rules, in all their complexity
- [Swing Builder](#)
- more builder documentation - [Builders](#)
- Scoping
 - handling of "return, break, and continue"
 - open blocks vs closed blocks
 - Name scoping rules
 - scoping rules for Closures
- method dispatch algorithm
- Method calls and property references, in all their complexity
- 'special' variables like `-owner-` in `Closures-`, `'out'` in Groovlets etc.
- Class member naming conventions, and other JVM interfaces

Also, when you are working on a page that is unfinished, label that page with "TODO" and it will appear in this list:

-  [FactoryBuilderSupport](#)
-  [Feature Wish List](#)
-  [Gldapwrap - Usage](#)
-  [Not Yet Documented](#)
-  [SwingBuilder.button](#)

Gldapwrap - Usage

This page last changed on Sep 25, 2007 by [tomstrummer](#).



This package is not actively maintained, but it will be re-released once it has been reworked as time permits.

Gldapwrap - Usage

To use Gldapwrap, you need to make sure the Gldapwrap jar is in your classpath as well as the Spring LDAP jars (provided in the download). An easy way to do this is to put the jars in `~/groovy/lib/`.

First thing you need to do is define a schema class. A schema class is just an ordinary POGO.

```
class MyLdapEntry
{
List objectclass
String distinguisheName
}
```

That's all you need to do to define a schema.

Next is to create a `GldapwrapTemplate` which is basically the details of the LDAP server you want to connect to.

```
import gldapwrap.GldapwrapTemplate

def template = new GldapwrapTemplate(
url: "ldap://example.com",
base: "dc=example,dc=com",
userDn: "cn=admin,dc=example,dc=com",
password: "secret"
)
```

Next you need to inject the template into your schema class.

```
import gldapwrap.GldapwrapInjector(MyLdapEntry, template)
```

Now you can do searches.

```
List entries = MyLdapEntry.find() // Find all entries at base

entries = MyLdapEntry.find(
filter: "(objectclass=person)",
searchScope: javax.naming.directory.SearchControls.SUBTREE_SCOPE
) // Find all people in the whole directory

entries = MyLdapEntry.find(
filter: "(objectclass=person)",
searchScope: javax.naming.directory.SearchControls.SUBTREE_SCOPE
base: "ou=People"
countLimit: 50
) // Find the first 50 people in the directory under the people OU
```

See [Searching](#) for more detail about searching.

Sources and tests reorganization and distribution

This page last changed on Feb 27, 2007 by [paulk_asert](#).

This page documents the current plan for reorganizing the Groovy code-base based on the discussions and initial decisions from [Groovy devcon3](#).

Introduction

We are going to reorganize the sources and tests to separate:

- Regression tests from 1.0 from new tests, or from TCK related tests
- Language-related classes, from library-related ones

This also means we should separate more cleanly:

- The core language classes
- The library classes
- The module content

Core languages classes are everything related to the core concepts of the language as well as the GDK. Library classes contain classes related to various APIs like JMX, Swing, and such. While module content usually require additional dependencies than the ones of the JDK and also usually follow their own release cycle.

Separating sources also means creating different artifact deliverables:

- groovy-core (including "jarjar-ed" ASM and Antlr)
- groovy-gdk

Having a small groovy-core library is particularly interesting for those wishing to integrate Groovy in their Java applications.

Regarding the tests, we should separate the 1.0 tests in a dedicated folder, while creating new folders for including "Groovy in Action" tests, new tests for 1.1 (with tests specific to Java 1.5 features), as well as tests for the TCK of JSR-241.

Current Plan

Step 1

Replace the current Maven 1 build with an Ant build.

Step 2

- split src/main into src/core and src/bundled (for bundled modules?)
- split main.pom into core.pom, bundled.pom and external.pom (or thirdparty.pom?)
- use a naming convention for any tests that require a third party library that we don't intend to include in the complete install

E.g. for now, assuming AntBuilder lives in bundled (not core) we could split the current AntTest in two, e.g. AntBuilderTest and AntBuilderExternalLibsTest. Any dependencies for AntBuilderTest must have compile or runtime scope in bundled.pom. The functionality represented in AntBuilderTest is what we advertise as "runs out of the box - for a full install". Anything in AntBuilderExternalLibsTest would also use jars in the external.pom file. We can then create a page like the ant optional task [library dependencies page](#) but I suggest we use pom format rather than listing jars individually.

So, going back to the AntBuilder example, the main functionality for AntBuilder would be covered in the AntBuilderTest which might require dependencies such as ant.jar and ant-launcher.jar. If we wanted ant-junit.jar to also work out of the box we would have a test for it in AntBuilderTest and include ant-junit.jar as another of our dependencies. If not, we could still have a test for it in AntBuilderExternalLibsTest and it would get mentioned in external.pom. Ant tasks are probably not a good example here but as another example, any SqlTests which rely on a real database would be in

SqlXxxExternalLibsTest. Unit tests or system/integration tests that only rely on JDBC core libraries would be part of either core or bundled poms.

Testing Guide

This page last changed on Jun 08, 2007 by [paulk_asert](#).

Welcome to the Groovy Testing Guide. It contains information of relevance to those writing developer tests or systems and acceptance tests.

- [Groovy Mocks](#)
 - [Developer Testing using Closures instead of Mocks](#)
 - [Developer Testing using Maps and Expandos instead of Mocks](#)
 - [Mocking Static Methods using Groovy](#)
 - [Using MockFor and StubFor](#) — used to assist (typically unit) testing of classes in isolation
- [Integrating TPTP](#) — some hints for using the Eclipse TPTP facilities with Groovy
- [Model-based testing using ModelJUnit](#)
- [Test Combinations](#) — some hints for using Groovy to assist generate test data in particular all combinations and all pair combinations
 - [Effectiveness of testing combinations with all pairs](#)
- [Test Coverage](#) — is a useful measure of the effectiveness of unit tests and can be derived for Groovy tests
 - [Code Coverage with Cobertura](#)
- [Testing Web Applications](#) — how to use NekoHTML, HtmlUnit, Watij and WebTest to test web applications
- [Testing Web Services](#) — how to test Web Services using Groovy directly and in conjunction with WebTest and SoapUI
- [Unit Testing](#) — shows how Groovy may be used to simplify unit testing
 - [Using JUnit 4 with Groovy](#)
- [Using Other Testing Frameworks](#) — Examples of integration with a number of Java testing frameworks
 - [Using EasyMock with Groovy](#)
 - [Using Instinct with Groovy](#)
 - [Using JBehave with Groovy](#)
 - [Using JDummy with Groovy](#)
 - [Using JMock with Groovy](#)
 - [Using JMockit with Groovy](#)
 - [Using Popper with Groovy](#)
 - [Using RMock with Groovy](#)
 - [Using TestNG with Groovy](#)
- [Using Testing Frameworks with Groovy](#) — explores testing features of Groovy and some other testing frameworks
 - [Using GSpec with Groovy](#)

Groovy Mocks

Groovy has excellent built-in support for a range of mocking alternatives. Before considering those, let's review some relevant terms.

Terms

Collaborator

An ordinary Groovy or Java class that's instance or class methods are to be called. Calling them can be time consuming or produce side effects that are unwanted when testing (e.g. database operations).

Caller

A Groovy Object that calls methods on the Collaborator, i.e. collaborates with it.

Mock

An object that can be used to augment the Collaborator. Method calls to the Collaborator will be handled by the Mock, showing a *demanded* behavior. Method calls are *expected* to occur *strictly* in the *demanded* sequence with a given *range* of cardinality. The use of a Mock implicitly ends with *verifying* the expectations.

Stub

Much like a Mock but the *expectation* about sequences of method calls on the Collaborator is *loose*, i.e. calls may occur out of the *demanded* order as long as the *ranges* of cardinality are met. The use of a Stub does not end with an implicit verification since the stubbing effect is typically asserted on the Caller. An explicit call to *verify* can be issued to assert all *demanded* method calls have been effected with the specified cardinality.

An extended example

System under test

We will explore a system under test inspired from the [JBehave](#) currency example.

Our system makes use of a base currency class used to represent the currency of a particular country:

```
class Currency {
public static final Currency USD = new Currency("USD")
public static final Currency EUR = new Currency("EUR")
private String currencyCode
private Currency(String currencyCode) {
this.currencyCode = currencyCode
}
public String toString() {
return currencyCode
}
}
```

and a base exchange rate class which encapsulates buying and selling rates for a currency:

```
class ExchangeRate {
```

```

final double fromRate
final double toRate
public ExchangeRate(double fromRate, double toRate) {
this.fromRate = fromRate
this.toRate = toRate
}
}

```

We will make use of an exchange rate service collaborator to retrieve the exchange rates for a particular country:

```

interface ExchangeRateService {
ExchangeRate retrieveRate(Currency c)
}

```

Our class under test is a currency converter. It makes use of the following exception:

```

class InvalidAmountException extends Exception {
public InvalidAmountException(String message) {super(message);}
}

```

and conforms to the following interface:

```

interface CurrencyConverter {
double convertFromSterling(double amount, Currency toCurrency) throws InvalidAmountException
double convertToSterling(double amount, Currency fromCurrency) throws InvalidAmountException
}

```

Here is our class under test.

```

class SterlingCurrencyConverter implements CurrencyConverter {
private ExchangeRateService exchangeRateService

public SterlingCurrencyConverter(ExchangeRateService exchangeRateService) {
this.exchangeRateService = exchangeRateService;
}

private double convert(double amount, double rate) throws InvalidAmountException {
if (amount < 0) {
throw new InvalidAmountException("amount must be non-negative")
}
return amount * rate
}

public double convertFromSterling(double amount, finance.Currency toCurrency) throws
InvalidAmountException {
return convert(amount, exchangeRateService.retrieveRate(toCurrency).fromRate)
}

public double convertToSterling(double amount, finance.Currency fromCurrency) throws
InvalidAmountException {
return convert(amount, exchangeRateService.retrieveRate(fromCurrency).toRate)
}
}

```

Mocking using Map coercion

When using Java, Dynamic mocking frameworks are very popular. A key reason for this is that it is hard work creating custom hand-crafted mocks using Java. Such frameworks can be used easily with Groovy if you choose (as shown in this [extended example](#)) but creating custom mocks is much easier in Groovy. You can often get away with simple maps or closure to build your custom mocks.

Let's consider maps first.

By using maps or expandos, we can incorporate desired behaviour of a collaborator very easily as shown here:

```
def service = [retrieveRate:{ new ExchangeRate(1.45, 0.57) }] as ExchangeRateService
def sterlingConverter = new SterlingCurrencyConverter(service)
double convertedAmount = sterlingConverter.convertFromSterling(10.0, Currency.USD);
assert convertedAmount == 14.50
```

For more details, see [Developer Testing using Maps and Expandos instead of Mocks](#).

Mocking using Closure coercion

Alternatively, we can use closures:

```
service = { new ExchangeRate(1.55, 0.56) } as ExchangeRateService
sterlingConverter = new SterlingCurrencyConverter(service)
convertedAmount = sterlingConverter.convertFromSterling(10.0, Currency.USD);
assert convertedAmount == 15.50
```

For more details, see [Developer Testing using Closures instead of Mocks](#).

Mocking using MockFor and StubFor

If we need the full power of a dynamic mocking framework, Groovy has a built-in framework which makes use of meta-programming to define the behaviour of the collaborator. An example is shown here:

```
import groovy.mock.interceptor.*

def mockContextClass = new MockFor(DummyExchangeRateService)
mockContextClass.demand.retrieveRate(1){ new ExchangeRate(1.65, 0.55) }
class DummyExchangeRateService implements ExchangeRateService {
ExchangeRate retrieveRate(Currency currency){}
}
mockContextClass.use {
def dummyService = new DummyExchangeRateService()
sterlingConverter = new SterlingCurrencyConverter(dummyService)
convertedAmount = sterlingConverter.convertFromSterling(10.0, Currency.USD)
assert convertedAmount == 16.50
}
```

For more details, see [Using MockFor and StubFor](#).

Instance-style MockFor and StubFor

You can also use MockFor and StubFor in a more traditional style by creating instances as follows:

```
mockContext1 = new MockFor(ExchangeRateService)
mockContext1.demand.retrieveRate(1){ new ExchangeRate(1.75, 0.54) }
def dummyService1 = mockContext1.proxyInstance()
def sterlingConverter1 = new SterlingCurrencyConverter(dummyService1)
convertedAmount1 = sterlingConverter1.convertFromSterling(10.0, Currency.USD)
mockContext1.verify(dummyService1)
assert convertedAmount1 == 17.50

mockContext2 = new MockFor(ExchangeRateService)
mockContext2.demand.retrieveRate(1){ new ExchangeRate(1.85, 0.53) }
def dummyService2 = mockContext2.proxyInstance()
def sterlingConverter2 = new SterlingCurrencyConverter(dummyService2)
convertedAmount2 = sterlingConverter2.convertFromSterling(10.0, Currency.USD)
mockContext2.verify(dummyService2)
assert convertedAmount2 == 18.50
```

Developer Testing using Closures instead of Mocks

This page last changed on Dec 28, 2006 by [paulk_asert](#).

Groovy's 'as' operator can be used with closures in a neat way which is great for developer testing in simple scenarios. We haven't found this technique to be so powerful that we want to do away with dynamic mocking, but it can be very useful in simple cases none-the-less.

Suppose we are using [Interface Oriented Design](#) and as sometimes advocated we have defined a number of short interfaces as per below. (Note: we ignore the discussion about whether interfaces are as valuable a design approach when using dynamic languages that support duck-typing.)

```
interface Logger { def log(message) }
interface Helper { def doSomething(param) }
interface Factory { Helper getInstance() }
```

Now, using a coding style typically used with [dependency injection](#) (as you might use with [Spring](#)), we might code up an application class as follows:

```
class MyApp {
private factory
private logger
MyApp(Factory factory, Logger logger) {
this.logger = logger
this.factory = factory
}
def doMyLogic(param) {
factory.getInstance().doSomething(param)
logger.log('Something done with: ' + param)
}
}
```

To testing this, we could use [Groovy's built-in mocking](#) or some other Java-based dynamic mocking framework. Alternatively, we could write our own static mocks. But no one does that these days I hear you say! Well, they never had the ease of using closures, which bring dynamic power to static mocks, so here we go:

```
def param = 'DUMMY STRING'
def logger = { message -> assert message == 'Something done with: ' + param }
def helper = { assert it == param }
def factory = { helper as Helper }
def myApp = new MyApp(factory as Factory, logger as Logger)
myApp.doMyLogic(param)
```

That was easy. Behind the scenes, Groovy creates a proxy object for us that implements the interface and is backed by the closure.

Easy yes, however, the technique as described above assumes our interfaces all have one method. What about more complex examples? Well, the 'as' method works with Maps of closures too. Suppose our helper interface was defined as follows:

```
interface Helper {
def doSomething(param)
def doSomethingElse(param)
}
```

And our application modified to use both methods:

```
...
def doMyLogic(param) {
def helper = factory.getInstance()
helper.doSomething(param)
helper.doSomethingElse(param)
logger.log('Something done with: ' + param)
}
...
```

We simply use a map of closures with the key used being the same name as the methods of the interface, like so:

```
...
def helperMethod = { assert it == param }
def helper = [doSomething:helperMethod, doSomethingElse:helperMethod]
// as before
def factory = { helper as Helper }
...
```

Still easy!

For this simple example, where we wanted each method to be the same (i.e. implementing the same code) we could have done away with the map altogether, e.g. the following would work, making each method be backed by the closure:

```
def factory = { helperMethod as Helper }
```

More Information

See also:

- [Developer Testing using Maps and Expandos instead of Mocks](#)
- [Groovy way to implement interfaces](#)

Developer Testing using Maps and Expandos instead of Mocks

This page last changed on Dec 10, 2006 by [paulk_asert](#).

Suppose we are trying to test the following application:

```
class MyApp {
  def factory
  def logger
  def doBusinessLogic(param) {
  def myObj = factory.instance
  myObj.doSomething(param)
  myObj.doSomethingElse(param)
  logger.log('Something done with: ' + param)
  }
}
```

We might be tempted to replace logger and factory with Groovy's [built-in mocks](#), but it turns out that Maps or Expandos are often sufficiently powerful enough in Groovy that we don't need full blown dynamic mocks for this example.

Instead of a mock for logger, we can use an Expando as follows:

```
...
def logger = new Expando()
logger.log = { msg -> assert msg == 'Something done with: ' + param }
...
```

Here the expected behaviour for our production code is captured within a Closure. (When using TDD, this closure would force the production code we saw in our original code to be created.)

Instead of a mock for factory, we can use a simple map as follows:

```
...
def factory = [instance: businessObj]
...
```

Here, `businessObj` is the object we want the factory to return, though in general this could be a Closure similar to what we did for the Expando above.

Putting this altogether yields (after some refactoring) the following complete test:

```
class MyAppTest extends GroovyTestCase {
  void testDoesBusinessLogic() {
  // triangulate
  checkDoesBusinessLogic "case1"
  checkDoesBusinessLogic "case2"
  }
  private checkDoesBusinessLogic(param) {
  def logger = setUpLoggingExpectations(param)
  def businessObj = setUpBusinessObjectExpectations(param)
  def factory = [instance: businessObj]
  def cut = new MyApp(logger:logger, factory:factory)
  cut.doBusinessLogic(param)
  }
  private setUpLoggingExpectations(param) {
  def shouldProduceCorrectLogMessage =
  { msg -> assert msg == 'Something done with: ' + param }
  def logger = new Expando()
  logger.log = shouldProduceCorrectLogMessage
  return logger
  }
  private setUpBusinessObjectExpectations(param) {
  def shouldBeCalledWithInputParam = { assert it == param }
  def myObj = new Expando()
  myObj.doSomething = shouldBeCalledWithInputParam
  myObj.doSomethingElse = shouldBeCalledWithInputParam
  return myObj
  }
```

```
}  
}
```

See also: [Developer Testing using Closures instead of Mocks](#)

Mocking Static Methods using Groovy

This page last changed on Aug 22, 2007 by [paulk_asert](#).

Suppose you wish to test a class which is dependent on a static call. Is there a way to mock out that call?

Yes, there are two suggested approaches:

- Using EMC
- Using JMockit (requires Java 6)

Using EMC

Here we are calling `Arrays.sort()` directly - normally that would be the problematic code within your class under test.

```
// non-mocked first to prove it works normally
String[] things = ['dog', 'ant', 'bee', 'cat']
Arrays.sort(things)
println things // => {"ant", "bee", "cat", "dog"}

Arrays.metaClass.'static'.sort = { a ->
a[0] = 'ewe'
a[1] = 'fox'
}

things = ['dog', 'ant', 'bee', 'cat']
Arrays.sort(things)
println things // => {"ewe", "fox", "bee", "cat"}
```

More details about this approach: [ExpandoMetaClass - Adding static methods](#)

Using JMockit

If you are in a position to use Java 6, you should also consider using JMockit.

```
// require(url:'https://jmockit.dev.java.net', jar='jmockit.jar')
// require(url:'https://jmockit.dev.java.net', jar='jmockit-asm2.jar')
// needs to be run with "-javaagent:jmockit.jar"
// and "-Xbootclasspath/a:jmockit.jar;.jmockit-asm2.jar"
// The bootclasspath option is only required because we are mocking
// a class from the java.* package (part of the bootclasspath for Java)

import mockit.Mockit

// non-mocked first to show normal case
String[] things = ['dog', 'ant', 'bee', 'cat']
Arrays.sort(things)
println things // => {"ant", "bee", "cat", "dog"}

Mockit.redefineMethods(Arrays, MockArrays)

things = ['dog', 'ant', 'bee', 'cat']
Arrays.sort(things)
println things // => {"dog", "elk", "ape", "cat"}
```

Where `MockArrays` is the following Java class:

```
// Java
public class MockArrays {
public static void sort(Object[] a) {
a[1] = "elk";
a[2] = "ape";
}
}
```

We use a Java class here because otherwise JMockit tries to replace other `GroovyObject` methods (e.g. `getMetaClass`, `invokeMethod`, ...) and won't find them inside the `java.util.Arrays` class. Obviously, if you're redefining a Groovy class, you can use another Groovy class.

More details: [Using JMockit with Groovy](#).

Using MockFor and StubFor

This page last changed on Nov 20, 2007 by [paulk_asert](#).

Groovy Mocks

Mock objects are used to assist (typically unit) testing of classes in isolation.

The Groovy Mock resides in the `groovy.mock.interceptor` package. It is an all-groovy mock testing library.

In principle, it is used like this:

```
import groovy.mock.interceptor.MockFor

def mocker = new MockFor(Collaborator.class) // create the Mock support
mocker.demand.one(1..2) { 1 } // demand the 'one' method one or two times,
returning 1
mocker.demand.two() { 2 } // demand the 'two' method exactly once, returning 2
mocker.use { // start using the Mock
def caller = new Caller() // caller will call Collaborator
assertEquals 1, caller.collaborateOne() // will call Collaborator.one
assertEquals 1, caller.collaborateOne() // will call Collaborator.one
assertEquals 2, caller.collaborateTwo() // will call Collaborator.two
} // implicit verify for strict expectation here
```

Groovy Mocks were inspired by [EasyMock](#).

Find background information about Mocks and endo-testing under [XP2000 conference paper](#).

For an extended example, see [Using Testing Frameworks with Groovy](#)

Features

- typical mock style of *failing early*
- mocks instance and class methods
- mocks final methods and final Collaborators
- mocks Groovy and Java Collaborators (but Caller must be groovy)
- can mock all objects of a given class (or a single Groovy object)
- mocks even if Collaborator cannot be injected into the Caller
- mocks even if Collaborator is not accessible on the Caller (no getter)
- demanded calls specified via recording calls on the Demand object (EasyMock style).
- cardinality specified as Ranges, default is `1..1`; 'optional' can be achieved with `0..1`
- behavior specified via Closures, allowing static or calculated return values, throwing exceptions, asserting argument values, etc. (even tricky sequence constraints by sharing state in the testMethod scope between the behavior Closures)
- matching parameter list specified via Closure's parameter list, supporting typed or untyped params, default params, and varargs.
- not dependent on any external mock library

For an extensive list of usages see the [unit tests that show how to use the mock package](#).

Integrating TPTP

This page last changed on Sep 27, 2006 by [paulk_asert](#).

This page provides some hints for using the Eclipse TPTP facilities with Groovy.

The Eclipse Testing and Performance Tools Platform ([TPTP](#)) project addresses the entire test and performance life cycle, from early testing to production application monitoring, including test editing and execution, monitoring, tracing and profiling, and log analysis. It is primarily aimed at the Java-aware tester but can also be used with Groovy.

As one example, if you follow the introductory tutorial included in the TPTP documentation called: [Creating a datapool driven JUnit test application](#), you will create a datapool application which lets you invoke data-driven JUnit tests. If you simply replace the Java code with Groovy code you can have data-driven Groovy tests. Here is what your test might look like:

```
import org.eclipse.hyades.models.common.datapool.impl.Common_DatapoolFactoryImpl;

class Groovy_TPTP extends GroovyTestCase {
def dpIterator

void setUp() throws Exception {
def dpFactory = new Common_DatapoolFactoryImpl()
def datapool = dpFactory.load(new java.io.File("GIA_TPTP\\shoppingCartDatapool.datapool"),false)
dpIterator =
dpFactory.open(datapool,"org.eclipse.hyades.datapool.iterator.DatapoolIteratorSequentialPrivate")
dpIterator.dpInitialize(datapool,0)
}

void testShoppingCartConstructor() {
def cart = new MyShoppingCart()
while(!dpIterator.dpDone()) {
def description = dpIterator.dpCurrent().getCell("Description").stringValue
def expectedPrice = dpIterator.dpCurrent().getCell("Price").doubleValue
def actualPrice = cart.myFlowers[description]
assertNotNull(actualPrice)
assertEquals(expectedPrice, actualPrice.doubleValue())
dpIterator.dpNext()
}
}
}
```

Here is what your output might look like:

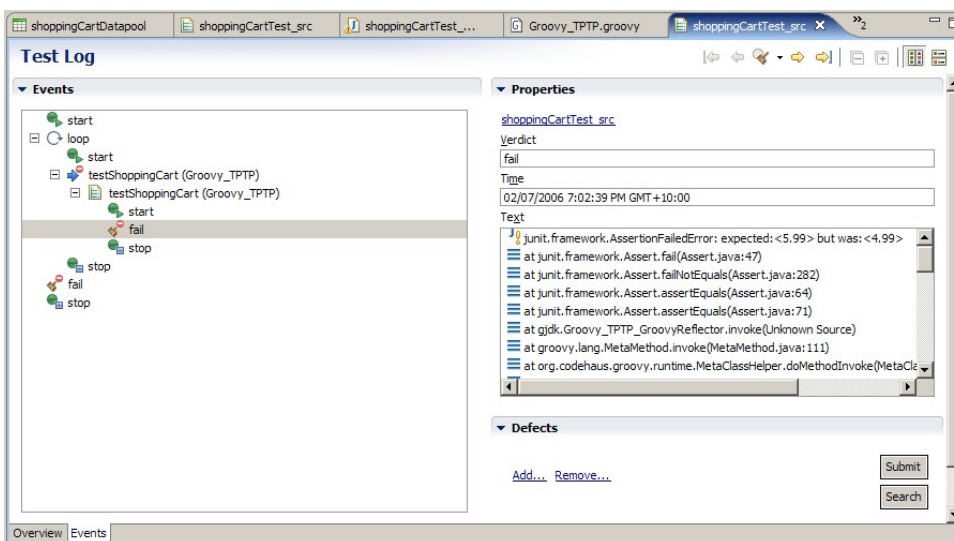

In addition to allowing you to write datapool-aware Groovy tests, by making use of `GroovyTestSuite` and `AllTestSuite` you can visually select Groovy test cases to run within TPTP using its looping and selection

features. This lets non-Groovy aware team members create new test cases from primitives which Groovy-aware team members can create.

For more details, see [GINA](#) or the [TPTP](#) web site.

Model-based testing using ModelJUnit

This page last changed on Dec 21, 2007 by [paulk_asert](#).

[ModelJUnit](#) is a Java library that extends JUnit to support [model-based testing](#).

In this example, we will consider how to model and test a simple vending machine. The system under test is illustrated by the following state diagram:

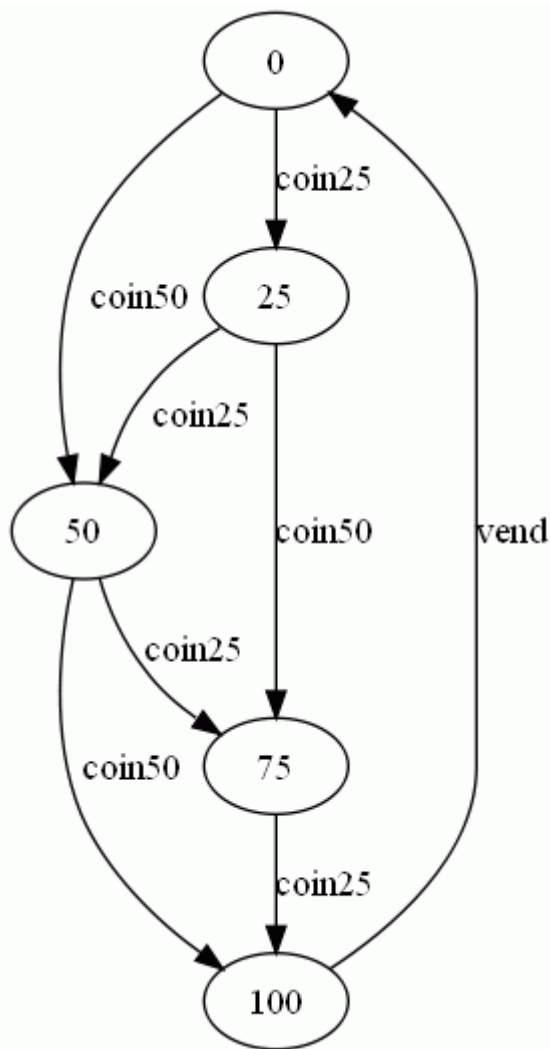

The `VendingMachineModel` class models this system. Our script makes use of the `RandomTester` class to generate some tests for this model. The total code looks like this:

```
// require junit.jar
// require modeljunit.jar

import net.sourceforge.czt.modeljunit.*
import net.sourceforge.czt.modeljunit.coverage.*

class VendingMachineModel implements FsmModel {
def state = 0 // 0,25,50,75,100

void reset(boolean testing) {state = 0}

boolean vendGuard() {state == 100}
@Action void vend() {state = 0}

boolean coin25Guard() {state <= 75}
@Action void coin25() {state += 25}
```

```

boolean coin50Guard() {state <= 50}
@Action void coin50() {state += 50}
}

def tester = new RandomTester(new VendingMachineModel())
tester.buildGraph()
tester.addListener "verbose"
tester.generate 20

```

When we run this script, we will see the randomly generated test transitions. The output will be:

```

done (0, coin50, 50)
done (50, coin25, 75)
done (75, coin25, 100)
done (100, vend, 0)
done Random reset(true)
done (0, coin25, 25)
done (25, coin50, 75)
done (75, coin25, 100)
done (100, vend, 0)
done (0, coin25, 25)
done (25, coin50, 75)
done (75, coin25, 100)
done (100, vend, 0)
done (0, coin50, 50)
done (50, coin50, 100)
done (100, vend, 0)
done (0, coin25, 25)
done (25, coin50, 75)
done (75, coin25, 100)
done (100, vend, 0)

```

We can optionally obtain additional metrics about the test:

```

// ... as before to create the tester

def metrics = [
new ActionCoverage(),
new StateCoverage(),
new TransitionCoverage(),
new TransitionPairCoverage()
]
metrics.each {
tester.addCoverageMetric it
}

tester.addListener "verbose"
tester.generate 20

println 'Metrics Summary:'
metrics.each {
tester.model.printMessage "$it.name was $it"
}

```

This generates the following:

```

Metrics Summary:
Action Coverage was 3/3
State Coverage was 5/5
Transition Coverage was 7/8
Transition-Pair Coverage was 9/12

```

We can also add a graph listener with the following code:

```

def graphListener = tester.model.getListener("graph")
graphListener.printGraphDot "vending.dot"

```

```
println "Graph contains " + graphListener.graph.numVertices() +  
" states and " + graphListener.graph.numEdges() + " transitions."
```

When run, a [graphviz](#) dot file is produced (corresponding to the image above) and the output is:

```
Graph contains 5 states and 8 transitions.
```

See also: [State Pattern](#)

Test Combinations

This page last changed on Sep 27, 2006 by [paulk_asert](#).

This page provides some hints for using Groovy to assist generate test data in particular all combinations and all pair combinations.

Frequently you may have to test combinations, e.g. a method has several enumerations for its arguments or a web page has several dropdowns with multiple values, or you have assorted hardware combinations (as in the example below). You could manually work out the combinations, or you can let Groovy help you. We are going to look at two ways groovy can help you:

- By generating your test cases in Groovy
- By reading and invoking XML data produced by a specialist tool called Whitch

The most ([effective](#)) way to test large numbers of combinations is called "all pairs".

Combinations algorithms in Groovy

Here is a script which calculates all combinations for a particular example:

```
results = new HashSet()
def buildCombinations(Map partialCombinations, inputsLeft) {
def first = inputsLeft.entrySet().toList().get(0)
def partialResults = [ ]
first.value.each{
def next = [(first.key):it]
next.putAll(partialCombinations)
partialResults << next
}
if (inputsLeft.size() == 1) {
results.addAll(partialResults)
} else {
partialResults.each{
rest = inputsLeft.clone()
rest.remove(first.key)
buildCombinations(it, rest)
}
}
}

def configurations = [memory:['256M', '512M', '1G', '2G'],
disk:['5G', '10G'],
os:['MacOS', 'Windows', 'Linux']]

buildCombinations([], configurations)
println results.size() + " combinations:"
results.each{ println it }
```

Running this script yields the following results:

```
24 combinations:
["memory":"512M", "os":"MacOS", "disk":"5G"]
["memory":"2G", "os":"Linux", "disk":"5G"]
["memory":"1G", "os":"Linux", "disk":"10G"]
["memory":"512M", "os":"Linux", "disk":"5G"]
["memory":"512M", "os":"Windows", "disk":"10G"]
["memory":"2G", "os":"MacOS", "disk":"10G"]
["memory":"1G", "os":"Windows", "disk":"5G"]
["memory":"256M", "os":"MacOS", "disk":"5G"]
["memory":"1G", "os":"Linux", "disk":"5G"]
["memory":"2G", "os":"Windows", "disk":"10G"]
["memory":"512M", "os":"MacOS", "disk":"10G"]
["memory":"256M", "os":"Windows", "disk":"5G"]
["memory":"256M", "os":"Windows", "disk":"10G"]
["memory":"1G", "os":"MacOS", "disk":"10G"]
```

```
["memory":"1G", "os":"Windows", "disk":"10G"]
["memory":"512M", "os":"Windows", "disk":"5G"]
["memory":"256M", "os":"Linux", "disk":"10G"]
["memory":"2G", "os":"Windows", "disk":"5G"]
["memory":"2G", "os":"MacOS", "disk":"5G"]
["memory":"2G", "os":"Linux", "disk":"10G"]
["memory":"256M", "os":"Linux", "disk":"5G"]
["memory":"1G", "os":"MacOS", "disk":"5G"]
["memory":"256M", "os":"MacOS", "disk":"10G"]
["memory":"512M", "os":"Linux", "disk":"10G"]
```

Note: you would normally invoke your test method rather than just printing out the test case as we have done here.

You could then use this information as the input for a data-driven test.

It turns out though, that running all of these combinations is often overkill. If for instance, some bug occurs when memory is low on Windows, then both of the following test cases will illustrate the bug:

```
["memory":"256M", "os":"Windows", "disk":"5G"]
["memory":"256M", "os":"Windows", "disk":"10G"]
```

A technique known as [all pairs](#) or orthogonal array testing suggests using just a subset of the input data combinations with high likelihood of finding all bugs and greatly reduced test execution time.

To calculate all pairs for the above example, you could use the following script:

```
initialResults = new HashSet()
results = new HashSet()

def buildPairs(Map partialCombinations, inputsLeft) {
  def first = getFirstEntry(inputsLeft)
  def partialResults = [ ]
  first.value.each{
    def next = [(first.key):it]
    def nextEntry = getFirstEntry(next)
    next.putAll(partialCombinations)
    partialResults << next
  }
  if (inputsLeft.size() == 1) {
    initialResults.addAll(partialResults)
  } else {
    partialResults.each{
      rest = inputsLeft.clone()
      rest.remove(first.key)
      buildPairs(it, rest)
    }
  }
}

def adjustPairs() {
  results = initialResults.clone()
  initialResults.each {
    def rest = results.clone()
    rest.remove(it)
    if (allPairsCovered(it, rest)) {
      results.remove(it)
    }
  }
}

def getFirstEntry(Map map) {
  return map.entrySet().toList().get(0)
}

def getAllPairsFromMap(map) {
  if (map.size() <= 1) return null
}
```

```

def allPairs = new HashSet()
def first = getFirstEntry(map)
def rest = map.clone()
rest.remove(first.key)
rest.each{
def nextPair = new HashSet()
nextPair << first
nextPair << it
allPairs << nextPair
}
def restPairs = getAllPairsFromMap(rest)
if (restPairs != null) {
allPairs.addAll(restPairs)
}
return allPairs
}

boolean allPairsCovered(candidate, remaining) {
def totalCount = 0
def pairCombos = getAllPairsFromMap(candidate)
pairCombos.each { candidatePair ->
def pairFound = false
def pairs = candidatePair.toList()
for (it in remaining) {
def entries = it.entrySet()
if (!pairFound && entries.contains(pairs[0]) && entries.contains(pairs[1])) {
pairFound = true
totalCount++
}
}
}
return (totalCount == pairCombos.size())
}

def updateUsedPairs(map) {
getAllPairsFromMap(map).each{ usedPairs << it }
}

def configurations = [memory:['256M', '512M', '1G', '2G'],
disk:['5G', '10G'],
os:['MacOS', 'Windows', 'Linux']]

buildPairs([], configurations)
adjustPairs()
println results.size() + " pairs:"
results.each{ println it }

```

This code is not optimised. It builds all combinations and then removes unneeded pairs. We could greatly reduce the amount of code by restructuring our all combinations example and then calling that - but we wanted to make each example standalone. Here is the result of running this script:

```

12 pairs:
["memory":"1G", "os":"Linux", "disk":"5G"]
["memory":"512M", "os":"MacOS", "disk":"10G"]
["memory":"256M", "os":"Windows", "disk":"10G"]
["memory":"1G", "os":"Windows", "disk":"10G"]
["memory":"512M", "os":"Windows", "disk":"5G"]
["memory":"2G", "os":"MacOS", "disk":"5G"]
["memory":"2G", "os":"Windows", "disk":"5G"]
["memory":"2G", "os":"Linux", "disk":"10G"]
["memory":"1G", "os":"MacOS", "disk":"5G"]
["memory":"256M", "os":"Linux", "disk":"5G"]
["memory":"512M", "os":"Linux", "disk":"10G"]
["memory":"256M", "os":"MacOS", "disk":"10G"]

```

We saved half of the combinations. This might not seem like much but when the number of input items is large or the number of alternatives for each input data is large, the saving can be substantial.

If this is still too many combinations, we have one more additional algorithm that is sometimes useful. We call it minimal pairs. Rather than making sure each possible pair combination is covered, minimal pairs only adds a new test data item into the results if it introduces a new pair combination not previously seen. This doesn't guarantee all pairs are covered but tends to produce a minimal selection of interesting pairs across the possible combinations. Here is the script:

```
results = new HashSet()
usedPairs = new HashSet()

def buildUniquePairs(Map partialCombinations, inputsLeft) {
def first = getFirstEntry(inputsLeft)
def partialResults = [ ]
first.value.each{
def next = [(first.key):it]
def nextEntry = getFirstEntry(next)
next.putAll(partialCombinations)
partialResults << next
}
if (inputsLeft.size() == 1) {
partialResults.each {
if (!containsUsedPairs(it)) {
updateUsedPairs(it)
results << it
}
}
} else {
partialResults.each{
rest = inputsLeft.clone()
rest.remove(first.key)
buildUniquePairs(it, rest)
}
}
}

def getFirstEntry(map) {
return map.entrySet().toList().get(0)
}

def getAllPairsFromMap(map) {
if (map.size() <= 1) return null
def allPairs = new HashSet()
def first = getFirstEntry(map)
def rest = map.clone()
rest.remove(first.key)
rest.each{
def nextPair = new HashSet()
nextPair << first
nextPair << it
allPairs << nextPair
}
def restPairs = getAllPairsFromMap(rest)
if (restPairs != null) {
allPairs.addAll(restPairs)
}
return allPairs
}

boolean containsUsedPairs(map) {
if (map.size() <= 1) return false
def unpaired = true
getAllPairsFromMap(map).each {
if (unpaired) {
if (usedPairs.contains(it)) unpaired = false
}
}
}
```

```

}
}
return !unpaired
}

def updateUsedPairs(map) {
getAllPairsFromMap(map).each{ usedPairs << it }
}

def configurations = [memory:['256M', '512M', '1G', '2G'],
disk:['5G', '10G'],
os:['MacOS', 'Windows', 'Linux']]

buildUniquePairs([], configurations)
println results.size() + " pairs:"
results.each{ println it }

```

Here is the result of running the script:

```

6 pairs:
["memory":"512M", "os":"Windows", "disk":"5G"]
["memory":"256M", "os":"MacOS", "disk":"5G"]
["memory":"2G", "os":"Linux", "disk":"10G"]
["memory":"1G", "os":"Linux", "disk":"5G"]
["memory":"512M", "os":"MacOS", "disk":"10G"]
["memory":"256M", "os":"Windows", "disk":"10G"]

```

Combinations using Whitch

The IBM alphaworks site hosts the Intelligent Test Case Handler ([WHITCH](#)) project. From their website: *This technology is an Eclipse plug-in for generation and manipulation of test input data or configurations. It can be used to minimize the amount of testing while maintaining complete coverage of interacting variables. Intelligent Test Case Handler enables the user to generate small test suites with strong coverage properties, choose regression suites, and perform other useful operations for the creation of systematic software test plans.*

You should follow the instructions on the WHITCH site for installing the plug-in into your Eclipse directory (we used Eclipse 3.2). The user guide is then part of Eclipse help and details the features and instructions for using the tool. We will simply highlight how you might decide to use it.

First create a new Whitch file. File -> New -> Other... -> Whitch file. You must select the project and provide a file name. We used 'groovy.whitch'.

Now add your types similar to the earlier example. You should end up with something like:

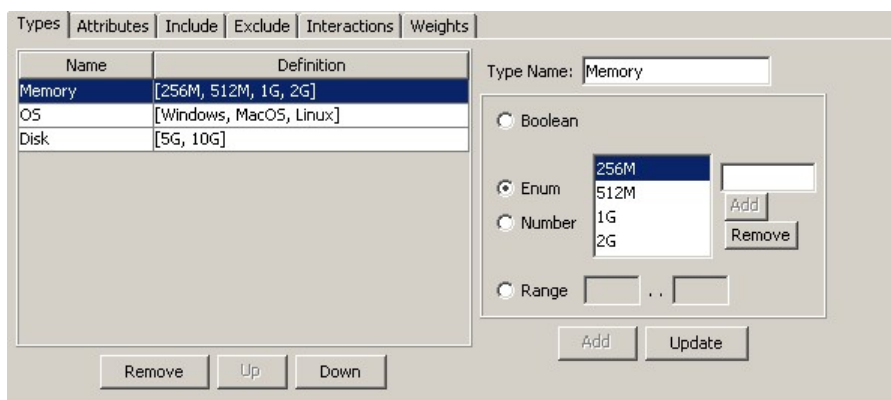

Now add some attributes corresponding to the types you have just added. The result will be something like:

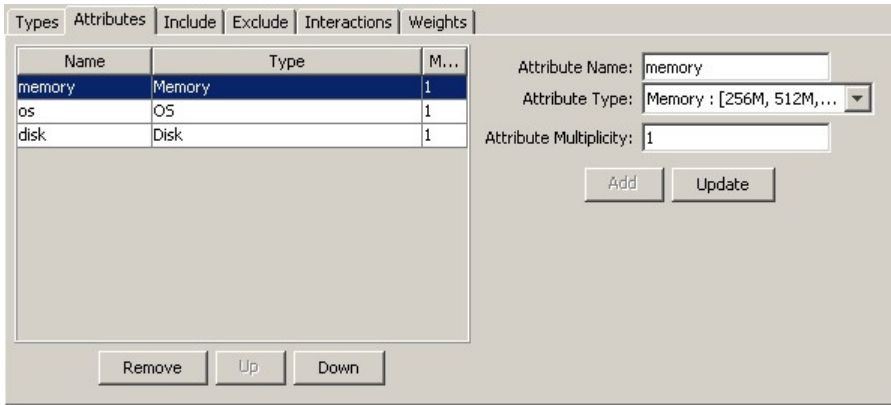

Now select Whitch -> Build. Type in a test suite name. We used 'AllPairs' and select an interaction level of 2 (for pairs) as follows:

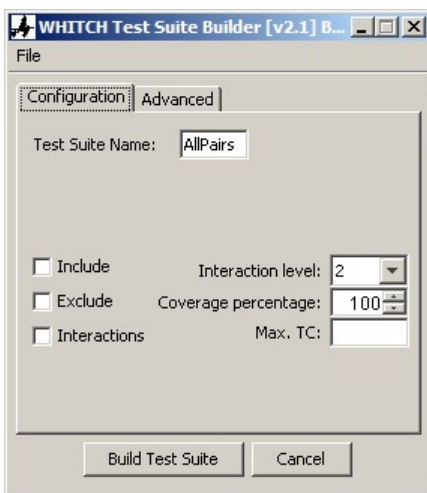

Now click 'Build Test Suite' to obtain your results:

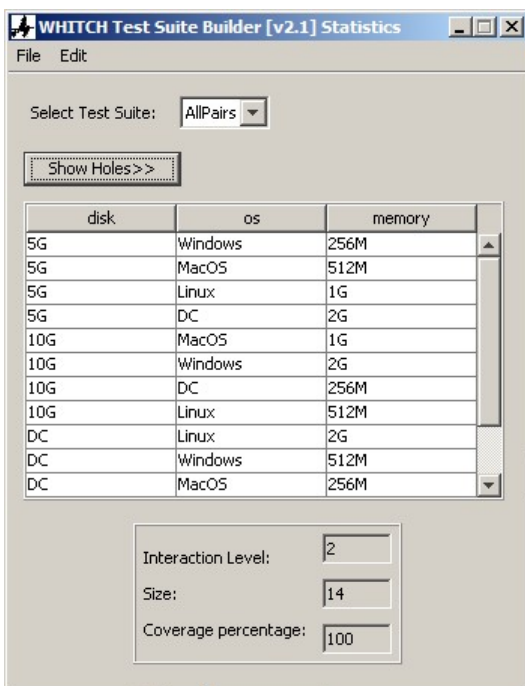

Now save your Whitch file. The result will be that the test cases are now stored into an XML file.

Note: We have not shown any advanced Whitch features, e.g. it lets you add test cases in the Include tab which must always be added into the test suite and test cases which are not possible into the Exclude tab. It also lets you try to reduce your test case size, give weightings, choose different algorithms for test case generation and more. See the Whitch user guide for more details.

```
def testsuite = new XmlSlurper().parse(new File('groovy.whitch'))
def attributes = testsuite.Model.Profile.Attribute
def testcases = testsuite.TestCases.TestCase
println testcases.size() + ' pairs:'
testcases.each{ testcase ->
def map = [:]
(0..2).each{
def key = attributes[it].@name.toString()
def value = testcase.Value[it].@val.toString()
map.put(key, value)
}
println map
}
```

Running this script yields the following results:

```
14 pairs:
["memory":"256M", "os":"Windows", "disk":"5G"]
["memory":"512M", "os":"MacOS", "disk":"5G"]
["memory":"1G", "os":"Linux", "disk":"5G"]
["memory":"2G", "os":"DC.DC", "disk":"5G"]
["memory":"1G", "os":"MacOS", "disk":"10G"]
["memory":"2G", "os":"Windows", "disk":"10G"]
["memory":"256M", "os":"DC.DC", "disk":"10G"]
["memory":"512M", "os":"Linux", "disk":"10G"]
["memory":"2G", "os":"Linux", "disk":"DC.DC"]
["memory":"512M", "os":"Windows", "disk":"DC.DC"]
["memory":"256M", "os":"MacOS", "disk":"DC.DC"]
["memory":"256M", "os":"Linux", "disk":"DC.DC"]
["memory":"2G", "os":"MacOS", "disk":"DC.DC"]
["memory":"1G", "os":"Windows", "disk":"DC.DC"]
```

Note: the value "DC.DC" indicates a don't care value and can be replaced with any value for that field.

Effectiveness of testing combinations with all pairs

This page last changed on Aug 20, 2006 by emprove@gmail.com.

Rather than testing every possible combination of things, all pairs simplifies the exercise to testing every pair of things which reduces the complexity significantly, for example instead of 700,000 possible combinations, all pairs would be about 500 combinations.

While this reduces the number of tests, does it help find bugs? All pairs works because when things break, they have a tendency to break because of the faulty interaction of two things rather than 3 or more. A long term study of medical device failures found a strong correlation for this. For all the failures reported, a quarter of them would have been found with all pairs testing. The true result is probably much better than this, because a lot of the failure reports did not have enough detail to allow proper analysis. Of the detailed reports, 98% of the failures would have been found with all pairs testing! The paper, "Failure Modes in Medical Devices", is at csrc.ncsi.nist.gov/staff/kuhn/final-rqse.pdf

If you do all pairs testing, you could still use minimal pairs to get better test effectiveness. By starting your tests with all the minimal pairs first, this would give a good broad coverage of combinations. The remaining all pairs combinations could then be used to finish the exercise.

Test Coverage

This page last changed on Sep 27, 2006 by [paulk_asert](#).

Code coverage is a useful measure of the effectiveness of unit tests and can be derived for Groovy tests.

Consider the following Groovy code:



```
class BiggestPairCalc
{
int sumBiggestPair(int a, int b, int c) {
def op1 = a
def op2 = b
if (c > a) {
op1 = c
} else if (c > b) {
op2 = c
}
return op1 + op2
}
}
```

And the following test:

```
class BiggestPairCalcTest extends GroovyTestCase
{
void testSumBiggestPair() {
def calc = new BiggestPairCalc()
assertEquals(9, calc.sumBiggestPair(5, 4, 1))
}
}
```

If you use [Cobertura](#) to perform your coverage, the resulting report might look like:

Coverage Report - BiggestPairCalc

Classes in this File	Line Coverage	Branch Coverage	Complexity
BiggestPairCalc	71% 	100% 	0

1	class BiggestPairCalc
2	{
3	int sumBiggestPair(int a, int b, int c) {
4	1 def op1 = a
5	1 def op2 = b
6	1 if (c > a) {
7	0 op1 = c
8	1 } else if (c > b) {
9	0 op2 = c
10	}
11	1 return op1 + op2
12	}
13	}

Your [Ant](#) build file to make all this happen might look like:

```
<?xml version="1.0"?>
<project name="sample" default="coverage-report" basedir=".">
<!-- set up properties, paths, taskdefs, prepare targets -->
[details deleted]

<!-- compile java (if you have any) and groovy source -->
<target name="compile" depends="prepare">
<javac srcdir="${dir.src}" destdir="${dir.build}" debug="true">
<classpath refid="project.classpath"/>
</javac>
<groovy srcdir="${dir.src}" destdir="${dir.build}" stacktrace="true">
<classpath refid="project.classpath"/>
</groovy>
</target>

<!-- instrument already compiled class files -->
```

```

<target name="instrument" depends="compile" >
<cobertura-instrument todir="target/instrumented-classes">
<fileset dir="${dir.build}">
<include name="**/*.class"/>
</fileset>
</cobertura-instrument>
</target>

<!-- run all junit tests using the instrumented classes -->
<target name="cover-test" depends="instrument">
<mkdir dir="${dir.report}/cobertura" />
<junit printsummary="yes" haltonerror="no" haltonfailure="no" fork="yes">
<formatter type="plain" usefile="false"/>
<batchtest>
<fileset dir="target/instrumented-classes" includes="**/*Test.class" />
</batchtest>
<classpath refid="cover-test.classpath"/>
</junit>
</target>

<!-- create the html reports -->
<target name="coverage-report" depends="cover-test">
<cobertura-report srcdir="${dir.src}" destdir="${dir.report}/cobertura"/>
</target>
</project>

```

For more details, see [GINA](#) or the [Cobertura](#) web site or [Code Coverage with Cobertura](#).

Code Coverage with Cobertura

This page last changed on Oct 10, 2006 by [paulk_asert](#).

Starting with v1.8, Cobertura will create detailed reports for Groovy source. It can be download from <http://cobertura.sourceforge.net/download.html>

Below is an example build file for using Cobertura in your project.

Notice that you must compile your groovy source into .class files so that Cobertura can add instrumentation to those .class files.

build.xml

```
<?xml version="1.0"?>
<project name="sample" default="jar" basedir=". ">
<!-- properties for project directory structure -->
<property name="dir.src" value="src"/>
<property name="dir.build" value="build"/>
<property name="dir.dist" value="dist"/>
<property name="dir.lib" value="lib"/>

<!-- setup a project classpath that includes the external libs -->\
<path id="project.classpath">
<!-- include the classes in this project -->
<pathelement location="${dir.build}"/>
<!-- include external libraries -->
<fileset dir="${dir.lib}" includes="**/*.jar"/>
</path>

<!-- add external tasks -->
<taskdef name="groovyc" classpathref="project.classpath"
classname="org.codehaus.groovy.ant.Groovyc"/>
<taskdef name="groovy" classpathref="project.classpath" classname="org.codehaus.groovy.ant.Groovy"/
>

<!-- create output directories -->
<target name="prepare">
<mkdir dir="${dir.build}"/>
</target>

<!-- clean -->
<target name="clean" description="Remove all generated files.">
<delete dir="${dir.build}"/>
</target>

<!-- compile java (if you have any) and groovy source -->
<target name="runGroovyC" depends="prepare,copyResourceFiles">
<javac srcdir="${dir.src}" destdir="${dir.build}">
<classpath refid="project.classpath"/>
</javac>
<groovyc srcdir="${dir.src}" destdir="${dir.build}" stacktrace="true">
<classpath refid="project.classpath"/>
</groovyc>

<!-- work around if groovyc tasks doesn't work right
<java classname="org.codehaus.groovy.ant.Groovyc" fork="yes" maxmemory="${maxmemory}">
<classpath refid="project.classpath"/>
<arg value="${dir.build}"/>
<arg value="${dir.src}"/>
</java>
-->
</target>

<!--=====
<!-- Cobertura Test Coverage Tool -->
```

```

<!--=====-->
<path id="cobertura.classpath">
<fileset dir="${dir.lib}/cobertura" includes="**/*.jar"/>
<pathelement location="target/instrumented-classes"/>
<pathelement location="${dir.src}"/>
</path>

<taskdef classpath="${dir.lib}/cobertura/cobertura.jar" resource="tasks.properties"
classpathref="cobertura.classpath"/>

<!-- adds the logging code to the already compiled class files -->
<target name="instrument" >
<delete quiet="false" failonerror="false">
<fileset dir="target/instrumented-classes" includes="**/*.class"/>
</delete>
<cobertura-instrument todir="target/instrumented-classes">
<fileset dir="${dir.build}">
<include name="**/*.class"/>
<exclude name="**/*Test.class"/>
</fileset>
</cobertura-instrument>
</target>

<!-- setup class path to include instrumented classes before non-instrumented ones -->
<path id="cover-test.classpath">
<fileset dir="${dir.lib}" includes="**/*.jar"/>
<pathelement location="target/instrumented-classes"/>
<pathelement location="${dir.build}"/>
</path>

<!-- run all my junit tests using the instrumented classes -->
<target name="cover-test" depends="instrument">
<mkdir dir="${dir.report}/cobertura" />
<junit printsummary="yes" haltonerror="no" haltonfailure="no" fork="yes">
<formatter type="plain" usefile="false"/>
<batchtest>
<fileset dir="target/instrumented-classes" includes="**/*Test.class" />
</batchtest>
<classpath refid="cover-test.classpath"/>
</junit>
</target>

<!-- create the html reports -->
<target name="coverage-report" depends="cover-test">
<cobertura-report srcdir="${dir.src}" destdir="cobertura"/>
</target>
</project>

```

See also: [Test Coverage](#)

Testing Web Applications

This page last changed on Dec 11, 2006 by [fr33m3n](#).

This page discusses how to use NekoHTML, HtmlUnit, Watij and WebTest to test web applications. There are many ways to test Web Applications with Groovy:

- use Groovy (potentially in conjunction with a specialist HTML parser) to parse HTML pages as if they were XML
- use Groovy to simplify the code required to drive a Java API browser simulator, e.g. HtmlUnit or HttpUnit
- use Groovy to simplify the code required to drive a Java API for manually driving a real browser, e.g. IE or Firefox
- use Groovy to interact with a higher-level testing library which uses one of the above two approaches, e.g. Watij (for the equivalent of Watir in the Ruby world) or WebTest (to open up the possibility of testing more than just web applications)

We examine a few approaches below.

Groovy with CyberNeko HTML Parser

[NekoHTML](#) is a library which allows you to parse HTML documents (which may not be well-formed) and treat them as XML documents (i.e. XHTML). NekoHTML automatically inserts missing closing tags and does various other things to clean up the HTML if required - just as browsers do - and then makes the result available for use by normal XML parsing techniques.

Here is an example of using NekoHTML with XmlParser to find '.html' hyperlinks on the groovy homepage:

```
def parser = new org.cyberneko.html.parsers.SAXParser()
parser.setFeature('http://xml.org/sax/features/namespaces', false)
def page = new XmlParser(parser).parse('http://groovy.codehaus.org/')
def data = page.depthFirst().A.'@href'.grep{ it != null && it.endsWith('.html') }
data.each { println it }
```

We turned off namespace processing which lets us select nodes using '.A' with no namespace.

Here is one way to do the same example with XmlSlurper:

```
def page = new XmlSlurper(new org.cyberneko.html.parsers.SAXParser()).parse('http://groovy.codehaus.org/')
def data = page.depthFirst().grep{ it.name() == 'A' && it.@href.toString().endsWith('.html') }. '@href'
data.each { println it }
```

We didn't turn off namespace processing but do the selection using just the local name, i.e. '.name()'

Here is the output in both cases:

```
http://groovy.codehaus.org/apidocs/index.html
/faq.html
/groovy-jdk.html
http://groovy.codehaus.org/team-list.html
http://groovy.codehaus.org/xref/index.html
http://www.javamagazin.de/itr/ausgaben/psecom,id,317,nodeid,20.html
http://www.weiqigao.com/blog/2006/09/14/gruby_on_grails_tonight_at_630.html
http://www.oreillynet.com/onjava/blog/2006/09/charles_nutter_responds_our_fu.html
```

Now that we have the links we could do various kinds of assertions, e.g. check the number of links, check that a particular link was always on the page, or check that there are no broken links.

Groovy and HtmlUnit

The following example tests the Google search engine using [HtmlUnit](#):

```
import com.gargoylesoftware.htmlunit.WebClient
```



```

def webClient = new WebClient()
def page = webClient.getPage('http://www.google.com')
// check page title
assert 'Google' == page.titleText
// fill in form and submit it
def form = page.getFormByName('f')
def field = form.getInputByName('q')
field.setValueAttribute('Groovy')
def button = form.getInputByName('btnG')
def result = button.click()
// check groovy home page appears in list (assumes it's on page 1)
assert result.anchors.any{ a -> a.hrefAttribute == 'http://groovy.codehaus.org/' }

```

Groovy and Watij

The following example tests the Google search engine using [Watij](#):

```

import watij.runtime.ie.IE
import watij.finders.SymbolFactory

def ie = new IE()
ie.start('http://www.google.com')
// check page title
assert ie.title() == 'Google'
// fill in query form and submit it
ie.textField(SymbolFactory.@name, 'q').set('Groovy')
ie.button(SymbolFactory.@name, 'btnG').click()
// check groovy home page appears in list by trying to flash() it
ie.link(SymbolFactory.url, 'http://groovy.codehaus.org/').flash()
ie.close()

```

You can use Watij from within groovysh or groovyconsole if you want to have an interactive (irb-like in ruby terms) experience.

Groovy and WebTest

The following example tests the Google search engine using [WebTest](#):

```

<webtest name="google test">
<steps>
<invoke url="http://google.com"/>
<verifyTitle text="Google"/>
<setInputField name="q" value="Groovy"/>
<clickButton name="btnG"/>
<verifyXPath xpath="//a[@href='http://groovy.codehaus.org/']" />
</steps>
</webtest>

```

The above fragment can be inserted into any [Ant](#) build script where we have defined the WebTest tasks.

The above example didn't use any Groovy but we could have just as easily used some Groovy for the last line if we didn't like the XPath expression, for example:

```

<webtest name="google test">
<steps>
<invoke url="http://google.com"/>
<verifyTitle text="Google"/>
<setInputField name="q" value="Groovy"/>
<clickButton name="btnG"/>
<groovy>
assert step.context.currentResponse.anchors.any{ a -> a.hrefAttribute == 'http://
groovy.codehaus.org/' }
</groovy>
</steps>

```

</webtest>

Depending on your setup, you could produce the following report for this test:

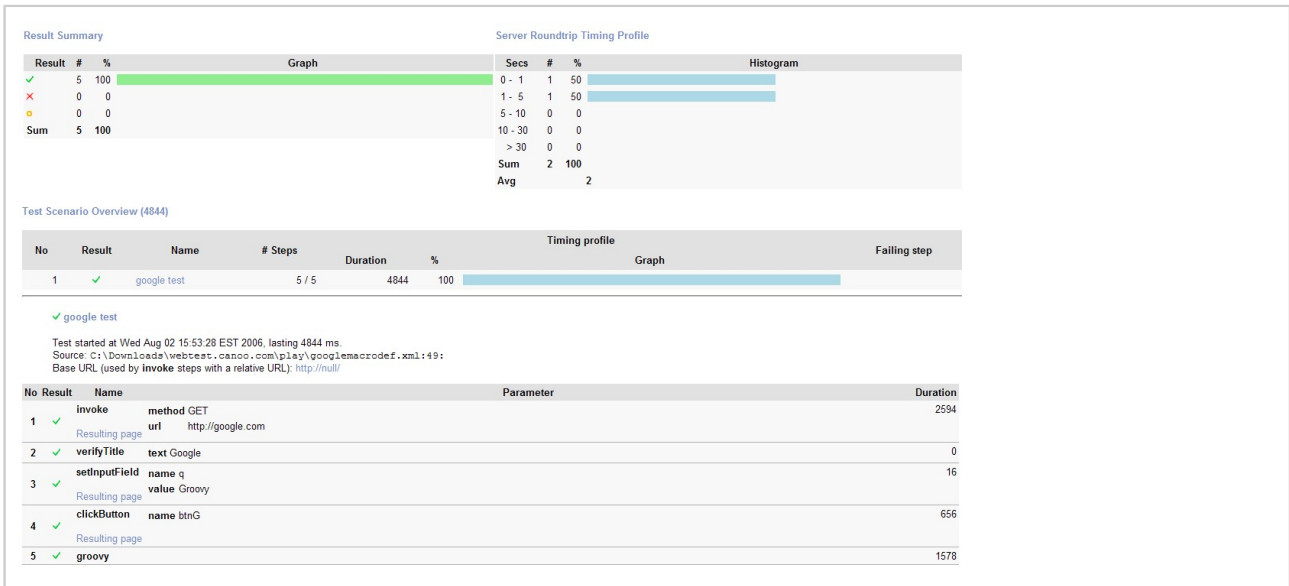

Alternatively, we could have written the whole test in Groovy using AntBuilder as follows:

```
def webtest_home = System.properties.'webtest.home'  
def ant = new AntBuilder()  
  
ant.taskdef(resource: 'webtest.taskdef') {  
  classpath() {  
    pathelement(location: "$webtest_home/lib")  
    fileset(dir: "$webtest_home/lib", includes: "**/*.jar")  
  }  
}  
  
ant.webtest(name: 'Test Google with Groovy, AntBuilder and WebTest') {  
  steps() {  
    invoke(url: 'http://www.google.com')  
    verifyTitle(text: 'Google')  
    setInputField(name: 'q', value: 'Groovy')  
    clickButton(name: 'btnG')  
    verifyXPath(xpath: "//a[@href='http://groovy.codehaus.org/']")  
  }  
}
```

Grails can automatically create this style of test for your generated CRUD applications, see [Grails Functional Testing](#) for more details.

Testing Web Services

This page last changed on Sep 27, 2006 by [paulk_asert](#).

This page discusses how to test Web Services using Groovy directly and in conjunction with WebTest and SoapUI.

Testing Web Services can be done in several ways. Here are three:

- act like a normal web services client and perform asserts on the returned result
- use [WebTest](#) (with either the XML or Groovy syntax)
- use [SoapUI](#) (for functional and load testing)

We are going to use the Web Service example at:

<http://groovy.codehaus.org/Groovy+SOAP>

Being a client

You can be a normal client web service client and perform asserts on the returned results:

```
import groovy.net.soap.SoapClient

def proxy = new SoapClient("http://localhost:6980/MathServiceInterface?wsdl")

def result = proxy.add(1.0, 2.0)
assert (result == 3.0)

result = proxy.square(3.0)
assert (result == 9.0)
```

Using WebTest

Using the WebTest variations makes sense if you are combining your tests into an acceptance test suite.

Here is how you would test it using traditional WebTest:

```
<steps>
<invoke method="POST" contentFile="addreq.xml" soapAction=""
url="http://localhost:6980/MathServiceInterface"/>
<verifyXPath xpath="//addResponse/out[text()='3.0']"/>
<invoke method="POST" contentFile="squaresreq.xml" soapAction=""
url="http://localhost:6980/MathServiceInterface"/>
<verifyXPath xpath="//squareResponse/out[text()='9.0']"/>
</steps>
```

Where addreq.xml would look something like:

```
<?xml version='1.0' encoding='UTF-8'?>
<soap:Envelope
xmlns:soap="http://schemas.xmlsoap.org/soap/envelope/"
xmlns:xsd="http://www.w3.org/2001/XMLSchema"
xmlns:xsi="http://www.w3.org/2001/XMLSchema-instance">
<soap:Body>
<add xmlns="http://DefaultNamespace">
<in0 xmlns="http://DefaultNamespace">1.0</in0>
<in1>2.0</in1>
</add>
</soap:Body>
</soap:Envelope>
```

and squaresreq.xml would look something like:

```
<?xml version='1.0' encoding='UTF-8'?>
<soap:Envelope
xmlns:soap="http://schemas.xmlsoap.org/soap/envelope/"
```

```

xmlns:xsd="http://www.w3.org/2001/XMLSchema"
xmlns:xsi="http://www.w3.org/2001/XMLSchema-instance">
<soap:Body>
<square xmlns="http://DefaultNamespace">
<in0 xmlns="http://DefaultNamespace">3.0</in0>
</square>
</soap:Body>
</soap:Envelope>

```

Alternatively, testing using groovy within WebTest would look like:

```

<steps>
<groovy>
import groovy.net.soap.SoapClient

def proxy = new SoapClient("http://localhost:6980/MathServiceInterface?wsdl")

def result = proxy.add(1.0, 2.0)
assert (result == 3.0)

result = proxy.square(3.0)
assert (result == 9.0)
</groovy>
</steps>

```

Note: you will need to place the jars mentioned on that page in your webtest lib directory (i.e. groovysoap, stax, jaf and mail jars) when using this variation.

The first approach (traditional webtest) produces more information in the test summary reporting but requires you to do more work (i.e. keep the requests around as XML). It depends if you already have those XML files around for other purposes, e.g. manual testing.

Using SOAPUI

[soapui](#) is a SOAP functional and load testing tool. It can use Groovy steps within its testcases. For further details, see the soapui documentation for the [Groovy Step](#). This step supports data-driven tests, allows control of test execution and allows customised reporting.

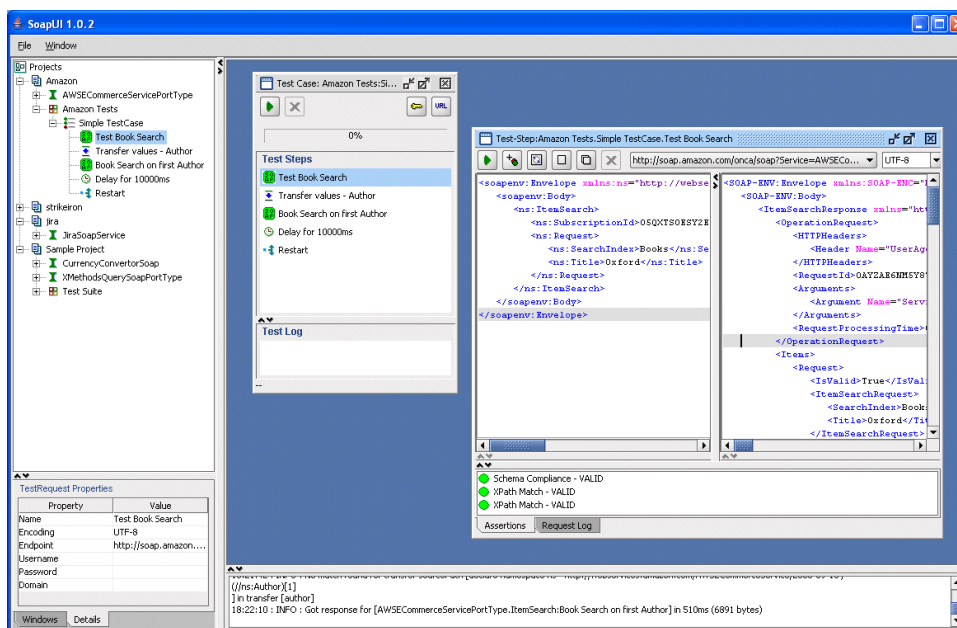

Unit Testing

This page last changed on Sep 25, 2007 by [tomstrummer](#).

The Groovy Advantage

Groovy simplifies JUnit testing, making it more Groovy, in several ways, including:

- JUnit is built into the groovy runtime, so you can script JUnit tests for your Groovy and Java classes using Groovy syntax.
- Groovy provides many additional JUnit assertion statements (see below)
- Groovy unit tests are easily scriptable with Ant / Maven (see below)
- Groovy provides [Groovy Mocks](#)

See also:

- [Unit test your java code with groovy](#)
- [testngroove project page](#)
- [Using JUnit 4 with Groovy](#)

Example

To write unit tests in Groovy, you have to create a class extending `groovy.util.GroovyTestCase`.

```
import groovy.util.GroovyTestCase

class MyTest extends GroovyTestCase {
void testSomething() {
assert 1 == 1
assert 2 + 2 == 4 : "We're in trouble, arithmetic is broken"
}
}
```

Groovy Test Assertions

Apart from the [default assertion methods inherited](#) from the JUnit framework's `TestCase` class, `GroovyTestCase` also offers additional test assertions:

- `assertArrayEquals(Object[] expected, Object[] value)`
- `assertLength(int length, char[] array)`
- `assertLength(int length, int[] array)`
- `assertLength(int length, Object[] array)`
- `assertContains(char expected, char[] array)`
- `assertContains(int expected, int[] array)`
- `assertToString(Object value, String expected)`
- `assertInspect(Object value, String expected)`
- `assertScript(final String script) // assert that a script runs without exceptions`
- `shouldFail(Closure code) // assert that an exception was thrown in that closure`
- `shouldFail(Class clazz, Closure code) // the same but for a class`

Details

By default Groovy unit test cases generate java bytecode and so are just the same as any other Java unit test cases. One thing to watch is often Ant / Maven look for *.java files to find unit tests with pattern matching, rather than *.class files.

There's an option in Maven to ensure you search for classes (and so find any Groovy unit test cases) via this property

```
maven.test.search.classdir = true
```

Once you've got this enabled you can use Maven goals to run individual test cases like this

```
maven test:single -Dtestcase=foo.MyGroovyTest
```

Running GroovyTestCases on the command-line

Since beta-6, you can also run your groovy tests (extending GroovyTestCase) on the command-line. It has simple as launching any other Groovy script or class:

```
groovy MyTest.groovy
```

Running GroovyTestCases in IDEs

Most IDEs support JUnit but maybe don't yet handle Groovy shame! 😊. Firstly if you compile the groovy code to bytecode, then it'll just work in any JUnit IDE just fine.

Sometimes though you want to just hack the unit test script and run from in your IDE without doing a build. If you're IDE doesn't automatically recompile Groovy for you then there's a utility to help you run Groovy unit test cases inside any JUnit IDE without needing to run your Ant / Maven build.

The

[GroovyTestSuite](#)

class is a JUnit TestSuite which will compile and run a GroovyUnit test case from a command line argument (when run as an application) or from the `_test_` system property when run as a JUnit test suite.

To run the GroovyUnitTest as an application, just do the equivalent of this in your IDE

```
java groovy.util.GroovyTestSuite src/test/Foo.groovy
```

Or to run the test suite inside your IDE, just run the GroovyTestSuite test with this system property defined

```
-Dtest=src/test/Foo.groovy
```

Either of the above can really help improve the development experience of writing Groovy unit test cases in IDEs that don't yet support Groovy natively.

Running a TestSuite containing GroovyTestCase scripts directly in Eclipse

You can take advantage of

[GroovyTestSuite](#)

's ability to compile GroovyTestCase scripts into classes to build a TestSuite which can be run from Eclipse's JUnit runner directly.

The suite() method of TestSuite creates and returns a Test. Within your TestSuite's suite() method, you can create a GroovyTestSuite and use to to compile groovy scripts into Class instances, and add them to a TestSuite that you are building using TestSuite.addSuite(Class).

Here's a TestSuite that contains some GroovyTestCase scripts:

```
public class MyTestSuite extends TestSuite {
    // Since Eclipse launches tests relative to the project root,
    // declare the relative path to the test scripts for convenience
    private static final String TEST_ROOT = "test/java/com/foo/bar";
    public static Test suite() throws Exception {
        TestSuite suite = new TestSuite();
        GroovyTestSuite gsuite = new GroovyTestSuite();
        suite.addTestSuite(FooTest.class); // non-groovy test cases welcome, too.
        suite.addTestSuite(gsuite.compile(TEST_ROOT + "BarTest.groovy"));
        suite.addTestSuite(gsuite.compile(TEST_ROOT + "FooFactoryTest.groovy"));
        suite.addTestSuite(gsuite.compile(TEST_ROOT + "BaazTest.groovy"));
        return suite;
    }
}
```

```
}  
}
```

This TestSuite subclass can then be launched as a normal TestSuite in Eclipse. For example, right-click, Run As -> JUnit Test.

From there, the behavior of the JUnit test runner is the same; hierarchy view of all tests and individual methods, their results, etc.

Using normal scripts as unit test cases

You can write scripts like this

```
x = [1, 2, 3]  
assert x.size() == 3
```

and use these scripts as unit test cases if you use the GroovyTestSuite class to run them as described above.

When the above script is compiled, it doesn't actually implement JUnit's TestCase and so needs a special runner so that it can be used inside a JUnit test framework. This is what GroovyTestSuite does, it detects scripts like the above and wraps them in a JUnit Test adapter so you can run scripts like the above as a unit test case inside your IDE.

New AllTestSuite

There is a new class groovy.util.AllTestSuite that transparently cares for all the above.

Simply make a Run Configuration in your IDE for this class, providing the following System Properties:

Property name	meaning	default
groovy.test.dir	the directory to search for groovy tests	./test/
groovy.test.pattern	the ant fileset pattern to search below the dir	**/*Test.groovy

See the API documentation of groovy.util.AllTestSuite for more details.

Here is the run config for JetBrains IDEA:

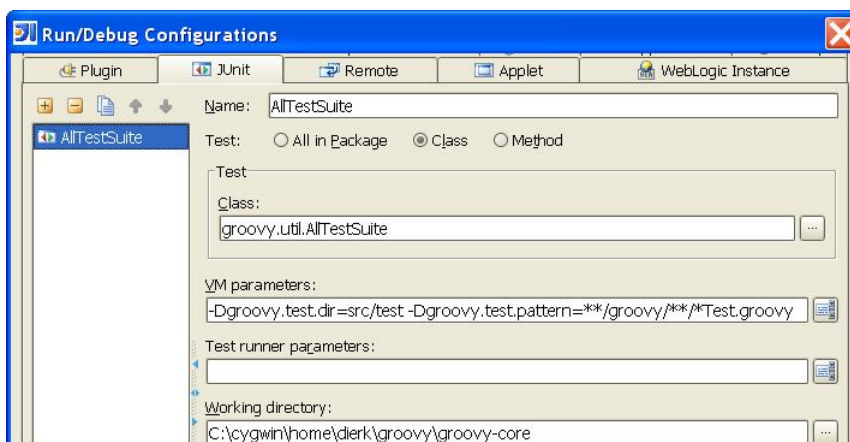

Here is how it looks like when running the AllTestSuite for the the groovy Unit tests of the Groovy project itself:

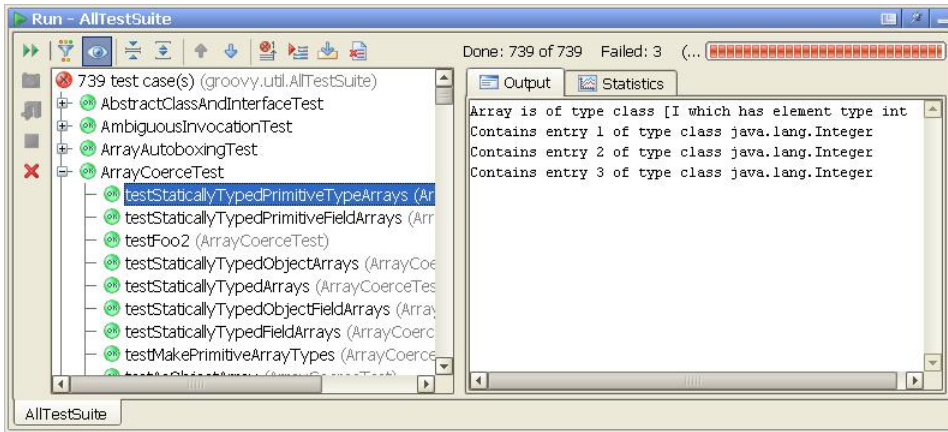

Using JUnit 4 with Groovy

This page last changed on Mar 21, 2008 by [evensonic](#).

Groovy has excellent support for Testing with Unit Testing (GroovyTestCase adds extra capabilities to TestCase from JUnit 3.8.2) and Mocking capabilities built right in. Currently, there are no special Groovy extensions for JUnit 4 but it's easy to use so long as you are using Groovy 1.1 (currently in beta) and Java 5+ (a requirement for annotations/Junit 4.x). Here are some examples.

Make sure you are using Groovy 1.1 (we used beta-2) and JUnit 4.x (we used 4.4).

Simple Example

Let's test some of the built-in arithmetic operators in Groovy.

```
import org.junit.Test
import org.junit.runner.JUnit4
import static org.junit.Assert.assertEquals

class ArithmeticTest {
    @Test
    void additionIsWorking() {
        assertEquals 4, 2+2
    }

    @Test(expected=ArithmeticException)
    void divideByZero() {
        println 1/0
    }
}

JUnit4.main('ArithmeticTest')
```

Our test class includes two tests *additionIsWorking* and *divideByZero*. The second of these is expected to fail with an *ArithmeticException* exception.

Running the test gives:

```
JUnit version 4.4
..
Time: 0.078

OK (2 tests)
```

Hamcrest Matching

You can use the Hamcrest matchers that come with JUnit 4.4 and above like this:

```
import static org.junit.Assert.assertThat
import static org.hamcrest.CoreMatchers.*
import static org.junit.matchers.JUnitMatchers.*
import org.junit.Test
import org.junit.runner.JUnit4

class LanguageTest {
    def languages = [tom:['Java', 'Groovy'], dick:['C#', 'Ruby']]

    @Test void tomKnowsJavaAndGroovyHamcrest() {
        assertThat languages['tom'], is(["Java", "Groovy"])
        assertThat languages['tom'][0], containsString("v")
        assertThat languages['tom'][1], containsString("v")
    }

    @Test void tomKnowsJavaAndGroovyNative() {
        assert languages['tom'] == ["Java", "Groovy"]
        assert languages['tom'].every{ it.contains("v") }
    }
}
```

```
}  
}
```

```
JUnitCore.main(LanguageTest.name)
```

The first test uses the matchers. You can see by the second test, that native Groovy assertions are usually going to do the job just as well if not better in the Groovy world.

Parameterized Testing

JUnit 4.x includes the ability to have parameterized tests. Suppose we want to test the following program:

```
class GroovyMultiplier {  
  int triple(int val) {  
    return val * 3  
  }  
}
```

Here is what your code might look like. This example uses parameterization.

```
import org.junit.Test  
import org.junit.Before  
import org.junit.runner.RunWith  
import org.junit.runner.JUnit4  
import org.junit.runners.Parameterized  
import org.junit.runners.Parameterized.*  
  
@RunWith(Parameterized.class)  
class GroovyMultiplierTest {  
  def testee  
  def param  
  def expectedResult  
  
  @Parameters static data() {  
    return (2..4).collect{ [it, it * 3] as Integer[] }  
  }  
  
  GroovyMultiplierTest(a, b) {  
    param = a  
    expectedResult = b  
  }  
  
  @Before void setUp() {  
    testee = new GroovyMultiplier()  
  }  
  
  @Test void positivesFixed() {  
    assert testee.triple(1) == 3: "+ve multiplier error"  
  }  
  
  @Test void positivesParameterized() {  
    assert testee.triple(param) == expectedResult  
  }  
  
  @Test void negativesParameterized() {  
    assert testee.triple(-param) == -expectedResult  
  }  
}
```

```
JUnitCore.main('GroovyMultiplierTest')
```

The output will look something like this:

```
JUnit version 4.4  
.....
```

Time: 0.062

OK (9 tests)

Theory Tests

You can use the experimental Theory tests from JUnit 4.4 and above as follows:

```
import org.junit.runner.*
import org.junit.experimental.theories.*
import static org.junit.Assume.assumeTrue as assume

@RunWith(Theories)
class LanguageTheoryTest {
  @DataPoint public static String java = 'Java'
  @DataPoint public static String ruby = 'JRuby'
  @DataPoint public static String python = 'Jython'
  @DataPoint public static String javascript = 'Rhino'
  @DataPoint public static String groovy = 'Groovy'
  @DataPoint public static String scala = 'Scala'
  @DataPoint public static String csharp = 'C#'

  def jvmLanguages = [java, ruby, python, groovy, scala, javascript]

  def teamSkills = [
    tom: [java, groovy, ruby],
    dick: [csharp, scala, java, python],
    harry: [javascript, groovy, java]
  ]

  @Theory void everyone_knows_java() {
    teamSkills.each { person, skills ->
      assert java in skills
    }
  }

  @Theory void someone_knows_each_jvm_language(String language) {
    assume language in jvmLanguages
    assert teamSkills.any { person, skills ->
      language in skills
    }
  }

  @Theory void tom_knows_all_languages_ending_with_y(String language) {
    assume language.endsWith('y')
    assert language in teamSkills.tom
  }
}

JUnitCore.main(LanguageTheoryTest.name)
```

When run, this gives:

```
JUnit version 4.4
...
Time: 0.063

OK (3 tests)
```

Using Other Testing Frameworks

This page last changed on Sep 25, 2007 by [tomstrummer](#).

Using Other Java Testing Frameworks

Sometimes you may wish to consider complementing Groovy's built-in capabilities with one or more of the following frameworks:

- [Using EasyMock with Groovy](#)
- [Using Instinct with Groovy](#)
- [Using JBehave with Groovy](#)
- [Using JDummy with Groovy](#)
- [Using JMock with Groovy](#)
- [Using JMockit with Groovy](#)
- [Using Popper with Groovy](#)
- [Using RMock with Groovy](#)
- [Using TestNG with Groovy](#)

Using EasyMock with Groovy

This page last changed on Sep 25, 2007 by [tomstrummer](#).

[EasyMock](#) is a mocking framework for Java. Here we look at EasyMock 2.2 which requires Java 5 and has the following benefits:

- Hand-writing classes for Mock Objects is not needed.
- Supports refactoring-safe Mock Objects: test code will not break at runtime when renaming methods or reordering method parameters
- Supports return values and exceptions.
- Supports checking the order of method calls, for one or more Mock Objects.

The sections below illustrate using EasyMock for the mocking parts of [Using Testing Frameworks with Groovy](#).

The Item Storer Example

We are going to consider how you might use EasyMock as part of testing the [Item Storer Example](#).

Here is how we can test `JavaStorer`:

```
// require(groupId:'easymock', artifactId:'easymock', version='2.2')
import org.easymock.EasyMock

mockControl = EasyMock.createStrictControl()
mockReverser = mockControl.createMock(Reverser.class)
storer = new JavaStorer(mockReverser)
testStorage()

def testStorage() {
    expectReverse(123.456, -123.456)
    expectReverse('hello', 'olleh')
    mockControl.replay()
    checkReverse(123.456, -123.456)
    checkReverse('hello', 'olleh')
    mockControl.verify()
}

def expectReverse(input, output) {
    // it's a pity mockControl doesn't have an expect() method
    EasyMock.expect(mockReverser.reverse(input)).andReturn(output)
}

def checkReverse(value, reverseValue) {
    storer.put(value)
    assert value == storer.get()
    assert reverseValue == storer.getReverse()
}
```

Using Instinct with Groovy

This page last changed on Oct 20, 2007 by [paulk_asert](#).

[Instinct](#) is a Behaviour Driven Development (BDD) framework for Java. Inspired by [RSpec](#), Instinct provides:

- flexible annotation of contexts, specifications, test actors, etc. (via Java 1.5 annotations, marker interfaces or naming conventions)
- automatic creation of test doubles (dummies, mocks and stubs) and test subjects
- state and behavioural (mocks) expectation API
- JUnit test runner integration
- Ant tasks

The sections below illustrate using Instinct for the examples from [Using Testing Frameworks with Groovy](#).

The Stack Example

Here is how you might use Instinct to test the [Stack Example](#):

```
// require(url:'http://code.google.com/p/instinct', jar:'instinct-0.1.5.jar')
// require(url:'http://geekscape.org/static/boost.html', jar:'boost-982.jar')
// require(groupId:'org.jmock', artifactId:'jmock', version:'2.2.0')
import com.googlecode.instinct.marker.annotate.*
import com.googlecode.instinct.runner.TextRunner

class AlmostEmptyFixedStackContext {
private stack

@BeforeSpecification
void initially() {
stack = new FixedStack()
stack.push 'anything'
assert !stack.isEmpty()
}

@Specification
void shouldRemainNotEmptyAfterPeek() {
stack.peek()
assert !stack.isEmpty()
}

@Specification
void shouldBecomeEmptyAfterPop() {
stack.pop()
assert stack.isEmpty()
}
}

class AlmostFullFixedStackContext {
private stack

@BeforeSpecification
void initially() {
stack = new FixedStack()
(1..FixedStack.MAXSIZE).each{ x -> stack.push x }
assert !stack.isFull()
}

@Specification
void shouldBecomeFullAfterPush() {
stack.push 'anything'
assert stack.isFull()
}
}
```

```

class EmptyFixedStackContext extends GroovyTestCase {
private stack = new FixedStack()

@BeforeSpecification
void preConditions() {
assert stack.isEmpty()
}

@Specification
void shouldNoLongerBeEmptyAfterPush() {
stack.push 'anything'
assert !stack.isEmpty()
}

@Specification
void shouldComplainWhenSentPeek() {
shouldFail(StackUnderflowException) {
stack.peek()
}
}

@Specification
void shouldComplainWhenSentPop() {
shouldFail(StackUnderflowException) {
stack.pop()
}
}
}

class FullFixedStackContext extends GroovyTestCase {
private stack

@BeforeSpecification
void initially() {
stack = new FixedStack()
(1..FixedStack.MAXSIZE).each{ x -> stack.push x }
assert stack.isFull()
}

@Specification
void shouldRemainFullAfterPeek() {
stack.peek()
assert stack.isFull()
}

@Specification
void shouldNoLongerBeFullAfterPop() {
stack.pop()
assert !stack.isFull()
}

@Specification
void shouldComplainOnPush() {
shouldFail(StackOverflowException) {
stack.push 'anything'
}
}
}

class NonEmptyFixedStackContext {
private stack

@BeforeSpecification
void setUp() {
stack = new FixedStack()
('a'..'c').each{ x -> stack.push x }
}
}

```

```

assert !stack.isEmpty()
}

@Specification
void shouldAddToTheTopWhenSentPush() {
stack.push 'd'
assert stack.peek() == 'd'
}

@Specification
void shouldBeUnchangedWhenSentPushThenPop() {
stack.push 'anything'
stack.pop()
assert stack.peek() == 'c'
}

@Specification
void shouldReturnTheTopItemWhenSentPeek() {
assert stack.peek() == 'c'
}

@Specification
void shouldNotRemoveTheTopItemWhenSentPeek() {
assert stack.peek() == 'c'
assert stack.peek() == 'c'
}

@Specification
void shouldReturnTheTopItemWhenSentPop() {
assert stack.pop() == 'c'
}

@Specification
void shouldRemoveTheTopItemWhenSentPop() {
assert stack.pop() == 'c'
assert stack.pop() == 'b'
}
}

TextRunner.runContexts(
AlmostEmptyFixedStackContext,
AlmostFullFixedStackContext,
EmptyFixedStackContext,
FullFixedStackContext,
NonEmptyFixedStackContext
)

```

which outputs:

```

AlmostEmptyFixedStackContext
- shouldBecomeEmptyAfterPop
- shouldRemainNotEmptyAfterPeek
AlmostFullFixedStackContext
- shouldBecomeFullAfterPush
EmptyFixedStackContext
- shouldComplainWhenSentPeek
- shouldNoLongerBeEmptyAfterPush
- shouldComplainWhenSentPop
FullFixedStackContext
- shouldComplainOnPush
- shouldNoLongerBeFullAfterPop
- shouldRemainFullAfterPeek
NonEmptyFixedStackContext
- shouldAddToTheTopWhenSentPush
- shouldBeUnchangedWhenSentPushThenPop
- shouldReturnTheTopItemWhenSentPop

```

- shouldReturnTheTopItemWhenSentPeek
- shouldNotRemoveTheTopItemWhenSentPeek
- shouldRemoveTheTopItemWhenSentPop

The Item Storer Example

Here is how you might use Instinct to integration test the [Item Storer Example](#):

```
// require(url:'http://code.google.com/p/instinct', jar:'instinct-0.1.5.jar')
// require(url:'http://geekscape.org/static/boost.html', jar:'boost-982.jar')
// require(groupId:'org.jmock', artifactId:'jmock', version:'2.2.0')
import com.googlecode.instinct.marker.annotate.BeforeSpecification as initially
import com.googlecode.instinct.marker.annotate.Specification as spec
import static com.googlecode.instinct.runner.TextRunner.runContexts as check_specs_for

class a_default_storer {
def storer

@initially void create_new_storer() {
storer = new Storer()
}

private check_persist_and_reverse(value, expectedReverse) {
storer.put(value)

def persisted = storer.get()
assert persisted == value

def reversed = storer.reverse
assert reversed == expectedReverse
}

@spec def should_reverse_numbers() {
check_persist_and_reverse 123.456, -123.456
}

@spec def should_reverse_strings() {
check_persist_and_reverse 'hello', 'olleh'
}

@spec def should_reverse_lists() {
check_persist_and_reverse([1, 3, 5], [5, 3, 1])
}
}

check_specs_for a_default_storer
```

We have used some BDD-flavoured method naming conventions here, but they are not compulsory. Here is the output:

```
a_default_storer
- should_reverse_lists
- should_reverse_strings
- should_reverse_numbers
```

Using JBehave with Groovy

This page last changed on Sep 25, 2007 by [tomstrummer](#).

[JBehave](#) is a Behaviour Driven Development ([BDD](#)) framework for Java.

The sections below illustrate using JBehave for the examples from [Using Testing Frameworks with Groovy](#).

The Stack Example

Here is how you might use JBehave to test the [Stack Example](#):

```
// require(url:'http://jbehave.org/', jar='jbehave-1.0.1.jar')
import org.jbehave.core.Run
import org.jbehave.core.behaviour.Behaviours

class AlmostEmptyFixedStackBehavior {
private stack

void setUp() {
stack = new FixedStack()
stack.push 'anything'
assert !stack.isEmpty()
}

void shouldRemainNotEmptyAfterPeek() {
stack.peek()
assert !stack.isEmpty()
}

void shouldBecomeEmptyAfterPop() {
stack.pop()
assert stack.isEmpty()
}
}

class AlmostFullFixedStackBehavior {
private stack

void setUp() {
stack = new FixedStack()
(1..<FixedStack.MAXSIZE).each{ x -> stack.push x }
assert !stack.isFull()
}

void shouldBecomeFullAfterPush() {
stack.push 'anything'
assert stack.isFull()
}
}

class EmptyFixedStackBehavior extends GroovyTestCase {
private stack = new FixedStack()

void shouldInitiallyBeEmpty() {
assert stack.isEmpty()
}

void shouldNoLongerBeEmptyAfterPush() {
stack.push 'anything'
assert !stack.isEmpty()
}

void shouldComplainWhenSentPeek() {
shouldFail(StackUnderflowException) {
```

```

stack.peek()
}
}

void shouldComplainWhenSentPop() {
shouldFail(StackUnderflowException) {
stack.pop()
}
}
}

class FullFixedStackBehavior extends GroovyTestCase {
private stack

void setUp() {
stack = new FixedStack()
(1..FixedStack.MAXSIZE).each{ x -> stack.push x }
assert stack.isFull()
}

void shouldRemainFullAfterPeek() {
stack.peek()
assert stack.isFull()
}

void shouldNoLongerBeFullAfterPop() {
stack.pop()
assert !stack.isFull()
}

void shouldComplainOnPush() {
shouldFail(StackOverflowException) {
stack.push 'anything'
}
}
}

class NonEmptyFixedStackBehavior {
private stack

void setUp() {
stack = new FixedStack()
('a'..'c').each{ x -> stack.push x }
assert !stack.isEmpty()
}

void shouldAddToTheTopWhenSentPush() {
stack.push 'd'
assert stack.peek() == 'd'
}

void shouldBeUnchangedWhenSentPushThenPop() {
stack.push 'anything'
stack.pop()
assert stack.peek() == 'c'
}

void shouldReturnTheTopItemWhenSentPeek() {
assert stack.peek() == 'c'
}

void shouldNotRemoveTheTopItemWhenSentPeek() {
assert stack.peek() == 'c'
assert stack.peek() == 'c'
}
}

```

```

void shouldReturnTheTopItemWhenSentPop() {
    assert stack.pop() == 'c'
}

void shouldRemoveTheTopItemWhenSentPop() {
    assert stack.pop() == 'c'
    assert stack.pop() == 'b'
}

class AllBehaviours implements Behaviours {
    Class[] getBehaviours() {
        return [
            AlmostEmptyFixedStackBehavior,
            AlmostFullFixedStackBehavior,
            EmptyFixedStackBehavior,
            FullFixedStackBehavior,
            NonEmptyFixedStackBehavior
        ]
    }
}

Run.main('AllBehaviours')

```

The Item Storer Example

Here is how you might use JBehave to test the [Item Storer Example](#):

```

// require(url:'http://jbehave.org/', jar='jbehave-1.0.1.jar')
import org.jbehave.core.Run

class JBehaveStorerBehavior {
    def storer = new Storer()

    def static checkPersistAndReverse(cut, value, reverseValue) {
        cut.put(value)
        assert value == cut.get()
        assert reverseValue == cut.getReverse()
    }

    void shouldReverseStrings() {
        checkPersistAndReverse storer, 'hello', 'olleh'
    }

    void shouldReverseNumbers() {
        checkPersistAndReverse storer, 123.456, -123.456
    }

    void shouldReverseLists() {
        checkPersistAndReverse storer, [1, 3, 5], [5, 3, 1]
    }
}

Run.main('JBehaveStorerBehavior')

```

Using JDummy with Groovy

This page last changed on Sep 25, 2007 by [tomstrummer](#).

[JDummy](#) is a thin API which sits above JMock. It allows very succinct expectation setting code when the expectation code would normally involve many stubs.

The sections below illustrate using JDummy for the mocking parts of [Using Testing Frameworks with Groovy](#).

The Item Storer Example

We are going to consider how you might use JDummy as part of testing the [Item Storer Example](#).

Here is how we can test JavaStorer:

```
// require(groupId:'jmock', artifactId:'jmock', version='1.2.0')
// require(groupId:'jmock', artifactId:'jmock-cglib', version='1.2.0')
// require(groupId:'junit', artifactId:'junit', version='3.8.2')
// require(groupId:'cglib', artifactId:'cglib-nodep', version='2.2_beta1')
// require(url:'jdummy.sf.net', jar:'jdummy-1.3.3.jar')
import net.sf.jdummy.JDummyTestCase

class JDummyTest extends JDummyTestCase {
    def mockReverser, storer

    protected void setUp() throws Exception {
        mockReverser = mimicWithDummyValues(Reverser.class)
        storer = new JavaStorer(mockReverser)
    }

    void testStorage() {
        expectReverse(123.456, -123.456)
        expectReverse('hello', 'olleh')
        checkReverse(123.456, -123.456)
        checkReverse('hello', 'olleh')
    }

    def expectReverse(input, output) {
        // with is a keyword in Groovy so we quote it
        assertBehavior(mockReverser).expects(once()).method('reverse').'with'(eq(input)).will(returnValue(output))
    }

    def checkReverse(value, reverseValue) {
        storer.put(value)
        assert value == storer.get()
        assert reverseValue == storer.getReverse()
    }
}

def suite = new junit.framework.TestSuite()
suite.addTestSuite(JDummyTest.class)
junit.textui.TestRunner.run(suite)
```

Note: Our example is so simple, that JDummy's power is not really illustrated here.

Using JMock with Groovy

This page last changed on Sep 25, 2007 by [tomstrummer](#).

[JMock](#) is a popular mocking framework for Java. Several versions are available.

The sections below illustrate using various versions of JMock for the mocking parts of [Using Testing Frameworks with Groovy](#).

The Item Storer Example

We are going to consider how you might use JMock as part of testing the [Item Storer Example](#).

Here is how we can test `JavaStorer` using version 1.x of JMock using its JUnit 3 integration:

```
// require(groupId:'jmock', artifactId:'jmock-core', version='1.2.0')
// require(groupId:'junit', artifactId:'junit', version='3.8.2')
import org.jmock.MockObjectTestCase

class JMock1Test extends MockObjectTestCase {
    def mockControl, mockReverser, storer

    protected void setUp() throws Exception {
        mockControl = mock(Reverser.class)
        mockReverser = mockControl.proxy()
        storer = new JavaStorer(mockReverser)
    }

    void testStorage() {
        expectReverse(123.456, -123.456)
        expectReverse('hello', 'olleh')
        checkReverse(123.456, -123.456)
        checkReverse('hello', 'olleh')
    }

    def expectReverse(input, output) {
        // with is a keyword in Groovy so we quote it
        mockControl.expects(once()).method('reverse').with(eq(input)).will(returnValue(output))
    }

    def checkReverse(value, reverseValue) {
        storer.put(value)
        assert value == storer.get()
        assert reverseValue == storer.getReverse()
    }
}

def suite = new junit.framework.TestSuite()
suite.addTestSuite(JMock1Test.class)
junit.textui.TestRunner.run(suite)
```

Here is how we can test `JavaStorer` using version 2.x of JMock using its JUnit 4 integration:

```
// require(groupId:'junit', artifactId:'junit4', version='4.3.1')
// require(groupId:'org.jmock', artifactId:'jmock', version='2.1.0')
// require(groupId:'org.jmock', artifactId:'jmock-junit4', version='2.1.0')
import org.jmock.integration.junit4.JMock
import org.jmock.Mockery
import org.junit.Test
import org.junit.Before
import org.junit.runner.RunWith
import org.junit.runner.RunWith

@RunWith(JMock)
class JMock2Test {
    Mockery context = new JUnit4GroovyMockery()
```

```

def mockReverser, storer

@Before void setUp() throws Exception {
mockReverser = context.mock(Reverser.class)
storer = new JavaStorer(mockReverser)
}

@Test void testStorage() {
expectReverse(123.456, -123.456)
expectReverse('hello', 'olleh')
checkReverse(123.456, -123.456)
checkReverse('hello', 'olleh')
}

def expectReverse(input, output) {
context.checking{
one(mockReverser).reverse(input); will(returnValue(output))
}
}

def checkReverse(value, reverseValue) {
storer.put(value)
assert value == storer.get()
assert reverseValue == storer.getReverse()
}
}

JUnitCore.main('JMock2Test')

```

To make our tests a little more DSL-like, we used the following helper class with JMock 2:

```

import groovy.lang.Closure;
import org.jmock.Expectations;
import org.jmock.integration.junit4.JUnit4Mockery;

public class JUnit4GroovyMockery extends JUnit4Mockery {
class ClosureExpectations extends Expectations {
void closureInit(Closure cl, Object delegate) {
cl.setDelegate(delegate);
cl.call();
}
}

public void checking(Closure c) {
ClosureExpectations expectations = new ClosureExpectations();
expectations.closureInit(c, expectations);
super.checking(expectations);
}
}

```

Using JMockit with Groovy

This page last changed on Sep 25, 2007 by [tomstrummer](#).

[JMockit](#) is a single class with a small set of static methods, which allow arbitrary methods and constructors of any other class to be replaced by mock implementations at runtime. It has the following features:

- no particular design must be followed by code under test, e.g.:
 - you don't need to have interfaces everywhere
 - you don't need to avoid static method calls
 - you don't need to use dependency injection, i.e. you can have `new SomeClass()` calls throughout your code
 - you don't need to worry about `final` classes
- legacy code can be unit tested without the need for any adaptation

Since JMockit depends on the JVM class redefinition mechanism exposed by `java.lang.instrumentation`, Groovy, JUnit or TestNG tests that use it must be run under a Java SE 5 VM. However, application and test code can still be compiled to older versions of the language.

The sections below illustrate using JMockit for the mocking parts of [Using Testing Frameworks with Groovy](#).

The Item Storer Example

We are going to consider how you might use JMockit as part of testing the [Item Storer Example](#).

First we define the following class in a file called `MockReverser.groovy`:

```
class MockReverser implements Reverser {
private testData = [123.456:-123.456, hello:'olleh']
def reverse(value) { testData[value] }
}
```

We place this in a separate file rather than straight in the same script as the instrumentation classes in the JVM (which JMockit relies upon) don't know about classes compiled in memory by Groovy. They will look for replaced classes on the classpath.

Now, here is how we can test `Storer`:

```
// require(url:'https://jmockit.dev.java.net', jar='jmockit.jar')
// require(url:'https://jmockit.dev.java.net', jar='jmockit-asm2.jar')
// needs to be run with "-javaagent:jmockit.jar"
import mockit.*

def checkReverse(storer, value, reverseValue) {
storer.put(value)
assert value == storer.get()
assert reverseValue == storer.getReverse()
}

Mockit.redefineMethods(GroovyReverser, MockReverser)
def storer = new Storer()
checkReverse(storer, 123.456, -123.456)
checkReverse(storer, 'hello', 'olleh')
```

If you recall from the example, `Storer` does a new `GroovyReverser()` call, so we use `Mockit.redefineMethods()` to replace the original version with our mock version.

Using Popper with Groovy

This page last changed on Sep 25, 2007 by [tomstrummer](#).

[Popper](#) extends [JUnit](#) to allow you to specify *theories*. Theories are assertions about your code's behavior that may be true over (potentially) infinite sets of input values. You might find it useful to pose theories about your Groovy code too.

Example

Let's consider how we might test the following class (example taken from the Popper web site):

```
class Dollar {
  int amount
  Dollar(int amount) { this.amount = amount }
  Dollar times(int value) { amount *= value; return this }
  Dollar divideBy(int value) { amount /= value; return this }
}
```

With traditional JUnit code, we might test it as follows:

```
import org.junit.Test
import org.junit.runner.JUnit4Core

class StandardTest {
  @Test void multiplyThenDivide() {
    assert new Dollar(10).times(6).divideBy(6).amount == 10
  }
}

JUnit4Core.main('StandardTest')
```

This tests the method for one amount value and one m value. Next steps might be to triangulate so that additional values are also tested. In general though, it might be difficult to know when you have done enough values (when to stop) and also what invariants of your class may hold if you simply keep adding more tests without sufficient refactoring. With these factors in mind, Popper provides facilities to make invariants and preconditions of your classes obvious as well as providing an extensible framework for adding new test values.

Here is how you might use Popper to test the above class. First, we have avoided using [Hamcrest](#) style assertions in our Groovy code. Groovy's built-in `assert` method usually allows such assertions to be expressed very elegantly without any additional framework. We'll create a small helper class to allow Groovy-style assertions to be used for method pre-conditions:

```
import static net.saff.theories.assertion.api.Requirements.*
import net.saff.theories.assertion.api.InvalidTheoryParameterException
import net.saff.theories.runner.api.TheoryContainer

class GroovyTheoryContainer extends TheoryContainer {
  def assume(condition) {
    try {
      assert condition
    } catch (AssertionError ae) {
      throw new InvalidTheoryParameterException(condition, is(condition))
    }
  }
  def assumeMayFailForIllegalArguments(Closure c) {
    try {
      c.call()
    } catch (IllegalArgumentException e) {
      throw new InvalidTheoryParameterException(e, isNull())
    }
  }
}
```

Now, our test becomes:

```

import org.junit.*
import org.junit.runner.*
import net.saff.theories.methods.api.Theory
import net.saff.theories.runner.api.*

@RunWith(Theories)
class PopperTest extends GroovyTheoryContainer {
private log = [] // for explanatory purposes only
public static int VAL1 = 0
public static int VAL2 = 1
public static int VAL3 = 2
public static int VAL4 = 5

@Theory void multiplyIsInverseOfDivide(int amount, int m) {
assume m != 0
assert new Dollar(amount).times(m).divideBy(m).amount == amount
log << [amount, m]
}

@After void dumpLog() {
println log
}
}

JUnitCore.main('PopperTest')

```

We have added an additional log variable to this example to explain how Popper works. By default, Popper will use any public fields in our test as test data values VAL1 through VAL4 in our example. It will determine all combinations of the available variables and call the `multiplyIsInverseOfDivide()` for each combination. This is a very crude way to select test instance values but works for simple tests like this one.

You should also note the `assume` statement. In our example, we haven't catered for `m` being 0 which would result in a divide by zero error. The `assume` statement allows this method precondition to be made explicit. When Popper calls the test method, it will silently ignore any test data combinations which fail the method preconditions. This keeps the preconditions obvious and simplifies creating test data sets.

Here is the output from running this test:

```

JUnit version 4.3.1
.[[0, 1], [0, 2], [0, 5], [1, 1], [1, 2], [1, 5], [2, 1], [2, 2], [2, 5], [5, 1], [5, 2], [5, 5]]

Time: 0.297

OK (1 test)

```

We wouldn't normally recommend sending this kind of information to standard out when running your test, but here it is very illustrative. Note that all four test values have been used for the `amount` variable but only three values have been used for `m`. This is exactly what we want here.

Popper supports an extensible framework for specifying more elaborate algorithms for selecting test data. Instead of the public variables, we can define our own parameter supplier. Here is one which supplies data between a `first` value and a `last` value. First the annotation definition (coded in Java):

```

// Java
import net.saff.theories.methods.api.ParametersSuppliedBy;
import java.lang.annotation.*;

@Retention(RetentionPolicy.RUNTIME)
@ParametersSuppliedBy(BetweenSupplier.class)
public @interface Between {
int first();
int last();
}

```

And the backing supplier (coded in Groovy):

```
import net.saff.theories.methods.api.*
import java.util.*

public class BetweenSupplier extends ParameterSupplier {
public List getValues(test, ParameterSignature sig) {
def annotation = sig.supplierAnnotation
annotation.first()..annotation.last()
}
}
```

Now our Groovy test example could become:

```
import org.junit.*
import org.junit.runner.*
import net.saff.theories.methods.api.Theory
import net.saff.theories.runner.api.*

@RunWith(Theories)
class PopperBetweenTest extends GroovyTheoryContainer {
private int test, total // for explanatory purposes only

@Theory void multiplyIsInverseOfDivide(
@Between(first = -4, last = 2) int amount,
@Between(first = -2, last = 5) int m
) {
total++
assume m != 0
assert new Dollar(amount).times(m).divideBy(m).amount == amount
test++
}

@After void dumpLog() {
println "$test tests performed out of $total combinations"
}
}

JUnitCore.main('PopperBetweenTest')
```

When run, this yields:

```
JUnit version 4.3.1
.49 tests performed out of 56 combinations

Time: 0.234

OK (1 test)
```

The supplied test values for the test method are (-4, -2), (-4, -1), (-4, 0), ..., (2, 5). The data where m is equal to 0 will be skipped as soon as the `assume` statement is reached.

Bowling Example

We can also Groovy to make the [bowling example](#) a little more succinct:

```
import net.saff.theories.methods.api.*
import net.saff.theories.runner.api.*
import org.junit.runner.*

@RunWith(Theories.class)
class BowlingTests extends GroovyTheoryContainer {
public static Game STARTING_GAME = new Game()
public static Game NULL_GAME = null

public static Bowl THREE = new Bowl(3)
public static Bowl FOUR = new Bowl(4)
public static Bowl NULL_BOWL = null
```

```

@DataPoint public Bowl oneHundredBowl() { new Bowl(100) }

public static int ONE_HUNDRED = 100
public static int ZERO = 0

@Theory
public void shouldBeTenFramesWithTwoRollsInEach(Game game, Bowl first, Bowl second) {
    assume game && first && second
    assume game.isAtBeginning()
    assume !first.isStrike()
    assume !second.completesSpareAfter(first)
    10.times {
        game.bowl(first)
        game.bowl(second)
    }
    assert game.isGameOver()
}

@Theory
public void maximumPinCountIsTen(Bowl bowl) {
    assume bowl
    assert bowl.pinCount() <= 10
}

@Theory
public void pinCountMatchesConstructorParameter(int pinCount) {
    assumeMayFailForIllegalArguments {
        assert new Bowl(pinCount).pinCount() == pinCount
    }
}

JUnitCore.main('BowlingTests')

```

Using RMock with Groovy

This page last changed on Sep 25, 2007 by [tomstrummer](#).

[RMock](#) is a Java mock object framework typically used with JUnit 3.x. RMock has support for a setup-modify-run-verify workflow when writing JUnit tests. It integrates better with IDE refactoring support than some other popular mocking frameworks and allows designing classes and interfaces in a true test-first fashion.

The sections below illustrate using RMock for the mocking parts of [Using Testing Frameworks with Groovy](#).

The Item Storer Example

We are going to consider how you might use RMock as part of testing the [Item Storer Example](#).

Here is how we can test `JavaStorer`:

```
// require(groupId:'com.agical.rmock', artifactId:'rmock', version='2.0.2')
// require(groupId:'junit', artifactId:'junit', version='3.8.2')
// require(groupId:'cglib', artifactId:'cglib-nodep', version='2.2_beta1')
import com.agical.rmock.extension.junit.RMockTestCase

class RmockTest extends RMockTestCase {
    def mockReverser, storer

    protected void setUp() throws Exception {
        mockReverser = mock(Reverser.class, 'mockReverser')
        storer = new JavaStorer(mockReverser)
    }

    void testStorage() {
        expectReverse(123.456, -123.456)
        expectReverse('hello', 'olleh')
        startVerification()
        checkReverse(123.456, -123.456)
        checkReverse('hello', 'olleh')
    }

    def expectReverse(input, output) {
        mockReverser.reverse(input)
        modify().returnValue(output)
    }

    def checkReverse(value, reverseValue) {
        storer.put(value)
        assert value == storer.get()
        assert reverseValue == storer.getReverse()
    }
}

def suite = new junit.framework.TestSuite()
suite.addTestSuite(RmockTest.class)
junit.textui.TestRunner.run(suite)
```

Using TestNG with Groovy

This page last changed on Sep 25, 2007 by [tomstrummer](#).

[TestNG](#) is a testing framework inspired from JUnit and NUnit but with new functionality to make it more powerful and easier to use. Features include:

- JDK 5 Annotations (JDK 1.4 is also supported with JavaDoc annotations)
- Flexible test configuration
- Support for data-driven testing (with `@DataProvider`)
- Support for parameters
- Allows distribution of tests on slave machines
- Powerful execution model (no more TestSuite)
- Supported by a variety of tools and plug-ins (Eclipse, IDEA, Maven, etc...)
- Embeds BeanShell for further flexibility
- Default JDK functions for runtime and logging (no dependencies)
- Dependent methods for application server testing

TestNG is designed to cover all categories of tests: unit, functional, end-to-end, integration, etc...

The sections below illustrate using TestNG for the examples from [Using Testing Frameworks with Groovy](#).

The Item Storer Example

Here is how you might use TestNG to integration test the [Item Storer Example](#):

```
// require(groupId:'org.testng', artifactId:'testng', version='5.6')
import org.testng.annotations.*
import org.testng.TestNG
import org.testng.TestListenerAdapter

class StorerIntegrationTest {

private storer

@BeforeClass
def setUp() {
storer = new Storer()
}

private checkPersistAndReverse(value, reverseValue) {
storer.put(value)
assert value == storer.get()
assert reverseValue == storer.getReverse()
}

@Test
void shouldPersistAndReverseStrings() {
checkPersistAndReverse 'hello', 'olleh'
}

@Test
void shouldPersistAndReverseNumbers() {
checkPersistAndReverse 123.456, -123.456
}

@Test
void shouldPersistAndReverseLists() {
checkPersistAndReverse([1, 3, 5], [5, 3, 1])
}

def testng = new TestNG()
testng.setTestClasses(StorerIntegrationTest)
testng.addListener(new TestListenerAdapter())
```

```
testng.run()
```

You might also like to consider the special Groovy integration from the [Test'N'Groove](#) project which provides command-line runners and ant tasks for using TestNG with Groovy.

Using Testing Frameworks with Groovy

This page last changed on Sep 25, 2007 by [tomstrummer](#).

Groovy is great for Agile development in general and testing in particular because:

- it has built-in support for the JUnit testing framework
- it has built-in mocking capabilities
- it provides a very expressive language in which to write tests which can utilise Closure syntax and Groovy's other features which support the creation of testing domain specific languages (DSLs)
- it can easily leverage Java testing frameworks and IDE support
- it's built-in AntBuilder support makes it easy to set up integration tests

This page explores testing features of Groovy and some other testing frameworks that you may sometimes wish to use to complement Groovy's built-in capabilities.

Two main examples are used:

- A Stack Example
- An Item Storer Example



Some of the examples on this page rely on annotations: a feature currently available in the Groovy 1.1 snapshot releases when used with Java 5 and above.

A Stack Example

Inspired by the [RSpec](#) stack example, suppose we want to test the following Groovy classes:

```
class StackOverflowException extends RuntimeException {}

class StackUnderflowException extends RuntimeException {}

class FixedStack {
public static MAXSIZE = 10
private items = []

def push(object) {
if (items.size() == MAXSIZE) throw new StackOverflowException()
items << object
}

def pop() {
if (!items) throw new StackUnderflowException()
items.pop()
}

def peek() {
if (!items) throw new StackUnderflowException()
items[-1]
}

boolean isEmpty() {
items.isEmpty()
}

boolean isFull() {
items.size() == MAXSIZE
}
}
```



```
}
```

We can test this with vanilla Groovy using the following tests:

```
class NonEmptyFixedStackTest extends GroovyTestCase {
private stack

void setUp() {
stack = new FixedStack()
["a", "b", "c"].each{ x -> stack.push x }
}

void testPreConditions() {
assert !stack.isEmpty()
}

void testShouldAddToTheTopWhenSentPush() {
stack.push "d"
assert stack.peek() == "d"
}

void testShouldBeUnchangedWhenSentPushThenPop() {
stack.push "anything"
stack.pop()
assert stack.peek() == "c"
}

void testShouldReturnTheTopItemWhenSentPeek() {
assert stack.peek() == "c"
}

void testShouldNotRemoveTheTopItemWhenSentPeek() {
assert stack.peek() == "c"
assert stack.peek() == "c"
}

void testShouldReturnTheTopItemWhenSentPop() {
assert stack.pop() == "c"
}

void testShouldRemoveTheTopItemWhenSentPop() {
assert stack.pop() == "c"
assert stack.pop() == "b"
}
}

class EmptyFixedStackTest extends GroovyTestCase {
private stack = new FixedStack()

void testPreConditions() {
assert stack.isEmpty()
}

void testShouldNoLongerBeEmptyAfterPush() {
stack.push "anything"
assert !stack.isEmpty()
}

void testShouldComplainWhenSentPeek() {
shouldFail(StackUnderflowException) {
stack.peek()
}
}
}
```

```

void testShouldComplainWhenSentPop() {
shouldFail(StackUnderflowException) {
stack.pop()
}
}
}

class FullFixedStackTest extends GroovyTestCase {
private stack

void setUp() {
stack = new FixedStack()
(1..FixedStack.MAXSIZE).each{ x -> stack.push x }
}

void testPreConditions() {
assert stack.isFull()
}

void testShouldRemainFullAfterPeek() {
stack.peek()
assert stack.isFull()
}

void testShouldNoLongerBeFullAfterPop() {
stack.pop()
assert !stack.isFull()
}

void testShouldComplainOnPush() {
shouldFail(StackOverflowException) {
stack.push "anything"
}
}
}

class AlmostFullFixedStackTest extends GroovyTestCase {
private stack

void setUp() {
stack = new FixedStack()
(1..<FixedStack.MAXSIZE).each{ x -> stack.push x }
}

void testPreConditions() {
assert !stack.isFull()
}

void testShouldBecomeFullAfterPush() {
stack.push "anything"
assert stack.isFull()
}
}

class AlmostEmptyFixedStackTest extends GroovyTestCase {
private stack

void setUp() {
stack = new FixedStack()
stack.push "anything"
}

void testPreConditions() {
assert !stack.isEmpty()
}
}

```

```

void testShouldRemainNotEmptyAfterPeek() {
    stack.peek()
    testPreConditions()
}

void testShouldBecomeEmptyAfterPop() {
    stack.pop()
    assert stack.isEmpty()
}
}

```

Of course, even within vanilla Groovy we have a few options. E.g., we could use no test class, just a script, in which case, the naming conventions required by JUnit 3.x (used above) wouldn't apply. Or, we could have used JUnit 4 and annotations to allow us to use alternate naming conventions for the methods. Alternatively, we could use a single test class with different test fixtures, e.g. `fullStack` and `emptyStack`. The other frameworks [mentioned below](#) allow additional possibilities for organising and naming our tests.

An Item Storer Example

Suppose we have the following Java interface (Groovy supports interface-oriented programming as well as dynamic programming using duck-typing and here we want to illustrate Java test/mock libraries later):

```

// Java
public interface Reverser {
    Object reverse(Object item);
}

```

Now suppose we have an implementation method as follows:

```

class GroovyReverser implements Reverser {
    def reverse(item) {
        if (item instanceof Number) return -item
        return item.reverse()
    }
}

```

For numbers, the `reverse()` method will negate them. Thanks to duck-typing, other objects that we try to reverse will just call their respective types `reverse()` method if it exists, e.g. so it will work for `String` and `List` objects.

Now suppose we make use of a reverser in some code we are trying to test.

```

class Storer {
    def stored
    Reverser reverser = new GroovyReverser()
    def put(item) {
        stored = item
    }
    def get() {
        return stored
    }
    def getReverse() {
        return reverser.reverse(stored)
    }
}

```

Integration Testing

We can integration test this class as follows:

```

def checkPersistAndReverse(cut, value, reverseValue) {
    cut.put(value)
    assert value == cut.get()
    assert reverseValue == cut.getReverse()
}

```

```

}

def testBehavior(cut) {
  checkPersistAndReverse cut, 123.456, -123.456
  checkPersistAndReverse cut, 'hello', 'olleh'
  checkPersistAndReverse cut, [1, 3, 5], [5, 3, 1]
}

testBehavior(new Storer())

```

Mocking Groovy Classes

The above integration tests exercise our class under test with the production `reverser` in place. For this particular example, we might argue that such a test is appropriate and sufficient. However, in more complicated scenarios, the dependent collaboration class (`GroovyReverser` in this case) might be difficult or expensive to construct. In those cases, we would want to replace it with a mock or stub. See [Groovy Mocks](#) for a definition of terms.

Here is how we would use Groovy's built-in mock support to test our class under test in isolation:

```

import groovy.mock.interceptor.MockFor

def mockReverser = new MockFor(GroovyReverser.class)
mockReverser.demand.reverse{ arg -> -arg }
mockReverser.demand.reverse{ arg -> arg.reverse() }
mockReverser.use {
  testBehavior(new Storer())
}

```

Note that we didn't need to do anything to inject our mocks into the class under test. Inside the `use` method, all attempts to create a `GroovyReverser` object will be replaced by a mock object. This also works for Java objects created by Groovy objects, as the following shows:

```

mockReverser = new MockFor(JavaReverser.class)
mockReverser.demand.reverse{ arg -> -arg }
mockReverser.demand.reverse{ arg -> arg.reverse() }
mockReverser.use {
  testBehavior(new Storer(reverser:new JavaReverser()))
}

```

Here `JavaReverser` is a class that we have defined as follows:

```

import java.util.List;
import java.util.ArrayList;
import java.util.ListIterator;

public class JavaReverser implements Reverser {
  public Object reverse(Object item) {
    if (item instanceof Number) {
      Number n = (Number) item;
      return new Double(-n.doubleValue());
    }
    if (item instanceof String) {
      String s = (String) item;
      int size = s.length();
      StringBuffer sb = new StringBuffer(size);
      for (int i = size - 1; i >= 0; i--) {
        sb.append(s.charAt(i));
      }
      return sb.toString();
    }
    if (item instanceof List) {
      List l = (List) item;
      int size = l.size();
      List result = new ArrayList(size);
      ListIterator iter = l.listIterator(size);

```

```
while (iter.hasPrevious()) {
    result.add(iter.previous());
}
return result;
}
throw new UnsupportedOperationException();
}
}
```

Hmmm. Quite a bit longer than the Groovy version. But that's another story.

Testing Java classes which use other Java classes

Now, consider now the following Java class:

```
public class JavaStorer {
    Object stored;
    Reverser reverser;

    public JavaStorer(Reverser reverser) {
        this.reverser = reverser;
    }

    void put(Object item) {
        stored = item;
    }
    Object get() {
        return stored;
    }
    Object getReverse() {
        return reverser.reverse(stored);
    }
}
```

We now want to test this too and we want to use Groovy to write the tests. Unfortunately, Groovy's built-in mock support won't help us here. It doesn't allow us to test Java classes like this one as it relies on hooking into Groovy's object lifecycle mechanisms. Instead, we can use any of the available Java mocking packages such as the ones [mentioned here](#).

GSpec

GSpec is a testing framework written in Groovy, which this example is based on. See [this page](#) for a full explanation of using GSpec for BDD style testing.

Using GSpec with Groovy

This page last changed on Apr 21, 2007 by [paulk_asert](#).

[GSpec](#) is an evolving framework to allow you to apply a [BDD](#) style of programming when using Groovy. The sections below illustrate using GSpec for the examples from [Using Testing Frameworks with Groovy](#).

The Stack Example

Here is how you might test the [Stack Example](#) with GSpec:

```
import com.craig.gspec.GSpecBuilderRunner

def the = new GSpecBuilderRunner()

the.context('A non-empty stack') {
  initially {
    the.stack = new FixedStack()
    ('a'..'c').each { x -> the.stack.push x }
    the.stack.should_not_be_empty
  }

  specify('should return the top item when sent #peek') {
    the.stack.peek().should_equal 'c'
  }

  specify('should NOT remove the top item when sent #peek') {
    the.stack.peek().should_equal 'c'
    the.stack.peek().should_equal 'c'
  }

  specify('should be unchanged when sent #push then #pop') {
    the.stack.push 'Anything'
    the.stack.pop()
    the.stack.peek().should_equal 'c'
  }

  specify('should return the top item when sent #pop') {
    the.stack.pop().should_equal 'c'
    the.stack.push 'c' // put it back the way it was
  }

  specify('should remove the top item when sent #pop') {
    the.stack.pop().should_equal 'c'
    the.stack.pop().should_equal 'b'
  }

  specify('should add to the top when sent #push') {
    the.stack.push 'd'
    the.stack.peek().should_equal 'd'
  }

  the.context('An empty stack') {
    initially {
      the.stack = new FixedStack()
      the.stack.should_be_empty
    }

    specify('should no longer be empty after #push') {
      the.stack.push 'anything'
      the.stack.should_not_be_empty
    }

    specify('should complain when sent #peek') {
      // the.stack.peek().should_fail_with StackUnderflowException
    }
  }
}
```

```

}

specify('should complain when sent #pop') {
  //      the.stack.pop().should_fail_with StackUnderflowException
}
}

the.context('A stack with one item') {
  initially {
    the.stack = new FixedStack()
    the.stack.push 'anything'
    the.stack.should_not_be_empty
  }

  specify('should remain not empty after #peek') {
    the.stack.peak()
    the.stack.should_not_be_empty
  }

  specify('should become empty after #pop') {
    the.stack.pop()
    the.stack.should_be_empty
  }
}

the.context('A stack with one item less than capacity') {
  initially {
    the.stack = new FixedStack()
    (1..<FixedStack.MAXSIZE).each { x -> the.stack.push x }
    the.stack.should_not_be_full
  }

  specify('should become full after #push') {
    the.stack.push 'Anything'
    the.stack.should_be_full
  }
}

the.context('A full stack') {
  initially {
    the.stack = new FixedStack()
    (1..FixedStack.MAXSIZE).each { x -> the.stack.push x }
    the.stack.should_be_full
  }

  specify('should remain full after #peek') {
    the.stack.peak()
    the.stack.should_be_full
  }

  specify('should no longer be full after #pop') {
    the.stack.pop()
    the.stack.should_not_be_full
  }

  specify('should complain on #push') {
    //      the.stack.push('Anything').should_fail_with StackOverflowException
  }
}

```

The Item Storer Example

Here is how you might integration test the [Item Storer Example](#) with GSpec:

```
import com.craig.gspec.GSpecBuilderRunner
```

```
def checkPersistAndReverse(storer, orig, reversed){
  storer.put orig
  storer.get().should_equal orig
  storer.getReverse().should_equal reversed
}

def the = new GSpecBuilderRunner()

the.context('A new storer') {
  initially() {
    the.storer = new Storer()
  }
  specify('Should persist and reverse strings') {
    checkPersistAndReverse the.storer, 'hello', 'olleh'
  }
  specify('Should persist and reverse numbers') {
    checkPersistAndReverse the.storer, 123.456, -123.456
  }
  specify('Should persist and reverse lists') {
    checkPersistAndReverse the.storer, [1, 3, 5], [5, 3, 1]
  }
}
```

User Guide

This page last changed on Nov 24, 2007 by paulk_asert.

Welcome to the Groovy User Guide. We hope you find it useful.

The User Guide assumes you have already [downloaded](#) and installed Groovy. See the [Getting Started Guide](#) if this is not the case.

- [Advanced OO](#)
 - [Groovy way to implement interfaces](#)
- [Annotations with Groovy](#)
- [Ant Integration with Groovy](#)
 - [The groovy Ant Task](#)
 - [The groovyc Ant Task](#)
 - [Using Ant from Groovy](#)
 - [Using Ant Libraries with AntBuilder](#)
- [Bean Scripting Framework](#)
- [Bitwise Operations](#)
- [Builders](#)
 - [FactoryBuilderSupport](#)
- [Closures](#)
 - [Closures - Formal Definition](#)
 - [Closures - Informal Guide](#)
- [Collections](#)
- [Control Structures](#)
 - [Logical Branching](#)
 - [Looping](#)
- [Database features](#)
- [Dynamic Groovy](#)
 - [Evaluating the MetaClass runtime](#)
 - [ExpandoMetaClass](#)
 - [ExpandoMetaClass - Borrowing Methods](#)
 - [ExpandoMetaClass - Constructors](#)
 - [ExpandoMetaClass - Dynamic Method Names](#)
 - [ExpandoMetaClass - GroovyObject Methods](#)
 - [ExpandoMetaClass - Interfaces](#)
 - [ExpandoMetaClass - Methods](#)
 - [ExpandoMetaClass - Overriding static invokeMethod](#)
 - [ExpandoMetaClass - Properties](#)
 - [ExpandoMetaClass - Runtime Discovery](#)
 - [ExpandoMetaClass - Static Methods](#)
 - [Per-Instance MetaClass](#)
 - [Using invokeMethod and getProperty](#)
 - [Using methodMissing and propertyMissing](#)
- [GDK Extensions to Object](#)
- [Generics](#)
- [GMaven](#)
 - [GMaven - Advanced Configuration](#)
 - [GMaven - Building Groovy Projects](#)
 - [GMaven - Executing Groovy Code](#)
 - [GMaven - Groovy Runtime](#)
 - [GMaven - Implementing Maven Plugins](#)
 - [GMaven - Releases](#)
 - [GMaven - 1.0-beta-4 Release](#)
 - [GMaven - Running Groovy Tools](#)
- [GPath](#)
- [Groovy and JMX](#)
- [Groovy Categories](#)
- [Groovy CLI](#)
- [Groovy Console](#)
- [Groovy Math](#)
- [Groovy Maven Plugin](#)
- [Groovy Shell](#)
- [Groovy Truth](#)

- [Groovy Utils](#)
 - [ConfigSlurper](#)
 - [ObjectGraphBuilder](#)
 - [ObservableMap](#)
- [GUI Programming with Groovy](#)
 - [Swing Builder](#)
 - [Alphabetical Widgets List](#)
 - [SwingBuilder.borderLayout](#)
 - [SwingBuilder.action](#)
 - [SwingBuilder.actions](#)
 - [SwingBuilder.bind](#)
 - [SwingBuilder.borderLayout](#)
 - [SwingBuilder.boundedRangeModel](#)
 - [SwingBuilder.box](#)
 - [SwingBuilder.boxLayout](#)
 - [SwingBuilder.button](#)
 - [SwingBuilder.buttonGroup](#)
 - [SwingBuilder.cardLayout](#)
 - [SwingBuilder.checkBox](#)
 - [SwingBuilder.checkBoxMenuItem](#)
 - [SwingBuilder.closureColumn](#)
 - [SwingBuilder.colorChooser](#)
 - [SwingBuilder.comboBox](#)
 - [SwingBuilder.compoundBorder](#)
 - [SwingBuilder.container](#)
 - [SwingBuilder.desktopPane](#)
 - [SwingBuilder.dialog](#)
 - [SwingBuilder.editorPane](#)
 - [SwingBuilder.emptyBorder](#)
 - [SwingBuilder.etchedBorder](#)
 - [SwingBuilder.fileChooser](#)
 - [SwingBuilder.flowLayout](#)
 - [SwingBuilder.formattedTextField](#)
 - [SwingBuilder.frame](#)
 - [SwingBuilder.gridBagConstraints](#)
 - [SwingBuilder.gridBagLayout](#)
 - [SwingBuilder.gridLayout](#)
 - [SwingBuilder.imageIcon](#)
 - [SwingBuilder.internalFrame](#)
 - [SwingBuilder.JComponent](#)
 - [SwingBuilder.label](#)
 - [SwingBuilder.layeredPane](#)
 - [SwingBuilder.lineBorder](#)
 - [SwingBuilder.list](#)
 - [SwingBuilder.loweredBevelBorder](#)
 - [SwingBuilder.map](#)
 - [SwingBuilder.matteBorder](#)
 - [SwingBuilder.menu](#)
 - [SwingBuilder.menuBar](#)
 - [SwingBuilder.menuItem](#)
 - [SwingBuilder.optionPane](#)
 - [SwingBuilder.overlayLayout](#)
 - [SwingBuilder.panel](#)
 - [SwingBuilder.passwordField](#)
 - [SwingBuilder.popupMenu](#)
 - [SwingBuilder.progressBar](#)
 - [SwingBuilder.propertyColumn](#)
 - [SwingBuilder.radioButton](#)
 - [SwingBuilder.radioButtonMenuItem](#)
 - [SwingBuilder.raisedBevelBorder](#)
 - [SwingBuilder.raisedEtchedBorder](#)
 - [SwingBuilder.scrollBar](#)
 - [SwingBuilder.scrollPane](#)
 - [SwingBuilder.separator](#)

- [SwingBuilder.slider](#)
- [SwingBuilder.spinner](#)
- [SwingBuilder.spinnerDateModel](#)
- [SwingBuilder.spinnerListModel](#)
- [SwingBuilder.spinnerNumberModel](#)
- [SwingBuilder.splitPane](#)
- [SwingBuilder.springLayout](#)
- [SwingBuilder.tabbedPane](#)
- [SwingBuilder.table](#)
- [SwingBuilder.tableColumn](#)
- [SwingBuilder.tableLayout](#)
- [SwingBuilder.tableModel](#)
- [SwingBuilder.td](#)
- [SwingBuilder.textArea](#)
- [SwingBuilder.textField](#)
- [SwingBuilder.textPane](#)
- [SwingBuilder.titledBorder](#)
- [SwingBuilder.toggleButton](#)
- [SwingBuilder.toolBar](#)
- [SwingBuilder.tr](#)
- [SwingBuilder.tree](#)
- [SwingBuilder.viewport](#)
- [SwingBuilder.widget](#)
- [SwingBuilder.window](#)
- [Categorical Widget List](#)
- [Extending Swing Builder](#)
- [SwingXBuilder](#)
 - [Effects](#)
 - [Extending SwingXBuilder](#)
 - [Graphs](#)
 - [MultiSplitPane](#)
 - [Painters](#)
 - [Widgets and Common Attributes](#)
- [Input Output](#)
- [Integration](#)
- [JSR 223 Scripting with Groovy](#)
- [Logging](#)
- [Migration From Classic to JSR syntax](#)
- [Operators](#)
 - [Operator Overloading](#)
- [Process Management](#)
- [Processing XML](#)
 - [Creating XML using Groovy's MarkupBuilder](#)
 - [Creating XML using Groovy's StreamingMarkupBuilder](#)
 - [Creating XML with Groovy and DOM](#)
 - [Processing XML with XSLT](#)
 - [Reading XML using Groovy's DOMCategory](#)
 - [Reading XML using Groovy's XmlParser](#)
 - [Reading XML using Groovy's XmlSlurper](#)
 - [Reading XML with Groovy and DOM](#)
 - [Reading XML with Groovy and SAX](#)
 - [Reading XML with Groovy and StAX](#)
 - [Reading XML with Groovy and XPath](#)
 - [Updating XML with DOMCategory](#)
 - [Updating XML with XmlParser](#)
 - [Updating XML with XmlSlurper](#)
 - [Using Other XML Libraries](#)
 - [Creating XML with Groovy and DOM4J](#)
 - [Creating XML with Groovy and JDOM](#)
 - [Creating XML with Groovy and XOM](#)
 - [Processing XML with XQuery](#)
 - [Reading XML with Groovy and DOM4J](#)
 - [Reading XML with Groovy and JDOM](#)
 - [Reading XML with Groovy and XOM](#)

- [Validating XML with a DTD](#)
- [Validating XML with a W3C XML Schema](#)
- [Validating XML with RELAX NG](#)
- [XML Example](#)
- [Regular Expressions](#)
- [Reserved Words](#)
- [Running Groovy on .NET 2.0 using IKVM](#)
- [Scoping and the Semantics of "def"](#)
- [Scripts and Classes](#)
- [Statements](#)
- [Static Import Usage](#)
- [Strings](#)
- [Things to remember](#)
- [Things you can do but better leave undone](#)
- [Using Enums](#)
- [Using Spring Factories with Groovy](#)

Advanced OO

This page last changed on May 18, 2007 by [gavingrover](#).

[Implement Interfaces using a Closure or a Map](#)

Groovy way to implement interfaces

This page last changed on Mar 11, 2008 by johnbr@gmail.com.

Groovy provides some very convenient ways to implement interfaces.

Implement interfaces with a closure

An interface with a single method can be implemented with a closure like so:

```
new Thread(  
{println "running"} as Runnable  
)start()
```

You can also use a closure to implement an interface with more than one method. The closure will be invoked for each method on the interface. Since you need a closure whose parameter list matches that of all of the methods you typically will want to use an array as the sole parameter. This can be used just as it is for any Groovy closure and will collect all of the arguments in an array. For example:

```
interface X  
{ void f(); void g(int n); void h(String s, int n); }  
  
x = {Object[] args -> println "method called with $args"} as X  
x.f()  
x.g(1)  
x.h("hello",2)
```

Implement interfaces with a map

More commonly an interface with multiple methods would be implemented with a map like so:

```
impl = [  
i: 10,  
hasNext: { impl.i > 0 },  
next: { impl.i-- },  
]  
iter = impl as Iterator  
while ( iter.hasNext() )  
println iter.next()
```

Note this is a rather contrived example, but illustrates the concept.

You only need to implement those methods that are actually called, but if a method is called that doesn't exist in the map a *NullPointerException* is thrown. For example:

```
interface X  
{ void f(); void g(int n); void h(String s, int n); }  
  
x = [ f: {println "f called"} ] as X  
x.f()  
//x.g()    // NPE here
```

Be careful that you don't accidentally define the map with { }. Can you guess what happens with the following?

```
x = { f: {println "f called"} } as X  
x.f()  
x.g(1)
```

What we've defined here is a closure with a label and a block. Since we've just defined a single closure every method call will invoke the closure. Some languages use { } to define maps so this is an easy mistake until you get used to using [:] to define maps in Groovy.

Note that using the "as" operator as above requires that you have a static reference to the interface you want to implement with a map. If you have a reference to the java.lang.Class object representing the

interface (i.e. do not know or can not hard code the type at script write time) you want to implement, you can use the `asType` method like this:

```
def loggerInterface = Class.forName( 'my.LoggerInterface' )
def logger = [
log : { Object[] params -> println "LOG: ${params[0]}"; if( params.length > 1 )
params[1].printStackTrace() },
close : { println "logger.close called" }
].asType( loggerInterface )
```

See also:

- [Developer Testing using Closures instead of Mocks](#)

Annotations with Groovy

This page last changed on Apr 08, 2008 by [paulk_asert](#).

Introduction

Java 5 and above supports the use of annotations to include metadata within programs. Groovy 1.1 and above also supports such annotations.

Annotations are used to provide information to tools and libraries. They allow a declarative style of providing metadata information and allow it to be stored directly in the source code. Such information would need to otherwise be provided using non-declarative means or using external files. We won't discuss guidelines here for when it is appropriate to use annotations, just give you a quick run down of annotations in Groovy.

Annotations are defined much like Java class files but use the `@interface` keyword. As an example, here is how you could define a `FeatureRequest` Annotation in Java:

```
// Java
public @interface FeatureRequest {
    String key();
    String summary();
    String assignee() default "[unassigned]";
    String status() default "[open]";
    String targetVersion() default "[unassigned]";
}
```

This annotation represents the kind of information you may have in an issue tracking tool. You could use this annotation in a Groovy file as follows:

```
@FeatureRequest(
    key="GROOVY-9999",
    summary="Support Graphical Annotations",
    assignee="Pete",
    status="Open",
    targetVersion="5.0"
)
class SomeClassWhereFeatureCouldBeUsed {
    // ...
}
```

Now if you had tools or libraries which understood this annotation, you could process this source file (or the resulting compiled class file) and perform operations based on this metadata.

As well as defining your own annotations, there are many existing tools, libraries and frameworks that make use of annotations. See some of the examples referred to at the end of this page. As just one example, here is how you could use annotations with Hibernate or JPA:

```
import javax.persistence.*

@Entity
@Table(name="staff")
class Staff implements Serializable {
    @Id @GeneratedValue
    Long id
    String firstname
    String lastname
    String position
}
```

Example

As another example, consider this [XStream](#) example. XStream is a library for serializing Java (and Groovy) objects to XML (and back again if you want). Here is an example of how you could use it without annotations:

```
// require(groupId:'com.thoughtworks.xstream', artifactId:'xstream', version:'1.3')
import com.thoughtworks.xstream.*

class Staff {
String firstname, lastname, position
}

def xstream = new XStream()
def john = new Staff(firstname:'John',
lastname:'Connor',
position:'Resistance Leader')

println xstream.toXML(john)
```

This results in the following output:

```
<Staff>
<firstname>John</firstname>
<lastname>Connor</lastname>
<position>Resistance Leader</position>
</Staff>
```

Just as an aside, not related to annotations, here is how you could write the XML to a file:

```
new File("john.xml").withOutputStream { out ->
xstream.toXML(john, out)
}
```

And how you would read it back in:

```
// require(groupId:'com.thoughtworks.xstream', artifactId:'xstream', version:'1.3')
// require(groupId:'xpp3', artifactId:'xpp3_min', version:'1.1.4c')
import com.thoughtworks.xstream.*

class Staff {
String firstname, lastname, position
}

def xstream = new XStream()
def john
// now read back in
new File("john.xml").withInputStream { ins ->
john = xstream.fromXML(ins)
}

println john.dump()
// => <Staff@12d96f2 firstname=John lastname=Connor position=Resistance Leader>
```

Now, on to the annotations ...

XStream also allows you to have more control over the produced XML (in case you don't like its defaults). This can be done through API calls or with annotations. Here is how we can annotate our Groovy class with XStream annotations to alter the resulting XML:

```
// ...
import com.thoughtworks.xstream.annotations.*

@XStreamAlias("person")
class Associate {
@XStreamAsAttribute
@XStreamAlias('first-name')
String firstname

@XStreamAlias('surname')
String lastname

@XStreamOmitField
```

```
String position
}

msg = new Associate(firstname:'Sarah',
  lastname:'Connor',
  position:'Protector')
Annotations.configureAliases(stream, Associate)
println stream.toXML(msg)
```

When run, this produces the following output:

```
<person first-name="Sarah">
<surname>Connor</surname>
</person>
```

Differences to Java

Annotations may contain lists. When using such annotations with Groovy, remember to use the square bracket list notation supported by Groovy rather than the braces used by Java, i.e.:

```
// Java
@ManagedOperationParameters({
@ManagedOperationParameter(name="x", description="The first number"),
@ManagedOperationParameter(name="y", description="The second number")})
```

Would become:

```
// Groovy
@ManagedOperationParameters([
@ManagedOperationParameter(name="x", description="The first number"),
@ManagedOperationParameter(name="y", description="The second number")])
```

Future Directions

Current work on Groovy annotations has focused on enabling Java annotations to be used with Groovy. Future work may include allowing you to write the annotation definitions themselves in Groovy and also potentially may use annotations within the Groovy language itself or within accompanying tools.

More Examples

Annotations are also used in examples contained within the following pages:

- [Using JUnit 4 with Groovy](#)
- [Using TestNG with Groovy](#)
- [Using Instinct with Groovy](#)
- [Using Popper with Groovy](#)
- [Singleton Pattern](#)
- [Using Spring Factories with Groovy](#)
- [Groovy and JMX](#)

Ant Integration with Groovy

This page last changed on Jun 22, 2007 by [paulk_asert](#).

Introduction

[Ant](#) is the predominant build environment for Java projects. Groovy is a leading Scripting language for the JVM. The good news is that you can use them together easily and with many benefits.

★ **Existing Ant Users (Java Projects):** If you are already familiar with using Ant with a traditional `build.xml` file, then you can continue to do so with almost no changes. If you want you can begin to use the [<groovy>](#) Ant task to bring the full power of a scripting language to your build scripts.

★ **Existing Ant Users (Groovy or mixed Groovy/Java Projects):** If you wish to pre-compile your Groovy scripts as part of your build process (it can help catch syntactic errors earlier if you do) then you need to know about the [<groovyc>](#) Ant task. You will find it almost identical to the `javac` task which you are probably already familiar with.

★ **Existing Groovy Users:** You probably want to consider how you can [use AntBuilder](#) to leverage the many available Ant tasks directly in your code using a DSL-style notation. You can [leverage Ant Libraries](#) in the same way.

Further Information

See also:

- [Ant Task Troubleshooting](#)
- [Ant Manual](#)

A few articles related to this topic:

- [Build scripts with Groovy and Ant](#)
- [Practically Groovy: Ant scripting with Groovy](#)
- [Scripting a Groovy Ant](#)
- [Using Groovy to Send Emails: AntBuilder](#)
- [Using WebTest with AntBuilder](#)

The groovy Ant Task

This page last changed on Oct 19, 2007 by [paulk_asert](#).

<groovy>

Description

Executes a series of Groovy statements. Statements can either be read in from a text file using the *src* attribute or from between the enclosing Groovy tags.

Required taskdef

Assuming *groovy-all-VERSION.jar* is in *my.classpath* you will need to declare this task at some point in the *build.xml* prior to using this task.

```
<taskdef name="groovy"
classname="org.codehaus.groovy.ant.Groovy"
classpathref="my.classpath"/>
```

<groovy> attributes

Attribute	Description	Required
src	File containing Groovy statements. The directory containing the file is added to the classpath	Yes, unless statements enclosed within tags
classpath	the classpath to use	No
classpathref	the classpath to use, given as reference to a PATH defined elsewhere	No

Parameters specified as nested elements

<classpath>

Groovy's classpath attribute is a PATH like structure and can also be set via a nested classpath element.

<arg> (since 1.1)

Arguments can be set via one or more nested <arg> elements using the standard Ant [command line conventions](#).

Available bindings

A number of bindings are in scope for use within your Groovy statements.

Name	Description
ant	an instance of AntBuilder that knows about the current ant project
project	the current ant project

properties	a Map of ant properties
target	the owning target that invoked this groovy script
task	the wrapping task, can access anything needed in org.apache.tools.ant.Task
args	command line arguments, if any

Examples

Hello world, version 1:

```
<groovy>
println "Hello World"
</groovy>
```

Hello world, version 2:

```
<groovy>
ant.echo "Hello World"
</groovy>
```

List all xml files in the current directory:

```
<groovy>
xmlfiles = new File(".").listFiles().findAll{ it =~ "\.xml$" }
xmlfiles.sort().each { println it.toString() }
</groovy>
```

List all xml files within a jar:

```
<zipfileset id="found" src="foobar.jar"
includes="**/*.xml"/>
<groovy>
project.references.found.each {
println it.name
}
</groovy>
```

To run a script:

```
<groovy src="/some/directory/some/file.groovy">
<classpath>
<pathelement location="/my/groovy/classes/directory"/>
</classpath>
</groovy>
```

To find all the 'Builder' classes having an 'org.*' package within a directory of jars:

```
<property name="local.target" value="C:/Projects/GroovyExamples"/>
<groovy>
import java.util.jar.JarFile
def classes = []
def resourceNamePattern = /org\/.*\/.*Builder.class/
def jarNamePattern = /.*(beta|commons).*jar$/

def libdir = new File("${properties['local.target']}/lib")
libdir.listFiles().grep(~jarNamePattern).each { candidate ->
new JarFile(candidate).entries().each { entry ->
if (entry.name =~ resourceNamePattern) classes += entry.name
}
}
properties["builder-classes"] = classes.join(' ')
</groovy>
<echo message='${builder-classes}'/>
```

Which might result in something like:

```
org/apache/commons/cli/PatternOptionBuilder.class org/apache/commons/cli/OptionBuilder.class
org/codehaus/groovy/tools/groovydoc/GroovyRootDocBuilder.class org/custommonkey/xmlunit/
HTMLDocumentBuilder.class org/custommonkey/xmlunit/TolerantSaxDocumentBuilder.class
```

FileScanner version of above (with a slight variation on collecting the names):

```
<groovy>
import java.util.jar.JarFile
def resourceNamePattern = /org\/.*\/.*Builder.class/
def candidates = ant.fileScanner {
fileset(dir: '${local.target}/lib') {
include(name: '*beta*.jar')
include(name: '*commons*.jar')
}
}
def classes = candidates.collect {
new JarFile(it).entries().collect { it.name }.findAll {
it =~~ resourceNamePattern
}
}.flatten()
properties["builder-classes"] = classes.join(' ')
</groovy>
```

Setting arguments

```
<target name="run">
<groovy>
<arg line="1 2 3"/>
<arg value="4 5"/>
println args.size()
println args[2]
args.each{ ant.echo(message:it) }
</groovy>
</target>
```

Buildfile: GROOVY-2087.xml

```
run:
[groovy] 4
[groovy] 3
[echo] 1
[echo] 2
[echo] 3
[echo] 4 5
```

BUILD SUCCESSFUL

More examples

- [Ant, Groovy and the Database](#)

The groovyc Ant Task

This page last changed on Jan 21, 2008 by [russel](#).

<groovyc>

Description

Compiles Groovy source files and, if the joint compilation option is used, Java source files.

Required taskdef

Assuming groovy-all-VERSION.jar is in *my.classpath* you will need to declare this task at some point in the build.xml prior to the groovyc task being invoked.

```
<taskdef name="groovyc"
classname="org.codehaus.groovy.ant.Groovyc"
classpathref="my.classpath"/>
```

<groovyc> Attributes

Attribute	Description	Required
srcdir	Location of the Groovy (and possibly Java) source files.	Yes
destdir	Location to store the class files.	Yes
classpath	The classpath to use.	No
classpathref	The classpath to use given as a path references.	No
sourcepath	The sourcepath to use.	No
sourcepathref	The sourcepath to use given as a path reference.	No
encoding	Encoding of source files.	No
verbose	Asks the compiler for verbose output; defaults to no.	No
includeAntRuntime	Whether to include the Ant run-time libraries in the classpath; defaults to yes.	No
includeJavaRuntime	Whether to include the default run-time libraries from the executing VM in the classpath; defaults to no.	No
fork	Whether to execute groovyc using a spawned instance of the JVM; defaults to no.	No
memoryInitialSize	The initial size of the memory for the underlying VM, if using fork mode; ignored otherwise. Defaults to the standard VM	No

	memory setting. (Examples: 83886080, 81920k, or 80m)	
memoryMaximumSize	The maximum size of the memory for the underlying VM, if using fork mode; ignored otherwise. Defaults to the standard VM memory setting. (Examples: 83886080, 81920k, or 80m)	No
failonerror	Indicates whether compilation errors will fail the build; defaults to true.	No
listfiles	Indicates whether the source files to be compiled will be listed; defaults to no.	No
stacktrace	if true each compile error message will contain a stacktrace	No
jointCompilationOptions	Enable joint compilation, specifying the command line options. (Using a nested javac task is preferred.)	No

Notes: Joint compilation is only available since 1.1-beta-2

<groovyc> Nested Elements

element	kind	Required	Replaces Attribute
src	a path structure	Yes (unless srcdir is used)	srcdir
classpath	a path structure	No	classpath
javac	javac task	No	jointCompilationOptions

Notes:

- For path structures see for example <http://ant.apache.org/manual/using.html#path>
- For usages of the javac task see <http://ant.apache.org/manual/CoreTasks/javac.html>
- The nested javac task behaves more or less as documented for the top-level javac task. srcdir, destdir, classpath, encoding for the nested javac task are taken from the enclosing groovyc task. If these attributes are specified then they are added, they do not replace. In fact, you should not attempt to overwrite the destination. Other attributes and nested elements are unaffected, for example fork, memoryMaximumSize, etc. may be used freely.

Joint Compilation

Joint compilation means that the Groovy compilation will parse the Groovy source files, create stubs for all of them, invoke the Java compiler to compile the stubs along with Java sources, and then continue compilation in the normal Groovy compiler way. This allows mixing of Java and Groovy files without constraint.

To invoke joint compilation with the jointCompilationOptions attribute, you have to simulate the command line with compiler switches. -j enables the joint compilation mode of working. Flags to the Java compiler are presented to the Groovy compiler with the -F option. So, for example, flags like nowarn are specified with -Fnowarn. Options to the Java compiler that take values are presented to the Groovy compiler using

-J options. For example `-Jtarget=1.4 -Jsource=1.4` is used to specify the target level and source level. So a complete `joinCompilationOptions` value may look like: `"-j -Fnowarn -Jtarget=1.4 -J-source=1.4"`. Clearly, using this way of specifying things is a real nuisance and not very Ant-like. In fact there are thoughts to deprecate this way of working and remove it as soon as is practical.

The right way of working is, of course, to use a nested tag and all the attributes and further nested tags as required. It is rare to specify `srcdir` and `destdir`, the nested `javac` task is provided with the `srcdir` and `destdir` values from the enclosing `groovyc` task, and it is invariable the right thing to do just to leave this as is. Here is an example:

```
<groovyc srcdir="${testSourceDirectory}" destdir="${testClassesDirectory}">
<classpath>
<pathelement path="${mainClassesDirectory}"/>
<pathelement path="${testClassesDirectory}"/>
<path refid="testPath"/>
</classpath>
<javac source="1.4" target="1.4" debug="on" />
</groovyc>
```

To restate: the `javac` task gets the `srcdir`, `destdir` and `classpath` from the enclosing `groovyc` task.

Using Ant from Groovy

This page last changed on Jan 17, 2008 by [paulk_asert](#).

If ever you've been working with a build.xml file or some Jelly script and found yourself a little restricted by all those pointy brackets, or found it a bit wierd using XML as a scripting language and wanted something a little cleaner and more straight forward, then maybe Ant scripting with Groovy might be what you're after.

Groovy has a helper class called `AntBuilder` which makes the scripting of Ant tasks really easy; allowing a real scripting language to be used for programming constructs (variables, methods, loops, logical branching, classes etc). It still looks like a neat concise version of Ant's XML without all those pointy brackets; though you can mix and match this markup inside your script. Ant itself is a collection of jar files. By adding them to your classpath, you can easily use them within Groovy as is. We believe using `AntBuilder` leads to more concise and readily understood syntax.

Below are some examples (most taken from Groovy's own `AntBuilder` tests) which demonstrate:

- the use of Ant inside Groovy using the `AntBuilder` DSL notation
- a demo of iterating through an Ant FileSet using `fileScanner`
- that normal variables can be used to pass state into the Ant tasks and that Groovy code can be embedded anywhere in the markup.

```
def ant = new AntBuilder()

// lets just call one task
ant.echo("hello")

// here is an example of a block of Ant inside GroovyMarkup
ant.sequential {
  echo("inside sequential")
  myDir = "target/AntTest/"
  mkdir(dir:myDir)
  copy(todir:myDir) {
    fileset(dir:"src/test") {
      include(name:"**/*.groovy")
    }
  }
  echo("done")
}

// now lets do some normal Groovy again
file = new File("target/AntTest/groovy/util/AntTest.groovy")
assert file.exists()

def ant = new AntBuilder()

// lets create a scanner of filesets
scanner = ant.fileScanner {
  fileset(dir:"src/test") {
    include(name:"**/Ant*.groovy")
  }
}

// now lets iterate over
def found = false
for (f in scanner) {
  println("Found file $f")
  found = true
  assert f instanceof File
  assert f.name.endsWith(".groovy")
}
assert found

def ant = new AntBuilder()

ant.junit {
```

```

test(name:'groovy.util.SomethingThatDoesNotExist')
}

def ant = new AntBuilder()

value = ant.path {
fileset(dir:"xdocs") {
include(name:"*.wiki")
}
}

assert value != null

println "Found path of type ${value.class.name}"
println value

def ant = new AntBuilder()
def taskContainer = ant.parallel(){ // "Parallel" serves as a sample TaskContainer
ant.echo() // "Echo" without message to keep tests silent
}
// not very elegant, but the easiest way to get the ant internals...
assert taskContainer.dump() =~ /nestedTasks=\\[org.apache.tools.ant.taskdefs.Echo@\\w+\\]/

```

Compiling and running a Java file:

```

def ant = new AntBuilder()
ant.echo(file:'Temp.java', '')
class Temp { public static void main(String[] args) { System.out.println("Hello"); }}
''')
ant.javac(srcdir:'.', includes:'Temp.java', fork:'true')
ant.java(classpath:'.', classname:'Temp', fork:'true')
ant.echo('Done')
// =>
// [javac] Compiling 1 source file
// [java] Hello
// [echo] Done

```

Sniffing around ...

```

def ant = new AntBuilder()
Spooftaskcontainer.spoof.length = 0
def PATH = 'task.path'
ant.path(id:PATH){ant.pathelement(location:'classes')}
['spooftaskcontainer':'Spooftaskcontainer', 'spooftask':'Spooftask'].each{ pair ->
ant.taskdef(name:pair.key, classname:'groovy.util.'+pair.value, classpathref:PATH)
}
ant.spoofcontainer(){
ant.spoof()
}
expectedSpooftask =
"Spooftaskcontainer ctor\n"+
"Spooftask ctor\n"+
"in addTask\n"+
"begin Spooftaskcontainer execute\n"+
"begin Spooftask execute\n"+
"end Spooftask execute\n"+
"end Spooftaskcontainer execute\n"
assertEquals expectedSpooftask, Spooftaskcontainer.spoof.toString()

```

Using Ant Libraries with AntBuilder

This page last changed on Oct 16, 2007 by [paulk_asert](#).

Introduction

Recent version of Ant have included a mechanism called [Antlibs](#). These allow you to define your own custom tasks, group them together with the appropriate definitions needed by Ant and use them in your Ant environment without nameclashes. Nameclashes are avoided by using namespaces. Numerous Antlibs are now available from both Apache (the developers of Ant) and other sources. Using these libraries with Groovy is fairly easy - though you have to be careful with some of the details.

AntUnit

The [AntUnit](#) antlib includes predefined `<assert>` tasks corresponding to the most common kind of checks you want to do within your build files. They are using throughout the Ant codebase to test many of the ant tasks but you can use these assertions in your own build files (or any Groovy code) too.

Here is an example the uses the `assertFileDoesntExist` and `assertFileExists` checks.

First, we'll consider the traditional way of incorporating this antlib, by using namespaces (you'll need the `antunit.jar` in your classpath before you begin - as we are relying on Ant's autodiscovery of antlibs mechanism here):

```
def ant = new AntBuilder()

ant.'antlib:org.apache.ant.antunit:assertFileDoesntExist'(file:'copytest1.tmp')
ant.copy(file:'src/antunit.groovy', tofile:'copytest1.tmp')
ant.'antlib:org.apache.ant.antunit:assertFileExists'(file:'copytest1.tmp')
ant.delete(file:'copytest1.tmp')
ant.'antlib:org.apache.ant.antunit:assertFileDoesntExist'(file:'copytest1.tmp')
```

Notice that the `antunit` assertions all exist within their own namespace. That's OK for now, Groovy allows special symbols in method names so long as you include the method name in quotes.

We can also incorporate the antlib directly into the default namespace as follows:

```
import org.apache.tools.ant.taskdefs.Antlib
def ant = new AntBuilder()
def url = this.class.getResource('org/apache/ant/antunit/antlib.xml')
Antlib.createAntlib(ant.antProject, url, 'antlib:org.apache.ant.antunit').execute()

ant.assertFileDoesntExist(file:'copytest1.tmp')
ant.copy(file:'src/antunit.groovy', tofile:'copytest1.tmp')
ant.assertFileExists(file:'copytest1.tmp')
ant.delete(file:'copytest1.tmp')
ant.assertFileDoesntExist(file:'copytest1.tmp')
```

This makes our code look simpler for this example but be careful with this approach though as you need to avoid name clashes. The preferred way is to use the `NamespaceBuilder`. Using this, our code becomes:

```
import groovy.xml.NamespaceBuilder
def ant = new AntBuilder()
def antunit = NamespaceBuilder.newInstance(ant, 'antlib:org.apache.ant.antunit')
def destfile = 'copytest1.tmp'

antunit.assertFileDoesntExist(file:destfile)
ant.copy(file:'src/antunit.groovy', tofile:destfile)
antunit.assertFileExists(file:destfile)
ant.delete(file:destfile)
antunit.assertFileDoesntExist(file:destfile)
```

Maven Ant Tasks

Another useful antlib is the [Maven Ant Tasks](#). They allow you to use Maven's artifact handling features from within Ant including:

- Dependency management - including transitive dependencies, scope recognition and SNAPSHOT handling
- Artifact deployment - file and SSH based deployment to a Maven repository
- POM processing - for reading a Maven 2.0.x pom.xml file

Here is how you could use these tasks to download some required jars into your local maven repository cache (~/.m2 directory).

```
import groovy.xml.NamespaceBuilder
def ant = new AntBuilder()

items = [[groupId:'jfree', artifactId:'jfreechart', version:'1.0.5'],
[groupId:'jfree', artifactId:'jcommon', version:'1.0.9']]

def mvn = NamespaceBuilder.newInstance(ant, 'antlib:org.apache.maven.artifact.ant')

// download artifacts
mvn.dependencies(filesetId:'artifacts') { items.each { dependency(it) } }
// print out what we downloaded
ant.fileScanner { fileset(refid:'artifacts') }.each { println it }
```

When run, this produces a log of the maven ant task activity, such as:

```
Downloading: jfree/jfreechart/1.0.5/jfreechart-1.0.5.pom
...
Transferring 298K
C:\Users\Paul\.m2\repository\jfree\jcommon\1.0.9\jcommon-1.0.9.jar
C:\Users\Paul\.m2\repository\jfree\jfreechart\1.0.5\jfreechart-1.0.5.jar
```

We can take this example further and show how to create the JFreeChart example from [Plotting graphs with JFreeChart](#) without having the JFreeChart jars statically defined in our classpath.

First another helper class:

```
class MavenDependency {
static void require(params) {
MavenDependencyHelper.getInstance().require(params)
}
static MavenDependencyHelper using(classLoader) {
MavenDependencyHelper.getInstance(classLoader)
}
}

private class MavenDependencyHelper {
private classLoader
private MavenDependencyHelper(classLoader) {
this.classLoader = classLoader
}

static MavenDependencyHelper getInstance(classLoader) {
return new MavenDependencyHelper(classLoader)
}

static MavenDependencyHelper getInstance() {
return new MavenDependencyHelper(MavenDependencyHelper.classLoader)
}

MavenDependencyHelper require(params) {
def ant = new AntBuilder()
def mvn = groovy.xml.NamespaceBuilder.newInstance(ant, 'antlib:org.apache.maven.artifact.ant')
mvn.dependencies(filesetId:"artifact_${params.groupId}_${params.artifactId}_${params.version}")
{ dependency(params) }
ant.fileScanner { fileset(refid:"artifact_${params.groupId}_${params.artifactId}_
${params.version}") }.each {
classLoader.addClasspath(it.toString())
}
}
this
```

```
}  
}
```

Now, here is the code we require to dynamically download the JFreeChart jars and add them to our classpath then run the script:

```
// no jfreechart imports required (we'll find them programmatically)  
import groovy.swing.SwingBuilder  
import static javax.swing.WindowConstants.EXIT_ON_CLOSE  
  
def classLoader = Thread.currentThread().contextClassLoader  
  
// load jars and add to classpath  
def maven = MavenDependency.using(classLoader)  
maven.require(groupId:'jfree', artifactId:'jfreechart', version:'1.0.5')  
maven.require(groupId:'jfree', artifactId:'jcommon', version:'1.0.9')  
  
// define used classes/instances programmatically  
def factoryClass = classLoader.loadClass('org.jfree.chart.ChartFactory')  
def orientationClass = classLoader.loadClass('org.jfree.chart.plot.PlotOrientation')  
def dataset = classLoader.loadClass('org.jfree.data.category.DefaultCategoryDataset').newInstance()  
  
// normal code below here  
dataset.addValue 150, "no.1", "Jan"  
dataset.addValue 210, "no.1", "Feb"  
dataset.addValue 390, "no.1", "Mar"  
dataset.addValue 300, "no.2", "Jan"  
dataset.addValue 400, "no.2", "Feb"  
dataset.addValue 200, "no.2", "Mar"  
  
def labels = ["Bugs", "Month", "Count"]  
def options = [true, true, true]  
def chart = factoryClass.createLineChart(*labels, dataset,  
orientationClass.VERTICAL, *options)  
def swing = new SwingBuilder()  
def frame = swing.frame(title:'Groovy LineChart',  
defaultCloseOperation:EXIT_ON_CLOSE) {  
panel(id:'canvas') { rigidArea(width:400, height:400) }  
}  
frame.pack()  
frame.show()  
chart.draw(swing.canvas.graphics, swing.canvas.bounds)
```

Ivy Tasks

We can also download jars using [Ivy](#). In this case we use MarkupBuilder to build an XML file that the Ivy retrieve task will use:

```
import groovy.xml.NamespaceBuilder  
  
def ant = new AntBuilder()  
def ivyfile = 'ivy.xml' // default file used by Ivy  
ant.delete(file:ivyfile, quiet:true)  
  
new File(ivyfile).withWriter { writer ->  
def builder = new groovy.xml.MarkupBuilder(writer)  
builder.'ivy-module'(version:'1.0') {  
info(organisation:"codehaus", module:"GroovyExamples")  
dependencies {  
dependency(org:'jfree', name:'jfreechart', rev:'1.0.5')  
dependency(org:'jfree', name:'jcommon', rev:'1.0.9')  
}  
}  
}  
  
def ivy = NamespaceBuilder.newInstance(ant, 'antlib:org.apache.ivy.ant')
```

```
ivy.retrieve()
ivy.report(toDir:'reports') // optional
```

When run, this results in the files being downloaded:





```
[antlib:org.apache.ivy.ant:retrieve] :: Ivy 2.0.0-alpha-1-incubating - 20070416155158
...
[antlib:org.apache.ivy.ant:retrieve] downloading http://repo1.maven.org/maven2/jfree/
jfreechart/1.0.5/jfreechart-1.0.5.jar
...
[antlib:org.apache.ivy.ant:retrieve] [SUCCESSFUL ] [ jfree | jfreechart | 1.0.5 ]/
jfreechart.jar[jar] (16735ms)
[antlib:org.apache.ivy.ant:retrieve] downloading http://repo1.maven.org/maven2/jfree/jcommon/1.0.9/
jcommon-1.0.9.jar
...
[antlib:org.apache.ivy.ant:retrieve] [SUCCESSFUL ] [ jfree | jcommon | 1.0.9 ]/jcommon.jar[jar]
(6812ms)
[antlib:org.apache.ivy.ant:retrieve] :: resolution report ::
-----
|          conf          |          modules          |          artifacts          |
|          number       | search|dwnlded|evicted| | number|dwnlded|
-----
|          default     | 2 | 2 | 0 | 0 | | 2 | 2 |
-----
[antlib:org.apache.ivy.ant:retrieve] :: retrieving :: [ codehaus | grails ]
[antlib:org.apache.ivy.ant:retrieve]   confs: [default]
[antlib:org.apache.ivy.ant:retrieve]   2 artifacts copied, 0 already retrieved
```

If you included the optional `report` step (and add `ant-trax.jar` from your ant distribution to our classpath), then you would have some additional log information and it would produce the following pretty report on dependencies:



default

Dependencies Stats

Modules	2
Revisions	2 (0 searched  , 0 downloaded  , 0 evicted  , 0 errors )
Artifacts	2 (0 downloaded, 0 failed)
Artifacts size	1456 kB (0 kB downloaded, 1456 kB in cache)

Dependencies Overview

Module	Revision	Status	Resolver	Default	Licenses	Size
jfreechart by jfree	1.0.5	Integration	public	false		1157 kB
... jcommon by jfree	1.0.9	Integration	public	false		299 kB
jcommon by jfree	1.0.9	Integration	public	false		299 kB

Details

jfreechart by jfree resolved by default

Revision: 1.0.5

Status	Integration
Publication	20070607031318
Resolver	public
Configurations	system, default, compile, provided, runtime, master
Artifacts size	1157 kB (0 kB downloaded, 1157 kB in cache)

Required by

Organisation	Name	In Configurations	Asked Revision
codehaus	GroovyExamples	default	1.0.5

Dependencies

Module	Revision	Status	Resolver	Default	Licenses	Size
jcommon by jfree	1.0.9	Integration	public	false		299 kB

Artifacts

Name	Type	Ext	Download	Size
jfreechart	jar	jar	no	1157 kB

jcommon by jfree resolved by default

Revision: 1.0.9

Status	Integration
Publication	20070607031314
Resolver	public
Configurations	system, default, compile, provided, runtime, master
Artifacts size	299 kB (0 kB downloaded, 299 kB in cache)

Required by

Organisation	Name	In Configurations	Asked Revision
jfree	jfreechart	compile, runtime	1.0.9
codehaus	GroovyExamples	default	1.0.9

Dependencies

No dependency

Artifacts

Name	Type	Ext	Download	Size
jcommon	jar	jar	no	299 kB

Bean Scripting Framework

This page last changed on Oct 25, 2006 by [paulk_asert](#).

Groovy integrates cleanly with [BSF](#) (the Bean Scripting Framework) which allows you to embed any scripting engine into your Java code while keeping your Java code decoupled from any particular scripting engine specifics.

The BSF engine for Groovy is implemented by the [GroovyEngine](#) class; however, that fact is normally hidden away by the BSF APIs. You just treat Groovy like any of the other scripting languages via the BSF API.

Note: Groovy has its own native support for integration with Java. See [Embedding Groovy](#) for further details. So you only need to worry about BSF if you want to also be able to call other languages from Java, e.g. [JRuby](#) or if you want to remain very loosely coupled from your scripting language.

Getting started

Provided you have Groovy and BSF jars in your classpath, you can use the following Java code to run a sample Groovy script:

```
String myScript = "println('Hello World')\n return [1, 2, 3]";
BSFManager manager = new BSFManager();
List answer = (List) manager.eval("groovy", "myScript.groovy", 0, 0, myScript);
assertEquals(3, answer.size());
```

Passing in variables

BSF lets you pass beans between Java and your scripting language. You can *register/unregister* beans which makes them known to BSF. You can then use BSF methods to *lookup* beans as required. Alternatively, you can *declare/undeclare* beans. This will register them but also make them available for use directly in your scripting language. This second approach is the normal approach used with Groovy. Here is an example:

```
manager.declareBean("xyz", new Integer(4), Integer.class);
Object answer = manager.eval("groovy", "test.groovy", 0, 0, "xyz + 1");
assertEquals(new Integer(5), answer);
```

Other calling options

The previous examples used the *eval* method. BSF makes multiple methods available for your use (see the [BSF documentation](#) for more details). One of the other available methods is *apply*. It allows you to define an anonymous function in your scripting language and apply that function to arguments. Groovy supports this function using closures. Here is an example:

```
Vector ignoreParamNames = null;
Vector args = new Vector();
args.add(new Integer(2));
args.add(new Integer(5));
args.add(new Integer(1));
Integer actual = (Integer) manager.apply("groovy", "applyTest", 0, 0,
"def summer = { a, b, c -> a * 100 + b * 10 + c }", ignoreParamNames, args);
assertEquals(251, actual.intValue());
```

Access to the scripting engine

Although you don't normally need it, BSF does provide a hook that lets you get directly to the scripting engine. One of the functions which the engine can perform is to invoke a single method call on an object. Here is an example:

```
BSFEngine bsfEngine = manager.loadScriptingEngine("groovy");
manager.declareBean("myvar", "hello", String.class);
Object myvar = manager.lookupBean("myvar");
```

```
String result = (String) bsfEngine.call(myvar, "reverse", new Object[]{});
assertEquals("olleh", result);
```

Legacy points of interest

If you must integrate with early version of BSF (i.e. prior to **bsf 2.3.0-rc2**) then you'll need to manually register the Groovy language with BSF using the following snippet of code:

```
BSFManager.registerScriptingEngine(
    "groovy",
    "org.codehaus.groovy.bsf.GroovyEngine",
    new String[] { "groovy", "gy" }
);
```

Bitwise Operations

This page last changed on Mar 21, 2008 by [renrutal](#).

From Groovy 1.0 beta 10, Groovy supports bitwise operations:
<<, >>, >>>, |, &, ^, and ~.

Operator Symbol	Meaning
<<	Bitwise Left Shift Operator
>>	Bitwise Right Shift Operator
>>>	Bitwise Unsigned Right Shift Operator
	Bitwise Or Operator
&	Bitwise And Operator
^	Bitwise Xor Operator
~	Bitwise Negation Operator
<<=	Bitwise Left Shift Assign Operator
>>=	Bitwise Right Shift Assign Operator
>>>=	Bitwise Unsigned Right Shift Assign Operator
=	Bitwise Or Assign Operator
&=	Bitwise And Assign Operator
^=	Bitwise Xor Operator

For example,

```
assert (1 << 2) == 4           // bitwise left shift
assert (4 >> 1) == 2           // bitwise right shift
assert (15 >>> 1) == 7         // bitwise unsigned right shift
assert (3 | 6) == 7            // bitwise or
assert (3 & 6) == 2            // bitwise and
assert (3 ^ 6) == 5            // bitwise xor
assert (~0xFFFFFFFF) == 1     // bitwise negation
```

Builders

This page last changed on Jul 06, 2007 by [glaforge](#).

Tree Based Syntax

Groovy has special syntax support for List and Maps. This is great because it gives a concise representation of the actual object being defined, so its easier to keep track of what a program or script is doing. But what about programs which contain arbitrary nested tree structures. Surely, they are the hardest ones to keep track of what is going on. Isn't that an area where syntactic help will be most beneficial?

The answer is definitely yes and Groovy comes to the party with its **builder** concept. You can use it for DOM-like APIs or Ant tasks or Jelly tags or Swing widgets or whatever. Each may have their own particular factory mechanism to create the tree of objects - however they can share the same builder syntax to define them - in a concise alternative to XML or lengthy programming code.

Example

[Note: the syntax in some of these examples is slightly out-dated. See chapter 8 of [GINA](#) in the meantime until these examples are updated.]

Here's an example:

```
def f = framesize:[300,300], text:'My Window' {
  labelbounds:[10,10,290,30], text:'Save changes'
  panelbounds:[10,40,290,290] {
    buttontext:'OK', action:{ save close }
    buttontext:'Cancel', action:{ close }
  }
}
```

The above invokes a number of methods on the owner class using named-parameter passing syntax. Then the button method would create JButton etc. The { } is used to define a closure which adds its content to the newly created node. Also notice that the action parameter is passed as a closure - which is ideal for working with UI centric listeners etc.

Note that within the 'markup' you can embed normal expressions - i.e. this markup syntax is a normal part of the Groovy language. e.g.

```
def f = frametext: calculateFieldNamefoo, 1234

// lets iterate through some map
map = [1:"hello", 2:"there"]

for e in map {
  labelname:e.value
  textfieldname:e.value
}
}
```

Using this simple mechanism we can easily create any structured tree of data - or provide an event based model too. Note in Groovy you can just overload the invokeMethodName, arguments to have a simple polymorphic tree creation - such as for DOM is structures or Ant tasks or Jelly tags etc.

Here's an example of some HTML using some mixed content which is typically hard to do neatly in some markup languages

```
html {
  head {
    title"XML encoding with Groovy"
  }
  body {
    h1"XML encoding with Groovy"
    p"this format can be used as an alternative markup to XML"
```

```

/ an element with attributes and text content /
ahref:'http://groovy.codehaus.org' ["Groovy"]

/ mixed content /
p [
  "This is some",
  b"mixed",
  "text. For more see the",
  ahref:'http://groovy.codehaus.org' ["Groovy"],
  "project"
]
p "some text"
}
}

```

Finally here's an example of creating some name-spaced XML structure XSD...

```

def builder = NodeBuilder.newInstance()
def xmlns = new groovy.xml.NamespaceBuilder(builder)

def xsd = xmlns.namespace('http://www.w3.org/2001/XMLSchema', 'xsd')

def root = xsd.schema(xmlns:['foo':'http://someOtherNamespace']) {
  annotation {
    documentation("Purchase order schema for Example.com.")
    //documentation(xmlns=[xml.lang:'en']) ["Purchase order schema for Example.com."]
  }
  element(name:'purchaseOrder', type:'PurchaseOrderType')
  element(name:'comment', type:'xsd:string')
  complexType(name:'PurchaseOrderType') {
    sequence {
      element(name:'shipTo', type:'USAddress')
      element(name:'billTo', type:'USAddress')
      element(minOccurs:'0', ref:'comment')
      element(name:'items', type:'Items')
    }
    attribute(name:'orderDate', type:'xsd:date')
  }
  complexType(name:'USAddress') {
    sequence {
      element(name:'name', type:'xsd:string')
      element(name:'street', type:'xsd:string')
      element(name:'city', type:'xsd:string')
      element(name:'state', type:'xsd:string')
      element(name:'zip', type:'xsd:decimal')
    }
    attribute(fixed:'US', name:'country', type:'xsd:NMTOKEN')
  }
  complexType(name:'Items') {
    sequence {
      element(maxOccurs:'unbounded', minOccurs:'0', name:'item') {
        complexType {
          sequence {
            element(name:'productName', type:'xsd:string')
            element(name:'quantity') {
              simpleType {
                restriction(base:'xsd:positiveInteger') {
                  maxExclusive(value:'100')
                }
              }
            }
          }
        }
        element(name:'USPrice', type:'xsd:decimal')
        element(minOccurs:'0', ref:'comment')
        element(minOccurs:'0', name:'shipDate', type:'xsd:date')
      }
    }
    attribute(name:'partNum', type:'SKU', use:'required')
  }
}

```

```

}
}
}
}
/* Stock Keeping Unit, a code for identifying products */
simpleType(name:'SKU') {
restriction(base:'xsd:string') {
pattern(value:'\\d{3}-[A-Z]{2}')
}
}
}
}

```

There's a converter `org.codehaus.groovy.tools.xml.DomToGroovy` from XML to groovy markup so you can try out this new markup language on any XML documents you have already.

Special cases

To output elements or attributes with a '-' in their name, you need to quote the names. For example, to generate a web-app descriptor for a Servlet app:

```

def builder = new groovy.xml.MarkupBuilder()
builder.'web-app' {
'display-name' 'My Web Application'
}

```

generates:

```

<web-app>
<display-name>My Web Application</display-name>
</web-app>

```

Related links

Andy Glover introduces builders through an [astronomical example](#)

FactoryBuilderSupport

This page last changed on Oct 31, 2007 by [aalmiray](#).

FactoryBuilderSupport

[SwingBuilder](#) is one of the most used Groovy builders. It follows the standard structure of BuilderSupport but uses the concept of factories to build each node. Seeing that the concept was useful enough for other builders the basic implementation was taken out of SwingBuilder and FactoryBuilderSupport was born (and SwingBuilder was retrofitted of course).

The **Factory** interface is the basic building block, the builder will call the factory's methods at specific points during node building, let's see them in their invocation order:

- **Object newInstance(FactoryBuilderSupport builder, Object name, Object value, Map attributes) throws InstantiationException, IllegalAccessException**
Responsible for creating the object that responds to the node 'name' and its called during builder.createNode
- **boolean onHandleNodeAttributes(FactoryBuilderSupport builder, Object node, Map attributes)**
Gives the factory the ability to process the attributes as it may see fit with the option of stopping the builder to process them itself (by returning true).
- **void setParent(FactoryBuilderSupport builder, Object parent, Object child)**
void setChild(FactoryBuilderSupport builder, Object parent, Object child)
allows the factory to setup parent/child relationships.
- **boolean isLeaf()**
Lets the builder know if the node allows for further nodes to be nested on the current node.
- **void onNodeCompleted(FactoryBuilderSupport builder, Object parent, Object node)**
Is the last method called from the factories perspective, it will let you handle any cleanup the node may require.

But that's not everything FactoryBuilderSupport has to offer. The factories may require contextual information on the current node being built to do its work, onNodeCompleted may require information that it is only available when newInstance is invoked, or newInstance may need to inspect the parent to decide what is the best way to create the node, just to mention a few scenarios, that's why FactoryBuilderSupport enables the following helping methods:

Method	Description
Map getContext()	returns the context of the current node
Map getParentContext()	returns the context of the parent of the current node
Factory getCurrentFactory()	returns the factory that built the current node
Factory getParentFactory()	returns the factory of the parent of the current node (if any)
Object getParentNode()	returns the parent of the current node (if any)
Object getCurrent()	returns the current node

The builder is marked as abstract so you are required to create a subclass for your own builders, despite that it doesn't enforce the implementation of any method at all. There are a couple of protected methods though, that when overwritten will give you more control over the builder's internal workings:

- **Factory resolveFactory(Object name, Map attributes, Object value)**
Usually what you would like in a subclass of FactoryBuilderSupport is a **1 to 1** relation on node names to factories, but for those cases where you would like **n to 1** you can override this method and plug in your custom selection mechanism.
- **void preInstantiate(Object name, Map attributes, Object value)**
void postInstantiate(Object name, Map attributes, Object node)

void handleNodeAttributes(Object node, Map attributes)

Object postNodeCompletion(Object parent, Object node)

These methods are called during the lifecycle of a node, you can override them at any time but there is also a way to extend the behavior associated with those calls without overwriting the methods: you may register a closure, in fact as many as you like, to hook your own logic. The closures will be called from last to first as they were registered.

TODO document build() methods

Closures

This page last changed on Mar 18, 2008 by pascal.ch@gmail.com.

What is a Closure?

A Groovy closure is like a "code block" or a method pointer. It is a piece of code that is defined and then executed at a later point.

Simple Example

```
def clos = { println "hello!" }

println "Executing the closure:"
clos() //prints "hello!"
```

Note that in the above example, "hello!" is printed when the closure is *called*, not when it is defined.

Closures may be "bound" to variables within the scope where they are defined:

```
def localMethod() {
  def localVariable = new java.util.Date()
  return { println localVariable }
}

def clos = localMethod()

println "Executing the closure:"
clos() //prints the date when "localVariable" was defined
```

Parameters

Closure parameters are listed before the `->` token, like so:

```
def clos = { a, b -> print a+b }
clos( 5, 7 ) //prints "12"
```

The `->` token is optional and may be omitted if your closure definition takes fewer than two parameters.

Implicit variables

Within a closure, several variables are defined that have special meaning:

It

If you have a closure that takes a single argument, you may omit the parameter definition of the closure, like so:

```
def clos = { print it }
clos( "hi there" ) //prints "hi there"
```

this, owner, and delegate

this : as in Java, `this` refers to the enclosing class where a Closure is defined

owner : the enclosing object (`this` or a surrounding closure)

delegate : by default the same as `owner`, but changeable for example in a [builder](#) or [ExpandoMetaClass](#)

Example:

```
class Class1 {
  def closure = {
    println this.class.name
    println delegate.class.name
  }
}
```

```

def nestedClos = {
println owner.class.name
}
nestedClos()
}
}

def clos = new Class1().closure
clos.delegate = this
clos()
/* prints:
Class1
Script1
Class1$_closure1 */

```

Closures as Method Arguments

When a method takes a closure as the last parameter, you can define the closure inline, like so:

```

def list = ['a','b','c','d']
def newList = []

list.collect( newList ) {
it.toUpperCase()
}
println newList           // ["A", "B", "C", "D"]

```

In the above example, the [collect](#) method accepts a `List` and a `Closure` argument. The same could be accomplished like so (although it is more verbose):

```

def list = ['a','b','c','d']
def newList = []

def clos = { it.toUpperCase() }
list.collect( newList, clos )

assert newList == ["A", "B", "C", "D"]

```

More Information

Groovy extends `java.lang.Object` with a number of methods that accept closures as arguments. See [GDK Extensions to Object](#) for practical uses of closures.

See Also:

- [Closures - Formal Definition](#)
- [Closures - Informal Guide](#)

Closures - Formal Definition

This page last changed on Sep 18, 2007 by [tomstrummer](#).

Formal Guide

A closure in Groovy is an anonymous chunk of code that may take arguments, return a value, and reference and use variables declared in its surrounding scope. In many ways it resembles anonymous inner classes in Java, and closures are often used in Groovy in the same way that Java developers use anonymous inner classes. However, Groovy closures are much more powerful than anonymous inner classes, and far more convenient to specify and use.

In functional language parlance, such an anonymous code block might be referred to as an anonymous lambda expression in general or lambda expression with unbound variables or a closed lambda expression if it didn't contain references to unbound variables (like `threshold` in the earlier example). Groovy makes no such distinction.

Strictly spoken a closure can't be defined. You can define a block of code that refers to local variables or fields/properties, but it becomes a closure only when you "bind" (give it a meaning) this block of code to variables. The closure is a semantic concept, like an instance, which you cannot define, just create. Strictly spoken a closure is only a closure if all free variables are bound. Unless this happens it is only partially closed, hence not really a closure. Since Groovy doesn't provide a way to define a closed lambda function and a block of code might not be a closed lambda function at all (because it has free variables), we refer to both as closure - even as syntactic concept. We are talking about it as syntactic concept, because the code of defining and creating an instance is one, there is no difference. We very well know that this terminology is more or less wrong, but it simplifies many things when talking about code in a language that doesn't "know" the difference.

Syntax for Defining a Closure

A closure definition follows this syntax:

```
{ [closureArguments->] statements }
```

Where `[closureArguments->]` is an optional comma-delimited list of arguments, and `statements` are 0 or more Groovy statements. The arguments look similar to a method's parameter list, and these arguments may be typed or untyped. When a parameter list is specified, the `->` character is required and serves to separate the arguments from the closure body. The `statements` portion consists of 0, 1, or many Groovy statements.

Some examples of valid closure definitions:

```
{ item++ }

{ println it }

{ ++it }

{ name -> println name }

{ String x, int y -> println "hey ${x} the value is ${y}" }

{ reader ->
while (true) {
def line = reader.readLine()
}
}
```

++++ *Note: The examples could definitely be made more real-life MWS*

Closure semantics

Closures appear to be a convenient mechanism for defining something like an inner class, but the semantics are in fact more powerful and subtle than what an inner class offers. In particular, the properties of closures can be summarized in this manner:

1. They have one implicit method (which is never specified in a closure definition) called `doCall()`
2. A closure may be invoked via the `call()` method, or with a special syntax of an unnamed `()` invocation. Either invocation will be translated by Groovy into a call to the Closure's `doCall()` method.
3. Closures may have 1...N arguments, which may be statically typed or untyped. The first parameter is available via an implicit untyped argument named *it* if no explicit arguments are named. If the caller does not specify any arguments, the first parameter (and, by extension, *it*) will be null.
4. The developer does not have to use *it* for the first parameter. If they wish to use a different name, they may specify it in the parameter list.
5. Closures always return a value. This may occur via either an explicit *return* statement, or as the value of the last statement in the closure body (e.g. an explicit return statement is optional).
6. A closure may reference any variables defined within its enclosing lexical scope. Any such variable is said to be bound to the closure
7. Any variables bound to a closure are available to the closure even when the closure is returned outside of the enclosing scope.
8. Closures are first class objects in Groovy, and are always derived from the class *Closure*. Code which uses closures may reference them via untyped variables or variables typed as *Closure*.
9. The body of a closure is not executed until it is explicitly invoked e.g. a closure is not invoked at its definition time
10. A closure may be *curried* so that one a copy the closure is made with one or more of its parameters fixed to a constant value

These properties are explained further in the following sections.

Closures are anonymous

Closures in Groovy are always represented as anonymous blocks. Unlike a Java or Groovy class, you cannot have a named closure. You may however reference closures using untyped variables or variables of type *Closure*, and pass such references as method arguments and arguments to other closures.

Implicit method.

Closures are considered to have one implicitly defined method, which corresponds to the closure's arguments and body. You cannot override or redefine this method. This method is always invoked by the `call()` method on the closure, or via the special unnamed `()` syntax. The implicit method name is `doCall()`.

Closure Arguments

A closure always has at least one argument, which will be available within the body of the closure via the implicit parameter *it* if no explicit parameters are defined. The developer never has to declare the *it* variable - like the *this* parameter within objects, it is implicitly available.

If a closure is invoked with zero arguments, then *it* will be null.

Explicit closure arguments may be specified by the developer as defined in the syntax section. These arguments are a list of 1 or more argument names which are comma separated. The parameter list is terminated with a `->` character. Each of these arguments may be specified "naked" e.g. without a type, or with an explicit static type. If an explicit parameter list is specified, then the *it* variable is not available.

For arguments that have a declared type, this type will be checked *at runtime*. If a closure invocation has 1 or more arguments which do not match the declared argument type(s), then an exception will be thrown at runtime. Note that this argument type checking always occurs at runtime; there is no static type checking involved, so the compiler will not warn you about mis-matched types.

Groovy has special support for excess arguments. A closure may be declared with its last argument of type *Object[]*. If the developer does this, any excess arguments at invocation time are placed in this array. This can be used as a form of support for variable numbers of arguments. For example:

```
def c = {
format, Object[] args ->
aPrintfLikeMethod (format, args)}
c ("one", "two", "three");
c ("1");
```

Both invocations of *c* are valid. Since the closure defines two arguments (*format* and *args*) and the last argument is of type *Object[]*, the first parameter in any call to *c* will be bound to the *format* argument and the remaining parameters will be bound to the *args* argument. In the first call of *c* the closure will receive the parameter *args* with 2 elements ("two", "three") while the *format* parameter will contain the string "one". In the second call the closure will receive the parameter *args* with no elements and the *format* parameter will contain the string "1".

++++ *What Exception is thrown? MWS*

Closure Return Value

Closures always have a return value. The value may be specified via one or more explicit *return* statement in the closure body, or as the value of the last executed statement if *return* is not explicitly specified. If the last executed statement has no value (for example, if the last statement is a call to a void method), then null is returned.

There is currently no mechanism for statically declaring the return type of a closure.

References to External Variables

Closures may reference variables external to their own definition. This includes local variables, method parameters, and object instance members. However, a closure may only reference those variables that the compiler can lexically deduce from the physical location of the closure definition within the source file.

Some examples might serve to clarify this. The following example is valid and shows a closure using a method's local variables and a method parameter:

```
public class A {
private int member = 20;

private String method()
{
return "hello";
}

def publicMethod (String name_)
{
def localVar = member + 5;
def localVar2 = "Parameter: ${name_}";
return {
println "${member} ${name_} ${localVar} ${localVar2} ${method()}"
}
}
}

A sample = new A();
def closureVar = sample.publicMethod("Xavier");
closureVar();
```

The above code will print out:

```
20 Xavier 25 Parameter: Xavier hello
```

Looking at the definition of class *A*, the closure inside of *publicMethod* has access to all variables that *publicMethod* may legally access. This is true whether the variables are local variables, parameters, instance members, or method invocations.

When a closure references variables in this way, they are bound to the closure. At the same time, the variables are still available normally to the enclosing scope, so the closure may read/change any such values, and code from the outer scope may read/change the same variables.

If such a closure is returned from its enclosing scope, the variables bound with the closure also live on. This binding occurs when the closure is instantiated. If an object method or instance member is used within a closure, then a reference to that object is stored within the closure. If a local variable or parameter is referenced, then the compiler re-writes the local variable or parameter reference so that the local variable or parameter is taken off the stack and stored in an heap based object.

It's important to keep in mind that these references only are ever allowed according to the lexical structure available to the compiler (in this case, the A class). This process does *not* occur dynamically by looking at the call stack. So the following will not work:

```
class A {
private int member = 20;

private void method()
{
return "hello";
}

def publicMethod (String name_)
{
def localVar = member + 5;
def localVar2 = "Parameter: name_";
return {
// Fails!
println "${member} ${name_} ${localVar} ${localVar2} ${method()} ${bMember}"
}
}
}

class B {
private int bMember = 12;

def bMethod (String name_)
{
A aInsideB = new A();
return (aInsideB.publicMethod (name_));
}
}

B aB = new B();
closureVar = aB.publicMethod("Xavier");
closureVar();
```

The above code is similar to the first example, except that we now have a class *B* which dynamically instantiates an object of type *A* and then calls *A*.publicMethod(). However, in this code the closure within publicMethod() is trying to reference a member from *B*, and this is not allowed since the compiler cannot statically determine that this is available. Some older languages allowed this sort of reference to work, by dynamically examining the call stack at runtime, but this is disallowed in Groovy.

Groovy supports the special *owner* variable which can be used when a closure argument is hiding an object member variable. For example:

```
class HiddenMember {
private String name;

def getClosure (String name)
{
return { name -> println (name)}
}
}
```

In the above code the *println (name)* call is referencing the parameter *name*. If the closure needs to access the name instance variable of class HiddenMember, it can use the owner variable to indicate this:

```
class HiddenMember {
private String name;
```

```
def getClosure (String name)
{
return { name -> println ("Argument: ${name}, Object: ${owner.name}")}
}
}
```

The Closure Type

All closures defined in Groovy are derived from the type *Closure*. Each unique closure definition with a Groovy program creates a new unique class which extends *Closure*. If you wish to specify the type of a closure in a parameter, local variable, or object member instance, then you should use the *Closure* type.

The exact type of a closure is not defined unless you are explicitly subclassing the *Closure* class. Using this example:

```
def c = { println it}
```

The exact type of the closure referenced by *c* is not defined, we know only that it is a subclass of *Closure*.

Closure creation and invocation

Closures are created implicitly when their surrounding scope encounters them. For example, in the following code two closures are created:

```
class A {
private int member = 20;

private method()
{
println ("hello");
}

def publicMethod (String name_)
{
def localVar = member + 5
def localVar2 = "Parameter: name_";
return {
println "${member} ${name_} ${localVar} ${localVar2} ${method()}"
}
}
}

A anA = new A();
closureVar = anA.publicMethod("Xavier");
closureVar();
closureVar2 = anA.publicMethod("Xavier");
closureVar2();
```

In the above example, *closureVar* holds a reference to a different closure object than *closureVar2*. Closures are always implicitly created in this manner - you cannot *new* a closure programmatically.

Closures may be invoked using one of two mechanisms. The explicit mechanism is to use the `call()` method:

```
closureVar.call();
```

You may also use the implicit nameless invocation approach:

```
closureVar();
```

If you are looking at the *Closure* javadoc, you may notice that the `call` method within the *Closure* class is defined as:

```
public Object call (Object[] args);
```

Despite this method signature, you do not have to manually write code to turn parameters into the `Object[]` array. Instead, invocations use the normal method argument syntax, and Groovy converts such calls to use an object array:

```
closure ("one", "two", "three")
closure.call ("one", "two", "three")
```

Both calls above are legal Groovy. However, if you are dealing with a Closure from Java code you will need to create the `Object[]` array yourself 😊

Fixing Closure Arguments to Constant Values Via Currying

You can fix the values for one or more arguments to a closure instance using the `curry()` method from the *Closure* type. In fact, this action is often referred to as currying in functional programming circles, and the result is generally referred to as a *Curried Closure*. Curried closures are very useful for creating generic closure definitions, and then creating several curried versions of the original with differing parameters bound to them.

When the `curry()` method is called on a closure instance with one or more arguments, a copy of the closure is first made. The incoming arguments are then bound permanently to the new closure instance so that the parameters 1..N to the `curry()` call are bound to the 1..N parameters of the closure. The new *curried closure* is then returned the caller.

Callers to the new instance will have their invocation parameters bound to the new closure in the N+1 parameter position of the original closure.

A simple example of this would be:

```
def c = { arg1, arg2-> println "${arg1} ${arg2}" }
def d = c.curry("foo")
d("bar")
```

The above code defines a closure *c*, and then calls *c.curry("foo")*. This returns a curried closure with the *arg1* value permanently bound to the value "foo". On the invocation *d("bar")*, the "bar" parameter comes into the closure in the *arg2* argument. The resulting output would be *foo bar*.

See also: [Functional Programming](#)

Special Case: Passing Closures to Methods

Groovy has a special case for defining closures as method arguments to make the closure syntax easier to read. Specifically, if the last argument of a method is of type *Closure*, you may invoke the method with an explicit closure block outside of the parenthesis. For example, if a class has a method:

```
class SomeCollection {
public void each (Closure c)
}
```

Then you may invoke `each()` with a closure definition outside of the parenthesis:

```
SomeCollection stuff = new SomeCollection();
stuff.each() { println it }
```

The more traditional syntax is also available, and also note that in Groovy you can elide parenthesis in many situations, so these two variations are also legal:

```
SomeCollection stuff = new SomeCollection();
stuff.each { println it } // Look ma, no parens
stuff.each ({ println it }) // Strictly traditional
```

The same rule applies even if the method has other arguments. The only restriction is that the Closure argument must be last:

```
class SomeCollection {
public void inject (x, Closure c)
```



```

}

stuff.inject(0) {count, item -> count + item } // Groovy
stuff.inject(0, {count, item -> count + item }) // Traditional

```

This syntax is only allowed when explicitly defining a closure within the method call. You cannot do this with a variable of type closure, as this example shows:

```

class SomeCollection {
public void inject (x, Closure c)
}

counter = {count, item -> count + item }
stuff.inject(0) counter // Illegal! No Groovy for you!

```

When you are not defining a closure inline to a method call, you cannot use this syntax and must use the more verbose syntax:

```

class SomeCollection {
public void inject (x, Closure c)
}

def counter = {count, item -> count + item }
stuff.inject(0,counter)

```

Comparing Closures to Anonymous Inner Classes

Groovy includes closures because they allow the developer to write more concise and more easily understood code. Where Java developers may use single-method interfaces (Runnable, the Command pattern) combined with anonymous inner classes, Groovy allows you to accomplish the same sort of tasks in a less verbose manner. In addition, closures have fewer constraints than anonymous inner classes and include extra functionality.

Most closures are relatively short, isolated, and anonymous snippets of code that accomplish one specific job. Their syntax is streamlined to make closure definitions very short and easy to read without additional clutter. For example, in Java code you might see code like this for an imaginary GUI system:

```

Button b = new Button ("Push Me");
b.onClick (new Action() {
public void execute (Object target)
{
buttonClicked();
}
});

```

The same code in Groovy would look like this:

```

Button b = new Button ("Push Me");
b.onClick { buttonClicked() }

```

The Groovy code accomplishes the same task but is much clearer and without extra syntactical clutter. This is the first

rule of Groovy closures - closures are trivially easy to write. In addition, closures may reference any variables in its outer

defining scope without the restrictions of anonymous inner classes - in particular, such variables do not need to be final.

Closures also carry their state around with them, even when they reference local variables and parameters. Closures may also take advantage of Groovy's optional dynamic typing so that you don't have to statically declare all of your closure arguments or return types (in fact, a Groovy closure can take varying numbers of parameters from invocation to invocation).

What Groovy closures lack compared to an approach using Command-like interfaces is the level of static typing involved. A Java interface rigidly enforces what type of objects can be used and the method(s) that may be called in it. In Groovy, all closures type equally as *Closure* and type checking of arguments (if specified in the closure definition) is deferred until Runtime.

Closures as map keys and values

It's possible to put closures in a map, both as keys and values.

Closures as keys

You can use a closure as a key. However, when putting it into the map you must "escape" it (as you would any other identifier you don't want treated as a string) by enclosing it in parens, like so:

```
f = { println "f called" }
m = [ (f): 123 ]
```

When accessing the value of the closure in the map you must use `get(f)` or `m[f]` as `m.f` will treat `f` as a string.

```
println m.get(f)    // 123
println m[f]       // 123
println m.f        // null
```

Closures as values

You can use a closure as a value. When invoking it though you must parenthesize the access, else it's treated as a call to a method on the map. If you don't like this syntax you might opt for using an `Expando`.

```
m = [ f: { println 'f called' } ]
//m.f()    // MissingMethodException
(m.f)()    // f called

m = new Expando( f: { println 'f called' } )
m.f()     // f called
```

Extending groovy with the use directive

You can provide your own specialized methods supporting closures by implementing a Java class containing such methods. These methods must be static and contain at least two parameters. The *first* parameter to the method must be the type on which the method should operate, and the *last* parameter must be a Closure type.

Consider the example below, which is a variant of the `eachFile` method which simply ignores files, and just prints the directories within the `dir` object on which the method operates.

```
dir = new File("/tmp")
use(ClassWithEachDirMethod.class) {
dir.eachDir {
println it
}
}
```

Take note of the `use()` directive. This will tell groovy where the `eachDir` method is implemented. Below is the Java code required to support the `eachDir` method on the `File` object, as shown.

```
public class ClassWithEachDirMethod {
public static void eachDir(File self, Closure closure) {
File[] files = self.listFiles();
for (int i = 0; i < files.length; i++) {
if (files[i].isDirectory()) {
closure.call(files[i]);
}
}
}
}
```

To support additional parameters, these should be placed between the first and last.

Informal Guide

When using the Java programming language most executable code is enclosed in either static class methods or instance methods. (Code can also be enclosed in constructors, initializers, and initialization expressions, but those aren't important here.) A method encloses code within curly brackets and assigns that block of code a method name. All such methods must be defined inside of a class of some type. For example, if you were to write a method that returned the square of any integer it may look like this:

```
package example.math;

public class MyMath {
    public static int square(int numberToSquare){
        return numberToSquare * numberToSquare;
    }
}
```

Now in order to use the `square()` method you need to reference the class and the method by name as follows:

```
import example.math.MyMath;
...
int x, y;
x = 2;
y = MyMath.square(x); // y will equal 4.
```

You can do the same thing in Groovy, but in groovy you can alternatively define the code without having to declare a class and a method as follows:

```
{ numberToSquare -> numberToSquare * numberToSquare }
```

In Groovy, this anonymous code block is referred to as a **closure** definition (see the Formal Guide section below for a more elaborate definition of terms). A closure definition is one or more program statements enclosed in curly brackets. A key difference between a closure and method is that closures do not require a class or a method name.

As you can see, the executable code is the same except you didn't need to declare a class or assign the code a method name. While illustrative, the previous example is not all that useful because there is no way to use that closure once its created. It has no identifier (method name) so how can you call it? To fix that you assign the closure to a variable when it's created. You can then treat that variable as the identifier of the closure and make calls on it.

The following shows the `square()` method re-written as a closure:

```
def x = 2

// define closure and assign it to variable 'c'
def c = { numberToSquare -> numberToSquare * numberToSquare }

// using 'c' as the identifier for the closure, make a call on that closure
def y = c(x) // shorthand form for applying closure, y will equal 4
def z = c.call(x) // longhand form, z will equal 4
```

What is really nice about closures is that you can create a closure, assign it to a variable, and then pass it around your program like any other variable. At first this seems a bit, well useless, but as you learn more about Groovy you'll discover that closures are used all over the place.

As an example, let's extend the `java.util.Vector` class from Java by adding a single method that allows you to apply a closure to every element in the vector. My new class, `GVector`, looks as follows:

```
package example
```

```

public class GVector extends java.util.Vector {
public void apply( c ){
for (i in 0..<size()){
this[i] = c(this[i])
}
}
}
}

```

The `apply()` method takes a closure as an input parameter. For each element in the `GVector`, the closure is called passing in the element. The resulting value is then used to replace the element. The idea is that you can modify the contents of the `GVector` in place using a closure which takes each element and converts into something else.

Now we can call our new `apply()` method with any closure we want. For example, we will create a new `GVector`, populate it with some elements, and pass in the closure we created earlier, the one that squares an integer value.

```

import example
def gVect = new GVector()
gVect.add(2)
gVect.add(3)
gVect.add(4)

def c = { numberToSquare -> numberToSquare * numberToSquare }

gVect.apply(c) // the elements in the GVector have all been squared.

```

Because the `apply()` method on the `GVector` can be used with any closure, you can use any closure. For example, the following uses a closure that simply prints out the item its passed.

```

import example
def gVect = new GVector()
gVect.add(2)
gVect.add(3)
gVect.add(4)

def c2 = { value -> println(value) }

gVect.apply(c2) // the elements in the GVector have all been printed.

```

If you were to run the above script, assuming `GVector` from earlier is on your classpath, the output would look like this:

```

C:/> groovy myscript.groovy
4
9
16
C:/>

```

In addition to assigning closures to variables, you can also declare them directly as arguments to methods. For example, the above code could be re-written in the following manner:

```

import example
def gVect = new GVector()
gVect.add(2)
gVect.add(3)
gVect.add(4)

gVect.apply{ value -> println(value) } // elements in GVector have been printed.

```

This example accomplishes the same thing as the first, but the closure is defined directly as an argument to the `apply` method of `GVector`.

The other important difference of a closure to a normal method is that a closure can refer to variables from the scope in which it is called (in fact this is where this language construct gets its name). Here is an example:

```
class Employee {
def salary
}
def highPaid(emps) {
def threshold = 150
return emps.findAll{ e -> e.salary > threshold }
}

def emps = [180, 140, 160].collect{ val -> new Employee(salary:val) }

println emps.size()           // prints 3
println highPaid(emps).size() // prints 2
```

In this example, the closure block `{ e -> e.salary > threshold }` refers to the `threshold` variable defined in the `highPaid()` method. The example also used a closure to create the `emps` list.

Closures vs. Code Blocks

A closure looks a lot like a regular Java or Groovy code block, but actually it's not the same. The code within a regular code block (whether its a method block, static block, synchronized block, or just a block of code) is executed by the virtual machine as soon as it's encountered. With closures the statements within the curly brackets are not executed until the `call()` is made on the closure. In the previous example the closure is declared in line, but it's not executed at that time. It will only execute if the `call()` is explicitly made on the closure. This is an important differentiator between closures and code blocks. They may look the same, but they are not. Regular Java and Groovy blocks are executed the moment they are encountered; closures are only executed if the `call()` is invoked on the closure.

Collections

This page last changed on Sep 18, 2007 by [tomstrummer](#).

Groovy has native language support for collections, lists, maps and arrays.

Lists

You can create lists as follows. Notice that [] is the empty list expression.

```
def list = [5, 6, 7, 8]
assert list.get(2) == 7
assert list[2] == 7
assert list instanceof java.util.List
```

```
def emptyList = []
assert emptyList.size() == 0
emptyList.add(5)
assert emptyList.size() == 1
```

Each list expression creates an implementation of [java.util.List](#).

See [Lists and Sets](#) for more information on using Lists.

Ranges

Ranges allow you to create a list of sequential values. These can be used as Lists since [Range](#) extends [java.util.List](#)

Ranges defined with the .. notation are inclusive (that is the list contains the from and to value).

Ranges defined with the ..< notation are exclusive, they include the first value but not the last value.

```
// an inclusive range
def range = 5..8
assert range.size() == 4
assert range.get(2) == 7
assert range[2] == 7
assert range instanceof java.util.List
assert range.contains(5)
assert range.contains(8)
```

```
// lets use an exclusive range
range = 5..<8
assert range.size() == 3
assert range.get(2) == 7
assert range[2] == 7
assert range instanceof java.util.List
assert range.contains(5)
assert ! range.contains(8)
```

Note that ranges are implemented efficiently, creating a lightweight Java object containing a from and to value.

Ranges can be used for any Java object which implements [java.lang.Comparable](#) for comparison and also have methods `next()` and `previous()` to return the next / previous item in the range.

e.g. you can use Strings in a range

```
// an inclusive range
def range = 'a'..'d'
assert range.size() == 4
assert range.get(2) == 'c'
assert range[2] == 'c'
assert range instanceof java.util.List
assert range.contains('a')
assert range.contains('d')
```

```
assert ! range.contains('e')
```

Ranges can be used to iterate using the `for` statement.

```
for (i in 1..10) {  
    println "Hello ${i}"  
}
```

but alternatively you can achieve the same effect, by iterating a range with *each* method:

```
(1..10).each { i ->  
    println "Hello ${i}"  
}
```

Ranges can be also used in the `switch` statements:

```
switch (years) {  
    case 1..10: interestRate = 0.076; break;  
    case 11..25: interestRate = 0.052; break;  
    default: interestRate = 0.037;  
}
```

Maps

Maps can be created using the following syntax. Notice that `[:]` is the empty map expression.

Map keys are strings by default: `[a:1]` is equivalent to `["a":1]`. But if you really want a variable to become the key, you have to wrap it between parentheses: `[(a):1]`.

```
def map = [name:"Gromit", likes:"cheese", id:1234]  
assert map.get("name") == "Gromit"  
assert map.get("id") == 1234  
assert map["name"] == "Gromit"  
assert map['id'] == 1234  
assert map instanceof java.util.Map
```

```
def emptyMap = [:]  
assert emptyMap.size() == 0  
emptyMap.put("foo", 5)  
assert emptyMap.size() == 1  
assert emptyMap.get("foo") == 5
```

Maps also act like beans so you can use the property notation to get/set items inside the Map provided that the keys are Strings which are valid Groovy identifiers.

```
def map = [name:"Gromit", likes:"cheese", id:1234]  
assert map.name == "Gromit"  
assert map.id == 1234
```

```
def emptyMap = [:]  
assert emptyMap.size() == 0  
emptyMap.foo = 5  
assert emptyMap.size() == 1  
assert emptyMap.foo == 5
```

Note: by design `map.foo` will always look for the key `foo` in `map`. This means `foo.class` will return null on an empty map and not result in calling the method `getClass()`

See [Maps](#) for more information on using maps.

Getting efficient with the star-dot '*' operator

You can perform operations on all the members of a collection using the '*' operator, e.g.:

```
assert [1, 3, 5] == ['a', 'few', 'words']*size()
```

Slicing with the subscript operator

You can index into Strings, Lists, arrays, Maps, regexs and such like using the subscript expression.

```
def text = "nice cheese gromit!"
def x = text[2]

assert x == "c"
assert x.class == String

def sub = text[5..10]
assert sub == 'cheese'

def map = [name:"Gromit", likes:"cheese", id:1234]

assert map["name"] == "Gromit"
assert map.name == "Gromit"

def list = [10, 11, 12]
def answer = list[2]
assert answer == 12
```

Notice that you can use ranges to extract part of a List/array/String/regex. This is often referred to as *slicing* in scripting languages like Python. You can also use a list of indexes too.

```
def list = 100..200
def sub = list[1, 3, 20..25, 33]
assert sub == [101, 103, 120, 121, 122, 123, 124, 125, 133]
```

You can update items using the subscript operator too

```
def list = ["a", "b", "c"]
list[2] = "d"
list[0] = list[1]
list[3] = 5
assert list == ["b", "b", "d", 5]
```

You can use negative indices to count from the end of the List, array, String etc.

```
def text = "nice cheese gromit!"
def x = text[-1]
assert x == "!"

def name = text[-7..-2]
assert name == "gromit"
```

Also if you use a backwards range (the starting index is greater than the end index) then the answer is reversed.

```
def text = "nice cheese gromit!"
def name = text[3..1]
assert name == "eci"
```

Dynamic objects (Expandos)

The Expando is not a collection in the strictest sense, but in some ways it is similar to a Map, or objects in JavaScript that do not have to have their properties defined in advance. It allows you to create dynamic

objects by making use of Groovy's [closure mechanisms](#). An [Expando](#) is different from a map in that you can provide synthetic methods that you can call on the object.

```
def player = new Expando()
player.name = "Dierk"
player.greeting = { "Hello, my name is $name" }

println player.greeting()
player.name = "Jochen"
println player.greeting()
```

The `player.greeting` assignment passes in a [closure](#) to execute when `greeting()` is called on the [Expando](#). Notice that the closure has access to the properties assigned to the [Expando](#), even though these values may change over time, using Groovy's [GString](#) "\$variableOrProperty" notation.

Control Structures

This page last changed on Sep 27, 2006 by [paulk_asert](#).

- [Logical Branching](#)
- [Looping](#)

Logical Branching

This page last changed on Nov 24, 2007 by [paulk_asert](#).

if - else statement

Groovy supports the usual if - else syntax from Java

```
def x = false
def y = false

if ( !x ) {
x = true
}

assert x == true

if ( x ) {
x = false
} else {
y = true
}

assert x == y
```

Groovy also supports the normal Java "nested" if then else if syntax:

```
if ( ... ) {
...
} else if (...) {
...
} else {
...
}
```

ternary operator

Groovy also supports the ternary operator:

```
def y = 5
def x = (y > 1) ? "worked" : "failed"
assert x == "worked"
```

See also: the [elvis operator](#)

switch statement

The switch statement in Groovy is backwards compatible with Java code; so you can fall through cases sharing the same code for multiple matches.

One difference though is that the Groovy switch statement can handle any kind of switch value and different kinds of matching can be performed.

```
def x = 1.23
def result = ""

switch ( x ) {
case "foo":
result = "found foo"
// lets fall through

case "bar":
result += "bar"

case [4, 5, 6, 'inList']:
result = "list"
```

```
break

case 12..30:
result = "range"
break

case Integer:
result = "integer"
break

case Number:
result = "number"
break

default:
result = "default"
}

assert result == "number"
```

Switch supports the following kinds of comparisons

- Class case values matches if the switchValue is an instance of the class
- Regular expression case value matches if the string of the switchValue matches the regex
- Collection case value matches if the switchValue is contained in the collection. This also includes ranges too (since they are Lists)
- if none of the above are used then the case value matches if the case value equals the switch value

How switch works

The case statement performs a *match* on the case value using the *isCase(switchValue)* method, which defaults to *call equals(switchValue)* but has been overloaded for various types like Class or regex etc.

So you could create your own kind of matcher class and add an *isCase(switchValue)* method to provide your own kind of matching.

Looping

This page last changed on Mar 05, 2007 by [sylphy](#).

Groovy supports the usual while {...} loops like Java.

```
def x = 0
def y = 5

while ( y-- > 0 ) {
  x++
}

assert x == 5
```

for loop

The for loop in Groovy is much simpler and works with any kind of array, collection, Map etc.

Note: the standard for loop is not implemented by beta-10.

// for (int i = 0; i < 5; ++i) // not implemented by beta-10.

```
// iterate over a range
def x = 0
for ( i in 0..9 ) {
  x += i
}
assert x == 45

// iterate over a list
x = 0
for ( i in [0, 1, 2, 3, 4] ) {
  x += i
}
assert x == 10

// iterate over an array
array = (0..4).toArray()
x = 0
for ( i in array ) {
  x += i
}
assert x == 10

// iterate over a map
def map = ['abc':1, 'def':2, 'xyz':3]
x = 0
for ( e in map ) {
  x += e.value
}
assert x == 6

// iterate over values in a map
x = 0
for ( v in map.values() ) {
  x += v
}
assert x == 6

// iterate over the characters in a string
def text = "abc"
def list = []
for ( c in text ) {
  list.add(c)
}
assert list == ["a", "b", "c"]
```

closures

In addition, you can use closures in place of most for loops, using `each()` and `eachWithIndex()`:

```
def stringList = [ "java", "perl", "python", "ruby", "c#", "cobol",
"groovy", "jython", "smalltalk", "prolog", "m", "yacc" ];

def stringMap = [ "Su" : "Sunday", "Mo" : "Monday", "Tu" : "Tuesday",
"We" : "Wednesday", "Th" : "Thursday", "Fr" : "Friday",
"Sa" : "Saturday" ];

stringList.each() { print " ${it}" }; println "";
// java perl python ruby c# cobol groovy jython smalltalk prolog m yacc

stringMap.each() { key, value -> println "${key} == ${value}" };
// Su == Sunday
// We == Wednesday
// Mo == Monday
// Sa == Saturday
// Th == Thursday
// Tu == Tuesday
// Fr == Friday

stringList.eachWithIndex() { obj, i -> println " ${i}: ${obj}" };
// 0: java
// 1: perl
// 2: python
// 3: ruby
// 4: c#
// 5: cobol
// 6: groovy
// 7: jython
// 8: smalltalk
// 9: prolog
// 10: m
// 11: yacc

stringMap.eachWithIndex() { obj, i -> println " ${i}: ${obj}" };
// 0: Su=Sunday
// 1: We=Wednesday
// 2: Mo=Monday
// 3: Sa=Saturday
// 4: Th=Thursday
// 5: Tu=Tuesday
// 6: Fr=Friday
```

Database features

This page last changed on Jan 05, 2008 by [paulk_asert](#).

Groovy supports a few neat ways to work with SQL more easily and to make SQL more Groovy. You can perform queries and SQL statements, passing in variables easily with proper handling of statements, connections and exception handling thanks to closures.

```
import groovy.sql.Sql

def foo = 'cheese'
def sql = Sql.newInstance("jdbc:mysql://localhost:3306/mydb", "user",
    "pswd", "com.mysql.jdbc.Driver")

sql.eachRow("select * from FOOD where type=${foo}") {
println "Gromit likes ${it.name}"
}
```

In the above example, you can refer to the various columns by name, using the property syntax on the row variable (e.g. `it.name`) or you can refer to the columns by their index (e.g. `it[0]`) For example:

```
import groovy.sql.Sql

def foo = 'cheese'
def sql = Sql.newInstance("jdbc:mysql://localhost:3306/mydb", "user",
    "pswd", "com.mysql.jdbc.Driver")

def answer = 0
sql.eachRow("select count(*) from FOOD where type=${foo}") { row ->
answer = row[0]
}
assert answer > 0
```

Or you can create a `DataSet` which allows you to query SQL using familiar closure syntax so that the same query could work easily on in memory objects or via SQL. e.g.

```
import groovy.sql.Sql

def sql = Sql.newInstance("jdbc:mysql://localhost:3306/mydb", "user",
    "pswd", "com.mysql.jdbc.Driver")

def food = sql.dataSet('FOOD')
def cheese = food.findAll { it.type == 'cheese' }
cheese.each { println "Eat ${it.name}" }
```

Advanced Usage

In this example, we create a table, make changes to it and confirm the changes worked.

```
def sql = Sql.newInstance("jdbc:mysql://localhost:3306/mydb",
    "user", "pswd", "com.mysql.jdbc.Driver")

// delete table if previously created
try {
sql.execute("drop table PERSON")
} catch(Exception e){}

// create table
sql.execute('''create table PERSON (
id integer not null primary key,
firstname varchar(20),
lastname varchar(20),
location_id integer,
location_name varchar(30)
)''')
```

```

// now let's populate the table
def people = sql.dataSet("PERSON")
people.add( firstname:"James", lastname:"Strachan", id:1, location_id:10, location_name:'London' )
people.add( firstname:"Bob", lastname:"Mcwhirter", id:2, location_id:20, location_name:'Atlanta' )
people.add( firstname:"Sam", lastname:"Pullara", id:3, location_id:30, location_name:'California' )

// do a query to check it all worked ok
def results = sql.firstRow("select firstname, lastname from PERSON where id=1").firstname
def expected = "James"
assert results == expected

// allow resultSets to be able to be changed
sql.resultSetConcurrency = java.sql.ResultSet.CONCUR_UPDATABLE

// change the data
sql.eachRow("select * from PERSON") {
it.firstname = it.firstname * 2
}

// reset resultSetsConcurrency back to read only (no further changes required)
sql.resultSetConcurrency = java.sql.ResultSet.CONCUR_READ_ONLY

// do a query to confirm that our change actually worked
results = sql.firstRow("select firstname, lastname from PERSON where id=1").firstname
expected = "JamesJames"
assert results == expected

```

Combining with MarkupBuilder Example

Here's an example of using Groovy SQL along with [GroovyMarkup](#) .

```

import groovy.sql.Sql
import groovy.xml.MarkupBuilder

def sql = Sql.newInstance("jdbc:mysql://localhost:3306/mydb", "user",
"pswd", "com.mysql.jdbc.Driver")

// lets output some XML builder
// could be SAX / StAX / DOM / TrAX / text etc
def xml = new MarkupBuilder()

def ignore = 'James'
sql.eachRow("select * from person where firstname != ${ignore}") { person ->
// lets process each row by emitting some markup
xml.customer(id:person.id, type:'Customer',
name:"$person.firstname $person.lastname" )
}

```

This could generate, dynamically something like

```

<customers>
<customer id="123" type="Customer" foo="whatever">
<role>partner</role>
<name>James</name>
<location id="5" name="London"/>
</customer>
</customers>

```

There's an example [test case which demonstrates](#) all of these query mechanisms in action.

Stored procedure support

```

import java.sql.Connection

```



```

import java.sql.DriverManager
import javax.sql.DataSource
import groovy.sql.Sql
import oracle.jdbc.driver.OracleTypes

driver = oracle.jdbc.driver.OracleDriver
Connection conn = DriverManager.getConnection(
'jdbc:oracle:thin:sirtest/sirtest@duck.aplpi.lan:1521:orcl');

/*
 *
 * Here we call a procedural block with a closure.
 * ${Sql.INTEGER} and ${Sql.VARCHAR} are out parameters
 * which are passed to the closure.
 *
 */
Sql sql = new Sql(conn);
def a="foo";
String foo = "x";
println "${a}=${a}"
undefinedVar = null
println ""
--Simple demonstration of call with closure.
--Closure is called once with all returned values.
""
sql.call("begin ${Sql.INTEGER}:=20; ${Sql.VARCHAR}:='hello world';end;") {
answer,string ->

println "number=[${answer}] string=[${string}]"
println "answer is a ${answer.class}";
println "string is a ${string.class}";
answer += 1;
println "now number=${answer}"
println ""[${string.replaceAll('o','O')}]""
}

/*
 * Here we execute a procedural block. The block returns four out
 * parameters, two of which are cursors. We use Sql.resultSet function
 * to indicate that the cursors should be returned as GroovyResultSet.
 *
 *
 */
println ""--next we see multiple return values including two ResultSets
--(ResultSets become GroovyResultSets)
--Note the GroovyResultSet.eachRow() function!!
""

def tableClosure = {println "table:${it.table_name}"};
println("tableClosure is a ${tableClosure.class}");
String owner = 'SIRTEST';

sql.call("""declare
type crsr is ref cursor;
tables crsr;
objects crsr;
begin
select count(*) into ${Sql.INTEGER} from all_tables where owner= ${owner} ;
open tables for select * from all_tables where owner= ${owner} ;
${Sql.resultSet OracleTypes.CURSOR} := tables;
select count(*) into ${Sql.INTEGER} from all_objects where owner= ${owner} ;
open objects for select * from all_objects where owner= ${owner};
${Sql.resultSet OracleTypes.CURSOR} := objects;
end;

```

```

"""
){t,user_tables,o,user_objects ->
println "found ${t} tables from a total of ${o} objects"
// eachRow is a new method on GroovyResultSet
user_tables.eachRow(){x ->println "table:${x.table_name}" }
user_objects.eachRow(){println "object:${it.object_name}" }
}

/*
 * Determine if we have the stored procedure 'fred' needed
 * for the next test.
 *
 */
Integer procLines = 0
sql.eachRow("select count(*) lines from user_source where name='FRED' and type='FUNCTION'){
procLines = it.lines
}

if(procLines ==0) {
print """
--to demonstrate a function accepting an inout parameter
--and returning a value, create the following function in your schema
create or replace function fred(foo in out varchar2) return number is
begin
foo:='howdy doody';
return 99;
end;
"""

}else{
/*
 * Here is a call to a function, passing in inout parameter.
 * The function also returns a value.
 */
println "Next call demonstrates a function accepting inout parameter and returning a value"
sql.call("{ ${Sql.INTEGER} = call fred(${Sql.inout(Sql.VARCHAR(foo))) }") {
answer,string ->
println "returned number=[${answer}] inout string coming back=[${string}]"
}

println "--Same again, but this time passing a null inout parameter"
sql.call("{ ${Sql.INTEGER} = call fred(${Sql.inout(Sql.VARCHAR(undefinedVar))) }") {
answer,string ->
println "returned number=[${answer}] inout string coming back=[${string}]"
answer = answer + 1;
println "Checked can increment returned number, now number=${answer}"
println ""[${string.replaceAll('o','O')}]""
}

}

/*
 * Finally a handy function to tell Sql to expand a variable in the
 * GString rather than passing the value as a parameter.
 *
 */
["user_tables","all_tables"].each(){table ->
sql.eachRow("select count(*) nrows from ${Sql.expand table}") {
println "${table} has ${it.nrows} rows"
}
}
}

```

Clob Notes

CLOB are objects that cannot be extracted with a piece of code like:

```
data = sql.rows("select clobdata from ....")
```

because later

```
data.each { ... do something ... }
```

can fail. This happens cause the object is not *reachable* any more since the connection might be already closed: note I say might cause at least on Oracle the errors are random (and hard to understand).

A possible way to act on CLOB data is to use `eachRow`

```
data = sql.eachRow("select clobdata from ....") { ... do something ... }
```

Further Information

There is also an additional [GSQL](#) module you might want to check out.

Dynamic Groovy

This page last changed on Oct 02, 2007 by [glaforge](#).

This section details how to go about using the dynamic features of Groovy such as implementing the `GroovyObject` interface and using `ExpandoMetaClass`, an expandable `MetaClass` that allows adding of methods, properties and constructors.

- [Using invokeMethod and getProperty](#)
- [Using methodMissing and propertyMissing](#)
- [Evaluating the MetaClass runtime](#)
- [Using ExpandoMetaClass to add behaviour](#)
- [Customizing MetaClass for a single instance](#)

Dynamic Method Invocation

You can invoke a method even if you don't know the method name until it is invoked:

```
class Dog {
  def bark() { println "woof!" }
  def sit() { println "(sitting)" }
  def jump() { println "boing!" }
}

def doAction( animal, action ) {
  animal."$action"()           //action name is passed at invocation
}

def rex = new Dog()

doAction( rex, "bark" )        //prints 'woof!'
doAction( rex, "jump" )       //prints 'boing!'
```

You can also "spread" the arguments in a method call, when you have a list of arguments:

```
def max(int i1, int i2) {
  Math.max(i1, i2)
}
def numbers = [1, 2]
assert max( *numbers ) == 2
```

This also works in combination of the invocation with a `GString`:

```
someObject."$methodName"(*args)
```

Evaluating the MetaClass runtime

This page last changed on Sep 10, 2007 by graemerocher@yahoo.co.uk.

Evaluating the MetaClass runtime

Since 1.1, Groovy supports a much richer set of APIs for evaluating the MetaClass runtime. Using these APIs in combination with [ExpandoMetaClass](#) makes Groovy an extremely powerful language for meta-programming

Finding out methods and properties

To obtain a list of methods (or [MetaMethod](#) instances in Groovy speak) for a particular Groovy class use can inspect its MetaClass:

```
println obj.metaClass.methods
println obj.metaClass.methods.find { it.name.startsWith("to" ) }
```

The same can be done for properties:

```
println obj.metaClass.properties
println obj.metaClass.properties.find { it.name.startsWith("to" ) }
```

Using respondsTo and hasProperty

Obtaining a list of methods sometimes is a little more than what you want. It is quite common in meta-programming scenarios to want to find out if an object supports a particular method.

Since 1.1, you can use `respondsTo` and `hasProperty` to achieve this:

```
class Foo {
String prop
def bar() { "bar" }
def bar(String name) { "bar $name" }
def add(Integer one, Integer two) { one + two }
}

def f = new Foo()

if(f.metaClass.respondsTo(f, "bar")) {
// do stuff
}

if(f.metaClass.respondsTo(f, "bar", String)) {
// do stuff
}

if(!f.metaClass.respondsTo(f, "bar", Integer)) {
// do stuff
}

if(f.metaClass.respondsTo(f, "add", Integer, Integer)) {
// do stuff
}

if(f.metaClass.hasProperty(f, "prop")) {
// do stuff
}
```

The `respondsTo` method actually returns a List of `MetaMethod` instances so you can use it to both query and evaluate the resulting list.



respondsTo only works for "real" methods and those added via [ExpandoMetaClass](#) and not for cases where you override invokeMethod or methodMissing. It is impossible in these cases to tell if an object responds to a method without actually invoking the method.

ExpandoMetaClass

This page last changed on Sep 05, 2007 by [tomstrummer](#).

Using ExpandoMetaClass to add behaviour

Groovy 1.1 includes a special MetaClass called an ExpandoMetaClass that allows you to dynamically add methods, constructors, properties and static methods using a neat closure syntax.

How does it work? Well every `java.lang.Class` is supplied with a special "metaClass" property that when used will give you a reference to an ExpandoMetaClass instance.

For example given the Java class `java.lang.String` to obtain its ExpandoMetaClass you can use:

```
String.metaClass.swapCase = {->
def sb = new StringBuffer()
delegate.each {
sb << (Character.isUpperCase(it as char) ? Character.toLowerCase(it as char) :
Character.toUpperCase(it as char))
}
sb.toString()
}
```

This adds a method called `swapCase` to the `String` class.



By default ExpandoMetaClass doesn't do inheritance. To enable this you must call `ExpandoMetaClass.enableGlobally()` before your app starts such as in the main method or servlet bootstrap

Further Reading:

- [ExpandoMetaClass - Borrowing Methods](#) — Borrowing methods from other classes
- [ExpandoMetaClass - Constructors](#) — Adding or overriding constructors
- [ExpandoMetaClass - Dynamic Method Names](#) — Dynamically creating method names
- [ExpandoMetaClass - GroovyObject Methods](#) — Overriding `invokeMethod`, `getProperty` and `setProperty`
- [ExpandoMetaClass - Interfaces](#) — Adding methods on interfaces
- [ExpandoMetaClass - Methods](#) — Adding or overriding instance methods
- [ExpandoMetaClass - Overriding static invokeMethod](#) — Overriding `invokeMethod` for static methods
- [ExpandoMetaClass - Properties](#) — Adding or overriding properties
- [ExpandoMetaClass - Runtime Discovery](#) — Overriding `invokeMethod` for static methods
- [ExpandoMetaClass - Static Methods](#) — Adding or overriding static methods

ExpandoMetaClass - Borrowing Methods

This page last changed on Sep 05, 2007 by [tomstrummer](#).

ExpandoMetaClass - Borrowing Methods from other classes

With ExpandoMetaClass you can also use Groovy's method pointer syntax to borrow methods from other classes. For example:

```
class Person {
String name
}
class MortgageLender {
def borrowMoney() {
"buy house"
}
}

def lender = new MortgageLender()

Person.metaClass.buyHouse = lender.&borrowMoney

def p = new Person()

assert "buy house" == p.buyHouse()
```

This page last changed on Sep 05, 2007 by [tomstrummer](#).

ExpandoMetaClass - Adding constructors

Adding constructors is a little different to adding a method with ExpandoMetaClass. Essentially you use a special "constructor" property and either use the << or = operator to assign a closure. The arguments to the closure are of course the constructor arguments

```
class Book {
String title
}
Book.metaClass.constructor << { String title -> new Book(title:title) }
```

```
def b = new Book("The Stand")
```

Be careful when adding constructors however, as it is very easy to get into stack overflow troubles. For example this code which overrides the default constructor:

```
class Book {
String title
}
Book.metaClass.constructor = { new Book() }
```

```
def b = new Book("The Stand")
```

The above would produce a StackOverflowError as it recursively keeps calling the same constructor through Groovy's MetaClass system. You can get around this by writing helper code to instantiate an instance outside of Groovy. For example this uses Spring's BeanUtils class and does not cause a StackOverflow:

```
class Book {
String title
}
Book.metaClass.constructor = { BeanUtils.instantiateClass(Book) }
```

```
def b = new Book("The Stand")
```

This page last changed on Sep 05, 2007 by [tomstrummer](#).

ExpandoMetaClass - Dynamic method/ property name creation

Since Groovy allows you to use Strings as property names this in turns allows you to dynamically create method and property names at runtime.

The Basics

To create a method with a dynamic name simply use Groovy's feature of reference property names as strings. You can combine this with Groovy's string interpolation (Gstrings) to create method and property names on the fly:

```
class Person {  
    String name = "Fred"  
}
```

```
def methodName = "Bob"
```

```
Person.metaClass."changeNameTo${methodName}" = { -> delegate.name = "Bob" }
```

```
def p = new Person()
```

```
assert "Fred" == p.name
```

```
p.changeNameToBob()
```

```
assert "Bob" == p.name
```

The same concept can be applied to static methods and properties.

A more elaborate example

In Grails we have a concept of dynamic codecs, classes that can encode and decode data.

These classes are called HTMLCodec, JavaScriptCodec etc. an example of which can be seen below:

```
import org.springframework.web.util.HtmlUtils  
class HTMLCodec {  
    static encode = { theTarget ->  
        HtmlUtils.htmlEscape(theTarget.toString())  
    }
```

```
    static decode = { theTarget ->  
        HtmlUtils.htmlUnescape(theTarget.toString())  
    }  
}
```

So what we do with these classes is to evaluate the convention and add "encodeAsXXX" methods to every object based on the first part of the name of the codec class such as "encodeAsHTML". The pseudo code to achieve this is below:

```
def codecs = classes.findAll { it.name.endsWith('Codec') }  
  
codecs.each { codec ->  
    Object.metaClass."encodeAs${codec.name-'Codec'}" = { codec.newInstance().encode(delegate) }  
    Object.metaClass."decodeFrom${codec.name-'Codec'}" = { codec.newInstance().decode(delegate) }  
}
```

```
def html = '<html><body>hello</body></html>'
```

```
assert '&lt;html&gt;&lt;body&gt;hello&lt;/body&gt;&lt;/html&gt;' == html.encodeAsHTML()
```

As you can see from the above we dynamically construct the names of the methods using GString expressions!

This page last changed on Sep 05, 2007 by [tomstrummer](#).

ExpandoMetaClass - Overriding invokeMethod, getProperty and setProperty

It is also possible to override the methods `invokeMethod`, `getProperty` and `setProperty` on `ExpandoMetaClass` thus allowing even more dynamic behaviour.

Overriding invokeMethod

As an example of overridding `invokeMethod`, take this simple example:

```
class Stuff {
def invokeMe() { "foo" }
}

Stuff.metaClass.invokeMethod = { String name, args ->
def metaMethod = Person.metaClass.getMetaMethod(name, args)
def result
if(metaMethod) result = metaMethod.invoke(delegate,args)
else {
result = "bar"
}
result
}

def stf = new Stuff()

assert "foo" == stf.invokeMe()
assert "bar" == stf.doStuff()
```

So what is happening here? Well firstly we've overridden `invokeMethod` by assigning it an appropriate closure, but in addition we first look-up a [MetaMethod](#) with the line:

```
def metaMethod = delegate.class.metaClass.getMetaMethod(name)
```

A [MetaMethod](#) in Groovy is a method that is known to exist on the `MetaClass` whether added at runtime or whatever, thus we check if there is an existing [MetaMethod](#) and if there isn't we simply return "bar", hence the behaviour of the assert statements is correct.

Overriding getProperty and setProperty

Again overriding `getProperty` and `setProperty` is similar to the above:

```
class Person {
String name = "Fred"
}

Person.metaClass.getProperty = { String name ->
def metaProperty = Person.metaClass.getMetaProperty(name)
def result
if(metaProperty) result = metaProperty.getProperty(delegate)
else {
result = "Flintstrone"
}
result
}

def p = new Person()
```

```
assert "Fred" == stf.name
assert "Flintstone" == stf.other
```

The important thing to note here is that instead of a `MetaMethod` we look-up a [MetaProperty](#) instance if that exists we call the `getProperty` method of the [MetaProperty](#) passing the delegate (ie the instance of the class).

The only different with `setProperty` is you need the value in the method signature and to call `setProperty` on the `MetaProperty`:

```
Person.metaClass.setProperty = { String name, value ->
...
if(metaProperty) metaProperty.setProperty(delegate, value)
...
}
```

Useful References

- [MetaMethod](#)
- [MetaProperty](#)

This page last changed on Sep 05, 2007 by [tomstrummer](#).

ExpandoMetaClass - Adding methods to interfaces

It is possible to add methods onto interfaces with ExpandoMetaClass. To do this however, it MUST be enabled globally using the `ExpandoMetaClass.enableGlobally()` method before application start-up.

As an example this code adds a new method to all implementors of `java.util.List`:

```
List.metaClass.sizeDoubled = {-> delegate.size() * 2 }

def list = []

list << 1
list << 2

assert 4 == list.sizeDoubled()
```

Another example taken from Grails, this code allows access to session attributes using Groovy's subscript operator to all implementors of the `HttpSession` interface:

```
HttpSession.metaClass.getAt = { String key ->
delegate.getAttribute(key)
}
HttpSession.metaClass.putAt = { String key, Object val ->
delegate.setAttribute(key, val)
}

def session = new MockHttpSession()

session.foo = "bar"
```

ExpandoMetaClass - Methods

This page last changed on Sep 05, 2007 by [tomstrummer](#).

ExpandoMetaClass - Adding & Overriding instance methods

Once you have an ExpandoMetaClass to add new methods to it is trivial:

```
class Book {
  String title
}

Book.metaClass.titleInUpperCase << {-> title.toUpperCase() }

def b = new Book(title:"The Stand")

assert "THE STAND" == b.titleInUpperCase()
```

Note that in this case the left shift << operator is used to "append" the new method. If the method already exists an exception will be thrown. If you want to replace an instance method you can use the = operator:

```
Book.metaClass.toString = {-> title.toUpperCase() }
```

This page last changed on Sep 05, 2007 by [tomstrummer](#).

ExpandoMetaClass - Overriding invokeMethod for static methods

It is also possible to override invokeMethod for static methods.

Overriding invokeMethod for static

As an example of overriding invokeMethod for static methods, take this simple example:

```
class Stuff {
  static invokeMe() { "foo" }
}

Stuff.metaClass.'static'.invokeMethod = { String name, args ->
  def metaMethod = Person.metaClass.getStaticMetaMethod(name, args)
  def result
  if(metaMethod) result = metaMethod.invoke(delegate,args)
  else {
    result = "bar"
  }
  result
}

assert "foo" == Stuff.invokeMe()
assert "bar" == Stuff.doStuff()
```

So what is happening here? Well firstly we've overridden `invokeMethod` using the 'static' qualifier and by assigning it an appropriate closure, but in addition we first look-up a [MetaMethod](#) with the line:

```
def metaMethod = delegate.class.metaClass.getStaticMetaMethod(name)
```

A [MetaMethod](#) in Groovy is a method that is known to exist on the MetaClass whether added at runtime or whatever, thus we check if there is an existing [MetaMethod](#) and if there isn't we simply return "bar", hence the behaviour of the assert statements is correct.

Useful References

- [MetaMethod](#)
- [MutableMetaClass](#)
- [MetaObjectProtocol](#)

ExpandoMetaClass - Properties

This page last changed on Sep 05, 2007 by [tomstrummer](#).

Adding properties

Properties can be added in a couple of ways. Firstly you can use the instance method syntax seen previously:

```
class Book {
  String title
}
Book.metaClass.getAuthor << {-> "Stephen King" }

def b = new Book("The Stand")

assert "Stephen King" == b.author
```

In this case the property is dictated by the closure and is a read-only property. You can add the equivalent setter but then remember you will have to store the property somewhere for retrieval later so make sure you use thread safe code. For example you could store values in a synchronized Map using the object identity as the key:

```
def properties = Collections.synchronizedMap([:])

Book.metaClass.setAuthor = { String value ->
  properties[System.identityHashCode(delegate) + "author"] = value
}
Book.metaClass.getAuthor = {->
  properties[System.identityHashCode(delegate) + "author"]
}
```

This is not the only technique however. For example in a servlet contain you may store the values in the currently executing request as request attributes (as is done in some cases in Grails).

Alternatively you can simply assign a value as follows:

```
Book.metaClass.author = "Stephen King"
def b = new Book("The Stand")

assert "Stephen King" == b.author
```

In this case the property is mutable and has both a setter and getter.



However, using this technique the property is stored in a ThreadLocal, WeakHashMap so don't expect the value to stick around forever!

ExpandoMetaClass - Runtime MetaClass Analysis

At runtime it is often useful to know what other methods or properties exist at the time the method is executed. To this end ExpandoMetaClass provides the following methods as of this writing:

- `getMetaMethod`
- `hasMetaMethod`
- `getMetaProperty`
- `hasMetaProperty`

Why can't you just use reflection? Well because Groovy is different, it has the methods that are "real" methods and methods that are available only at runtime. These are sometimes (but not always) represented as MetaMethods. The MetaMethods tell you what methods are available at runtime, thus your code can adapt.

This is of particular use when [overriding invokeMethod, getProperty and/or setProperty](#) for example:

```
class Stuff {
def invokeMe() { "foo" }
}

Stuff.metaClass.invokeMethod = { String name, args ->
def metaMethod = Person.metaClass.getMetaMethod(name)
def result
if(metaMethod) result = metaMethod.invoke(delegate,args)
else {
result = "bar"
}
result
}

def stf = new Stuff()

assert "foo" == stf.invokeMe()
assert "bar" == stf.doStuff()
```

Here we are using the `getMetaMethod` method to obtain a reference to a method that may or may not exist. If it doesn't exist the `getMetaMethod` method will return null and the code can adapt to this fact.

Useful References

- [MetaMethod](#)
- [MetaProperty](#)

This page last changed on Sep 05, 2007 by [tomstrummer](#).

ExpandoMetaClass - Adding static methods

Static methods can also be added using the same technique as instance methods with the addition of the "static" qualifier before the method name:

```
class Book {
  String title
}

Book.metaClass.'static'.create << { String title -> new Book(title:title) }

def b = Book.create("The Stand")
```

Adding Methods to an Instance

Normally when you add a `MetaMethod`, it is added for *all instances* of that class. However, for `GroovyObjects`, you can dynamically add methods to individual instances by giving that instance its own `MetaClass`:

```
def test = "test"
def gstr = "hello $test"    // this is a GString, which implements GroovyObject

def emc = new ExpandoMetaClass( gstr.class, false )
emc.test = { println "test" }
emc.initialize()

gstr.metaClass = emc
gstr.test()                // prints "test"
```

Note that you **cannot** do this:

```
gstr.metaClass = new ExpandoMetaClass( gstr.class )
gstr.metaClass.test = { println "test" }
```

because you *must* call `emc.initialize()` before making any method calls on the instance. But you can't add `MetaMethods` after calling `initialize()`! This is bit of a catch 22 because the `ExpandoMetaClass` is intercepting methods to itself. The solution is (as shown in the first example) to simply add the `MetaMethods` before assigning the new `MetaClass` to your instance.

The other option is to set the set `emc.allowChangesAfterInit = true`. This will allow you to add additional methods on the `MetaClass` after it is in use.



Note

Be sure to use the proper constructor, `new ExpandoMetaClass(MyClass, false)`. The `false` parameter keeps the `MetaClass` from being inserted into the Registry. Otherwise your new `MetaClass` will be used for all instances of `MyClass`, not just the instance it is assigned to.



Compatibility

Only works in Groovy 1.1-beta-3 and above. Use the `Proxy` class in older versions to achieve a per-instance behaviour change.

If your Instance is not a GroovyObject

If your instance is a plain Java type, it will not implement `GroovyObject`, and consequently, will not have a `metaClass` property. In this case you must wrap your instance in a `{{ groovy.util.Proxy }}`

```
{{}}
```

```
:
```

```
ExpandoMetaClass emc = new ExpandoMetaClass( Object, false )
emc.boo = { "Surprise!" }
emc.initialize()
```

```
def obj = new groovy.util.Proxy().wrap( new Object() )
obj.setMetaClass( emc )
assert obj.boo() == "Surprise!"
```

Note that this example is calling the `setMetaClass(...)` method rather than using the property notation in the previous example. This is because `Proxy` intercepts *method calls* only, not property access.

Using invokeMethod and getProperty

This page last changed on Feb 06, 2008 by [jheldmann](#).

Using invokeMethod & getProperty

Since 1.0, Groovy supports the ability to intercept *all* method and property access via the `invokeMethod` and `get/setProperty` hooks. If you only want to intercept failed method/property access take a look at [Using methodMissing and propertyMissing](#).

Overriding invokeMethod

In any Groovy class you can override `invokeMethod` which will essentially intercept all method calls (to intercept calls to existing methods, the class additionally has to implement the `GroovyInterceptable` interface). This makes it possible to construct some quite interesting DSLs and builders.

For example a trivial `XmlBuilder` could be written as follows (note Groovy ships with much richer XML APIs and this just serves as an example):

```
class XmlBuilder {
  def out
  XmlBuilder(out) { this.out = out }
  def invokeMethod(String name, args) {
    out << "<$name>"
    if(args[0] instanceof Closure) {
      args[0].delegate = this
      args[0].call()
    }
    else {
      out << args[0].toString()
    }
    out << "</$name>"
  }
}
def xml = new XmlBuilder()
xml.html {
  head {
    title "Hello World"
  }
  body {
    p "Welcome!"
  }
}
```

Overriding getProperty and setProperty

You can also override property access using the `getProperty` and `setProperty` property access hooks. For example it is possible to write a trivial "Expandable" object using this technique:

```
class Expandable {
  def storage = [:]
  def getProperty(String name) { storage[name] }
  void setProperty(String name, value) { storage[name] = value }
}

def e = new Expandable()
e.foo = "bar"
println e.foo
```

Using methodMissing and propertyMissing

This page last changed on Feb 24, 2008 by [glaforge](#).

Using methodMissing & propertyMissing

Since 1.5, Groovy supports the concept of "methodMissing". This differs from `invokeMethod` in that it is only invoked in the case of failed method dispatch.

There are a couple of important aspects to this behaviour:

1. Since `methodMissing`/`propertyMissing` only occur in the case of failed dispatch, they are expensive to execute
2. Since `methodMissing`/`propertyMissing` aren't intercepting EVERY method call like `invokeMethod` they can be more efficient with a few meta-programming tricks

Using methodMissing with dynamic method registration

Typically when using `methodMissing` the code will react in some way that makes it possible for the next time the same method is called, that it goes through the regular Groovy method dispatch logic.

For example consider [dynamic finders](#) in GORM. These are implemented in terms of `methodMissing`. How does it work? The code resembles something like this:

```
class GORM {

def dynamicMethods = [...] // an array of dynamic methods that use regex
def methodMissing(String name, args) {
def method = dynamicMethods.find { it.match(name) }
if(method) {
GORM.metaClass."$name" = { Object[] varArgs ->
method.invoke(delegate, name, varArgs)
}
return method.invoke(delegate,name, args)
}
else throw new MissingMethodException(name, delegate, args)
}
}
```

Notice how, if we find a method to invoke then we dynamically register a new method on the fly using [ExpandoMetaClass](#). This is so that the next time the same method is called it is more efficient. This way `methodMissing` doesn't have the overhead of `invokeMethod` AND is not expensive for the second call

Using propertyMissing

Groovy also supports `propertyMissing` for dealing with property resolution attempts. For a getter you use a `propertyMissing` definition that takes a `String` argument:

```
class Foo {
def propertyMissing(String name) { name }
}

def f = new Foo()

assertEquals "boo", f.boo
```

For a setters you add a second `propertyMissing` definition that takes a `value` argument:

```
class Foo {
def storage = [:]
def propertyMissing(String name, value) { storage[name] = value }
def propertyMissing(String name) { storage[name] }
}
```

```
def f = new Foo()  
f.foo = "bar"  
  
assertEquals "bar", f.foo
```

As with `methodMissing` you will likely want to dynamically register new properties at runtime to improve the performance of you code.

Static methods and properties

You can add `methodMissing` and `propertyMissing` that deals with static methods and properties via [ExpandoMetaClass](#)

GDK Extensions to Object

This page last changed on Sep 20, 2007 by [tomstrummer](#).

Groovy adds a number of methods to `java.lang.Object`, most of which deal with types that serve as collections or aggregates, such as Lists or DOM Nodes.

Return Value	Method	Description
Boolean	<code>any {closure}</code>	returns <code>true</code> if the closure returns true for any item
List	<code>collect {closure}</code>	returns a list of all items that were returned from the closure
Collection	<code>collect(Collection collection) {closure}</code>	same as above, but adds each item to the given collection
void	<code>each {closure}</code>	simply executes the closure for each item
void	<code>eachWithIndex {closure}</code>	same as <code>each{}</code> except it passes two arguments: the item and the index
Boolean	<code>every {closure}</code>	returns <code>true</code> if the closure returns true for <i>all</i> items
Object	<code>find {closure}</code>	returns the first item that matches the closure expression
List	<code>findAll {closure}</code>	returns all items that match the closure expression
Integer	<code>indexOf {closure}</code>	returns the index of the first item that matched the given expression

See the [GDK documentation on Object](#) for the complete list of added methods.

Since the "return" keyword is optional in Groovy, closures in this context act as "predicates" and return the boolean result of whatever expression you given in your closure. These predicates allow you to apply perform operations on aggregate objects in a very concise manner.

Examples

```
def numbers = [ 5, 7, 9, 12 ]
assert numbers.any { it % 2 == 0 } //returns true since 12 is even

assert numbers.every { it > 4 } //returns true since all #s are > 4

assert numbers.findAll { it in 6..10 } == [7,9] //returns all #s > 5 and < 11

assert numbers.collect { ++it } == [6, 8, 10, 13] //returns a new list with each #
incremented

numbers.eachWithIndex{ num, idx -> println "$idx: $num" } //prints each index and number
```

Generics

This page last changed on Feb 04, 2008 by sean@msgilligan.com.

Java 1.5 introduced Generics. Using generics you can write code that can be statically checked to a greater degree at compile time. In some ways this is at odds with the emphasis of dynamic languages where in general, the type of objects can not be determined until runtime. But Groovy aims to accomodate Java's static typing when possible, hence Groovy 1.5 now also understands Generics. Having said that, Groovy's generics support doesn't aim to be a complete clone of Java's generics. Instead, Groovy aims to allow generics at the source code level (to aid cut and pasting from Java) and also where it makes sense to allow good integration between Groovy and Java tools and APIs that use generics.

You can include generics in your definitions like this:

```
import java.lang.reflect.Method
Iterable<Method> methods = String.methods.grep{ it.name.startsWith('get') }
assert methods.name == ["getBytes", "getBytes", "getBytes", "getBytes", "getChars", "getClass"]
```

Implementation note: Java's generics implementation incorporates a feature known as "type erasure" which "throws away" generic type information after completing static type checking. This allows Java to easily integrate with legacy "non-generics" libraries. Groovy currently does a little further and throws away generics information "at the source level". Generics information is kept within signatures where appropriate (see for example the method *foo* below within class *D*).

You can define classes using generics like this:

```
class A extends ArrayList<Long> {}

class B<T> extends HashMap<T,List<T>> {}

class C<Y,T extends Map<String,Map<Y,Integer>>> {}

class D {
    static < T > T foo(T t) {return null}
}
```

GMaven

This page last changed on Apr 21, 2008 by [user57](#).



GMaven provides integration of the [Groovy](#) language into [Maven](#).

With GMaven you can:

- [Build Groovy Projects](#)
- [Execute Groovy Code](#)
- [Run Groovy Tools](#)
- [Implement Maven Plugins](#)

Advanced:

- [Groovy Runtime](#)
- [Advanced Configuration](#)

Licensed under the [Apache License v2.0](#).

Releases



PRE-RELEASE SOFTWARE

No release has yet been made, please use version `1.0-beta-4-SNAPSHOT` to test the current pre-release.

Latest Release

- [GMaven - 1.0-beta-4 Release](#)

All Releases

- [GMaven - 1.0-beta-4 Release](#)

Support

Mailing Lists

GMaven uses the standard [Groovy mailing lists](#) for discussion and support. To help us respond faster please prefix email subjects with [GMaven] 😊

Click [here](#) to ask for help. Or, *maybe better* create an issue in our [tracking system](#) with all of the details related to your question/problem. We promise to look at them... honest... of course bribes always help motivate us (er me) :-P

Issue Tracking

Project Lead:

Reports: [Open Issues](#) | [Road Map](#) | [Change Log](#) | [Popular Issues](#) | [Versions](#) | [Components](#)

Open Issues: (By Priority) - - - -

Filter Issues:

- [All](#)
- [Outstanding](#)
- [Unscheduled](#)
- [Most important](#)
- [Resolved recently](#)
- [Added recently](#)
- [Updated recently](#)

Components

Total Issues: 15 Statistics: [Maven 2.x Groovy Integration](#) (Components)

 build	4	27%
 compile	2	13%
 execute	2	13%
 stub generation	5	33%
 testCompile	2	13%
No component	3	20%

Upcoming Releases

Road Map: **Next 90 Days** (Until 22/Jul/08)

 [Maven 2.x Groovy Integration](#) : [1.0-beta-4](#) 19/Apr/08
2008-04-19T00-00

26 of 32 issues resolved

Recent Issues

 jira.codehaus.org
(An XML representation of a search request)

- [\[MGROOVY-133\] Use new stub-generation for 1.0 runtime](#)
- [\[MGROOVY-132\] Use new stub-generation for 1.5 runtime](#)
- [\[MGROOVY-131\] Upgrade to Groovy 1.5.5](#)

Source Code

The source-code for GMaven is available for browsing [here](#).

Users who wish to check-out the latest version can access the development branch with [Subversion](#):

svn co https://svn.codehaus.org/groovy/gmaven/trunk

Recent Changes



[FishEye on groovy/gmaven](#)

(Recent changes to the "groovy" repository under directory /gmaven)

[root: user57: For sanity](#)

[root: user57: Remote duplicate config](#)

[root: user57: Fixed url](#)

[root: user57: Add ciManagement config](#)

[root: user57: Add some helpers to clean up code](#)

Continuous Integration

[Builds](#)



[Bamboo build results feed for the Gmaven Trunk - Java 5 build](#)

(This feed is updated whenever the Gmaven Trunk - Java 5 build gets built)

[GMAVEN-GMVN-5 was SUCCESSFUL \(with 24 tests\): Updated by user57](#)

[GMAVEN-GMVN-4 was SUCCESSFUL \(with 24 tests\): Updated by user57](#)

[GMAVEN-GMVN-3 was SUCCESSFUL \(with 20 tests\): Manual build by user57](#)

[GMAVEN-GMVN-2 has FAILED : Initial clean build](#)

GMaven - Advanced Configuration

This page last changed on Apr 07, 2008 by [user57](#).

For advanced users, some tweakable bits for those who like to flip switches.

- [Logging Configuration](#)

Logging Configuration

GMaven uses [SLF4j](#) and uses the *Gossip* provider to allow for simple and flexible configuration of logging output.

By default Gossip will use a reasonable default configuration. But if you feel like Maven is not spitting out enough information, or want to target the information displayed.

Try creating a `$(HOME)/.gossip/config.properties` file something like this:

```
version=1.0

profiles=groovy-debug

profile.groovy-debug.triggers=debug

profile.groovy-
debug.trigger.debug=org.codehaus.groovy.maven.gossip.model.trigger.SystemPropertyTrigger
profile.groovy-debug.trigger.debug.name=groovy-debug

profile.groovy-debug.filters=console

profile.groovy-debug.filter.console=org.codehaus.groovy.maven.gossip.model.filter.ConsoleWriter
profile.groovy-
debug.filter.console.renderer=org.codehaus.groovy.maven.gossip.model.render.SimpleRenderer
profile.groovy-debug.filter.console.renderer.includeName=true
profile.groovy-debug.filter.console.renderer.shortName=true
profile.groovy-debug.filter.console.renderer.nameWidth=30

profile.groovy-debug.logger.org.codehaus.groovy.maven=DEBUG
```

And then flip it on by setting the `groovy-debug` property. Try it with the `groovy:providers` goal and see what it spits up.

```
mvn groovy:providers -Dgroovy-debug
```

GMaven - Building Groovy Projects

This page last changed on Apr 08, 2008 by user57.

GMaven has *kick-ass* support for compiling Groovy projects with Maven!

- [Project Structure](#)
- [gmaven-archetype-basic Archetype](#)
- [Compiling Sources](#)
 - [Source Selection](#)
 - [Compilation Flags](#)
- [Stub-Generation](#)
- [Running Tests](#)
- [groovy-jar Packaging](#)

Project Structure

Groovy projects are structured based on the Maven standard, notably adding the `groovy` sub-directory to the `main` and `test` source collections:

```
<project-root>/
|
+- pom.xml
|
+- src/
|  |
|  +- main/
|  |  |
|  |  +- groovy/ (source location for Groovy and optional Java sources)
|  |  |
|  |  +- test/
|  |  |
|  |  +- groovy/ (source location for Groovy and optional Java test sources)
|  |  |
...

```

gmaven-archetype-basic Archetype

To help get Groovy projects started faster, you can use the `gmaven-archetype-basic`. This will create a new project with the basic POM configuration and some example classes to get you started quickly:

```
mvn archetype:generate -DarchetypeGroupId=org.codehaus.groovy.maven.archetypes -
DarchetypeArtifactId=gmaven-archetype-basic
```



TIP

To use a specific version of an archetype specify `-DarchetypeVersion=<VERSION>`.

The [Maven Archetype Plugin](#) will ask a few questions about your new project:

```
[INFO] [archetype:generate]
...
Define value for groupId: : org.mycompany.myproject
Define value for artifactId: : example-project
Define value for version: : 1.0-SNAPSHOT
Define value for package: : org.mycompany.myproject.example
Confirm properties configuration:
name: Example Project
groupId: org.mycompany.myproject
artifactId: example-project
version: 1.0-SNAPSHOT
package: org.mycompany.myproject.example
Y: : y
```

```
...
[INFO] -----
[INFO] BUILD SUCCESSFUL
[INFO] -----
...
```



NOTE

Please ignore any `ReferenceException` warnings about `$$...`, they are harmless.

The above example would have created the following project structure:

```
example-project
example-project/pom.xml
example-project/src
example-project/src/main
example-project/src/main/groovy
example-project/src/main/groovy/org
example-project/src/main/groovy/org/mycompany
example-project/src/main/groovy/org/mycompany/myproject
example-project/src/main/groovy/org/mycompany/myproject/example
example-project/src/main/groovy/org/mycompany/myproject/example/Example.groovy
example-project/src/main/groovy/org/mycompany/myproject/example/Helper.java
example-project/src/test
example-project/src/test/groovy
example-project/src/test/groovy/org
example-project/src/test/groovy/org/mycompany
example-project/src/test/groovy/org/mycompany/myproject
example-project/src/test/groovy/org/mycompany/myproject/example
example-project/src/test/groovy/org/mycompany/myproject/example/ExampleTest.groovy
example-project/src/test/groovy/org/mycompany/myproject/example/HelperTest.groovy
```

Compiling Sources

GMaven provides support to compile Groovy sources, which includes joint Java/Groovy compilation via stub-generation.

To enable compilation features configure the `gmaven-plugin` execute the stub-generation and compilation goals in your projects POM and define a dependency on the Groovy runtime your project requires (using the `default` version in this example:

```
<dependencies>
<dependency>
<groupId>org.codehaus.groovy.maven.runtime</groupId>
<artifactId>gmaven-runtime-default</artifactId>
</dependency>
</dependencies>

<build>
<plugins>
<plugin>
<groupId>org.codehaus.groovy.maven</groupId>
<artifactId>gmaven-plugin</artifactId>
<executions>
<execution>
<goals>
<goal>generateStubs</goal>
<goal>compile</goal>
<goal>generateTestStubs</goal>
<goal>testCompile</goal>
</goals>
</execution>
</executions>
</plugin>
```



```
</plugins>
</build>
```

Source Selection

By default, all *.groovy files under `src/main/groovy` will be compiled into `target/classes` and all *.groovy files under `src/test/groovy` will be compiled into `target/test-classes`.

To use a more specific list of sources, specify one or more source filesets. When sources is specified the default location is not automatically included:

```
<plugin>
<groupId>org.codehaus.groovy.maven</groupId>
<artifactId>gmaven-plugin</artifactId>
<executions>
<execution>
<goals>
<goal>compile</goal>
</goals>
<configuration>
<sources>
<fileset>
<directory>${pom.basedir}/src/main/script</directory>
<includes>
<include>**/*.groovy</include>
</includes>
</fileset>
</sources>
</configuration>
</execution>
</executions>
</plugin>
```

Compilation Flags

Many of the options available in the Groovy compiler configuration can also be set:

```
<plugin>
<groupId>org.codehaus.groovy.maven</groupId>
<artifactId>gmaven-plugin</artifactId>
<configuration>
<debug>>false</debug>
<verbose>>true</verbose>
<stacktrace>>true</stacktrace>
<defaultScriptExtension>.groovy</defaultScriptExtension>
</configuration>
</plugin>
```



TODO

Link to the generated plugin documentation for reference to all configuration/flags.

Stub-Generation

Stub-generation creates minimal Java sources for each Groovy class preserving the class structure and Javadocs, but omitting implementation detail. This allows the standard [Maven Compiler Plugin](#) to be used to compile Java sources which have a dependency upon Groovy sources with out any additional POM configuration or magical hacks.

Stub class files are used for resolving classes at compile-time, at runtime the compiled Groovy classes will be used instead.

Stub source files are used for generating API documentation via the standard [Maven Javadoc Plugin](#), other plugins which operate on source files (ex. [Maven JXR Plugin](#)) will also utilize these generated source files for reports.

Running Tests

Test execution works just like any normal Maven project using the [Maven Surefire Plugin](#). Using the `testCompile` goal, the GMaven plugin will compile Groovy sources into Java class files, which the Surefire plugin will execute just like any other Java class.

Be sure to configure your project's to depend on the required Groovy runtime and the desired unit-testing library (using `junit3` in this example):

```
<dependencies>
<dependency>
<groupId>org.codehaus.groovy.maven.runtime</groupId>
<artifactId>gmaven-runtime-default</artifactId>
<scope>test</scope>
</dependency>

<dependency>
<groupId>junit</groupId>
<artifactId>junit</artifactId>
<scope>test</scope>
</dependency>
</dependencies>
```

Non-Groovy projects can still make use of Groovy for testing... which can make for less verbose test classes 😊

groovy-jar Packaging

 **TODO**
TODO

GMaven - Executing Groovy Code

This page last changed on Apr 08, 2008 by [user57](#).

Executing Groovy code from Maven is a snap with GMaven.

Groovy source can be configured inline from POM configuration, or from an external file or URL source, have additional property configuration, better defaults and well just makes you feel happy 😊

- [Default Variables](#)
- [Examples](#)
 - [Execute an *Inline* Groovy Script](#)
 - [Execute a *Local* Groovy Script](#)
 - [Execute a *Remote* Groovy Script](#)
- [Class Dependencies](#)
 - [Using *Java* Classes](#)
 - [Using *Groovy* Classes](#)
- [Custom Properties](#)
- [Script Helpers](#)
 - [Using *fail\(\)*](#)
- [Resources](#)
 - [Groovy Development](#)

Default Variables

By default a few variables are bound into the scripts environment:

project	The maven project, with auto-resolving properties
pom	Alias for <i>project</i>
session	The executing <code>MavenSession</code>
settings	The executing <code>Settings</code>
log	A SLF4J Logger instance
ant	An <code>AntBuilder</code> instance for easy access to Ant tasks
fail()	A helper to throw <code>MojoExecutionException</code>

Examples

Execute an *Inline* Groovy Script

```
<plugin>
<groupId>org.codehaus.groovy.maven</groupId>
<artifactId>gmaven-plugin</artifactId>
<executions>
<execution>
<phase>generate-resources</phase>
<goals>
<goal>execute</goal>
</goals>
<configuration>
<source>
if (project.packaging != 'pom') {
log.info('Copying some stuff...')
}
```

```

def dir = new File(project.basedir, 'target/classes/META-INF')

ant.mkdir(dir: dir)
ant.copy(todir: dir) {
  fileset(dir: project.basedir) {
    include(name: 'LICENSE.txt')
    include(name: 'NOTICE.txt')
  }
}
</source>
</configuration>
</execution>
</executions>
</plugin>

```

Execute a *Local* Groovy Script

```

<plugin>
<groupId>org.codehaus.groovy.maven</groupId>
<artifactId>gmaven-plugin</artifactId>
<executions>
<execution>
<phase>generate-resources</phase>
<goals>
<goal>execute</goal>
</goals>
<configuration>
<source>${pom.basedir}/src/main/script/myscript.groovy</source>
</configuration>
</execution>
</executions>
</plugin>

```

Execute a *Remote* Groovy Script

```

<plugin>
<groupId>org.codehaus.groovy.maven</groupId>
<artifactId>gmaven-plugin</artifactId>
<executions>
<execution>
<phase>generate-resources</phase>
<goals>
<goal>execute</goal>
</goals>
<configuration>
<source>http://mydomain.com/myscript.groovy</source>
</configuration>
</execution>
</executions>
</plugin>

```

Class Dependencies

Using *Java* Classes

Scripts can use Java classes. To include custom classes to be available to the script define a classpath which contains additional artifacts to included in the scripts classloader.

This is the preferred mechanism to extend a scripts classpath instead of adding dependencies to the plugin, which may cause problems if the classpath needs to be different on more than one plugin execution or when it differs between usage in more than one module in a multi-module build.

Artifact definitions will pick up missing details from the POM's `dependencyManagement` section.

```
<plugin>
<groupId>org.codehaus.groovy.maven</groupId>
<artifactId>gmaven-plugin</artifactId>
<executions>
<execution>
<phase>generate-resources</phase>
<goals>
<goal>execute</goal>
</goals>
<configuration>
<classpath>
<element>
<groupId>commons-lang</groupId>
<artifactId>commons-lang</groupId>
</element>
</classpath>
<source>
import org.apache.commons.lang.SystemUtils
if (SystemUtils.IS_OS_WINDOWS) {
println('Go buy a Mac!')
}
</source>
</configuration>
</execution>
</executions>
</plugin>
```

Using Groovy Classes

By setting the `scriptpath` you can load additional Groovy classes.

For example if you have a class named `Helper` defined in a file named `${pom.basedir}/src/main/script/Helper.groovy` your scripts can use that class:

```
<plugin>
<groupId>org.groovy.mojo.groovy</groupId>
<artifactId>gmaven-plugin</artifactId>
<executions>
<execution>
<phase>generate-resources</phase>
<goals>
<goal>execute</goal>
</goals>
<configuration>
<scriptpath>
<element>${pom.basedir}/src/main/script</element>
</scriptpath>
<source>
import Helper
Helper.callSomeStatic()
</source>
</configuration>
</execution>
</executions>
</plugin>
```

Custom Properties

By setting the `properties` parameter additional project properties can be added for an execution.

Properties will automatically resolve when accessed. This means that if you have defined a property with a value of `${session}` that when you access it from your script, the returned value will be the `{MavenSession}` instance, just as one would expect when using `@parameter expression="${session}"` in a Mojo annotation. Though as noted below, default values are handled slightly differently than what is done currently for Mojo annotations.



WARNING

Property expressions are **not** GStrings, they are Maven expressions. You need to use the `${foo}` syntax for them, `$foo` will **not** work.

Because of this property resolution, the value of a property might not be a String as one might expect when talking about normal Java properties. But, just for us Groovy doesn't really care what the type is.

```
<plugin>
<groupId>org.codehaus.groovy.maven</groupId>
<artifactId>gmaven-plugin</artifactId>
<executions>
<execution>
<phase>generate-resources</phase>
<goals>
<goal>execute</goal>
</goals>
<configuration>
<properties>
<hello>world</hello>
</properties>
<source>
println project.properties['hello']

// or if you prefer, these work just the same:
// println project.properties.hello
// println project.properties.get('hello')
// println project.properties.getProperty('hello')
</source>
</configuration>
</execution>
</executions>
</plugin>
```

By setting defaults additional project properties can be added for an execution which will be used only if the project or system does not override.

```
<plugin>
<groupId>org.codehaus.groovy.maven</groupId>
<artifactId>gmaven-plugin</artifactId>
<executions>
<execution>
<phase>generate-resources</phase>
<goals>
<goal>execute</goal>
</goals>
<configuration>
<defaults>
<hello>world</hello>
</defaults>
<source>
println project.properties['hello']
</source>
</configuration>
```

```
</execution>
</executions>
</plugin>
```

To provide a system override:

```
mvn -Dhello=jason
```

Script Helpers

Using `fail()`

Sometimes executed Groovy scripts need to fail the build. To do so without causing evil stack traces or assert expressions to get spat out, you need to throw a `MojoExecutionException`. To help make this a little bit easier there is a `fail()` closure bound to the default namespace for the executed script.

Failing with a simple string:

```
fail("That ain't no woman! It's a man, man!")
```

Failing with an exception detail:

```
try {
  ....
}
catch (Exception e) {
  fail(e)
}
```

Failing with an exception detail and a message:

```
try {
  ....
}
catch (Exception e) {
  fail("She's the village bicycle! Everybody's had a ride.", e)
}
```

Resources

Groovy Development

- [Using Ant from Groovy](#)
- [Ant User Manual](#)
- [Groovy JDK Methods](#)
- [Groovy Javadocs](#)

GMaven - Groovy Runtime

This page last changed on Apr 08, 2008 by [user57](#).

GMaven uses an abstraction layer to access a specific version of the Groovy language runtime.

This allows builds to work with different Groovy versions without much fuss.

- [Features](#)
- [Providers](#)
- [Runtime Selection](#)
- [Provider Information](#)
- [Custom Versions](#)

The abstraction layer consists of a runtime *provider* implementation which exposes a set of *features*.

Features

- Class Loading
- Class Compilation
- Stub Compilation
- Script Execution
- Command-line Shell (ie. [Groovy Shell](#))
- GUI Console (ie. [Groovy Console](#))
- Stack Trace Sanitization



TODO

Document which goals require which features.

Providers

	1.0	1.5
Class Loading		
Class Compilation		
Stub Compilation		
Script Execution		
Command-line Shell		
GUI Console		
Stack Trace Sanitization		

Default Provider	Supported	Unsupported	Partial/Crippled Support	Unknown
------------------	-----------	-------------	--------------------------	---------

Runtime Selection

The selection of which Groovy runtime will be used is primarily controlled by the `groovy.runtime.provider` property.

For example, to use the Groovy 1.5 runtime:

```
mvn -Dgroovy.runtime.provider=1.5 install
```

To always use the latest supported runtime the `default` provider key can be used:

```
mvn -Dgroovy.runtime.provider=default install
```

This property is a comma-separated list of runtime provider keys, which will be used in the order in which they are listed. So in the example below, first the 1.5 runtime will be queried for availability (and support), then the 1.0 provider and then finally the `default` provider will be used.

```
mvn -Dgroovy.runtime.provider=1.5,1.0,default install
```

Provider Information

Sometimes it helps to see what providers are configured. Use the `groovy:providers` goal to show some details about the discovered providers as well as which is selected based on the current execution environment.

```
mvn groovy:providers
```

This should split up some details about the providers like:

```
[INFO] [groovy:providers]
[INFO]
[INFO] Provider selection: default
[INFO]
[INFO] Found 2 registered providers:
[INFO]   [1.5] 'Groovy v1.5.1' (version: 1.5.1, type:
org.codehaus.groovy.maven.runtime.v15.GroovyRuntime_v15)
[INFO]     Features:
[INFO]       org.codehaus.groovy.maven.runtime.Console
[INFO]       org.codehaus.groovy.maven.runtime.ClassFactory
[INFO]       org.codehaus.groovy.maven.runtime.TraceSanitizer
[INFO]       org.codehaus.groovy.maven.runtime.StubCompiler
[INFO]       org.codehaus.groovy.maven.runtime.ClassCompiler
[INFO]       org.codehaus.groovy.maven.runtime.Shell
[INFO]       org.codehaus.groovy.maven.runtime.ScriptExecutor
[INFO]
[INFO]   [default] 'Groovy v1.5.1' (version: 1.5.1, type:
org.codehaus.groovy.maven.runtime.vdefault.DefaultGroovyRuntime)
[INFO]     Features:
[INFO]       org.codehaus.groovy.maven.runtime.Console
[INFO]       org.codehaus.groovy.maven.runtime.ClassFactory
[INFO]       org.codehaus.groovy.maven.runtime.TraceSanitizer
[INFO]       org.codehaus.groovy.maven.runtime.StubCompiler
[INFO]       org.codehaus.groovy.maven.runtime.ClassCompiler
[INFO]       org.codehaus.groovy.maven.runtime.Shell
[INFO]       org.codehaus.groovy.maven.runtime.ScriptExecutor
[INFO]
[INFO] Selected provider:
[INFO]   [default] 'Groovy v1.5.1' (version: 1.5.1, type:
org.codehaus.groovy.maven.runtime.vdefault.DefaultGroovyRuntime)
[INFO]
```

To test a configuration set the `groovy.runtime.provider` property and see what it produces:

```
mvn groovy:providers -Dgroovy.runtime.provider=1.5,1.0,default
```

Which may spit out something like this:

```
[INFO] [groovy:providers]
[INFO]
[INFO] Provider selection: 1.5,1.0,default
[INFO]
[INFO] Found 3 registered providers:
[INFO] [1.5] 'Groovy v1.5.1' (version: 1.5.1, type:
org.codehaus.groovy.maven.runtime.v15.GroovyRuntime_v15)
[INFO] Features:
[INFO] org.codehaus.groovy.maven.runtime.Console
[INFO] org.codehaus.groovy.maven.runtime.ClassFactory
[INFO] org.codehaus.groovy.maven.runtime.TraceSanitizer
[INFO] org.codehaus.groovy.maven.runtime.StubCompiler
[INFO] org.codehaus.groovy.maven.runtime.ClassCompiler
[INFO] org.codehaus.groovy.maven.runtime.Shell
[INFO] org.codehaus.groovy.maven.runtime.ScriptExecutor
[INFO]
[INFO] [1.0] 'Groovy v1.0' (version: 1.0.0, type:
org.codehaus.groovy.maven.runtime.v10.GroovyRuntime_v10)
[INFO] Features:
[INFO] org.codehaus.groovy.maven.runtime.Console
[INFO] org.codehaus.groovy.maven.runtime.ClassFactory
[INFO] org.codehaus.groovy.maven.runtime.TraceSanitizer
[INFO] org.codehaus.groovy.maven.runtime.StubCompiler
[INFO] org.codehaus.groovy.maven.runtime.ClassCompiler
[INFO] org.codehaus.groovy.maven.runtime.Shell
[INFO] org.codehaus.groovy.maven.runtime.ScriptExecutor
[INFO]
[INFO] [default] 'Groovy v1.5.1' (version: 1.5.1, type:
org.codehaus.groovy.maven.runtime.vdefault.DefaultGroovyRuntime)
[INFO] Features:
[INFO] org.codehaus.groovy.maven.runtime.Console
[INFO] org.codehaus.groovy.maven.runtime.ClassFactory
[INFO] org.codehaus.groovy.maven.runtime.TraceSanitizer
[INFO] org.codehaus.groovy.maven.runtime.StubCompiler
[INFO] org.codehaus.groovy.maven.runtime.ClassCompiler
[INFO] org.codehaus.groovy.maven.runtime.Shell
[INFO] org.codehaus.groovy.maven.runtime.ScriptExecutor
[INFO]
[INFO] Selected provider:
[INFO] [1.5] 'Groovy v1.5.1' (version: 1.5.1, type:
org.codehaus.groovy.maven.runtime.v15.GroovyRuntime_v15)
[INFO]
```

Custom Versions



WARNING

This section needs to be updated... mostly correct though.

Custom versions of Groovy can be used if needed. Simply include a similar provider as a dependency, exclude the dependencies which need to be changed, then add them as dependencies.

Below is an example of using the 1.5 provider and configuring the provider to actually use Groovy 1.1-beta-3.

```
<dependencies>
<dependency>
<groupId>org.codehaus.groovy.maven.runtime</groupId>
<artifactId>gmaven-runtime-1.5</artifactId>
<version>1.0-beta-3</version>
<exclusions>
<exclusion>
```

```

<groupId>org.codehaus.groovy</groupId>
<artifactId>groovy-all-minimal</artifactId>
</exclusion>
</exclusions>
</dependency>

<dependency>
<groupId>org.codehaus.groovy</groupId>
<artifactId>groovy-all-minimal</artifactId>
<version>1.1-beta-3</version>
</dependency>
</dependencies>

<build>
<plugins>
<plugin>
<groupId>org.codehaus.groovy.maven</groupId>
<artifactId>gmaven-plugin</artifactId>
<version>1.0-beta-3</version>

<dependencies>
<dependency>
<groupId>org.codehaus.groovy.maven.runtime</groupId>
<artifactId>gmaven-runtime-1.5</artifactId>
<version>1.0-beta-3</version>
</dependency>

<dependency>
<groupId>org.codehaus.groovy</groupId>
<artifactId>groovy-all-minimal</artifactId>
<version>1.1-beta-3</version>
</dependency>
</dependencies>

<configuration>
<providerSelection>1.5</providerSelection>
</configuration>
</plugin>
</plugins>
</build>

```



NOTE

Be aware that the `providers` key will **not** change; the custom provider is still configured with a selection of 1.5.

If you end up needing a specific version of Groovy then you might be better off rolling your own provider model, and put all the dependency overrides in one place. Don't worry, in most cases you can use the provider/feature implementations from a supported provider and just customize the Groovy (and related) dependencies.

GMaven - Implementing Maven Plugins

This page last changed on Apr 08, 2008 by user57.

Implementing Maven plugins has never been Groovier!

- [Groovy Mojos](#)
- - [A Simple Groovy Mojo](#)
- [Building Plugins](#)
- - [Project Definition](#)
 - [Mojo Parameters](#)
- [Putting More Groove into your Mojo](#)
- - [Using ant](#)
 - [Using fail\(\)](#)
- [gmaven-archetype-mojo Archetype](#)
- [gmaven-plugin Packaging](#)
- [Resources](#)
- - [Mojo Development](#)
 - [Groovy Development](#)

Groovy Maven plugins are very similar to Java Maven plugins. Actually a Groovy Maven plugin is compiled into Java byte-code, and once built, Maven can not tell the difference between a plugin which has been implemented in Java or Groovy.

For the most part, the existing guide for [Developing Maven plugins with Java](#) will also apply to developing plugins with Groovy. There are some differences though, which are covered here which can make Maven plugin development with Groovy better, faster, stronger 😊

Be sure to read over the documentation for [Building Groovy Projects](#). A Groovy Maven plugin is a Groovy project, so most of the information there is relevant here as well.

Groovy Mojos

Just like Java-based Mojo's at its simplest, a Groovy Mojo consists of a single class. For more complicated plugins you are free to use as many classes as needed of course, just like Java... and you can even write Java classes too if you need too.

Groovy Mojo implementations are denoted by the `@goal` Javadoc annotation on the class (er, just like Java). Actually, **all** of the Javadoc annotations which are supported by Java plugins are also supported by Groovy plugins. This is because, when building a Groovy project, the sub-generator spits out Java sources with Javadocs intact, which the [Maven Plugin Plugin](#) then parses for annotations 😊

A Simple Groovy Mojo

Here is our simple Mojo class which has no parameters and spits out a relatively meaningless string via logging:

```
package sample.plugin

import org.codehaus.groovy.maven.mojo.GroovyMojo

/**
 * Says "Hi" to the user... er well not really :-P.
 *
 * @goal sayhi
 */
public class GreetingMojo
extends GroovyMojo
{
void execute() {
log.info('Groovy baby!')
}
}
```

```
}
```

There are a few minor points to note here. First, we are referencing the plugins logger via `log.info()`, where in Java one would need to `getLog().info()`.

Second, there is no need to mark the `execute()` method as throwing any exceptions, though you can still throw any exceptions you need to. You can of course declare what your methods are throwing if you want to.

Lastly, this example mojo extends from `org.codehaus.groovy.maven.mojo.GroovyMojo`, which is recommended for most Groovy mojos. Of course you can always use `org.apache.maven.plugin.AbstractMojo` at the cost of some additional bits of happiness which help make your Mojo's groovier.

Building Plugins

Project Definition

Groovy plugins use the same Java plugin descriptor extractor. The Java extractor uses the generated stubs to build the descriptor, so be sure to invoke the `generateStubs` goal.

Instead of depending on `maven-plugin-api` Groovy plugins depend on `gmaven-mojo`, which picks up the required Maven dependencies and the default Groovy runtime provider.

And of course, we need to hook up the `gmaven-plugin` to compile the Groovy sources into class files (as well as a few others).

Below is a POM for the simple sample groovy mojo:

```
<project>
<modelVersion>4.0.0</modelVersion>
<groupId>sample.plugin</groupId>
<artifactId>maven-hello-plugin</artifactId>
<packaging>maven-plugin</packaging>
<version>1.0-SNAPSHOT</version>
<name>Sample Maven Plugin</name>

<dependencies>
<dependency>
<groupId>org.codehaus.groovy.maven</groupId>
<artifactId>gmaven-mojo</artifactId>
</dependency>
</dependencies>

<build>
<plugins>
<plugin>
<groupId>org.codehaus.groovy.maven</groupId>
<artifactId>gmaven-plugin</artifactId>
<executions>
<execution>
<goals>
<goal>generateStubs</goal>
<goal>compile</goal>
<goal>generateTestStubs</goal>
<goal>testCompile</goal>
</goals>
</execution>
</executions>
</plugin>
</plugins>
</build>
</project>
```



Dependency and Plugin Versions

To use the above example you must configure the `<version>` element for the dependencies and plugins.

Once you have your pom setup then you can build the plugin in the normal way via:

```
mvn install
```

Mojo Parameters

Mojo parameters work **exactly** the same as they do for Java plugins. Simply define a field in your Mojo implementation and annotate the field with a `@parameter` Javadoc tag.

```
/**
 * The greeting to display.
 *
 * @parameter default-value="Groovy baby!"
 */
private String greeting
```

Configuration of Mojo parameters is... as you might expect, the same as with Java Mojos:

```
<plugin>
<groupId>sample.plugin</groupId>
<artifactId>maven-hello-plugin</artifactId>
<configuration>
<greeting>what say, you, we go out on the down and swing, baby? Yea</greeting>
</configuration>
</plugin>
```

The main thing to note about Groovy Mojos and parameters, is that fields should be typed so that Maven (or well, Plexus) can inject objects of the proper type. Using the `def` keyword is the same as typing the field as `Object` which Maven will probably still inject just fine, but it won't perform any conversion.

Putting More Groove into your Mojo

Using ant

Using `ant` allows your Mojo access to any [Ant](#) tasks. Groovy Mojo's which extend from `GroovyMojo` have access to an `AntBuilder` instance bound to the `ant` field. This field is lazily initialized when you first reference it.

Below are some small examples of using `ant` to perform common tasks, but really the sky is the limit on what you can do. See the [Ant User Manual](#) for more tasks you can execute 😊



NOTE

The following examples assume that your Mojo implementation has already defined a project property as in:

```
/**
 * @parameter expression="${project}"
 * @required
 * @readonly
 */
org.apache.maven.project.MavenProject project
```

Touching a File

```
ant.touch(file: "${project.build.directory}/stamp")
```

Copying Files

```
def dir = "${project.build.directory}/backup"
ant.mkdir(dir: dir)
ant.copy(todir: dir) {
  fileset(dir: "${project.build.outputDirectory}") {
    include(name: '**/*')
  }
}
```

Execute Something

```
def propName = 'lsout'
ant.exec(executable: '/bin/ls', outputproperty: propName)
def value = ant.getProject.properties[propName]
```

Using fail()

Most mojos need to report back some failure status, which is normally done by throwing a `MojoExecutionException`. Groovy Mojos can simply invoke the `fail()` method, which handles the details of throwing for you.

Failing with a simple string:

```
fail("That ain't no woman! It's a man, man!")
```

Failing with an exception detail:

```
try {
  ....
}
catch (Exception e) {
  fail(e)
}
```

Failing with an exception detail and a message:

```
try {
  ....
}
catch (Exception e) {
  fail("She's the village bicycle! Everybody's had a ride.", e)
}
```

gmaven-archetype-mojo Archetype

To help get Groovy plugins started faster, you can use the `gmaven-archetype-mojo`. This will create a new project with the basic POM configuration and an example Groovy-based Mojo class to get you started quickly:

```
mvn archetype:generate -DarchetypeGroupId=org.codehaus.groovy.maven.archetypes -
DarchetypeArtifactId=gmaven-archetype-mojo
```



TIP

To use a specific version of an archetype specify `-DarchetypeVersion=<VERSION>`.

The [Maven Archetype Plugin](#) will ask a few questions about your new project:

```
[INFO] [archetype:generate]
...
Define value for groupId: : org.mycompany.myproject
Define value for artifactId: : example-maven-plugin
Define value for version: : 1.0-SNAPSHOT
Define value for package: : org.mycompany.myproject.example
Confirm properties configuration:
name: Example Maven Plugin
groupId: org.mycompany.myproject
artifactId: example-maven-plugin
version: 1.0-SNAPSHOT
package: org.mycompany.myproject.example
Y: : y
...
[INFO] -----
[INFO] BUILD SUCCESSFUL
[INFO] -----
...
```



NOTE

Please ignore any `ReferenceException` warnings about `${...}`, they are harmless.

The above example would have created the following project structure:

```
example-maven-plugin
example-maven-plugin/pom.xml
example-maven-plugin/src
example-maven-plugin/src/main
example-maven-plugin/src/main/groovy
example-maven-plugin/src/main/groovy/org
example-maven-plugin/src/main/groovy/org/mycompany
example-maven-plugin/src/main/groovy/org/mycompany/myproject
example-maven-plugin/src/main/groovy/org/mycompany/myproject/example
example-maven-plugin/src/main/groovy/org/mycompany/myproject/example>HelloMojo.groovy
```

gmaven-plugin Packaging



TODO TODO

Resources

Mojo Development

- [Mojo API specification](#)
- [Guide to Developing Java Plugins](#)

Groovy Development

- [Using Ant from Groovy](#)
- [Ant User Manual](#)
- [Groovy JDK Methods](#)
- [Groovy Javadocs](#)

GMaven - Releases

This page last changed on Apr 07, 2008 by [user57](#).

- [GMaven - 1.0-beta-4 Release](#)

GMaven - 1.0-beta-4 Release

This page last changed on Apr 21, 2008 by user57.



UNRELEASED SOFTWARE

This software has **not** yet been released.

Cannot resolve external resource into attachment.

New and Noteworthy



TODO

Using

Command-line Access

If this release is the *latest*, then simply use the `groovy` prefix to invoke goals, as in:

```
mvn groovy:<goal>
```

Otherwise, use the full plugin identifier to invoke this version:

```
mvn org.codehaus.groovy.maven:gmvaven-plugin:1.0-beta-4:<goal>
```

Project Configuration

When configuring projects to use this plugin be sure to define elements in your projects top-level POM's `pluginManagement` section to bind your project to the required version:

```
<project>
<dependencyManagement>
<dependency>
<groupId>org.codehaus.groovy.maven</groupId>
<artifactId>gmvaven-mojo</artifactId>
<version>1.0-beta-4</version>
</dependency>
<dependency>
<groupId>org.codehaus.groovy.maven.runtime</groupId>
<artifactId>gmvaven-runtime-default</artifactId>
<version>1.0-beta-4</version>
</dependency>
</dependencyManagement>
<build>
<pluginManagement>
<plugins>
<plugin>
<groupId>org.codehaus.groovy.maven</groupId>
<artifactId>gmvaven-plugin</artifactId>
<version>1.0-beta-4</version>
</plugin>
</plugins>
</pluginManagement>
</build>
</project>
```



Best Practice

It is **highly** recommended that you **always** bind, via `pluginManagement` the version of plugins which your build depends upon. or with `dependencyManagement` for versions of artifacts.





























Source Code

The source-code for this release is available for browsing [here](#).









Users who wish to check-out this version can access the release tag with [Subversion](#):

```
svn co https://svn.codehaus.org/groovy/gmaven/tags/gmaven-1.0-rc1
```

Change Log

 jira.codehaus.org (32 issues)					
T	Key	Summary	Pr	Status	Res
	MGROOVY-126	Stub generation causes duplicate class problems for goals like idea:idea		 Open	UNRESOLVED
	MGROOVY-119	Update dependencies used by SHITTY tests		 Open	UNRESOLVED
	MGROOVY-106	Compile errors that occur during stub generation don't give location information		 Open	UNRESOLVED
	MGROOVY-127	Test sources under src/main/groovy do not get added to projects with mvn idea:idea		 Open	UNRESOLVED
	MGROOVY-85	Clean up dependencies, add exclusions for deps which pull in unwanted muck		 Open	UNRESOLVED
	MGROOVY-131	Upgrade to Groovy 1.5.5		 Open	UNRESOLVED
	MGROOVY-125	Stub generator does not allow for overloaded methods		 Closed	FIXED
	MGROOVY-118	Re-implement archetypes based on latest NG bits		 Closed	FIXED
	MGROOVY-130	Re-implement stub-generation bits to allow more code to be		 Closed	FIXED

		shared between runtime versions				
	MGROOVY-114	Support static import for stub generation	↑		Closed	FIXED
	MGROOVY-104	Some weirdness with stubs and constructors.	↑		Closed	FIXED
	MGROOVY-96	Upgrade cobertura-maven-plugin to 2.2	↑		Closed	FIXED
	MGROOVY-133	Use new stub-generation for 1.0 runtime	↑		Closed	FIXED
	MGROOVY-132	Use new stub-generation for 1.5 runtime	↑		Closed	FIXED
	MGROOVY-129	duplicate setter generated in stub	↑		Closed	FIXED
	MGROOVY-128	static member variables not correctly handled by stub generator	↑		Closed	FIXED
	MGROOVY-124	Move non-essential support classes from gmaven-mojo to gmaven-mojo-support	↑		Closed	FIXED
	MGROOVY-122	Drop GroovyMojoSupport	↑		Closed	FIXED
	MGROOVY-120	Create module for holding custom packagings	↑		Closed	FIXED
	MGROOVY-116	Upgrade to Maven Plugin Tools 2.4.1	↑		Closed	FIXED
	MGROOVY-113	Upgrade to Groovy 1.5.4	↑		Closed	FIXED
	MGROOVY-111	Stub generation does not build implied getter/setter methods	↑		Closed	DUPLICATE
	MGROOVY-107	\n in javadocs cause weirdness	↑		Closed	WON'T FIX
	MGROOVY-105	Expose ExecuteMojo in script's execution context	↑		Closed	FIXED
	MGROOVY-103	Vanilla project from archetype doesn't compile	↑		Closed	FIXED
	MGROOVY-102	Getters/Setters should be generated for properties.	↑		Closed	FIXED
	MGROOVY-101	src/main/groovy folder is missing	↑		Closed	FIXED
	MGROOVY-38	Upgrade to Groovy 1.5.1	↑		Closed	FIXED

	MGROOVY-115	Upgrade to SLF4J 1.5.0 ↓		Closed	FIXED
	MGROOVY-112	Drop Groovy 1.1 runtime support ↓		Closed	FIXED
	MGROOVY-87	Update the archetype bits to use the new archetypeng muck ↓		Closed	DUPLICATE
	MGROOVY-123	Put generated stubs into the standard generated-sources directory ↓		Closed	FIXED

GMaven - Running Groovy Tools

This page last changed on Apr 07, 2008 by [user57](#).

If you already have Maven installed, then GMaven is the *quickest* path to running some Groovy tools!

- [Groovy Shell](#)
- [Groovy Console](#)

Groovy Shell

Provides very convenient command-line access to the Groovy language:

```
mvn groovy:shell
```

Which should look something like this:

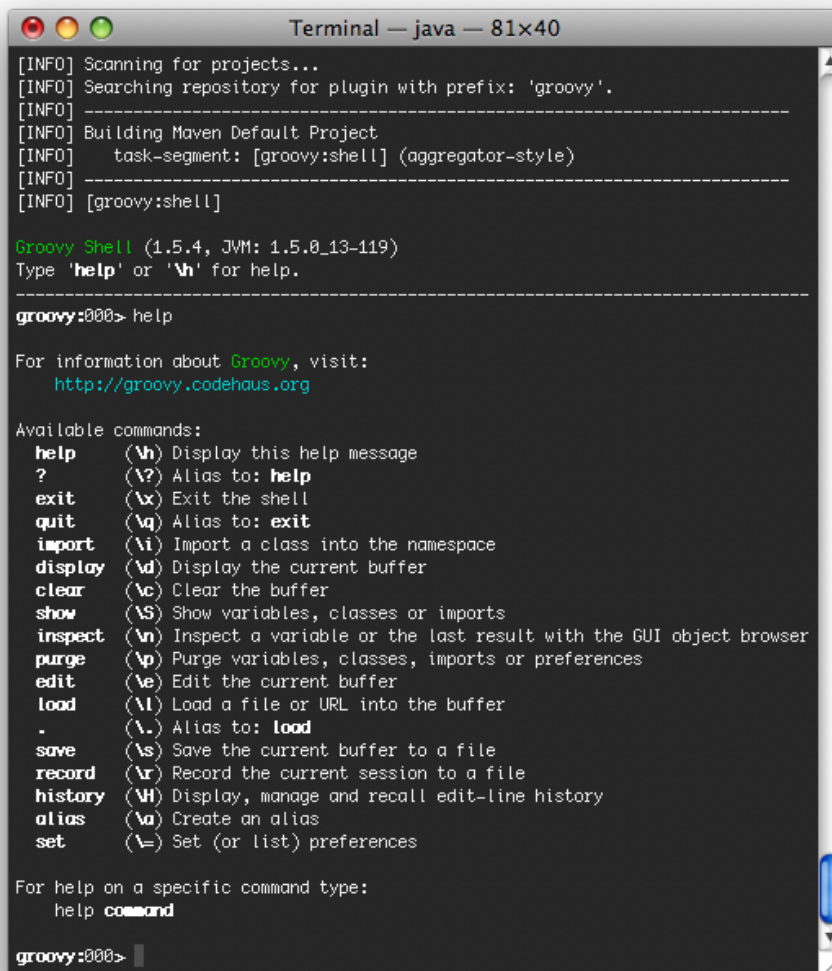
A screenshot of a terminal window titled "Terminal — java — 81x40". The terminal shows the output of the command 'mvn groovy:shell'. It starts with several [INFO] messages: "Scanning for projects...", "Searching repository for plugin with prefix: 'groovy'.", "Building Maven Default Project", "task-segment: [groovy:shell] (aggregator-style)", and "[groovy:shell]". Below these, it displays "Groovy Shell (1.5.4, JVM: 1.5.0_13-119)" and "Type 'help' or 'h' for help.". The prompt "groovy:000>" is shown, followed by the user typing "help". The terminal then displays a list of available commands and their descriptions, such as "help (h) Display this help message", "exit (x) Exit the shell", "import (i) Import a class into the namespace", etc. At the bottom, it says "For help on a specific command type: help command" and the prompt "groovy:000>".

For more information please see the documentation for [Groovy Shell](#).

Groovy Console

For folks that prefer a GUI over command-line access:

```
mvn groovy:console
```

After running, Maven will spit out something similar to this:

```
[INFO] Scanning for projects...
[INFO] Searching repository for plugin with prefix: 'groovy'.
[INFO] -----
[INFO] Building Maven Default Project
[INFO]    task-segment: [groovy:console] (aggregator-style)
[INFO] -----
[INFO] [groovy:console]
```

And then display the GUI console window, waiting for it to be closed before continuing:

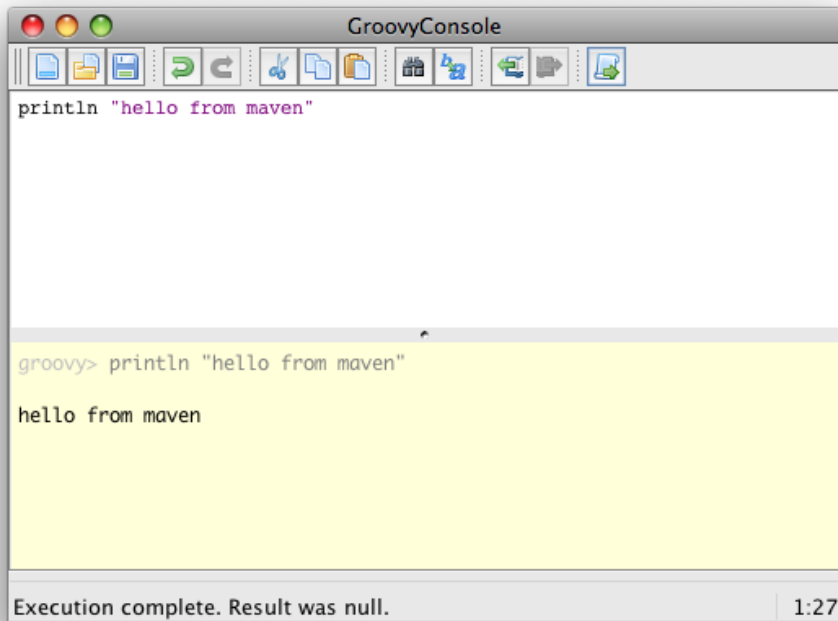

For more information please see the documentation for [Groovy Console](#).

GPath

This page last changed on Dec 28, 2007 by jdf@us.ibm.com.

GPath is a path expression language integrated into Groovy which allows parts of nested structured data to be identified. In this sense, it has similar aims and scope as XPath does for XML. The two main places where you use GPath expressions is when dealing with nested POJOs or when dealing with XML.

As an example, you can specify a path to an object or element of interest:

a.b.c -> for XML, yields all the <c> elements inside inside <a>

a.b.c -> all POJOs, yields the <c> properties for all the properties of <a> (sort of like a.getB().getC() in JavaBeans)

For XML, you can also specify attributes, e.g.:

a["@href"] -> the href attribute of all the a elements

a.'@href' -> an alternative way of expressing this

a.@href -> an alternative way of expressing this when using XmlSlurper

Example

The best example of GPath for xml is test-new/groovy/util/XmlSlurperTest.groovy.

```
package groovy.util

class XmlSlurperTest extends GroovyTestCase {

void testXmlParser() {
def text = ""
<characters>
<props>
<prop>dd</prop>
</props>
<character id="1" name="Wallace">
<likes>cheese</likes>
</character>
<character id="2" name="Gromit">
<likes>sleep</likes>
</character>
</characters>
""

def node = new XmlSlurper().parseText(text);

assert node != null
assert node.children().size() == 3 //, "Children ${node.children()}"

def characters = node.character
println "node:" + node.children().size()
println "characters:" + node.character.size()
for (c in characters) {
println c['@name']
}

assert characters.size() == 2

assert node.character.likes.size() == 2 //, "Likes ${node.character.likes}"

// lets find Gromit
def gromit = node.character.find { it['@id'] == '2' }
assert gromit != null //, "Should have found Gromit!"
assert gromit['@name'] == "Gromit"

// lets find what Wallace likes in 1 query
def answer = node.character.find { it['@id'] == '1' }.likes.text()
assert answer == "cheese"
}
```



```
}
```

Outline

1. Accessing element as property

```
def characters = node.character
def gromit = node.character[1]
```

2. Accessing attributes

```
println gromit['@name']
or
println gromit.@name
```

3. Accessing element body

```
println gromit.likes[0].text()
println node.text()
```

If the element is a father node, it will print all children's text.

3. Explore the DOM use children() and parent()

```
def characters = node.children()
for (c in characters) {
    println c.@name
}
```

4. Find elements use expression

```
def gromit = node.character.find { it.@id == '2' }
```

Another Example

Here is a two line example of how to get a list of all the links to .xml files listed on a web page. The Neko parser is used to parse non-well formed html; it ships as part of the standard Groovy distribution.

```
def myDocument = new XmlParser( new org.cyberneko.html.parsers.SAXParser() ).parse("http://
myUrl.com")
def links = myDocument.depthFirst().A['@href'].findAll{ it.endsWith(".xml") }
```

More Information

See also: [Processing XML](#)

Groovy and JMX

This page last changed on Nov 23, 2007 by [paulk_asert](#).

Introduction

Given that Groovy sits directly on top of Java, Groovy can leverage the tremendous amount of work already done for [JMX](#) with Java. In addition, Groovy provides a `GroovyMBean` class which makes an *MBean* look like a normal Groovy object. This simplifies Groovy code for interacting with MBeans. For example, the following code:

```
println server.getAttribute(beanName, 'Age')
server.setAttribute(beanName, new Attribute('Name', 'New name'))
Object[] params = [5, 20]
String[] signature = [Integer.TYPE, Integer.TYPE]
println server.invoke(beanName, 'add', params, signature)
```

can be simplified to:

```
def mbean = new GroovyMBean(server, beanName)
println mbean.Age
mbean.Name = 'New name'
println mbean.add(5, 20)
```

The remainder of this page shows you how to:

- Monitor the JVM using MXBeans
- Monitor Apache Tomcat and display statistics
- Monitor Oracle OC4J and display information
- Monitor BEA WebLogic and display information
- Leverage Spring's MBean annotation support to export your Groovy beans as MBeans

Note: many of the examples on this page use Java 5 which incorporates JMX 1.2 (more recent versions if JMX or Java will also work). In some cases, you can run some of these examples using Java 1.4 by including a version of JMX on your CLASSPATH. MX4J is bundled with the full distribution of Groovy. In most cases, you can delete this jar from your distribution `lib` directory if you are running with Java 5 or above (in fact you might have to - see the Troubleshooting section below).

Monitoring the JVM

MBeans are not accessed directly by an application but are managed by a repository called an *MBean server*. Java 5 and above includes a special MBean server called the *platform MBean server*, which is built into the JVM. Platform MBeans are registered in this server using unique names.

You can monitor the JVM through its platform MBeans with the following code:

```
import java.lang.management.*

def os = ManagementFactory.operatingSystemMXBean
println ""OPERATING SYSTEM:
\tarchitecture = $os.arch
\tname = $os.name
\tversion = $os.version
\tprocessors = $os.availableProcessors
""

def rt = ManagementFactory.runtimeMXBean
println ""RUNTIME:
\tname = $rt.name
\tspec name = $rt.specName
\tvendor = $rt.specVendor
\tspec version = $rt.specVersion
\tmanagement spec version = $rt.managementSpecVersion
""
```

```

def cl = ManagementFactory.classLoadingMXBean
println ""CLASS LOADING SYSTEM:
\tisVerbose = ${cl.isVerbose()}
\tloadedClassCount = $cl.loadedClassCount
\ttotalLoadedClassCount = $cl.totalLoadedClassCount
\tunloadedClassCount = $cl.unloadedClassCount
""

def comp = ManagementFactory.compilationMXBean
println ""COMPILATION:
\ttotalCompilationTime = $comp.totalCompilationTime
""

def mem = ManagementFactory.memoryMXBean
def heapUsage = mem.heapMemoryUsage
def nonHeapUsage = mem.nonHeapMemoryUsage
println ""MEMORY:
HEAP STORAGE:
\tcommitted = $heapUsage.committed
\tinit = $heapUsage.init
\tmax = $heapUsage.max
\tused = $heapUsage.used
NON-HEAP STORAGE:
\tcommitted = $nonHeapUsage.committed
\tinit = $nonHeapUsage.init
\tmax = $nonHeapUsage.max
\tused = $nonHeapUsage.used
""

ManagementFactory.memoryPoolMXBeans.each { mp ->
println "\tname: " + mp.name
String[] mmnames = mp.memoryManagerNames
mmnames.each { mmname ->
println "\t\tManager Name: $mmname"
}
println "\t\tmtype = $mp.type"
println "\t\tUsage threshold supported = " + mp.isUsageThresholdSupported()
}
println()

def td = ManagementFactory.threadMXBean
println "THREADS:"
td.allThreadIds.each { tid ->
println "\tThread name = ${td.getThreadInfo(tid).threadName}"
}
println()

println "GARBAGE COLLECTION:"
ManagementFactory.garbageCollectorMXBeans.each { gc ->
println "\tname = $gc.name"
println "\t\tcollection count = $gc.collectionCount"
println "\t\tcollection time = $gc.collectionTime"
String[] mpoolNames = gc.memoryPoolNames
mpoolNames.each { mpoolName ->
println "\t\tmpool name = $mpoolName"
}
}
}

```

When run, you will see something like this:

```

OPERATING SYSTEM:
architecture = x86
name = Windows XP
version = 5.1
processors = 2

```

RUNTIME:
name = 620@LYREBIRD
spec name = Java Virtual Machine Specification
vendor = Sun Microsystems Inc.
spec version = 1.0
management spec version = 1.0

CLASS LOADING SYSTEM:
isVerbose = false
loadedClassCount = 919
totalLoadedClassCount = 919
unloadedClassCount = 0

COMPILATION:
totalCompilationTime = 91

MEMORY:
HEAP STORAGE:
committed = 3108864
init = 0
max = 66650112
used = 1994728
NON-HEAP STORAGE:
committed = 9240576
init = 8585216
max = 100663296
used = 5897880

name: Code Cache
Manager Name: CodeCacheManager
mtype = Non-heap memory
Usage threshold supported = true
name: Eden Space
Manager Name: MarkSweepCompact
Manager Name: Copy
mtype = Heap memory
Usage threshold supported = false
name: Survivor Space
Manager Name: MarkSweepCompact
Manager Name: Copy
mtype = Heap memory
Usage threshold supported = false
name: Tenured Gen
Manager Name: MarkSweepCompact
mtype = Heap memory
Usage threshold supported = true
name: Perm Gen
Manager Name: MarkSweepCompact
mtype = Non-heap memory
Usage threshold supported = true

THREADS:
Thread name = Monitor Ctrl-Break
Thread name = Signal Dispatcher
Thread name = Finalizer
Thread name = Reference Handler
Thread name = main

GARBAGE COLLECTION:
name = Copy
collection count = 60
collection time = 141
mpool name = Eden Space
mpool name = Survivor Space
name = MarkSweepCompact
collection count = 0

```
collection time = 0
mpool name = Eden Space
mpool name = Survivor Space
mpool name = Tenured Gen
mpool name = Perm Gen
```

Monitoring Tomcat

First start up [Tomcat](#) with JMX monitoring enabled by setting the following:

```
set JAVA_OPTS=-Dcom.sun.management.jmxremote -Dcom.sun.management.jmxremote.port=9004
-Dcom.sun.management.jmxremote.authenticate=false -Dcom.sun.management.jmxremote.ssl=false
```

You can do this in your startup script and may choose any available port - we used 9004.

The following code uses JMX to discover the available MBeans in the running Tomcat, determine which are web modules, extract the processing time for each web module and displays the result in a graph using JFreeChart:

```
import javax.management.ObjectName
import javax.management.remote.JMXConnectorFactory as JmxFactory
import javax.management.remote.JMXServiceURL as JmxUrl
import org.jfree.chart.ChartFactory
import org.jfree.data.category.DefaultCategoryDataset as Dataset
import org.jfree.chart.plot.PlotOrientation as Orientation
import groovy.swing.SwingBuilder
import javax.swing.WindowConstants as WC

def serverUrl = 'service:jmx:rmi:///jndi/rmi://localhost:9004/jmxrmi'
def server = JmxFactory.connect(new JmxUrl(serverUrl)).mBeanServerConnection
def serverInfo = new GroovyMBean(server, 'Catalina:type=Server').serverInfo
println "Connected to: $serverInfo"

def query = new ObjectName('Catalina:*')
String[] allNames = server.queryNames(query, null)
def modules = allNames.findAll{ name ->
name.contains('j2eeType=WebModule')}
}.collect{ new GroovyMBean(server, it) }

println "Found ${modules.size()} web modules. Processing ..."
def dataset = new Dataset()

modules.each{ m ->
println m.name()
dataset.addValue m.processingTime, 0, m.path
}

def labels = ['Time per Module', 'Module', 'Time']
def options = [false, true, true]
def chart = ChartFactory.createBarChart(*labels, dataset,
Orientation.VERTICAL, *options)
def swing = new SwingBuilder()
def frame = swing.frame(title:'Catalina Module Processing Time',
defaultCloseOperation:WC.EXIT_ON_CLOSE) {
panel(id:'canvas') { rigidArea(width:600, height:250) }
}
frame.pack()
frame.show()
chart.draw(swing.canvas.graphics, swing.canvas.bounds)
```

When run, we will see a trace of progress being made:

```
Connected to: Apache Tomcat/6.0.13
Found 5 web modules. Processing ...
Catalina:j2eeType=WebModule,name=//localhost/,J2EEApplication=none,J2EEServer=none
Catalina:j2eeType=WebModule,name=//localhost/host-manager,J2EEApplication=none,J2EEServer=none
```

```
Catalina:j2eeType=WebModule,name=//localhost/docs,J2EEApplication=none,J2EEServer=none
Catalina:j2eeType=WebModule,name=//localhost/examples,J2EEApplication=none,J2EEServer=none
Catalina:j2eeType=WebModule,name=//localhost/manager,J2EEApplication=none,J2EEServer=none
```

The output will look like this:

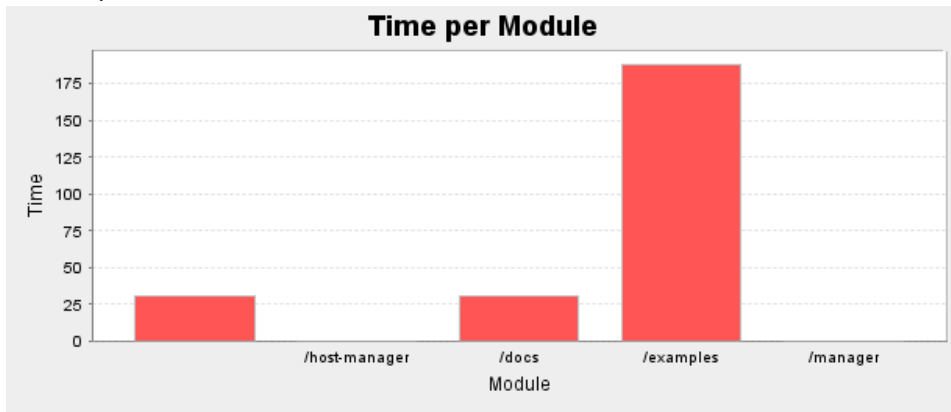

Note: if you get errors running this script, see the **Troubleshooting** section below.

OC4J Example

Here is a script to access [OC4J](#) and print out some information about the server, its runtime and (as an example) the configured JMS destinations:

```
import javax.management.remote.*
import oracle.oc4j.admin.jmx.remote.api.JMXConnectorConstant

def serverUrl = new JMXServiceURL('service:jmx:rmi://localhost:23791')
def serverPath = 'oc4j:j2eeType=J2EEServer,name=standalone'
def jvmPath = 'oc4j:j2eeType=JVM,name=single,J2EEServer=standalone'
def provider = 'oracle.oc4j.admin.jmx.remote'
def credentials = [
(JMXConnectorConstant.CREDENTIALS_LOGIN_KEY): 'oc4jadmin',
(JMXConnectorConstant.CREDENTIALS_PASSWORD_KEY): 'admin'
]
def env = [
(JMXConnectorFactory.PROTOCOL_PROVIDER_PACKAGES): provider,
(JMXConnector.CREDENTIALS): credentials
]
def server = JmxFactory.connect(serverUrl, env).mBeanServerConnection
def serverInfo = new GroovyMBean(server, serverPath)
def jvmInfo = new GroovyMBean(server, jvmPath)
println """Connected to $serverInfo.node. \
Server started ${new Date(serverInfo.startTime)}. \
OC4J version: $serverInfo.serverVersion from $serverInfo.serverVendor \
JVM version: $jvmInfo.javaVersion from $jvmInfo.javaVendor \
Memory usage: $jvmInfo.freeMemory bytes free, \
$jvmInfo.totalMemory bytes total \
"""

def query = new javax.management.ObjectName('oc4j:*')
String[] allNames = server.queryNames(query, null)
def dests = allNames.findAll{ name ->
name.contains('j2eeType=JMSDestinationResource')
}.collect{ new GroovyMBean(server, it) }

println "Found ${dests.size()} JMS destinations. Listing ..."
dests.each{ d -> println "$d.name: $d.location" }
```

Here is the result of running this script:

Connected to LYREBIRD. Server started Thu May 31 21:04:54 EST 2007.
OC4J version: 11.1.1.0.0 from Oracle Corp.
JVM version: 1.6.0_01 from Sun Microsystems Inc.
Memory usage: 8709976 bytes free, 25153536 bytes total

Found 5 JMS destinations. Listing ...
Demo Queue: jms/demoQueue
Demo Topic: jms/demoTopic
jms/Oc4jJmsExceptionQueue: jms/Oc4jJmsExceptionQueue
jms/RAExceptionQueue: jms/RAExceptionQueue
OracleASRouter_store: OracleASRouter_store

As a slight variation, this script displays a pie chart of memory usage using JFreeChart:

```
import org.jfree.chart.ChartFactory
import javax.swing.WindowConstants as WC
import javax.management.remote.*
import oracle.oc4j.admin.jmx.remote.api.JMXConnectorConstant

def url = 'service:jmx:rmi://localhost:23791'
def credentials = [:]
credentials[JMXConnectorConstant.CREDENTIALS_LOGIN_KEY] = "oc4jadmin"
credentials[JMXConnectorConstant.CREDENTIALS_PASSWORD_KEY] = "password"
def env = [:]
env[JMXConnectorFactory.PROTOCOL_PROVIDER_PACKAGES] = "oracle.oc4j.admin.jmx.remote"
env[JMXConnector.CREDENTIALS] = credentials
def server = JMXConnectorFactory.connect(new JMXServiceURL(url), env).mBeanServerConnection
def jvmInfo = new GroovyMBean(server, 'oc4j:j2eeType=JVM,name=single,J2EEServer=standalone')

def piedata = new org.jfree.data.general.DefaultPieDataset()
piedata.setValue "Free", jvmInfo.freeMemory
piedata.setValue "Used", jvmInfo.totalMemory - jvmInfo.freeMemory

def options = [true, true, true]
def chart = ChartFactory.createPieChart('OC4J Memory Usage', piedata, *options)
chart.setBackgroundPaint = java.awt.Color.white
def swing = new groovy.swing.SwingBuilder()
def frame = swing.frame(title:'OC4J Memory Usage', defaultCloseOperation:WC.EXIT_ON_CLOSE) {
panel(id:'canvas') { rigidArea(width:350, height:250) }
}
frame.pack()
frame.show()
chart.draw(swing.canvas.graphics, swing.canvas.bounds)
```

Which looks like:

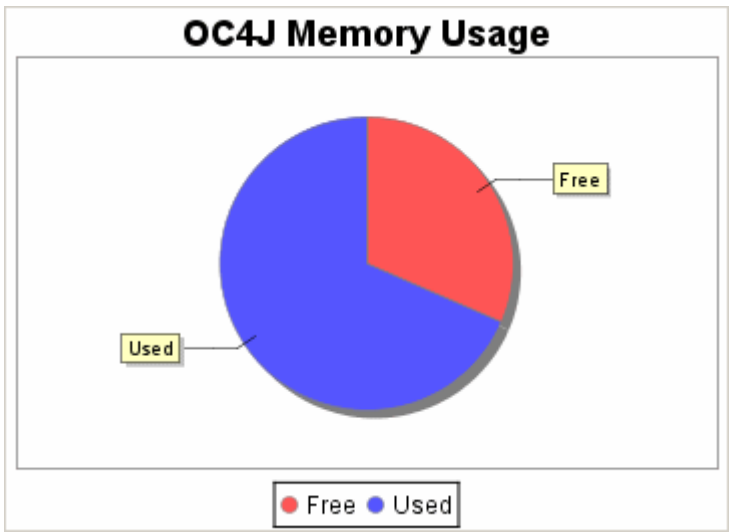

WebLogic Example

This script prints out information about the server followed by information about JMS Destinations (as an example). Many other mbeans are [available](#).

```
import javax.management.remote.*
import javax.management.*
import javax.naming.Context

def urlRuntime = '/jndi/weblogic.management.mbeanservers.runtime'
def urlBase = 'service:jmx:t3://localhost:7001'

def serviceURL = new JMXServiceURL(urlBase + urlRuntime)
def h = new Hashtable()
h.put(Context.SECURITY_PRINCIPAL, 'weblogic')
h.put(Context.SECURITY_CREDENTIALS, 'weblogic')
h.put(JMXConnectorFactory.PROTOCOL_PROVIDER_PACKAGES, 'weblogic.management.remote')
def server = JMXConnectorFactory.connect(serviceURL, h).mBeanServerConnection
def domainName = new ObjectName('com.bea:Name=RuntimeService,' +
'Type=weblogic.management.mbeanservers.runtime.RuntimeServiceMBean')
def rtName = server.getAttribute(domainName, 'ServerRuntime')
def rt = new GroovyMBean(server, rtName)
println "Server: name=$rt.Name, state=$rt.State, version=$rt.WeblogicVersion"
def destFilter = Query.match(Query.attr('Type'), Query.value('JMSDestinationRuntime'))
server.queryNames(new ObjectName('com.bea:*'), destFilter).each{ name ->
def jms = new GroovyMBean(server, name)
println "JMS Destination: name=$jms.Name, type=$jms.DestinationType"+
", messages=$jms.MessagesReceivedCount"
}
```

Here is the output:

```
Server: name=examplesServer, state=RUNNING, version=WebLogic Server 10.0 Wed May 9 18:10:27 EDT
2007 933139
JMS Destination: name=examples-jms!exampleTopic, type=Topic, messages=0
JMS Destination: name=examples-jms!exampleQueue, type=Queue, messages=0
JMS Destination: name=examples-jms!jms/MULTIDATASOURCE_MDB_QUEUE, type=Queue, messages=0
JMS Destination: name=examplesJMSServer!examplesJMSServer.TemporaryQueue0, type=Queue, messages=68
JMS Destination: name=examples-jms!quotes, type=Topic, messages=0
JMS Destination: name=examples-jms!weblogic.wsee.wseeExamplesDestinationQueue, type=Queue,
messages=0
JMS Destination: name=examples-jms!weblogic.examples.ejb30.ExampleQueue, type=Queue, messages=0
```

Spring Example

You can also use Spring to automatically register beans as JMX aware.

Here is an example class (Calculator.groovy):

```
import org.springframework.jmx.export.annotation.*

@ManagedResource(objectName="bean:name=calcMBean", description="Calculator MBean")
public class Calculator {

private int invocations

@ManagedAttribute(description="The Invocation Attribute")
public int getInvocations() {
return invocations
}

private int base = 10

@ManagedAttribute(description="The Base to use when adding strings")
public int getBase() {
```



```

return base
}

@ManagedAttribute(description="The Base to use when adding strings")
public void setBase(int base) {
this.base = base
}

@ManagedOperation(description="Add two numbers")
@ManagedOperationParameters([
@ManagedOperationParameter(name="x", description="The first number"),
@ManagedOperationParameter(name="y", description="The second number")])
public int add(int x, int y) {
invocations++
return x + y
}

@ManagedOperation(description="Add two strings representing numbers of a particular base")
@ManagedOperationParameters([
@ManagedOperationParameter(name="x", description="The first number"),
@ManagedOperationParameter(name="y", description="The second number")])
public String addStrings(String x, String y) {
invocations++
def result = Integer.valueOf(x, base) + Integer.valueOf(y, base)
return Integer.toString(result, base)
}
}

```

Here is the Spring configuration file (beans.xml):

```

<?xml version="1.0" encoding="UTF-8"?>
<beans xmlns="http://www.springframework.org/schema/beans"
xmlns:xsi="http://www.w3.org/2001/XMLSchema-instance"
xsi:schemaLocation="
http://www.springframework.org/schema/beans http://www.springframework.org/schema/beans/spring-
beans.xsd">
<bean id="mbeanServer"
class="org.springframework.jmx.support.MBeanServerFactoryBean">
<property name="locateExistingServerIfPossible" value="true"/>
</bean>

<bean id="exporter"
class="org.springframework.jmx.export.MBeanExporter">
<property name="assembler" ref="assembler"/>
<property name="namingStrategy" ref="namingStrategy"/>
<property name="beans">
<map>
<entry key="bean:name=defaultCalcName" value-ref="calcBean"/>
</map>
</property>
<property name="server" ref="mbeanServer"/>
<property name="autodetect" value="true"/>
</bean>

<bean id="jmxAttributeSource"
class="org.springframework.jmx.export.annotation.AnnotationJmxAttributeSource"/>

<!-- will create management interface using annotation metadata -->
<bean id="assembler"
class="org.springframework.jmx.export.assembler.MetadataMBeanInfoAssembler">
<property name="attributeSource" ref="jmxAttributeSource"/>
</bean>

<!-- will pick up the ObjectName from the annotation -->
<bean id="namingStrategy"
class="org.springframework.jmx.export.naming.MetadataNamingStrategy">

```

```

<property name="attributeSource" ref="jmxAttributeSource"/>
</bean>

<bean id="calcBean"
class="Calculator">
<property name="base" value="10"/>
</bean>
</beans>

```

Here is a script which uses this bean and configuration:

```

import org.springframework.context.support.ClassPathXmlApplicationContext
import java.lang.management.ManagementFactory
import javax.management.ObjectName
import javax.management.Attribute

// get normal bean
def ctx = new ClassPathXmlApplicationContext("beans.xml")
def calc = ctx.getBean("calcBean")

Thread.start{
// access bean via JMX, use a separate thread just to
// show that we could access remotely if we wanted
def server = ManagementFactory.platformMBeanServer
def mbean = new GroovyMBean(server, 'bean:name=calcMBean')
sleep 1000
assert 8 == mbean.add(7, 1)
mbean.Base = 8
assert '10' == mbean.addStrings('7', '1')
mbean.Base = 16
sleep 2000
println "Number of invocations: ${mbean.Invocations}"
println mbean
}

assert 15 == calc.add(9, 6)
assert '11' == calc.addStrings('10', '1')
sleep 2000
assert '20' == calc.addStrings('1f', '1')

```

And here is the resulting output:

```

Number of invocations: 5
MBean Name:
bean:name=calcMBean

Attributes:
(rw) int Base
(r) int Invocations
Operations:
int add(int x, int y)
java.lang.String addStrings(java.lang.String x, java.lang.String y)
int getInvocations()
int getBase()
void setBase(int p1)

```

You can even attach to the process while it is running with [jconsole](#). It will look something like: [!jconsole.gif](#)! We started the Groovy application with the `-Dcom.sun.management.jmxremote` JVM argument using a Java 5 JVM.

See also:

- [Dynamic language beans in Spring](#)
- [Using Spring Factories with Groovy](#)
- [Spring JMX Documentation](#)

Troubleshooting

groovy.lang.MissingMethodException or groovy.lang.GroovyRuntimeException

If you get an error like this

```
groovy.lang.MissingMethodException: No signature of method:
javax.management.remote.rmi.RMIConnector$RemoteMBeanServerConnection.queryMBeans()
is applicable for argument types: (javax.management.ObjectName, null)
values: {Catalina:*, null}
```

or like this:

```
Caught: groovy.lang.GroovyRuntimeException: Could not find matching constructor for:
groovy.util.GroovyMBean(javax.management.remote.rmi.RMIConnector$RemoteMBeanServerConnection,
java.lang.String)
```

you have to move away or delete "mx4j-*.jar" from "\$GROOVY_HOME/lib". MX4J is designed to add javax.management classes to 1.4 JVMs. If you already have a newer JMX jar on your classpath or are using a Java 5 or higher JVM, the MX4J classes will be incompatible with the ones from the newer Sun JVMs or newer versions of JMX.

java.lang.SecurityException

If you get the following error, your container's JMX access is password protected:

```
java.lang.SecurityException: Authentication failed! Credentials required
```

To fix that, add an environment with the credentials when connecting, like this (password has to be set before that):

```
def jmxEnv = null
if (password != null)
jmxEnv = [(JMXConnector.CREDENTIALS): (String[])"monitor", password]]
def connector = JMXConnectorFactory.connect(new JMXServiceURL(serverUrl), jmxEnv)
```

Details for the software you are trying to monitor/manage may differ slightly. Check out the other examples using credentials above if appropriate (e.g. OC4J and WebLogic). If you still have troubles, you will have to consult the documentation for the software you are trying to monitor/manage for details on how to provide credentials.

Further JMX Information

- [Monitoring the Java Virtual Machine](#)
- [Using Groovy for System Management](#)
- [JMX Scripts using JRuby - Part I](#)
- [JMX Scripts using JRuby - Part II](#)
- [Groovier jconsole!](#)
- [JMX Scripts with Eclipse Monkey](#)
- [Using JMX to monitor Apache ActiveMQ](#)
- [Jagger project \(JMX application monitoring with Groovy\)](#)

Groovy Categories

This page last changed on Nov 07, 2007 by antony.stubbs@gmail.com.

There are many situations where you might find that it would be useful if a class not under your control had additional methods that you define. In order to enable this capability, Groovy implements a feature borrowed from [Objective-C](#), called Categories. There are a few categories that are included in the system for adding functionality to classes that make them more usable within the Groovy environment.

- [DOMCategory](#)
- [ServletCategory](#)

The first category allows you to treat DOM objects as arrays and maps so that you can use them in conjunction with the Groovy path expression language and treat them like JavaBeans. Here is an example from the tests of using the DOMCategory:

DOMTest.groovy

```
import groovy.xml.*

def html = DOMBuilder.newInstance().html {
  head {
    title (class:'mytitle', 'Test')
  }
  body {
    p (class:'mystyle', 'This is a test.')
  }
}

use (groovy.xml.dom.DOMCategory) {
  assert html.head.title.text() == 'Test'
  assert html.body.p.text() == 'This is a test.'
  assert html.find{ it.tagName == 'body' }.tagName == 'body'
  assert html.getElementsByTagName('*').grep{ it.'@class' }.size() == 2
}

try {
  html.head
} catch (MissingPropertyException mpe) {
  println "Categories wear off"
}
```

As you can see here we are treating DOM objects just as if they were JavaBeans and are accessing them with GPath. The ServletCategory is similarly used when we want to treat the attributes of Servlet API objects as if they were properties since they don't follow the typical conventions for JavaBeans or Maps either. In the GroovyServlet that lets you use scripts as servlets we call GroovyCategorySupport from Java in order to make it possible to use property accessors against the request:

GroovyServlet.java

```
Closure closure = new Closure(gse) {
  public Object call() {
    try {
      return ((GroovyScriptEngine) getDelegate()).run(scriptUri, binding);
    } catch (ResourceException e) {
      throw new RuntimeException(e);
    } catch (ScriptException e) {
      throw new RuntimeException(e);
    }
  }
};
GroovyCategorySupport.use(ServletCategory.class, closure);
```

This allows users to access things like Session attributes and request Attributes by name instead of through the API within their Groovy servlet scripts. For example, without this you would have to do:

```
if (session.getAttribute("count") == null) then session.setAttribute("count", 1);
```

With this you can say it more tersely as:

```
if (session.count == null) session.count = 1;
```

In order to create your own Categories and extend classes yourself you'll need to understand what the "use" keyword expects to be defined within the class you pass to it. To add a method to a class T, simply define a new class with a static method whose first parameter is of type T. Here is a simple example from the tests:

CategoryTest.groovy

```
class StringCategory {
    static String lower(String string) {
        return string.toLowerCase()
    }
}

use (StringCategory) {
    assert "test" == "TeSt".lower()
}
```

This code will print out the string "test". This facility is extremely powerful and essentially lets you change the way any class in the system works when it is called from Groovy code. Note though that you can't add methods to classes, pass them to Java code, and expect the Java code to be able to call them. Since most people use statically typed Java with little reflection I doubt this case would come up much anyway.

Here is an example of using this as an end user in order to add methods to Apple's own NSDictionary and NSArray class in order to manipulate their Cocoa objects as if they were native Groovy objects:

bookmarks.groovy

```
#!/Users/sam/bin/groovy
// Put /System/Library/Java in your CLASSPATH
import groovy.xml.*;
import groovy.xml.dom.*;
import java.io.*;
import com.apple.cocoa.foundation.*;

class PropertyListCategory {
    static Object get(NSDictionary dictionary, String key) {
        return dictionary.objectForKey(key);
    }
    static Object getAt(NSArray array, int i) {
        return array.objectAtIndex(i);
    }
    static void each(NSArray array, Closure closure) {
        for (i in 0..array.count()-1) {
            closure.call(array[i]);
        }
    }
}

filename = "${System.getProperty("user.home")}/Library/Safari/Bookmarks.plist";
data = new NSData(new File(filename));
errorString = new String[1];
format = new int[1];
plist = NSPropertyListSerialization.propertyListFromData(data,
NSPropertyListSerialization.PropertyListImmutable, format, errorString);

if (errorString[0]) {
    println "Error: ${errorString[0]}";
    System.exit(1);
}

def getURLs(NSArray array, list) {
    array.each {
        getURLs(it, list);
    }
}
```

```

}
}

def getURLs(NSDictionary dict, list) {
if (dict.Children != null) getURLs(dict.Children, list);
if (dict.URIDictionary != null) {
list.add([title:dict.URIDictionary.title, url:dict.URLString]);
}
}

def getURLs(NSDictionary dict) {
use (PropertyListCategory) {
def list = [];
getURLs(dict, list);
}
return list;
}

println getURLs(plist);

```

Notice how we can even create Category classes in Groovy code. They essentially look just like built-in ones within `DefaultGroovyMethods`. Define them by creating a static method that takes the type you want to extend, then the additional parameters that the new method will take.

Groovy CLI

This page last changed on Sep 27, 2006 by [jbaumann](#).

Using Groovy from the command line

The Groovy command line (groovy or groovy.bat) is the easiest way to start using the Groovy Language.

```
$groovy -help
usage: groovy
-a,--autosplit <splitPattern>  automatically split current line
(defaults to '\s')
-c,--encoding <charset>       specify the encoding of the files
-e <script>                    specify a command line script
-h,--help                      usage information
-i <extension>                modify files in place
-l <port>                       listen on a port and process inbound lines
-n                             process files line by line
-p                             process files line by line and print result
-v,--version                   display the Groovy and JVM versions
```

If you have a groovy script, you can edit and run the script immediately.

```
$ cat test.groovy
println 'Hello Bonson'

$ groovy test.groovy
Hello Bonson
```

Here is an example with your own command line arguments.

```
$ cat test.groovy
println 'Hello ' + args[0]

$ groovy test.groovy Jeeves
Hello Jeeves
```

However you can also run such a simple groovy program by providing the script in the command line arguments.

```
$ groovy -e "println 'Hello Bob'"
Hello Bob
```

This may not look useful, but it fits in with the UNIX tradition of chaining simple programs together to build powerful commands. Tools like perl, sed, awk and grep do these jobs very well. But many users have limited experience with these tools' arcane syntax and will be more familiar with Java and therefore Groovy.

```
$ grep -i ^groov /usr/share/dict/words | groovy -e 'print System.in.text.toUpperCase()'
GROOVE
GROOVELESS
GROOVELIKE
GROOVER
GROOVERHEAD
GROOVINESS
GROOVING
GROOVY
```

Because looping through STDIN or input files tends to be a common thing to do, groovy (and ruby, perl etc) provide shortcuts for this. **currently broken, groovy not flushing output (still so 060927?)**

-n will loop through each line of the input, and provide it to your script in the *line* variable.

```
grep -i ^groov /usr/share/dict/words | groovy -n -e 'println line.toUpperCase()'
```

If we definitely want to print the output of each line we can use -p and shorten it to

```
grep -i ^groov /usr/share/dict/words | groovy -p -e 'line.toUpperCase()'
```

We can use the looping constructs along with `-i`, which writes the output back to the original files (and creates a backup copy with the given extension). And wreak havoc on our local file system, with wide-scale search and replace.

```
groovy -p -i .bak -e '(line =~ "<h\\d>(.*?)</h\\d>").replaceAll("$1")' ~/Desktop/cooluri.html
```

TIP: Never ever use the option `-i` without a backup extension.

Or to really get into groovy (literally)

```
find . -name \*.java | xargs groovy -p -i -e '(line =~ "@author James Strachan").replaceAll("@author Bobby Bonson")'
```

Additionally you have access to the line number in the current file you are reading via the variable `count`. This can be used for a number of convenient groovy one-liners.

Let us assume you want to prefix every line in a file with the line number. Doing this requires next to no work in Groovy (we additionally create a copy of the original file with the extension `.bak`).

```
groovy -pi .bak -e "count + ': ' + line"
```

Or let us create a grep-like command that prints the line number where it found matching strings for a regular expression.

```
groovy -p -e "if(line =~ /groovy/)count + ': ' + line"
```

Print the first 50 lines of all files:

```
groovy -p -e "if(count < 50) line"
```

until one file is longer than 50 lines:

```
groovy -p -e "if(count >= 50)System.exit(0);line"
```

Add a Groovy-Shebang (the string `#!/usr/bin/groovy`) to all Groovy files:

```
groovy -i .bak -pe "if(count == 1) println '#!/usr/bin/groovy'" *.groovy
```

Another very convenient option is `-a`, which splits the current input line into the array `split`. By default the split pattern is " " (one space). The option `-a` optionally takes another split pattern which is then used instead.

Print processes owned by root:

```
ps aux|groovy -ane "if(split[0] =~ 'root')println split[10..-1]"
```

Print all logins from `/etc/passwd` that are not commented:

```
groovy -a':' -ne "if(!(split[0] =~ /^#/))println split[0]" /etc/passwd
```

Add the first and the penultimate column of a file:

```
groovy -ape "split[0].toInteger()+split[-2].toInteger()" accounts.txt
```

For more examples or inspiration browse through the search results for [Perl One Liners](#)

listen mode

Another groovy command line option is the ability to startup groovy in listen mode, which will attach groovy to a TCP port on your machine (`-l <port>` with a default port of 1960).

For each connection that is made to this port, groovy executes the supplied script on a line by line basis.

This oneliner will reverse every line that is thrown at it, try telnet to your machine on port 1960 to interact with this script.

```
groovy -l -e "println line.reverse()"
```

you can combine the `-p` option from earlier, to automatically print the result of your script

The following one liner is equivalent to the one liner immediately above.

```
groovy -l -p -e "line.reverse()"
```

More examples of useful command line scripts in [SVN](#)

Groovy Console

This page last changed on Oct 31, 2007 by paulk_asert.

The Groovy Swing Console allows a user to enter and run Groovy scripts. This page documents the features of this user interface.

Basics

The Groovy Console:

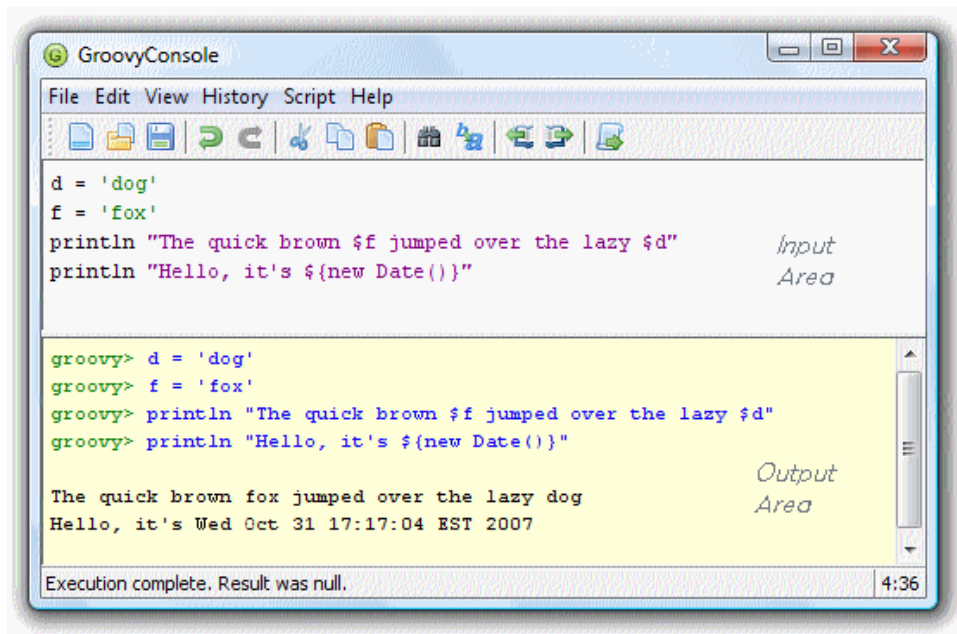

1. The Console has an input area and an output area.
2. You type a Groovy script in the input area.
3. When you select "Run" from the "Actions" menu, the console compiles the script and runs it.
4. Anything that would normally be printed on System.out is printed in the output area.
5. If the script returns a non-null result, that result is printed.

Features

Running Scripts

Handy tips for running scripts:

- Ctrl+Enter and Ctrl+R are both shortcut keys for "Run Script".
- If you highlight just part of the text in the input area, then Groovy runs just that text.
- The result of a script is the value of the last expression executed.
- You can turn the System.out capture on and off by selecting "Capture System.out" from the "Actions" menu

Editing Files

You can open any text file, edit it, run it (as a Groovy Script) and then save it again when you are finished.

- Select File -> Open (shortcut key ctrl+O) to open a file
- Select File -> Save (shortcut key ctrl+S) to save a file
- Select File -> New File (shortcut key ctrl+Q) to start again with a blank

input area

History and results

- You can pop-up a gui inspector on the last (non-null) result by selecting "Inspect Last" from the "Actions" menu. The inspector is a convenient way to view lists and maps.
- The console remembers the last ten script runs. You can scroll back and forth through the history by selecting "Next" and "Previous" from the "Edit" menu. Ctrl-N and ctrl-P are convenient shortcut keys.
- The last (non-null) result is bound to a variable named '_' (an underscore).
- The last result (null and non-null) for every run in the history is bound into a list variable named '___' (two underscores). The result of the last run is ___[-1], the result of the second to last run is ___[-2] and so forth.

And more

- You can attempt to interrupt a long running task by clicking the "interrupt" button on the small dialog box that pops up when a script is executing.
- You can change the font size by selecting "Smaller Font" or "Larger Font" from the "Actions menu"

Embedding the Console

To embed a Swing console in your application, simply create the Console object, load some variables, and then launch it. The console can be embedded in either Java or Groovy code. The Java code for this is:

```
import groovy.ui.Console;
```

```
...
```

```
Console console = new Console();  
console.setVariable("var1", getValueOfVar1());  
console.setVariable("var2", getValueOfVar2());  
console.run();
```

```
...
```

Once the console is launched, you can use the variable values in Groovy code.

An example of how to embed either the GroovyConsole or GroovyShell in a Spring Web application can be found at [Embedding a Groovy Console in a Java Server Application](#)

Groovy Math

This page last changed on Aug 30, 2007 by [gavingrover](#).

Groovy supports access to all Java math classes and operations. However, in order to make scripting math operations as intuitive as possible to the end user, the groovy math model supports a 'least surprising' approach to literal math operations for script programmers. To do this, groovy uses exact, or decimal math for default calculations.

This means that user computations like:

```
1.1 + 0.1 == 1.2
```

will return true rather than false (using float or double types in Java returns a result of 1.2000000000000002).

Numeric literals

To support the 'least surprising' approach, groovy literals with decimal points are instantiated as *java.math.BigDecimal* types rather than binary floating point types (Float, Double). Float and Double types can of course be created explicitly or via the use of a suffix (see table below). Exponential notation is supported for decimal types (BigDecimal, Double Float) with or without a signed exponent (1.23E-23). Hexadecimal and octal literals are also supported. Hexadecimal numbers are specified

in the typical format of "0x" followed by hex digits (e.g. 0x77).

Integral numeric literals (those without a decimal point) which begin with a 0 are treated as octal. Both octal and hexadecimal literals may have an integral suffix (G,L,I). Integral numeric literals without a suffix will be the smallest type into which the value will fit (Integer, Long, or BigInteger). See the numeric literal grammar at the end of this page for more details on syntax.

Type	Suffix
BigInteger	G
Long	L
Integer	I
BigDecimal	G
Double	D
Float	F

Examples:

```
assert 42I == new Integer("42");
assert 123L == new Long("123");
assert 2147483648 == new Long("2147483648"); //Long type used, value too large for an Integer
assert 456G == new java.math.BigInteger("456");
assert 123.45 == new java.math.BigDecimal("123.45"); //default BigDecimal type used
assert 1.200065D == new Double("1.200065");
assert 1.234F == new Float("1.234");
assert 1.23E23D == new Double("1.23E23");
```

Math operations

While the default behavior is to use decimal math, no attempt is made to preserve this if a binary floating point number is introduced into an expression (i.e. groovy never automatically promotes a binary floating point number to a BigDecimal). This is done for two reasons: First, doing so would imply a level of exactness to a result that is not guaranteed to be exact, and secondly, performance is slightly better under binary floating point math, so once it is introduced it is kept.

Finally, Groovy's math implementation is as close as practical to the Java 1.5 BigDecimal math model which implements precision based floating point decimal math (ANSI X3.274-1996 and ANSI X3.274-1996/AM 1-2000 (section 7.4)).

Therefore, binary operations involving subclasses of java.lang.Number automatically convert their arguments according to the following matrix (except for division, which is discussed below).

	BigDecimal	BigInteger	Double	Float	Long	Integer
BigDecimal	BigDecimal	BigDecimal	Double	Double	BigDecimal	BigDecimal
BigInteger	BigDecimal	BigInteger	Double	Double	BigInteger	BigInteger
Double	Double	Double	Double	Double	Double	Double
Float	Double	Double	Double	Double	Double	Double
Long	BigDecimal	BigInteger	Double	Double	Long	Long
Integer	BigDecimal	BigInteger	Double	Double	Long	Integer

Note - Byte, Character, and Short arguments are considered to be Integer types for the purposes of this matrix.

Division

The division operators "/" and "/"= produce a Double result if either operand is either Float or Double and a BigDecimal result otherwise (both operands are any combination of Integer, Long, BigInteger, or BigDecimal). BigDecimal Division is performed as follows:

```
BigDecimal.divide(BigDecimal right, <scale>, BigDecimal.ROUND_HALF_UP)
```

where <scale> is MAX(this.scale(), right.scale(), 10). Finally, the resulting BigDecimal is normalized (trailing zeros are removed).

For example:

```
1/2 == new java.math.BigDecimal("0.5");
1/3 == new java.math.BigDecimal("0.3333333333");
2/3 == new java.math.BigDecimal("0.6666666667");
```

Integer division can be performed on the integral types by casting the result of the division. For example:

```
assert (int)(3/2) == 1;
```

Future versions of Groovy may support an integer division operator such as div and/or ÷.

Power Operator

Since groovy 1.0 beta 10 release, the power operator "**" is supported for math calculation. For example, 5**3 equals to Math.pow(5,3).

Java code:

```
// y = 2 x^3 + 5 x^2 - 3 x + 2
def x = 5.0;
def y = 2.0 * Math.pow(x,3) + 5.0 * Math.pow(x,2) - 3.0*x + 2.0
```

Groovy code:

```
// y = 2 x^3 + 5 x^2 - 3 x + 2
def x = 5.0;
def y = 2.0*x**3 + 5.0*x**2 - 3.0*x + 2.0
```

More In-depth Information

Groovy and Java Math is explained in more depth in these pages:

[Integer Math](#)

[Decimal Math](#)

[Floating Point Math](#)

Numeric literal grammar

```
IntegerLiteral:  
Base10IntegerLiteral  
HexIntegerLiteral  
OctalIntegerLiteral
```

```
Base10IntegerLiteral:  
Base10Numeral IntegerTypeSuffix (optional)
```

```
HexIntegerLiteral:  
HexNumeral IntegerTypeSuffix (optional)
```

```
OctalIntegerLiteral:  
OctalNumeral IntegerTypeSuffix (optional)
```

```
IntegerTypeSuffix: one of  
i I l L g G
```

```
Base10Numeral:  
0  
NonZeroDigit Digits (optional)
```

```
Digits:  
Digit  
Digits Digit
```

```
Digit:  
0  
NonZeroDigit
```

```
NonZeroDigit: one of  
\1 2 3 4 5 6 7 8 9
```

```
HexNumeral:  
0 x HexDigits  
0 X HexDigits
```

```
HexDigits:  
HexDigit  
HexDigit HexDigits
```

```
HexDigit: one of  
0 1 2 3 4 5 6 7 8 9 a b c d e f A B C D E F
```

```
OctalNumeral:  
0 OctalDigits
```

```
OctalDigits:  
OctalDigit  
OctalDigit OctalDigits
```

```
OctalDigit: one of  
0 1 2 3 4 5 6 7
```

DecimalPointLiteral:
Digits . Digits ExponentPart (optional) DecimalTypeSuffix (optional)
. Digits ExponentPart (optional) DecimalTypeSuffix (optional)
Digits ExponentPart DecimalTypeSuffix (optional)
Digits ExponentPart (optional) DecimalTypeSuffix (optional)

ExponentPart:
ExponentIndicator SignedInteger

ExponentIndicator: one of
e E

SignedInteger:
Signopt Digits

Sign: one of
+ -

DecimalTypeSuffix: one of
f F d D g G

Groovy Maven Plugin

This page last changed on Apr 07, 2008 by [user57](#).

MOVED

This content has been moved to [GMaven](#). Please update your links, this page will go away in the near future.

Groovy Maven Plugin

Description

Allows Groovy scripts to be used from within the [Maven 2](#) environment and Maven 2 plugins to be implemented in Groovy!

Current release: 1.0-beta-3

What is New

With this release comes a completely rewritten core, which allows the Groovy runtime version to be changed. Also a brand new stub-generator that preserves Javadocs (so the standard `maven-javadoc-plugin` works with it). And a `org.codehaus.mojo:groovy-maven-plugin` has been crafted to provide a link to the `org.codehaus.mojo.groovy:groovy-maven-plugin`, which means that `mvn groovy:shell` works!

For more details see the [changelog](#).

 Please make sure you are using the `org.codehaus.mojo.groovy` groupId in your projects and that you are looking at the [latest site docs](#) for the current documentation.

Execute a Groovy Script

```
<plugin>
<groupId> org.codehaus.mojo.groovy</groupId>
<artifactId>groovy-maven-plugin</artifactId>
<executions>
<execution>
<phase>generate-resources</phase>
<goals>
<goal>execute</goal>
</goals>
<configuration>
<source>
if (project.packaging != "pom") {
log.info("Copying some stuff...")
def dir = "${project.basedir}/target/classes/META-INF"

ant.mkdir(dir: dir)
ant.copy(todir: dir) {
fileset(dir: "${project.basedir}") {
include(name: "LICENSE.txt")
include(name: "NOTICE.txt")
}
}
}
</source>
</configuration>
</execution>
</executions>
</plugin>
```

For more details see the [executing examples](#).

Compile Groovy Sources

```
<plugin>
<groupId> org.codehaus.mojo.groovy</groupId>
<artifactId>groovy-maven-plugin</artifactId>
<executions>
<execution>
<goals>
<goal>compile</goal>
</goals>
</execution>
</executions>
</plugin>
```

And test sources too:

```
<plugin>
<groupId>org.codehaus.mojo.groovy</groupId>
<artifactId>groovy-maven-plugin</artifactId>
<executions>
<execution>
<goals>
<goal>testCompile</goal>
</goals>
</execution>
</executions>
</plugin>
```

For more details more see the [compiling examples](#).

References

- [Groovy Maven Support](#) - Home page

Groovy Shell

This page last changed on Apr 08, 2008 by [paulk_asert](#).

Groovy Shell

The Groovy Shell, aka. `groovysh` is a command-line application which allows easy access to evaluate Groovy expressions, define classes and run simple experiments.

- [Features](#)
- [Command-line Options and Arguments](#)
- [Evaluating Expressions](#)
 - [Simple Expressions](#)
 - [Evaluation Result](#)
 - [Multi-line Expressions](#)
 - [Variables](#)
 - [Functions](#)
- [Commands](#)
 - [Recognized Commands](#)
- [Preferences](#)
 - [Recognized Preferences](#)
 - [Listing Preferences](#)
 - [Clearing Preferences \(ie. Resetting to Defaults\)](#)
- [User Profile Scripts and State](#)
 - [Profile Scripts](#)
 - [State](#)
- [Screen Shots](#)
- [Troubleshooting](#)
 - [Platform Problems](#)

Features

- No need for `go` command to execute buffer.
- Rich cross-platform edit-line editing, history and completion thanks to [JLine](#).
- ANSI colors (prompt, exception traces, etc).
- Simple, yet robust, command system with online help, user alias support and more.
- User profile support

Command-line Options and Arguments

The shell supports several options to control verbosity, ANSI coloring and other features.

```
./bin/groovysh --help
usage: groovysh [options] [...]
-C, --color[=FLAG]      Enable or disable use of ANSI colors
-D, --define=NAME=VALUE Define a system property
-T, --terminal=TYPE     Specify the terminal TYPE to use
-V, --version           Display the version
-d, --debug             Enable debug output
-h, --help              Display this help message
-q, --quiet             Suppress superfluous output
-v, --verbose           Enable verbose output
```

In addition to options, commands or expressions can be given on the command-line which will invoke the shell in non-interactive mode. The commands or expressions will be evaluated and the shell will exit. If no additional arguments are given the shell will startup interactively.

Execute a Command

```
./bin/groovysh 'show preferences'
No preferences are set
```

Evaluate an Expression

```
./bin/groovysh 'System.properties.each { k, v -> println("$k = $v") }'  
java.runtime.name = Java(TM) 2 Runtime Environment, Standard Edition  
sun.boot.library.path = /System/Library/Frameworks/JavaVM.framework/Versions/1.5.0/Libraries  
java.vm.version = 1.5.0_07-87  
awt.nativeDoubleBuffering = true  
gopherProxySet = false  
...
```

Evaluating Expressions

Simple Expressions

```
println "Hello"
```

Evaluation Result

When a complete expression is found, it is compiled and evaluated. The result of the evaluation is stored into the `_` variable.

Multi-line Expressions

Multi-line/complex expressions (like closure or class definitions) may be defined over several lines. When the shell detects that it has a complete expression it will compile and evaluate it.

Define a Class

```
class Foo {  
  def bar() {  
    println "baz"  
  }  
}
```

Use the Class

```
foo = new Foo()  
foo.bar()
```

Variables

Shell variables are **all** untyped (ie. no `def` or other type information).

This **will** set a shell variable:

```
foo = "bar"
```

But, this will evaluate a local variable and will **not** be saved to the shell's environment:

```
def foo = "bar"
```

Functions

Functions can be defined in the shell, and will be saved for later use.

Defining a function is easy:

```
groovy:000> def hello(name) {  
groovy:001> println("Hello $name")  
groovy:002> }
```

And then using it is as one might expect:

```
hello("Jason")
```



Internally the shell creates a closure to encapsulate the function and then binds the closure to a variable. So variables and functions share the same namespace.

Commands

The shell has a number of different commands, which provide rich access to the shell's environment.

Commands all have a *name* and a *shortcut* (which is something like `\h`). Commands may also have some predefined system *aliases*. Users may also create their own aliases.

Recognized Commands

help

Display the list of commands (and aliases) or the help text for specific command.

The Command List

```
groovy:000> help
```

```
For information about Groovy, visit:  
http://groovy.codehaus.org
```

```
Available commands:
```

```
help      (\h ) Display this help message  
?         (? ) Alias to: help  
exit      (\x ) Exit the shell  
quit      (\q ) Alias to: exit  
import    (\i ) Import a class into the namespace  
display   (\d ) Display the current buffer  
clear     (\c ) Clear the buffer  
show      (\S ) Show variables, classes or imports  
inspect   (\n ) Inspect a variable or the last result with the GUI object browser  
purge     (\p ) Purge variables, classes, imports or buffers  
edit      (\e ) Edit the current buffer  
load      (\l ) Load a file or URL into the buffer  
.         (\. ) Alias to: load  
save      (\s ) Save the current buffer to a file  
record    (\r ) Record the current session to a file  
history   (\H ) Display, manage and recall edit-line history  
alias     (\a ) Create an alias  
set       (\= ) Set (or list) preferences
```

```
For help on a specific command type:  
help <command>
```

Help for a Command

While in the interactive shell, you can ask for help for any command to get more details about its syntax or function. Here is an example of what happens when you ask for help for the `help` command:

```
groovy:000> help help
```

```
usage: help [<command>]
```

```
Display the list of commands or the help text for <command>.
```

exit

Exit the shell.

This is the **only** way to exit the shell. Well, you can still CTRL-C, but the shell will complain about an abnormal shutdown of the JVM.

import

Add a custom import which will be included for all shell evaluations.

This command can be given at any time to add new imports.

display

Display the contents of the current buffer.

This only displays the buffer of an incomplete expression. Once the expression is complete, the buffer is reset. The prompt will update to show the size of the current buffer as well.

Example

```
groovy:000> class Foo {
groovy:001> def bar
groovy:002> def baz() {
groovy:003> display
001> class Foo {
002> def bar
003> def baz() {
```

clear

Clear the current buffer.

show

Show variables, classes or preferences or imports.

show variables

```
groovy:000> show variables
Variables:
_ = true
```

show classes

show imports

show preferences

show all

inspect

Opens the GUI object browser to inspect a variable or the result of the last evaluation.

purge

Purges objects from the shell.

`purge variables`

`purge classes`

`purge imports`

`purge preferences`

`purge all`

`edit`

Edit the current buffer in an external editor.

Currently only works on UNIX systems which have the `EDITOR` environment variable set.

`load`

Load one or more files (or urls) into the buffer.

`save`

Saves the buffer's contents to a file.

`record`

Record the current session to a file.

`record start`

`record stop`

`record status`

`history`

Display, manage and recall edit-line history.

`history show`

`history recall`

`history flush`

`history clear`

`alias`

Create an alias.

`set`

Set or list preferences.

Preferences

Some of aspects of `groovysh` behaviors can be customized by setting preferences. Preferences are set using the `set` command or the `\=` shortcut.

Recognized Preferences

`verbosity`

Set the shell's verbosity level. Expected to be one of:

- `DEBUG`
- `VERBOSE`
- `INFO`
- `QUIET`

Default is `INFO`.

If this preference is set to an invalid value, then the previous setting will be used, or if there is none, then the preference is removed and the default is used.

`show-last-result`

Show the last result after an execution.

Default is `true`.

`sanitize-stack-trace`

Sanitize (trim-down/filter) stack traces.

Default is `true`.

Setting a Preference

```
set verbosity DEBUG
```

Listing Preferences

To list the current `set` preferences (and their values):

```
show preferences
```



Limitation

At the moment, there is no way to list all of the known/available preferences to be set.

Clearing Preferences (ie. Resetting to Defaults)

```
purge preferences
```

User Profile Scripts and State

Profile Scripts

```
$HOME/.groovy/groovysh.profile
```

This script, if it exists, is loaded when the shell starts up.

```
$HOME/.groovy/groovysh.rc
```

This script, if it exists, is loaded when the shell enters interactive mode.

State

`$HOME/.groovy/groovysh.history`

Edit-line history is stored in this file.

Screen Shots

These shots have been taken over the development of the new shell, so some of the content might look slightly different. Also, note the yellow colors here are the shell's *bold* color, so the colors might look different depending on how the enclosing shell has its colors setup.

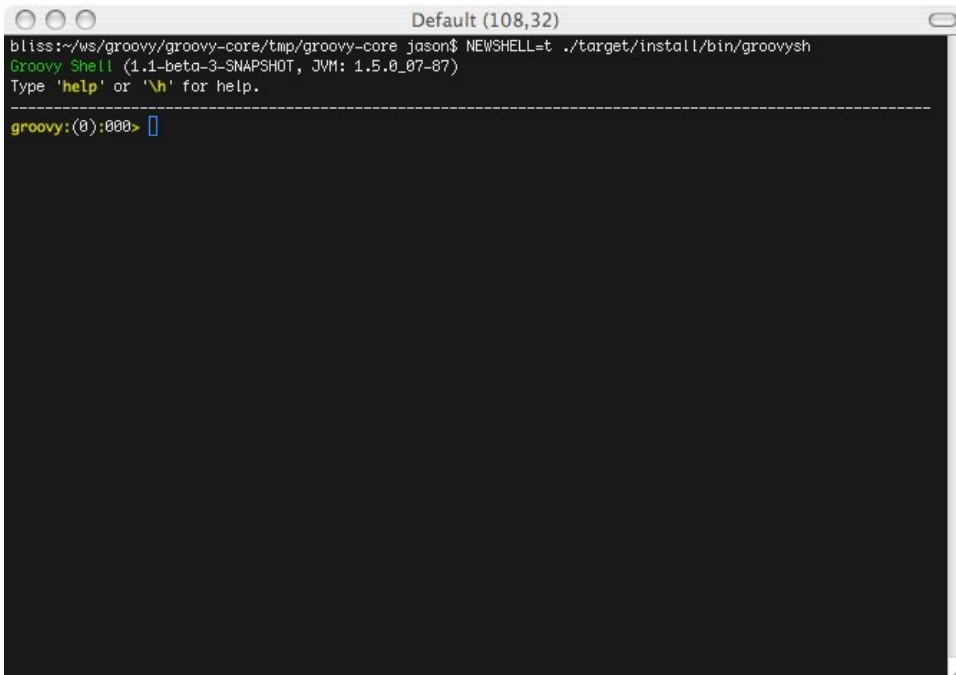

```
bliss:~/ws/groovy/groovy-core/tmp/groovy-core jason$ NEWSHELL=t ./target/install/bin/groovysh
Groovy Shell (1.1-beta-3-SNAPSHOT, JVM: 1.5.0_07-87)
Type 'help' or '\h' for help.

groovy:(0):000> 
```

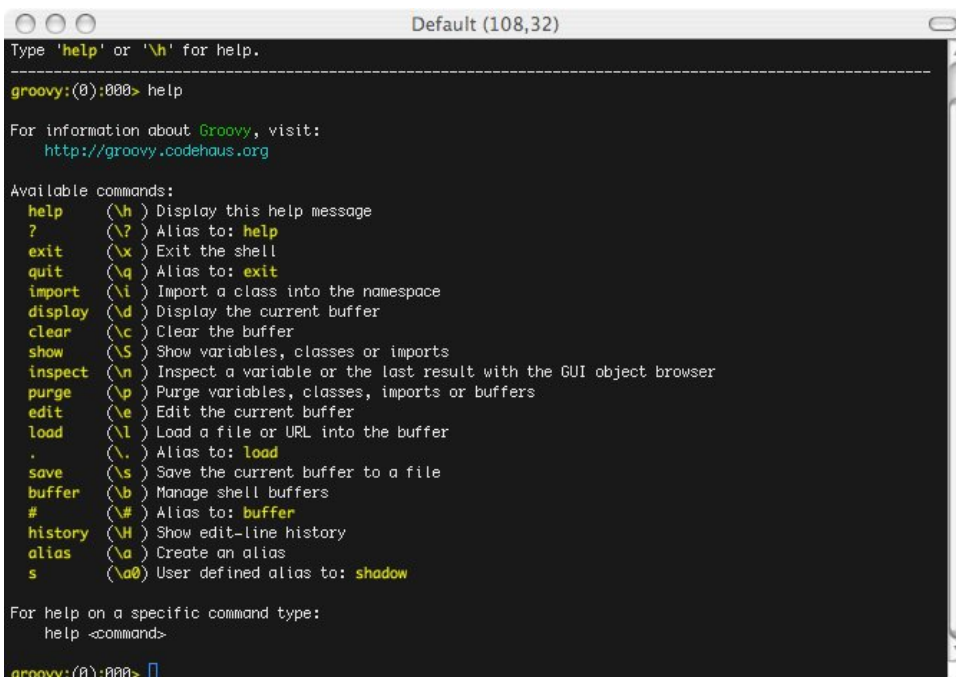

```
Type 'help' or '\h' for help.

groovy:(0):000> help

For information about Groovy, visit:
  http://groovy.codehaus.org

Available commands:
  help    (\h) Display this help message
  ?       (\?) Alias to: help
  exit    (\x) Exit the shell
  quit    (\q) Alias to: exit
  import  (\i) Import a class into the namespace
  display (\d) Display the current buffer
  clear   (\c) Clear the buffer
  show    (\s) Show variables, classes or imports
  inspect (\n) Inspect a variable or the last result with the GUI object browser
  purge   (\p) Purge variables, classes, imports or buffers
  edit    (\e) Edit the current buffer
  load    (\l) Load a file or URL into the buffer
  .       (\.) Alias to: load
  save    (\s) Save the current buffer to a file
  buffer  (\b) Manage shell buffers
  #       (\#) Alias to: buffer
  history (\H) Show edit-line history
  alias   (\a) Create an alias
  s       (\a0) User defined alias to: shadow

For help on a specific command type:
  help <command>

groovy:(0):000> 
```

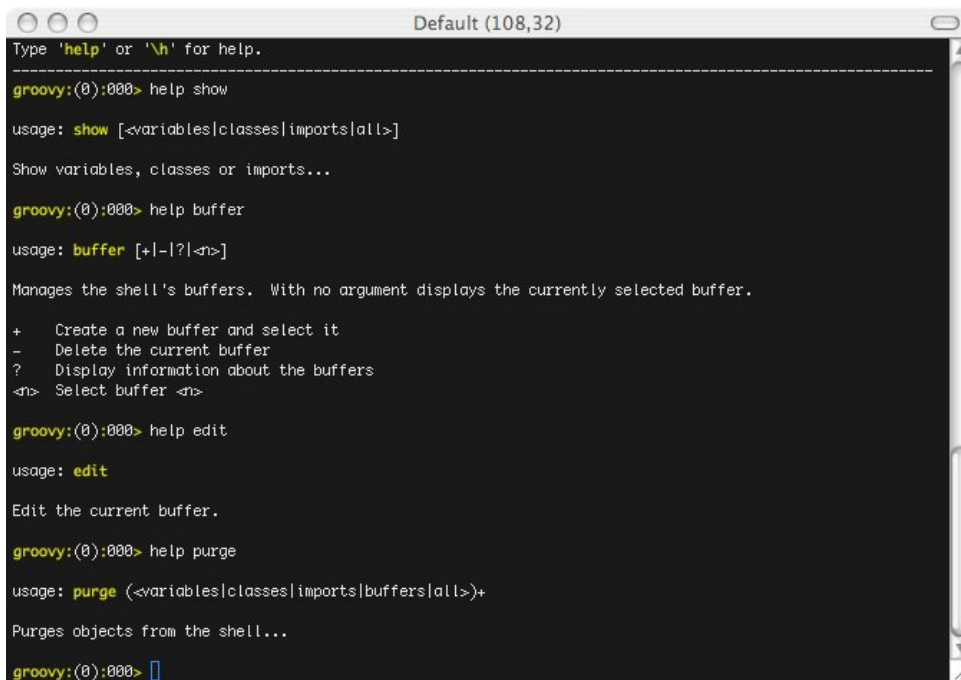
```
Default (108,32)
Type 'help' or '\h' for help.
groovy:(0):000> help show
usage: show [<variables|classes|imports|all>]
Show variables, classes or imports...
groovy:(0):000> help buffer
usage: buffer [+|-|?|<n>]
Manages the shell's buffers. With no argument displays the currently selected buffer.
+ Create a new buffer and select it
- Delete the current buffer
? Display information about the buffers
<n> Select buffer <n>
groovy:(0):000> help edit
usage: edit
Edit the current buffer.
groovy:(0):000> help purge
usage: purge [<variables|classes|imports|buffers|all>]+
Purges objects from the shell...
groovy:(0):000> 
```

Troubleshooting

Please [report](#) any problems you run into. Please be sure to mark the JIRA issue with the Groovysh component.

Platform Problems

Problems loading the JLine DLL

On Windows, [JLine](#) (which is used for the fancy shell input/history/completion fluff), uses a **tiny** DLL file to trick the **evil** Windows faux-shell (CMD.EXE or COMMAND.COM) into providing Java with unbuffered input. In some rare cases, this might fail to load or initialize.

One solution is to disable the frills and use the unsupported terminal instance. You can do that on the command-line using the `--terminal` flag and set it to one of:

- none
- false
- off
- `jline.UnsupportedTerminal`

```
groovysh --terminal=none
```

Problems with Cygwin on Windows

Some people have issues when running groovysh with cygwin. If you have troubles, the following may help:

```
stty -icanon min 1 -echo
groovysh --terminal=unix
stty icanon echo
```

Groovy Truth

This page last changed on Dec 26, 2007 by [paulk_asert](#).

Boolean expressions

Groovy supports the standard conditional operators on boolean expressions, e.g.:

```
def a = true
def b = true
def c = false
assert a
assert a && b
assert a || c
assert !c
```

In addition, Groovy has special rules for coercing non-boolean objects to a boolean value.

Collections

Empty collections are coerced to false.

```
def numbers = [1,2,3]
assert numbers //true, as numbers is not empty
numbers = []
assert !numbers //false, as numbers is now an empty collection
```

Iterators and Enumerations

Iterators and Enumerations with no further elements are coerced to false.

```
assert ![].iterator() // false because the Iterator is empty
assert [0].iterator() // true because the Iterator has a next element
def v = new Vector()
assert !v.elements() // false because the Enumeration is empty
v.add(new Object())
assert v.elements() // true because the Enumeration has more elements
```

Maps

Non-empty maps are coerced to true.

```
assert ['one':1]
assert ![:]
```

Matchers

Matching regex patterns are coerced to true.

```
assert ('Hello World' =~ /World/) //true because matcher has at least one match
```

Strings

Non-empty Strings, GStrings and CharSequences are coerced to true.

```
// Strings
assert 'This is true'
assert !''
//GStrings
def s = ''
assert !("$s")
s = 'x'
assert ("$s")
```

Numbers

Non-zero numbers are coerced to true.

```
assert !0 //yeah, 0s are false, like in Perl
assert 1 //this is also true for all other number types
```

Object references

Non-null object references are coerced to true.

```
assert new Object()
assert !null
```

Groovy Utils

This page last changed on Nov 01, 2007 by [aalmiray](#).

Groovy Utils

This page documents the utility classes available in the `groovy.utils.*` package.

1. [ConfigSlurper](#)
2. [ObjectGraphBuilder](#)
3. [ObservableMap](#)

ConfigSlurper

This page last changed on Mar 06, 2008 by [mlentzner](#).

ConfigSlurper

[ConfigSlurper](#) is a utility class within Groovy for writing properties file like scripts for performing configuration. Unlike regular Java properties files ConfigSlurper scripts support native Java types and are structured like a tree.

Below is an example of how you could configure Log4j with a ConfigSlurper script:

```
log4j.appender.stdout = "org.apache.log4j.ConsoleAppender"
log4j.appender."stdout.layout"="org.apache.log4j.PatternLayout"
log4j.rootLogger="error,stdout"
log4j.logger.org.springframework="info,stdout"
log4j.additivity.org.springframework=false
```

To load this into a readable config you can do:

```
def config = new ConfigSlurper().parse(new File('myconfig.groovy').toURL())

assert "info,stdout" == config.log4j.logger.org.springframework
assert false == config.log4j.additivity.org.springframework
```

As you can see from the example above you can navigate the config using dot notation and the return values are Java types like strings and booleans.

You can also use scoping in config scripts to avoid repeating yourself. So the above config could also be written as:

```
log4j {
  appender.stdout = "org.apache.log4j.ConsoleAppender"
  appender."stdout.layout"="org.apache.log4j.PatternLayout"
  rootLogger="error,stdout"
  logger {
    org.springframework="info,stdout"
  }
  additivity {
    org.springframework=false
  }
}
```

Converting to and from Java properties files

You can convert ConfigSlurper configs to and from Java properties files. For example:

```
java.util.Properties props = // load from somewhere

def config = new ConfigSlurper().parse(props)

props = config.toProperties()
```

Merging configurations

You can merge config objects so if you have multiple config files and want to create one central config object you can do:

```
def config1 = new ConfigSlurper().parse(..)
def config2 = new ConfigSlurper().parse(..)

config1 = config1.merge(config2)
```

Serializing a configuration to disk

You can serialize a config object to disk. Each config object implements the `groovy.lang.Writable` interface that allows you to write out the config to any `java.io.Writer`:

```
def config = new ConfigSlurper().parse(..)

new File("..").withWriter { writer ->
    config.writeTo(writer)
}
```

Special "environments" Configuration

The `ConfigSlurper` class has a special constructor other than the default constructor that takes an "environment" parameter. This special constructor works in concert with a property setting called `environments`. This allows a default setting to exist in the property file that can be superceded by a setting in the appropriate environments closure. This allows multiple related configurations to be stored in the same file.

Given this groovy property file:

```
Sample.groovy

sample {
    foo = "default_foo"
    bar = "default_bar"
}

environments {
    development {
        sample {
            foo = "dev_foo"
        }
    }
    test {
        sample {
            bar = "test_bar"
        }
    }
}
```

Here is the demo code that exercises this configuration:

```
def config = new ConfigSlurper("development").parse(new File('Sample.groovy').toURL())

assert config.sample.foo == "dev_foo"
assert config.sample.bar == "default_bar"

config = new ConfigSlurper("test").parse(new File('Sample.groovy').toURL())

assert config.sample.foo == "default_foo"
assert config.sample.bar == "test_bar"
```

Note: the `environments` closure is not directly parsable. Without using the special environment constructor the closure is ignored.

Further information

[Using Groovy ConfigSlurper to Configure Spring Beans](#)

ObjectGraphBuilder

This page last changed on Nov 18, 2007 by [aalmiray](#).

ObjectGraphBuilder is a builder for an arbitrary graph of beans that follow the JavaBean convention, its useful for creating test data for example.

Let's say that the following classes belong into your domain model:

```
package com.acme

class Company {
    String name
    Address address
    List employees = []
}

class Address {
    String line1
    String line2
    int zip
    String state
}

class Employee {
    String name
    int employeeId
    Address address
    Company company
}
```

With ObjectGraphBuilder building a Company with three employees is as easy as

```
def builder = new ObjectGraphBuilder()
builder.classNameResolver = "com.acme"

def acme = builder.company( name: 'ACME' ){
    3.times {
        employee( id: it, name: 'Drone ${it}' )
    }
}

assertNotNull acme
assert acme.employees.size() == 3
```

Here is what's happening behind the scenes:

1. the builder will try to match a node name into a Class, using a default **ClassNameResolver** strategy that requires a package name.
2. then an instance of said class must be created, using a default **NewInstanceResolver** strategy that calls a no-args constructor.
3. the parent/child relationship must be resolved for nested nodes, here it gets a little tricky as two other strategies come into play. **RelationNameResolver** will yield the name of the child property in the parent, and the name of the parent property in the child (if any, in this case, Employee has a parent property aptly named 'company'). **ChildPropertySetter** will 'insert' the child into the parent taking into account if the child belongs to a Collection or not (in this case employees should be a list of Employee instances in Company).

All 4 strategies have a default implementation that work as expected if the code follows the usual conventions for writing JavaBeans. But if by any chance any of your beans does not follow the convention you may plug your own implementation of each strategy. Each strategy setter is Closure friendly, for example

```
builder.newInstanceResolver = { klass, attributes ->
    if( attributes.foo ){
        return klass.newInstance( [attributes.foo] as Object[] )
    }
}
```

```
// default no-args constructor
klass.newInstance()
}
```

ObjectGraphBuilder supports ids per node as SwingBuilder does, meaning that you can 'store' a reference to a node in the builder, this is useful to relate one instance with many others as well. Because a property named 'id' may be of business meaning in some domain models ObjectGraphBuilder has a strategy named **IdentifierResolver** that you may configure to change the default name value ('id'). The same may happen with the property used for referencing a previously saved instance, a strategy named **ReferenceResolver** will yield the appropriate value (default is 'refId'):

```
def company = builder.company( name: 'ACME' ) {
address( id: 'a1', line1: '123 Groovy Rd', zip: 12345, state: 'JV' )
employee( name: 'Duke', employeeId: 1, address: a1 )
}
```

```
def company = builder.company( name: 'ACME' ) {
address( id: 'a1', line1: '123 Groovy Rd', zip: 12345, state: 'JV' )
employee( name: 'Duke', employeeId: 1 ){
address( refId: 'a1' )
}
}
```

Its worth mentioning that you can not modify the properties of a referenced bean.

For those rare occasions where ObjectGraphBuilder can't locate your classes (it happens when you run a script using groovyConsole) you may define a classLoader for ObjectGraphBuilder to resolve classes. Try for example running the following script inside groovyConsole and then comment out the classLoader property.

```
class Conference {
String name
List speakers = []
}

class Speaker {
String name
}

def ogb = new ObjectGraphBuilder( classLoader: getClass().classLoader )
def j1 = ogb.conference( name: 'JavaOne' ) {
speaker( name: 'Duke' )
}
assert j1.speakers.size() == 1
assert j1.speakers[0].name == 'Duke'
```

ObservableMap

This page last changed on Nov 01, 2007 by [aalmiray](#).

An observable map will trigger a `PropertyChangeEvent` every time a value changes. We can convert a map into an observable one with the 'as' keyword too:

```
// don't forget the imports
import java.beans.*
def map = [:] as ObservableMap
map.addPropertyChangeListener({ evt ->
println "${evt.propertyName}: ${evt.oldValue} -> ${evt.newValue}"
} as PropertyChangeListener)

map.key = 'value' // prints key: null -> value
map.key = 'Groovy' // prints key: value -> Groovy
```

We can also wrap an existing map with an `ObservableMap`

```
import java.beans.*
def sorted = [a:1,b:2] as TreeMap
def map = new ObservableMap(sorted)
map.addPropertyChangeListener({ evt ->
println "${evt.propertyName}: ${evt.oldValue} -> ${evt.newValue}"
} as PropertyChangeListener)
map.key = 'value'
assert ['a','b','key'] == (sorted.keySet() as List)
assert ['a','b','key'] == (map.keySet() as List)
```

Lastly we can specify a closure as an additional parameter, it will work like a filter for properties that should or should not trigger a `PropertyChangeEvent` when their values change, this is useful in conjunction with `Expando`. The filtering closure may take 2 parameters (the property name and its value) or less (the value of the property).

```
import java.beans.*
def map = new ObservableMap({!(it instanceof Closure)})
map.addPropertyChangeListener({ evt ->
println "${evt.propertyName}: ${evt.oldValue} -> ${evt.newValue}"
} as PropertyChangeListener)
def bean = new Expando( map )
bean.lang = 'Groovy' // prints lang: null -> Groovy
bean.sayHello = { name -> "Hello ${name}" } // prints nothing, event is skipped
assert 'Groovy' == bean.lang
assert 'Hello Groovy' == bean.sayHello(bean.lang)
```

GUI Programming with Groovy

This page last changed on Dec 26, 2007 by [aalmiray](#).

Introduction

Groovy has several options available for writing GUI code:

- you can directly use any of the AWT and Swing classes built in to Java
- you can use any Java libraries which sit on top of or alongside Swing, e.g.:
 - JGoodies ([home](#)) ([example](#))
 - JFreeChart ([home](#)) ([example](#)) ([builder](#))
- you can use Groovy's SwingBuilder (see Further Details)
- you can use [GraphicsBuilder](#) to access Java 2D features
- you can use SwingXBuilder (see Further Details)
- you can use the [JIDE builder](#) for the open source [JIDE Common Layer](#)
- you can use the [GroovySWT](#) module
- you can use the [PrefuseBuilder](#) for creating pretty representations of graphs of objects
- you can use the [wingS](#) framework: [WingsBuilder](#) - ([example](#)) ([comparison to swing](#))

You might also consider using [FEST](#) for testing your GUI application as shown [here](#).

Further Details

- [Swing Builder](#)
 - [Alphabetical Widgets List](#)
 - [SwingBuidler.borderLayout](#)
 - [SwingBuilder.action](#)
 - [SwingBuilder.actions](#)
 - [SwingBuilder.bind](#)
 - [SwingBuilder.borderLayout](#)
 - [SwingBuilder.boundedRangeModel](#)
 - [SwingBuilder.box](#)
 - [SwingBuilder.boxLayout](#)
 - [SwingBuilder.button](#)
 - [SwingBuilder.buttonGroup](#)
 - [SwingBuilder.cardLayout](#)
 - [SwingBuilder.checkBox](#)
 - [SwingBuilder.checkBoxMenuItem](#)
 - [SwingBuilder.closureColumn](#)
 - [SwingBuilder.colorChooser](#)
 - [SwingBuilder.comboBox](#)
 - [SwingBuilder.compoundBorder](#)
 - [SwingBuilder.container](#)
 - [SwingBuilder.desktopPane](#)
 - [SwingBuilder.dialog](#)
 - [SwingBuilder.editorPane](#)
 - [SwingBuilder.emptyBorder](#)
 - [SwingBuilder.etchedBorder](#)
 - [SwingBuilder.fileChooser](#)
 - [SwingBuilder.flowLayout](#)
 - [SwingBuilder.formattedTextField](#)
 - [SwingBuilder.frame](#)
 - [SwingBuilder.gridBagConstraints](#)
 - [SwingBuilder.gridBagLayout](#)
 - [SwingBuilder.gridLayout](#)
 - [SwingBuilder.imageIcon](#)
 - [SwingBuilder.internalFrame](#)
 - [SwingBuilder.JComponent](#)
 - [SwingBuilder.label](#)
 - [SwingBuilder.layeredPane](#)
 - [SwingBuilder.lineBorder](#)
 - [SwingBuilder.list](#)
 - [SwingBuilder.loweredBevelBorder](#)

- [SwingBuilder.map](#)
- [SwingBuilder.matteBorder](#)
- [SwingBuilder.menu](#)
- [SwingBuilder.menuBar](#)
- [SwingBuilder.menuItem](#)
- [SwingBuilder.optionPane](#)
- [SwingBuilder.overlayLayout](#)
- [SwingBuilder.panel](#)
- [SwingBuilder.passwordField](#)
- [SwingBuilder.popupMenu](#)
- [SwingBuilder.progressBar](#)
- [SwingBuilder.propertyColumn](#)
- [SwingBuilder.radioButton](#)
- [SwingBuilder.radioButtonMenuItem](#)
- [SwingBuilder.raisedBevelBorder](#)
- [SwingBuilder.raisedEtchedBorder](#)
- [SwingBuilder.scrollBar](#)
- [SwingBuilder.scrollPane](#)
- [SwingBuilder.separator](#)
- [SwingBuilder.slider](#)
- [SwingBuilder.spinner](#)
- [SwingBuilder.spinnerDateModel](#)
- [SwingBuilder.spinnerListModel](#)
- [SwingBuilder.spinnerNumberModel](#)
- [SwingBuilder.splitPane](#)
- [SwingBuilder.springLayout](#)
- [SwingBuilder.tabbedPane](#)
- [SwingBuilder.table](#)
- [SwingBuilder.tableColumn](#)
- [SwingBuilder.tableLayout](#)
- [SwingBuilder.tableModel](#)
- [SwingBuilder.td](#)
- [SwingBuilder.textArea](#)
- [SwingBuilder.textField](#)
- [SwingBuilder.textPane](#)
- [SwingBuilder.titledBorder](#)
- [SwingBuilder.toggleButton](#)
- [SwingBuilder.toolBar](#)
- [SwingBuilder.tr](#)
- [SwingBuilder.tree](#)
- [SwingBuilder.viewport](#)
- [SwingBuilder.widget](#)
- [SwingBuilder.window](#)
- [Categorical Widget List](#)
- [Extending Swing Builder](#)
- [SwingXBuilder](#)
 - [Effects](#)
 - [Extending SwingXBuilder](#)
 - [Graphs](#)
 - [MultiSplitPane](#)
 - [Painters](#)
 - [Widgets and Common Attributes](#)

Swing Builder

This page last changed on Dec 07, 2007 by [dragonne](#).

Here's a simple example of using SwingBuilder:

```
import groovy.swing.SwingBuilder
import java.awt.BorderLayout
def swing = new SwingBuilder()
count = 0
def textlabel
def frame =
swing.frame(title:'Frame', size:[300,300]) {
borderLayout()
textlabel = label(text:"Clicked ${count} time(s).",
constraints: BorderLayout.NORTH)
button(text:'Click Me',
actionPerformed: {count++; textlabel.text = "Clicked ${count} time(s)."; println "clicked"},
constraints:BorderLayout.SOUTH)
}
frame.pack()
frame.show()
```

Here is a slightly more involved example, with an example of swing builder code re-use via a closure.

```
import groovy.swing.SwingBuilder
import javax.swing.*
import java.awt.*

def swing = new SwingBuilder()

def sharedPanel = {
swing.panel() {
label("Shared Panel")
}
}

count = 0
def textlabel
def frame =
swing.frame(title:'Frame', size:[300,300], defaultCloseOperation:JFrame.EXIT_ON_CLOSE, pack:true,
show:true) {
boxLayout(axis:BoxLayout.Y_AXIS)
textlabel = label(text:"Clicked ${count} time(s).",
constraints: BorderLayout.NORTH)
button(text:'Click Me',
actionPerformed: {count++; textlabel.text = "Clicked ${count} time(s)."; println "clicked"},
constraints:BorderLayout.SOUTH)
widget(sharedPanel())
widget(sharedPanel())
}
}
```

- [Alphabetical Widgets List](#)
- [Categorical Widget List](#)
- [Extending Swing Builder](#)

Alphabetical Widgets List

This page last changed on Mar 21, 2008 by [shemnon](#).

Element	Principal Java Class	Notes
action	javax.swing.Action	
actions	java.util.Collection	
bind	org.codehaus.groovy.binding.FullBinding	Used to bind attribute to other bean properties
borderLayout	java.awt.BorderLayout	
boundedRangeModel	javax.swing.DefaultBoundedRangeModel	
box	javax.swing.Box	
boxLayout	javax.swing.BoxLayout	
button	javax.swing.JButton	
buttonGroup	javax.swing.ButtonGroup	
cardLayout	java.awt.CardLayout	
checkBox	javax.swing.JCheckBox	
checkBoxMenuItem	javax.swing.JCheckBoxMenuItem	
closureColumn	groovy.model.DefaultTableColumn	
compoundBorder	javax.swing.border.CompoundBorder	
colorChooser	javax.swing.JColorChooser	
comboBox	javax.swing.JComboBox	
container		placeholder for external container widget
desktopPane	javax.swing.JDesktopPane	
dialog	javax.swing.JDialog	
editorPane	javax.swing.JEditorPane	
emptyBorder	javax.swing.border.EmptyBorder	
etchedBorder	javax.swing.border.EtchedBorder	
fileChooser	javax.swing.JFileChooser	
flowLayout	java.awt.FlowLayout	
formattedTextField	javax.swing.JFormattedTextField	
frame	javax.swing.JFrame	
gbc	java.awt.GridBagConstraints	alias for gridBagConstraintss
glue		calls Box.createGlue()

gridBagConstraints	java.awt.GridBagConstraints	
gridBagLayout	java.awt.GridBagLayout	
gridLayout	java.awt.GridLayout	
hbox		calls Box.createHorizontalBox()
hglue		calls Box.createHorizontalGlue()
hstrut		calls Box.createHorizontalStrut()
internalFrame	javax.swing.JInternalFrame	
imageIcon	javax.swing.ImageIcon	
label	javax.swing.JLabel	
layeredPane	javax.swing.JLayeredPane	
lineBorder	javax.swing.border.LineBorder	
list	javax.swing.JList	
loweredBevelBorder	javax.swing.border.BevelBorder	
loweredEtchedBorder	javax.swing.border.EtchedBorder	
map	java.util.Map	returns the attributes
matteBorder	javax.swing.border.MatteBorder	
menu	javax.swing.JMenu	
menuBar	javax.swing.JMenuBar	
menuItem	javax.swing.JMenuItem	
optionPane	javax.swing.JOptionPane	
overlayLayout	javax.swing.OverlayLayout	
panel	javax.swing.JPanel	
passwordField	javax.swing.JPasswordField	
popupMenu	javax.swing.JPopupMenu	
progressBar	javax.swing.JProgressBar	
propertyColumn	groovy.model.DefaultTableColumn	
radioButton	javax.swing.JRadioButton	
raisedBevelBorder	javax.swing.border.BevelBorder	
raisedEtchedBorder	javax.swing.border.EtchedBorder	
radioButtonMenuItem	javax.swing.JRadioButtonMenuItem	
rigidArea		calls Box.createRigidArea()
scrollBar	javax.swing.JScrollBar	

scrollPane	javax.swing.JScrollPane	
separator	javax.swing.JSeparator	
slider	javax.swing.JSlider	
spinner	javax.swing.JSpinner	
spinnerDateModel	javax.swing.SpinnerDateModel	
spinnerListModel	javax.swing.SpinnerListModel	
spinnerNumberModel	javax.swing.SpinnerNumberModel	
splitPane	javax.swing.JSplitPane	
springLayout	javax.swing.SpringLayout	
tabbedPane	javax.swing.JTabbedPane	
table	javax.swing.JTable	
tableColumn	javax.swing.table.TableColumn	
tableLayout	groovy.swing.impl.TableLayout	
tableModel	javax.swing.table.TableModel	can pass value through
td	groovy.swing.impl.TableLayoutCell	
textArea	javax.swing.JTextArea	
textField	javax.swing.JTextField	
textPane	javax.swing.JTextPane	
titledBorder	javax.swing.border.TitledBorder	
toggleButton	javax.swing.JToggleButton	
toolBar	javax.swing.JToolBar	
tr	groovy.swing.impl.TableLayoutRow	
tree	javax.swing.JTree	
vbox		calls Box.createVerticleBox()
vglue		calls Box.createVerticleGlue()
viewport	javax.swing.JViewport	
vstrut		calls Box.createVerticleStrut()
widget		pass through, should have no child content
window	javax.swing.JWindow	

SwingBuidler.borderLayout

This page last changed on Mar 21, 2008 by [shemnon](#).

(Automatically generated from BeanInfo)

Generated Object

A `java.awt.BorderLayout` is returned, unless the user passes in a subclass of `BorderLayout` as the value argument, in which case the value argument is returned.

Attributes

Declared in `java.awt.BorderLayout`

* `hgap` <int>
* `vgap` <int>

Events

Content

Usage

Examples

Observable Attributes

SwingBuilder.action

This page last changed on Oct 29, 2007 by [shemnon](#).

Generated Object

A javax.swing.Action object, of some sort.

Value Argument

A pre-existing javax.swing.Action instance can be provided. In this cases the attributes will be applied to that action instead of creating a new groovy.swing.impl.DefaultAction.

Attributes

- **closure** <Closure> The action to be performed when the actionPerformed method is called. The actionPerformed will be the only parameter passed in.
- **name** <String> The name to be shown on a button or menu item
- **shortDescription** <String> The text to be displayed as a button's tool tip
- **smallIcon** <String> The icon shown on the button or menu item
- **actionCommandKey** <String> Sets the actionCommand on the button or menu item
- **accelerator** <String> or <KeyStroke> The keyboard accelerator for a menu item to associate with this action
- **mnemonic** <char> or <String> The mnemonic for the action in the button or menu item
- **enabled** <boolean> Whether this action is enabled. Will be reflected in enabled state of button or menu item

unused Action magic values

- **longDescription** <String> Intended for context sensitive help (like a status bar).

Content

No content is accepted by an action() node.

Usage

Actions are the lifeblood of a full fledged swing application. [Other sources](#) can expound on their usefulness.

Examples

```
//TBD
```

SwingBuilder.actions

This page last changed on Mar 21, 2008 by [shemnon](#).

(Automatically generated from BeanInfo)

Generated Object

A `java.util.Collection` is returned, unless the user passes in a subclass of `Collection` as the value argument, in which case the value argument is returned.

Attributes

Declared in `java.util.Collection`

- **empty** <boolean>

Events

Content

Usage

Examples

Observable Attributes

SwingBuilder.bind

This page last changed on Mar 27, 2008 by [shemnon](#).

Generated Object

An internal class that currently should not be relied on.

Attributes

- **source** <Object> The object that triggers the binding update
- **sourceProperty** <String> A property that is read for the update and whose change triggers the update
- **sourceEvent** <String> The event name trigger an update
- **sourceValue** <Closure> A closure providing the value when sourceEvent triggers
- **target** <Object> The object to be updated when a bound value changes
- **targetProperty** <String> The property on the target update to which the queried value will be written
- **validator** <Closure> If the closure returns null or Boolean.FALSE then a triggered binding will be canceled
- **converter** <Closure> Takes the queried value and converts it to another object to be written to the targetProperty. The queried value is passed in "it" to the closure.

Content

bind accepts no content

Usage

bind can be used as a stand alone element or as a value for any attribute of any object.

When used as an attribute value the target and targetProperty values implicitly become the current object being constructed and the property being written to.

Until the external API is finalized, it is not recommended to use the object returned from *bind*

Examples

Example binding one property to another:

```
swing.frame() {
  panel {
    textField('Change Me!', id:'tf')
    button(text: bind(source:tf, sourceProperty:'text'))
  }
}
```

Example when triggering on a particular event with a value closure

```
swing.frame() {
  panel {
    textField('Change Me!', id:'tf')
    button(text: bind(source:tf.document, sourceEvent:'undoableEditHappened',
    sourceValue:{System.currentTimeMillis()}))
  }
}
```

Note that the source value can get any arbitrary value.

Example with validator and converter:

```
swing.frame() {
panel
{
textField('Change Me!', id:'tf')
button(text: bind(source:tf, sourceProperty:'text',
validator: { tf.text.length() >= 1}, converter: { it.toLowerCase() } ))
}
}
```

In this example the validator prevents the button text from having less than 1 char and the converter makes the button text all lowercase.

Note: Tested on Groovy 1.5.1

SwingBuilder.borderLayout

This page last changed on Mar 21, 2008 by [shemnon](#).

(Automatically generated from BeanInfo)

Generated Object

A `java.awt.BorderLayout` is returned, unless the user passes in a subclass of `BorderLayout` as the value argument, in which case the value argument is returned.

Attributes

Declared in `java.awt.BorderLayout`

- `hgap` <int>
- `vgap` <int>

Events

Content

Usage

Examples

Observable Attributes

SwingBuilder.boundedRangeModel

This page last changed on Mar 21, 2008 by [shemnon](#).

(Automatically generated from BeanInfo)

Generated Object

A `javax.swing.DefaultBoundedRangeModel` is returned, unless the user passes in a subclass of `DefaultBoundedRangeModel` as the value argument, in which case the value argument is returned.

Attributes

Declared in `javax.swing.DefaultBoundedRangeModel`

- **extent** <int>
- **maximum** <int>
- **minimum** <int>
- **value** <int>
- **valueIsAdjusting** <boolean>

Events

Declared in `javax.swing.DefaultBoundedRangeModel`

- **stateChanged** (`ChangeEvent`) - part of `ChangeListener`

Content

Usage

Examples

Observable Attributes

SwingBuilder.box

This page last changed on Mar 21, 2008 by [shemnon](#).

- [Generated Object](#)
- [Attributes](#)
- [Events](#)
- [Content](#)
- [Usage](#)
- [Examples](#)
- [Observable Attributes](#)

(Automatically generated from BeanInfo)

Generated Object

A `javax.swing.Box` is returned, unless the user passes in a subclass of `Box` as the value argument, in which case the value argument is returned.

Attributes

Declared in `javax.swing.JComponent`

- **autoscrolls** <boolean> Determines if this component automatically scrolls its contents when dragged.
- **border** <Border> The component's border.
- **componentPopupMenu** <JPopupMenu> Popup to show
- **debugGraphicsOptions** <int> Diagnostic options for graphics operations.
- **inheritsPopupMenu** <boolean> Whether or not the JPopupMenu is inherited
- **inputVerifier** <InputVerifier> The component's input verifier.
- **opaque** <boolean> The component's opacity
- **toolTipText** <String> The text to display in a tool tip.
- **transferHandler** <TransferHandler> Mechanism for transfer of data to and from the component
- **verifyInputWhenFocusTarget** <boolean> Whether the Component verifies input before accepting focus.

- **UIClassID** <String>
- **accessibleContext** <AccessibleContext>
- **actionMap** <ActionMap>
- **doubleBuffered** <boolean>
- **graphics** <Graphics>
- **height** <int>
- **managingFocus** <boolean>
- **nextFocusableComponent** <Component>
- **optimizedDrawingEnabled** <boolean>
- **paintingTile** <boolean>
- **registeredKeyStrokes** <KeyStroke[]>
- **requestFocusEnabled** <boolean>
- **rootPane** <JRootPane>
- **topLevelAncestor** <Container>
- **validateRoot** <boolean>
- **visibleRect** <Rectangle>
- **width** <int>
- **x** <int>
- **y** <int>

Declared in `java.awt.Container`

- **alignmentX** <float>
- **alignmentY** <float>
- **componentCount** <int>
- **components** <Component[]>
- **focusCycleRoot** <boolean>

- **focusTraversalPolicy** <FocusTraversalPolicy>
- **focusTraversalPolicyProvider** <boolean>
- **focusTraversalPolicySet** <boolean>
- **insets** <Insets>
- **layout** <LayoutManager>
- **maximumSize** <Dimension>
- **minimumSize** <Dimension>
- **preferredSize** <Dimension>

Declared in java.awt.Component

- **background** <Color>
- **enabled** <boolean>
- **focusable** <boolean>
- **font**
- **foreground** <Color>
- **name** <String>
- **visible** <boolean>

Events

Declared in javax.swing.JComponent

- **vetoableChange** (PropertyChangeEvent) - part of VetoableChangeListener
- **ancestorMoved** (AncestorEvent) - part of AncestorListener
- **ancestorAdded** (AncestorEvent) - part of AncestorListener
- **ancestorRemoved** (AncestorEvent) - part of AncestorListener

Declared in java.awt.Container

- **componentAdded** (ContainerEvent) - part of ContainerListener
- **componentRemoved** (ContainerEvent) - part of ContainerListener

Declared in java.awt.Component

- **keyPressed** (KeyEvent) - part of KeyListener
- **keyReleased** (KeyEvent) - part of KeyListener
- **keyTyped** (KeyEvent) - part of KeyListener
- **componentHidden** (ComponentEvent) - part of ComponentListener
- **componentMoved** (ComponentEvent) - part of ComponentListener
- **componentResized** (ComponentEvent) - part of ComponentListener
- **componentShown** (ComponentEvent) - part of ComponentListener
- **hierarchyChanged** (HierarchyEvent) - part of HierarchyListener
- **mouseClicked** (MouseEvent) - part of MouseListener
- **mouseEntered** (MouseEvent) - part of MouseListener
- **mouseExited** (MouseEvent) - part of MouseListener
- **mousePressed** (MouseEvent) - part of MouseListener
- **mouseReleased** (MouseEvent) - part of MouseListener
- **mouseDragged** (MouseEvent) - part of MouseMotionListener
- **mouseMoved** (MouseEvent) - part of MouseMotionListener
- **propertyChange** (PropertyChangeEvent) - part of PropertyChangeListener
- **ancestorMoved** (HierarchyEvent) - part of HierarchyBoundsListener
- **ancestorResized** (HierarchyEvent) - part of HierarchyBoundsListener
- **focusGained** (FocusEvent) - part of FocusListener
- **focusLost** (FocusEvent) - part of FocusListener
- **mouseWheelMoved** (MouseEvent) - part of MouseWheelListener
- **caretPositionChanged** (InputMethodEvent) - part of InputMethodListener
- **inputMethodTextChanged** (InputMethodEvent) - part of InputMethodListener

Content

Usage

Examples

Observable Attributes

- alignmentX
- alignmentY
- background
- border
- component
- componentCount
- componentPopupMenu
- components
- containerListeners
- enabled
- focusCycleRoot
- focusTraversalKeys
- focusTraversalPolicy
- focusTraversalPolicyProvider
- focusTraversalPolicySet
- focusable
- font
- foreground
- inheritsPopupMenu
- inputVerifier
- insets
- layout
- maximumSize
- minimumSize
- opaque
- preferredSize
- transferHandler
- verifyInputWhenFocusTarget

SwingBuilder.boxLayout

This page last changed on Mar 21, 2008 by [shemnon](#).

- [Generated Object](#)
- [Attributes](#)
- [Events](#)
- [Content](#)
- [Usage](#)
- [Examples](#)

(Automatically generated from BeanInfo)

Generated Object

A `javax.swing.BoxLayout` is returned, unless the user passes in a subclass of `BoxLayout` as the value argument, in which case the value argument is returned.

Attributes

Events

Content

Usage

Examples

SwingBuilder.button

This page last changed on Nov 01, 2007 by [shemnon](#).

Generated Object

A `javax.swing.JButton` is returned, unless the user passes in a subclass of `JButton` as the value argument, in which case the value argument is returned.

Attributes

See also: [JComponent](#)

Declared in JButton

- `defaultButton` <boolean> Whether or not this button is the default button
- `defaultCapable` <boolean> Whether or not this button can be the default button

Declared in AbstractButton

- `action` <Action> the Action instance connected with this ActionEvent source
- `actionCommand` <String> actionCommand
- `model` <ButtonModel> Model that the Button uses.
- `multiClickThreshold` <long> multiClickThreshold
- `selected` <boolean> selected

Text related

- `text` <String> The button's text.
- `label` <String> Replace by `setText(text)`
- `mnemonic` <int> the keyboard character mnemonic
- `displayedMnemonicIndex` <int> the index into the String to draw the keyboard character mnemonic at
- `horizontalTextPosition` <int> The horizontal position of the text relative to the icon.
- `verticalTextPosition` <int> The vertical position of the text relative to the icon.

Rendering related

- `borderPainted` <boolean> Whether the border should be painted.
- `contentAreaFilled` <boolean> Whether the button should paint the content area or leave it transparent.
- `focusPainted` <boolean> Whether focus should be painted
- `rolloverEnabled` <boolean> Whether rollover effects should be enabled.
- `margin` <Insets> The space between the button's border and the label
- `iconTextGap` <int> If both the icon and text properties are set, this property defines the space between them.

Icon related

- `icon` <Icon> The button's default icon
- `disabledIcon` <Icon> The disabled icon for the button.
- `pressedIcon` <Icon> The pressed icon for the button.
- `rolloverIcon` <Icon> The rollover icon for the button.
- `selectedIcon` <Icon> The selected icon for the button.
- `disabledSelectedIcon` <Icon> The disabled selection icon for the button.
- `rolloverSelectedIcon` <Icon> The rollover selected icon for the button.

Alignment Related

- `horizontalAlignment` <int> The horizontal alignment of the icon and text.
- `verticalAlignment` <int> The vertical alignment of the icon and text.

Content

No child content is accepted in a button.

Usage

button creates a slider-bar type widget.
//TODO add an image
//TODO describe how to fire code on a button press

The selected property is not very interesting for the Button class, as it is not user changeable. This is mostly a leaky abstraction for checkBox and radioButton

Examples

//TODO

Observable Attributes

- defaultCapable
- selected - via synthetic observation
- action
- borderPainted
- contentAreaFilled
- disabledIcon
- disabledSelectedIcon
- displayedMnemonicIndex
- focusPainted
- hideActionText
- horizontalAlignment
- horizontalTextPosition
- icon
- iconTextGap
- label
- margin
- mnemonic
- model
- pressedIcon
- rolloverEnabled
- rolloverIcon
- rolloverSelectedIcon
- selectedIcon
- text
- verticalAlignment
- verticalTextPosition

SwingBuilder.buttonGroup

This page last changed on Mar 21, 2008 by [shemnon](#).

- [Generated Object](#)
- [Attributes](#)
- [Events](#)
- [Content](#)
- [Usage](#)
- [Examples](#)

(Automatically generated from BeanInfo)

Generated Object

A `javax.swing.ButtonGroup` is returned, unless the user passes in a subclass of `ButtonGroup` as the value argument, in which case the value argument is returned.

Attributes

Declared in `javax.swing.ButtonGroup`

- **buttonCount** <int>
- **elements** <Enumeration>
- **selection** <ButtonModel>

Events

Content

Usage

Examples

SwingBuilder.cardLayout

This page last changed on Mar 21, 2008 by [shemnon](#).

- [Generated Object](#)
- [Attributes](#)
- [Events](#)
- [Content](#)
- [Usage](#)
- [Examples](#)

(Automatically generated from BeanInfo)

Generated Object

A `java.awt.CardLayout` is returned, unless the user passes in a subclass of `CardLayout` as the value argument, in which case the value argument is returned.

Attributes

Declared in `java.awt.CardLayout`

- `hgap` <int>
- `vgap` <int>

Events

Content

Usage

Examples

SwingBuilder.checkBox

This page last changed on Nov 01, 2007 by [shemnon](#).

Generated Object

A `javax.swing.JCheckBox` is returned, unless the user passes in a subclass of `JCheckBox` as the value argument, in which case the value argument is returned.

Attributes

See also: [JComponent](#)

Declared in JCheckBox

- `borderPaintedFlat` <boolean> Whether the border is painted flat.

Declared in AbstractButton

- `selected` <boolean> If the checkbox is currently selected
- `action` <Action> the Action instance connected with this ActionEvent source
- `actionCommand` <String> actionCommand
- `model` <ButtonModel> Model that the Button uses.
- `multiClickThreshold` <long> multiClickThreshold

Text related

- `text` <String> The button's text.
- `label` <String> Replace by `setText(text)`
- `mnemonic` <int> the keyboard character mnemonic
- `displayedMnemonicIndex` <int> the index into the String to draw the keyboard character mnemonic at
- `horizontalTextPosition` <int> The horizontal position of the text relative to the icon.
- `verticalTextPosition` <int> The vertical position of the text relative to the icon.

Rendering related

- `borderPainted` <boolean> Whether the border should be painted.
- `contentAreaFilled` <boolean> Whether the button should paint the content area or leave it transparent.
- `focusPainted` <boolean> Whether focus should be painted
- `rolloverEnabled` <boolean> Whether rollover effects should be enabled.
- `margin` <Insets> The space between the button's border and the label
- `iconTextGap` <int> If both the icon and text properties are set, this property defines the space between them.

Icon related

- `icon` <Icon> The button's default icon. The Icon is the checkbox in the unselected state. Set it to null to get the platform default.
- `disabledIcon` <Icon> The disabled icon for the button.
- `pressedIcon` <Icon> The pressed icon for the button.
- `rolloverIcon` <Icon> The rollover icon for the button.
- `selectedIcon` <Icon> The selected icon for the button. The Icon is the checkbox in the selected state. Set it to null to get the platform default.
- `disabledSelectedIcon` <Icon> The disabled selection icon for the button.
- `rolloverSelectedIcon` <Icon> The rollover selected icon for the button.

Alignment Related

- `horizontalAlignment` <int> The horizontal alignment of the icon and text.
- `verticalAlignment` <int> The vertical alignment of the icon and text.

Content

No child content is accepted in a checkBox.

Usage

checkBox creates a visual toggling checkbox type widget.

//TODO add an image

Examples

//TODO

Observable Attributes

- borderPaintedFlat
- selected - via synthetic observation
- action
- borderPainted
- contentAreaFilled
- disabledIcon
- disabledSelectedIcon
- displayedMnemonicIndex
- focusPainted
- hideActionText
- horizontalAlignment
- horizontalTextPosition
- icon
- iconTextGap
- label
- margin
- mnemonic
- model
- pressedIcon
- rolloverEnabled
- rolloverIcon
- rolloverSelectedIcon
- selectedIcon
- text
- verticalAlignment
- verticalTextPosition

SwingBuilder.checkBoxMenuItem

This page last changed on Mar 21, 2008 by [shemnon](#).

- [Generated Object](#)
- [Attributes](#)
- [Events](#)
- [Content](#)
- [Usage](#)
- [Examples](#)
- [Observable Attributes](#)

(Automatically generated from BeanInfo)

Generated Object

A `javax.swing.JCheckBoxMenuItem` is returned, unless the user passes in a subclass of `JCheckBoxMenuItem` as the value argument, in which case the value argument is returned.

Attributes

Declared in `javax.swing.JCheckBoxMenuItem`

- **state** <boolean> The selection state of the check box menu item

Declared in `javax.swing.JMenuItem`

- **accelerator** <KeyStroke> The keystroke combination which will invoke the `JMenuItem`'s actionlisteners without navigating the menu hierarchy
- **armed** <boolean> Mouse release will fire an action event
- **subElements** <MenuElement[]>

Declared in `javax.swing.AbstractButton`

- **UI** <ButtonUI> The UI object that implements the LookAndFeel.
- **action** <Action> the Action instance connected with this ActionEvent source
- **borderPainted** <boolean> Whether the border should be painted.
- **contentAreaFilled** <boolean> Whether the button should paint the content area or leave it transparent.
- **disabledIcon** <Icon> The disabled icon for the button.
- **disabledSelectedIcon** <Icon> The disabled selection icon for the button.
- **displayedMnemonicIndex** <int> the index into the String to draw the keyboard character mnemonic at
- **focusPainted** <boolean> Whether focus should be painted
- **horizontalAlignment** <int> The horizontal alignment of the icon and text.
- **horizontalTextPosition** <int> The horizontal position of the text relative to the icon.
- **icon** <Icon> The button's default icon
- **iconTextGap** <int> If both the icon and text properties are set, this property defines the space between them.
- **label** <String> Replace by `setText(text)`
- **margin** <Insets> The space between the button's border and the label.
- **mnemonic** <int> the keyboard character mnemonic
- **model** <ButtonModel> Model that the Button uses.
- **pressedIcon** <Icon> The pressed icon for the button.
- **rolloverEnabled** <boolean> Whether rollover effects should be enabled.
- **rolloverIcon** <Icon> The rollover icon for the button.
- **rolloverSelectedIcon** <Icon> The rollover selected icon for the button.
- **selectedIcon** <Icon> The selected icon for the button.
- **text** <String> The button's text.
- **verticalAlignment** <int> The vertical alignment of the icon and text.
- **verticalTextPosition** <int> The vertical position of the text relative to the icon.

- **actionCommand** <String>
- **multiClickThreshold** <long>
- **selected** <boolean>
- **selectedObjects** <Object[]>

Declared in javax.swing.JComponent

- **autoscrolls** <boolean> Determines if this component automatically scrolls its contents when dragged.
- **border** <Border> The component's border.
- **componentPopupMenu** <JPopupMenu> Popup to show
- **debugGraphicsOptions** <int> Diagnostic options for graphics operations.
- **inheritsPopupMenu** <boolean> Whether or not the JPopupMenu is inherited
- **inputVerifier** <InputVerifier> The component's input verifier.
- **opaque** <boolean> The component's opacity
- **toolTipText** <String> The text to display in a tool tip.
- **transferHandler** <TransferHandler> Mechanism for transfer of data to and from the component
- **verifyInputWhenFocusTarget** <boolean> Whether the Component verifies input before accepting focus.
- **UIClassID** <String>
- **accessibleContext** <AccessibleContext>
- **actionMap** <ActionMap>
- **doubleBuffered** <boolean>
- **graphics** <Graphics>
- **height** <int>
- **managingFocus** <boolean>
- **nextFocusableComponent** <Component>
- **optimizedDrawingEnabled** <boolean>
- **paintingTile** <boolean>
- **registeredKeyStrokes** <KeyStroke[]>
- **requestFocusEnabled** <boolean>
- **rootPane** <JRootPane>
- **topLevelAncestor** <Container>
- **validateRoot** <boolean>
- **visibleRect** <Rectangle>
- **width** <int>
- **x** <int>
- **y** <int>

Declared in java.awt.Container

- **alignmentX** <float>
- **alignmentY** <float>
- **componentCount** <int>
- **components** <Component[]>
- **focusCycleRoot** <boolean>
- **focusTraversalPolicy** <FocusTraversalPolicy>
- **focusTraversalPolicyProvider** <boolean>
- **focusTraversalPolicySet** <boolean>
- **insets** <Insets>
- **layout** <LayoutManager>
- **maximumSize** <Dimension>
- **minimumSize** <Dimension>
- **preferredSize** <Dimension>

Declared in java.awt.Component

- **background** <Color>
- **enabled** <boolean>
- **focusable** <boolean>
- **font**
- **foreground** <Color>

- **name** <String>
- **visible** <boolean>

Events

Declared in `javax.swing.JMenuItem`

- **menuKeyPressed** (MenuKeyEvent) - part of MenuKeyListener
- **menuKeyReleased** (MenuKeyEvent) - part of MenuKeyListener
- **menuKeyTyped** (MenuKeyEvent) - part of MenuKeyListener
- **menuDragMouseDragged** (MenuDragMouseEvent) - part of MenuDragMouseListener
- **menuDragMouseEntered** (MenuDragMouseEvent) - part of MenuDragMouseListener
- **menuDragMouseExited** (MenuDragMouseEvent) - part of MenuDragMouseListener
- **menuDragMouseReleased** (MenuDragMouseEvent) - part of MenuDragMouseListener

Declared in `javax.swing.AbstractButton`

- **itemStateChanged** (ItemEvent) - part of ItemListener
- **actionPerformed** (ActionEvent) - part of ActionListener
- **stateChanged** (ChangeEvent) - part of ChangeListener

Declared in `javax.swing.JComponent`

- **vetoableChange** (PropertyChangeEvent) - part of VetoableChangeListener
- **ancestorMoved** (AncestorEvent) - part of AncestorListener
- **ancestorAdded** (AncestorEvent) - part of AncestorListener
- **ancestorRemoved** (AncestorEvent) - part of AncestorListener

Declared in `java.awt.Container`

- **componentAdded** (ContainerEvent) - part of ContainerListener
- **componentRemoved** (ContainerEvent) - part of ContainerListener

Declared in `java.awt.Component`

- **keyPressed** (KeyEvent) - part of KeyListener
- **keyReleased** (KeyEvent) - part of KeyListener
- **keyTyped** (KeyEvent) - part of KeyListener
- **componentHidden** (ComponentEvent) - part of ComponentListener
- **componentMoved** (ComponentEvent) - part of ComponentListener
- **componentResized** (ComponentEvent) - part of ComponentListener
- **componentShown** (ComponentEvent) - part of ComponentListener
- **hierarchyChanged** (HierarchyEvent) - part of HierarchyListener
- **mouseClicked** (MouseEvent) - part of MouseListener
- **mouseEntered** (MouseEvent) - part of MouseListener
- **mouseExited** (MouseEvent) - part of MouseListener
- **mousePressed** (MouseEvent) - part of MouseListener
- **mouseReleased** (MouseEvent) - part of MouseListener
- **mouseDragged** (MouseEvent) - part of MouseMotionListener
- **mouseMoved** (MouseEvent) - part of MouseMotionListener
- **propertyChange** (PropertyChangeEvent) - part of PropertyChangeListener
- **ancestorMoved** (HierarchyEvent) - part of HierarchyBoundsListener
- **ancestorResized** (HierarchyEvent) - part of HierarchyBoundsListener
- **focusGained** (FocusEvent) - part of FocusListener
- **focusLost** (FocusEvent) - part of FocusListener
- **mouseWheelMoved** (MouseEvent) - part of MouseWheelListener
- **caretPositionChanged** (InputMethodEvent) - part of InputMethodListener
- **inputMethodTextChanged** (InputMethodEvent) - part of InputMethodListener

Content

Usage

Examples

Observable Attributes

- UI
- accelerator
- action
- alignmentX
- alignmentY
- background
- border
- borderPainted
- componentCount
- componentPopupMenu
- components
- containerListeners
- contentAreaFilled
- disabledIcon
- disabledSelectedIcon
- displayedMnemonicIndex
- enabled
- focusCycleRoot
- focusPainted
- focusTraversalKeys
- focusTraversalPolicy
- focusTraversalPolicyProvider
- focusTraversalPolicySet
- focusable
- font
- foreground
- horizontalAlignment
- horizontalTextPosition
- icon
- iconTextGap
- inheritsPopupMenu
- inputVerifier
- insets
- label
- layout
- margin
- maximumSize
- minimumSize
- mnemonic
- model
- opaque
- preferredSize
- pressedIcon
- rolloverEnabled
- rolloverIcon
- rolloverSelectedIcon
- selectedIcon
- text
- transferHandler
- verifyInputWhenFocusTarget
- verticalAlignment
- verticalTextPosition

SwingBuilder.closureColumn

This page last changed on Mar 21, 2008 by [shemnon](#).

- [Generated Object](#)
- [Attributes](#)
- [Events](#)
- [Content](#)
- [Usage](#)
- [Examples](#)
- [Observable Attributes](#)

(Automatically generated from BeanInfo)

Generated Object

A `groovy.model.DefaultTableColumn` is returned, unless the user passes in a subclass of `DefaultTableColumn` as the value argument, in which case the value argument is returned.

Attributes

Declared in `groovy.model.DefaultTableColumn`

- **type** <Class>
- **valueModel** <ValueModel>

Declared in `javax.swing.table.TableColumn`

- **cellEditor** <TableCellEditor>
- **cellRenderer** <TableCellRenderer>
- **headerRenderer** <TableCellRenderer>
- **headerValue** <Object>
- **identifier** <Object>
- **maxWidth** <int>
- **minWidth** <int>
- **modelIndex** <int>
- **preferredWidth** <int>
- **resizable** <boolean>
- **width** <int>

Events

Declared in `javax.swing.table.TableColumn`

- **propertyChange** (PropertyChangeEvent) - part of PropertyChangeListener

Content

Usage

Examples

```
table {
  tableModel(list:listOfItems) {
    closureColumn(
      header:'Location',
      read: {row -> return row.location},
      write: {row, newValue -> println "write: $row new value: $newValue"}
    )
  }
}
```

Observable Attributes

- cellEditor
- cellRenderer
- headerRenderer
- headerValue
- identifier
- maxWidth
- minWidth
- modelIndex
- preferredWidth
- propertyChangeListeners
- resizable
- type
- valueModel
- width

SwingBuilder.colorChooser

This page last changed on Mar 21, 2008 by [shemnon](#).

- [Generated Object](#)
- [Attributes](#)
- [Events](#)
- [Content](#)
- [Usage](#)
- [Examples](#)
- [Observable Attributes](#)

(Automatically generated from BeanInfo)

Generated Object

A `javax.swing.JColorChooser` is returned, unless the user passes in a subclass of `JColorChooser` as the value argument, in which case the value argument is returned.

Attributes

Declared in `javax.swing.JColorChooser`

- **UI** `<ColorChooserUI>` The UI object that implements the color chooser's LookAndFeel.
- **chooserPanels** `<AbstractColorChooserPanel[]>` An array of different chooser types.
- **color** `<Color>` The current color the chooser is to display.
- **dragEnabled** `<boolean>` Determines whether automatic drag handling is enabled.
- **previewPanel** `<JComponent>` The UI component which displays the current color.
- **selectionModel** `<ColorSelectionModel>` The model which contains the currently selected color.

Declared in `javax.swing.JComponent`

- **autoscrolls** `<boolean>` Determines if this component automatically scrolls its contents when dragged.
- **border** `<Border>` The component's border.
- **componentPopupMenu** `<JPopupMenu>` Popup to show
- **debugGraphicsOptions** `<int>` Diagnostic options for graphics operations.
- **inheritsPopupMenu** `<boolean>` Whether or not the JPopupMenu is inherited
- **inputVerifier** `<InputVerifier>` The component's input verifier.
- **opaque** `<boolean>` The component's opacity
- **toolTipText** `<String>` The text to display in a tool tip.
- **transferHandler** `<TransferHandler>` Mechanism for transfer of data to and from the component
- **verifyInputWhenFocusTarget** `<boolean>` Whether the Component verifies input before accepting focus.

- **UIClassID** `<String>`
- **accessibleContext** `<AccessibleContext>`
- **actionMap** `<ActionMap>`
- **doubleBuffered** `<boolean>`
- **graphics** `<Graphics>`
- **height** `<int>`
- **managingFocus** `<boolean>`
- **nextFocusableComponent** `<Component>`
- **optimizedDrawingEnabled** `<boolean>`
- **paintingTile** `<boolean>`
- **registeredKeyStrokes** `<KeyStroke[]>`
- **requestFocusEnabled** `<boolean>`
- **rootPane** `<JRootPane>`
- **topLevelAncestor** `<Container>`
- **validateRoot** `<boolean>`
- **visibleRect** `<Rectangle>`
- **width** `<int>`
- **x** `<int>`

- **y** <int>

Declared in `java.awt.Container`

- **alignmentX** <float>
- **alignmentY** <float>
- **componentCount** <int>
- **components** <Component[]>
- **focusCycleRoot** <boolean>
- **focusTraversalPolicy** <FocusTraversalPolicy>
- **focusTraversalPolicyProvider** <boolean>
- **focusTraversalPolicySet** <boolean>
- **insets** <Insets>
- **layout** <LayoutManager>
- **maximumSize** <Dimension>
- **minimumSize** <Dimension>
- **preferredSize** <Dimension>

Declared in `java.awt.Component`

- **background** <Color>
- **enabled** <boolean>
- **focusable** <boolean>
- **font**
- **foreground** <Color>
- **name** <String>
- **visible** <boolean>

Events

Declared in `javax.swing.JComponent`

- **vetoableChange** (PropertyChangeEvent) - part of VetoableChangeListener
- **ancestorMoved** (AncestorEvent) - part of AncestorListener
- **ancestorAdded** (AncestorEvent) - part of AncestorListener
- **ancestorRemoved** (AncestorEvent) - part of AncestorListener

Declared in `java.awt.Container`

- **componentAdded** (ContainerEvent) - part of ContainerListener
- **componentRemoved** (ContainerEvent) - part of ContainerListener

Declared in `java.awt.Component`

- **keyPressed** (KeyEvent) - part of KeyListener
- **keyReleased** (KeyEvent) - part of KeyListener
- **keyTyped** (KeyEvent) - part of KeyListener
- **componentHidden** (ComponentEvent) - part of ComponentListener
- **componentMoved** (ComponentEvent) - part of ComponentListener
- **componentResized** (ComponentEvent) - part of ComponentListener
- **componentShown** (ComponentEvent) - part of ComponentListener
- **hierarchyChanged** (HierarchyEvent) - part of HierarchyListener
- **mouseClicked** (MouseEvent) - part of MouseListener
- **mouseEntered** (MouseEvent) - part of MouseListener
- **mouseExited** (MouseEvent) - part of MouseListener
- **mousePressed** (MouseEvent) - part of MouseListener
- **mouseReleased** (MouseEvent) - part of MouseListener
- **mouseDragged** (MouseEvent) - part of MouseMotionListener
- **mouseMoved** (MouseEvent) - part of MouseMotionListener
- **propertyChange** (PropertyChangeEvent) - part of PropertyChangeListener
- **ancestorMoved** (HierarchyEvent) - part of HierarchyBoundsListener
- **ancestorResized** (HierarchyEvent) - part of HierarchyBoundsListener

- **focusGained** (FocusEvent) - part of FocusListener
- **focusLost** (FocusEvent) - part of FocusListener
- **mouseWheelMoved** (MouseEvent) - part of MouseWheelListener
- **caretPositionChanged** (InputMethodEvent) - part of InputMethodListener
- **inputMethodTextChanged** (InputMethodEvent) - part of InputMethodListener

Content

Usage

Examples

Observable Attributes

- UI
- alignmentX
- alignmentY
- background
- border
- chooserPanels
- component
- componentCount
- componentPopupMenu
- components
- containerListeners
- enabled
- focusCycleRoot
- focusTraversalKeys
- focusTraversalPolicy
- focusTraversalPolicyProvider
- focusTraversalPolicySet
- focusable
- font
- foreground
- inheritsPopupMenu
- inputVerifier
- insets
- layout
- maximumSize
- minimumSize
- opaque
- preferredSize
- previewPanel
- selectionModel
- transferHandler
- verifyInputWhenFocusTarget

SwingBuilder.comboBox

This page last changed on Mar 21, 2008 by [shemnon](#).

- [Generated Object](#)
- [Attributes](#)
- [Events](#)
- [Content](#)
- [Usage](#)
- [Examples](#)
- [Observable Attributes](#)

(Automatically generated from BeanInfo)

Generated Object

A `javax.swing.JComboBox` is returned, unless the user passes in a subclass of `JComboBox` as the value argument, in which case the value argument is returned.

Attributes

Declared in `javax.swing.JComboBox`

- **UI** `<ComboBoxUI>` The UI object that implements the Component's LookAndFeel.
- **action** `<Action>` the Action instance connected with this ActionEvent source
- **editable** `<boolean>` If true, the user can type a new value in the combo box.
- **editor** `<ComboBoxEditor>` The editor that combo box uses to edit the current value
- **keySelectionManager** `<KeySelectionManager>` The objects that changes the selection when a key is pressed.
- **lightWeightPopupEnabled** `<boolean>` Set to `<code>>false</code>` to require heavyweight popups.
- **maximumRowCount** `<int>` The maximum number of rows the popup should have
- **model** `<ComboBoxModel>` Model that the combo box uses to get data to display.
- **prototypeDisplayValue** `<Object>` The display prototype value, used to compute display width and height.
- **renderer** `<ListCellRenderer>` The renderer that paints the item selected in the list.
- **selectedIndex** `<int>` The item at index is selected.
- **selectedItem** `<Object>` Sets the selected item in the JComboBox.

- **actionCommand** `<String>`
- **itemCount** `<int>`
- **popupVisible** `<boolean>`
- **selectedObjects** `<Object[]>`

Declared in `javax.swing.JComponent`

- **autoscrolls** `<boolean>` Determines if this component automatically scrolls its contents when dragged.
- **border** `<Border>` The component's border.
- **componentPopupMenu** `<JPopupMenu>` Popup to show
- **debugGraphicsOptions** `<int>` Diagnostic options for graphics operations.
- **inheritsPopupMenu** `<boolean>` Whether or not the JPopupMenu is inherited
- **inputVerifier** `<InputVerifier>` The component's input verifier.
- **opaque** `<boolean>` The component's opacity
- **toolTipText** `<String>` The text to display in a tool tip.
- **transferHandler** `<TransferHandler>` Mechanism for transfer of data to and from the component
- **verifyInputWhenFocusTarget** `<boolean>` Whether the Component verifies input before accepting focus.

- **UIClassID** `<String>`
- **accessibleContext** `<AccessibleContext>`
- **actionMap** `<ActionMap>`
- **doubleBuffered** `<boolean>`
- **graphics** `<Graphics>`

- **height** <int>
- **managingFocus** <boolean>
- **nextFocusableComponent** <Component>
- **optimizedDrawingEnabled** <boolean>
- **paintingTile** <boolean>
- **registeredKeyStrokes** <KeyStroke[]>
- **requestFocusEnabled** <boolean>
- **rootPane** <JRootPane>
- **topLevelAncestor** <Container>
- **validateRoot** <boolean>
- **visibleRect** <Rectangle>
- **width** <int>
- **x** <int>
- **y** <int>

Declared in java.awt.Container

- **alignmentX** <float>
- **alignmentY** <float>
- **componentCount** <int>
- **components** <Component[]>
- **focusCycleRoot** <boolean>
- **focusTraversalPolicy** <FocusTraversalPolicy>
- **focusTraversalPolicyProvider** <boolean>
- **focusTraversalPolicySet** <boolean>
- **insets** <Insets>
- **layout** <LayoutManager>
- **maximumSize** <Dimension>
- **minimumSize** <Dimension>
- **preferredSize** <Dimension>

Declared in java.awt.Component

- **background** <Color>
- **enabled** <boolean>
- **focusable** <boolean>
- **font**
- **foreground** <Color>
- **name** <String>
- **visible** <boolean>

Events

Declared in javax.swing.JComboBox

- **itemStateChanged** (ItemEvent) - part of ItemListener
- **actionPerformed** (ActionEvent) - part of ActionListener
- **popupMenuCanceled** (PopupMenuEvent) - part of PopupMenuListener
- **popupMenuWillBecomeInvisible** (PopupMenuEvent) - part of PopupMenuListener
- **popupMenuWillBecomeVisible** (PopupMenuEvent) - part of PopupMenuListener

Declared in javax.swing.JComponent

- **vetoableChange** (PropertyChangeEvent) - part of VetoableChangeListener
- **ancestorMoved** (AncestorEvent) - part of AncestorListener
- **ancestorAdded** (AncestorEvent) - part of AncestorListener
- **ancestorRemoved** (AncestorEvent) - part of AncestorListener

Declared in java.awt.Container

- **componentAdded** (ContainerEvent) - part of ContainerListener
- **componentRemoved** (ContainerEvent) - part of ContainerListener

Declared in java.awt.Component

- **keyPressed** (KeyEvent) - part of KeyListener
- **keyReleased** (KeyEvent) - part of KeyListener
- **keyTyped** (KeyEvent) - part of KeyListener
- **componentHidden** (ComponentEvent) - part of ComponentListener
- **componentMoved** (ComponentEvent) - part of ComponentListener
- **componentResized** (ComponentEvent) - part of ComponentListener
- **componentShown** (ComponentEvent) - part of ComponentListener
- **hierarchyChanged** (HierarchyEvent) - part of HierarchyListener
- **mouseClicked** (MouseEvent) - part of MouseListener
- **mouseEntered** (MouseEvent) - part of MouseListener
- **mouseExited** (MouseEvent) - part of MouseListener
- **mousePressed** (MouseEvent) - part of MouseListener
- **mouseReleased** (MouseEvent) - part of MouseListener
- **mouseDragged** (MouseEvent) - part of MouseMotionListener
- **mouseMoved** (MouseEvent) - part of MouseMotionListener
- **propertyChange** (PropertyChangeEvent) - part of PropertyChangeListener
- **ancestorMoved** (HierarchyEvent) - part of HierarchyBoundsListener
- **ancestorResized** (HierarchyEvent) - part of HierarchyBoundsListener
- **focusGained** (FocusEvent) - part of FocusListener
- **focusLost** (FocusEvent) - part of FocusListener
- **mouseWheelMoved** (MouseEvent) - part of MouseWheelListener
- **caretPositionChanged** (InputMethodEvent) - part of InputMethodListener
- **inputMethodTextChanged** (InputMethodEvent) - part of InputMethodListener

Content

Usage

Examples

Observable Attributes

- UI
- action
- alignmentX
- alignmentY
- background
- border
- component
- componentCount
- componentPopupMenu
- components
- containerListeners
- editable
- editor
- enabled
- focusCycleRoot
- focusTraversalKeys
- focusTraversalPolicy
- focusTraversalPolicyProvider
- focusTraversalPolicySet
- focusable
- font
- foreground
- inheritsPopupMenu
- inputVerifier
- insets
- layout
- lightweightPopupMenuEnabled

- maximumRowCount
- maximumSize
- minimumSize
- model
- opaque
- preferredSize
- prototypeDisplayValue
- renderer
- transferHandler
- verifyInputWhenFocusTarget

SwingBuilder.compoundBorder

This page last changed on Oct 23, 2007 by [shemnon](#).

Generated Object

The generated object is one or more nested CompoundBorders creating a border from the supplied border.

Value Argument

The optional value argument is an array of one or more border objects. If only one border object is passed in then the result of the node is that border. Otherwise the result is one or more nested compound borders containing the borders in an outside to inside order. The compound border representing the innermost border and its parent compound will be returned.

If the value argument is used the `outerBorder:` and `innerBorder:` attribute arguments are prohibited.

Attributes

Only the simple two border compound can be created via attributes. Both `inner:` and `outer:` attributes are required.

- **outerBorder** <Border> the outside border
- **innerBorder** <Border> the inside border
- **parent** <boolean> Whether or not this border is to be added to the parent JComponent

Content

`compoundBorder()` is a leaf node, no child content is allowed.

Examples

```
panel(border: compoundBorder([emptyBorder(3), titledBorder('title')]))
```

```
panel {  
  compoundBorder(outerBorder:emptyBorder(3), insideBorder:titledBorder('title'), parent:true)  
}
```

```
compoundBorder([raisedBevelBorder(), loweredBevelBorder, etchedBorder])
```

SwingBuilder.container

This page last changed on Mar 21, 2008 by [shemnon](#).

- [Generated Object](#)
- [Attributes](#)
- [Events](#)
- [Content](#)
- [Usage](#)
- [Examples](#)
- [Observable Attributes](#)

(Automatically generated from BeanInfo)

Generated Object

A `java.awt.Container` is returned, unless the user passes in a subclass of `Container` as the value argument, in which case the value argument is returned.

Attributes

Declared in `java.awt.Container`

- **alignmentX** <float>
- **alignmentY** <float>
- **componentCount** <int>
- **components** <Component[]>
- **focusCycleRoot** <boolean>
- **focusTraversalPolicy** <FocusTraversalPolicy>
- **focusTraversalPolicyProvider** <boolean>
- **focusTraversalPolicySet** <boolean>
- **insets** <Insets>
- **layout** <LayoutManager>
- **maximumSize** <Dimension>
- **minimumSize** <Dimension>
- **preferredSize** <Dimension>

Declared in `java.awt.Component`

- **background** <Color>
- **enabled** <boolean>
- **focusable** <boolean>
- **font**
- **foreground** <Color>
- **name** <String>
- **visible** <boolean>

Events

Declared in `java.awt.Container`

- **componentAdded** (ContainerEvent) - part of ContainerListener
- **componentRemoved** (ContainerEvent) - part of ContainerListener

Declared in `java.awt.Component`

- **keyPressed** (KeyEvent) - part of KeyListener
- **keyReleased** (KeyEvent) - part of KeyListener
- **keyTyped** (KeyEvent) - part of KeyListener
- **componentHidden** (ComponentEvent) - part of ComponentListener
- **componentMoved** (ComponentEvent) - part of ComponentListener
- **componentResized** (ComponentEvent) - part of ComponentListener

- **componentShown** (ComponentEvent) - part of ComponentListener
- **hierarchyChanged** (HierarchyEvent) - part of HierarchyListener
- **mouseClicked** (MouseEvent) - part of MouseListener
- **mouseEntered** (MouseEvent) - part of MouseListener
- **mouseExited** (MouseEvent) - part of MouseListener
- **mousePressed** (MouseEvent) - part of MouseListener
- **mouseReleased** (MouseEvent) - part of MouseListener
- **mouseDragged** (MouseEvent) - part of MouseMotionListener
- **mouseMoved** (MouseEvent) - part of MouseMotionListener
- **propertyChange** (PropertyChangeEvent) - part of PropertyChangeListener
- **ancestorMoved** (HierarchyEvent) - part of HierarchyBoundsListener
- **ancestorResized** (HierarchyEvent) - part of HierarchyBoundsListener
- **focusGained** (FocusEvent) - part of FocusListener
- **focusLost** (FocusEvent) - part of FocusListener
- **mouseWheelMoved** (MouseEvent) - part of MouseWheelListener
- **caretPositionChanged** (InputMethodEvent) - part of InputMethodListener
- **inputMethodTextChanged** (InputMethodEvent) - part of InputMethodListener

Content

Usage

Examples

Observable Attributes

- alignmentX
- alignmentY
- background
- component
- componentCount
- components
- containerListeners
- focusCycleRoot
- focusTraversalKeys
- focusTraversalPolicy
- focusTraversalPolicyProvider
- focusTraversalPolicySet
- focusable
- font
- foreground
- insets
- layout
- maximumSize
- minimumSize
- preferredSize

SwingBuilder.desktopPane

This page last changed on Mar 21, 2008 by [shemnon](#).

- [Generated Object](#)
- [Attributes](#)
- [Events](#)
- [Content](#)
- [Usage](#)
- [Examples](#)
- [Observable Attributes](#)

(Automatically generated from BeanInfo)

Generated Object

A `javax.swing.JDesktopPane` is returned, unless the user passes in a subclass of `JDesktopPane` as the value argument, in which case the value argument is returned.

Attributes

Declared in `javax.swing.JDesktopPane`

- **UI** <DesktopPaneUI> The UI object that implements the Component's LookAndFeel.
- **desktopManager** <DesktopManager> Desktop manager to handle the internal frames in the desktop pane.
- **dragMode** <int> Dragging style for internal frame children.
- **allFrames** <JInternalFrame[]>
- **selectedFrame** <JInternalFrame>

Declared in `javax.swing.JComponent`

- **autoscrolls** <boolean> Determines if this component automatically scrolls its contents when dragged.
- **border** <Border> The component's border.
- **componentPopupMenu** <JPopupMenu> Popup to show
- **debugGraphicsOptions** <int> Diagnostic options for graphics operations.
- **inheritsPopupMenu** <boolean> Whether or not the JPopupMenu is inherited
- **inputVerifier** <InputVerifier> The component's input verifier.
- **opaque** <boolean> The component's opacity
- **toolTipText** <String> The text to display in a tool tip.
- **transferHandler** <TransferHandler> Mechanism for transfer of data to and from the component
- **verifyInputWhenFocusTarget** <boolean> Whether the Component verifies input before accepting focus.
- **UIClassID** <String>
- **accessibleContext** <AccessibleContext>
- **actionMap** <ActionMap>
- **doubleBuffered** <boolean>
- **graphics** <Graphics>
- **height** <int>
- **managingFocus** <boolean>
- **nextFocusableComponent** <Component>
- **optimizedDrawingEnabled** <boolean>
- **paintingTile** <boolean>
- **registeredKeyStrokes** <KeyStroke[]>
- **requestFocusEnabled** <boolean>
- **rootPane** <JRootPane>
- **topLevelAncestor** <Container>
- **validateRoot** <boolean>
- **visibleRect** <Rectangle>
- **width** <int>
- **x** <int>

- **y** <int>

Declared in `java.awt.Container`

- **alignmentX** <float>
- **alignmentY** <float>
- **componentCount** <int>
- **components** <Component[]>
- **focusCycleRoot** <boolean>
- **focusTraversalPolicy** <FocusTraversalPolicy>
- **focusTraversalPolicyProvider** <boolean>
- **focusTraversalPolicySet** <boolean>
- **insets** <Insets>
- **layout** <LayoutManager>
- **maximumSize** <Dimension>
- **minimumSize** <Dimension>
- **preferredSize** <Dimension>

Declared in `java.awt.Component`

- **background** <Color>
- **enabled** <boolean>
- **focusable** <boolean>
- **font**
- **foreground** <Color>
- **name** <String>
- **visible** <boolean>

Events

Declared in `javax.swing.JComponent`

- **vetoableChange** (PropertyChangeEvent) - part of VetoableChangeListener
- **ancestorMoved** (AncestorEvent) - part of AncestorListener
- **ancestorAdded** (AncestorEvent) - part of AncestorListener
- **ancestorRemoved** (AncestorEvent) - part of AncestorListener

Declared in `java.awt.Container`

- **componentAdded** (ContainerEvent) - part of ContainerListener
- **componentRemoved** (ContainerEvent) - part of ContainerListener

Declared in `java.awt.Component`

- **keyPressed** (KeyEvent) - part of KeyListener
- **keyReleased** (KeyEvent) - part of KeyListener
- **keyTyped** (KeyEvent) - part of KeyListener
- **componentHidden** (ComponentEvent) - part of ComponentListener
- **componentMoved** (ComponentEvent) - part of ComponentListener
- **componentResized** (ComponentEvent) - part of ComponentListener
- **componentShown** (ComponentEvent) - part of ComponentListener
- **hierarchyChanged** (HierarchyEvent) - part of HierarchyListener
- **mouseClicked** (MouseEvent) - part of MouseListener
- **mouseEntered** (MouseEvent) - part of MouseListener
- **mouseExited** (MouseEvent) - part of MouseListener
- **mousePressed** (MouseEvent) - part of MouseListener
- **mouseReleased** (MouseEvent) - part of MouseListener
- **mouseDragged** (MouseEvent) - part of MouseMotionListener
- **mouseMoved** (MouseEvent) - part of MouseMotionListener
- **propertyChange** (PropertyChangeEvent) - part of PropertyChangeListener
- **ancestorMoved** (HierarchyEvent) - part of HierarchyBoundsListener
- **ancestorResized** (HierarchyEvent) - part of HierarchyBoundsListener

- **focusGained** (FocusEvent) - part of FocusListener
- **focusLost** (FocusEvent) - part of FocusListener
- **mouseWheelMoved** (MouseEvent) - part of MouseWheelListener
- **caretPositionChanged** (InputMethodEvent) - part of InputMethodListener
- **inputMethodTextChanged** (InputMethodEvent) - part of InputMethodListener

Content

Usage

Examples

Observable Attributes

- UI
- alignmentX
- alignmentY
- background
- border
- component
- componentCount
- componentPopupMenu
- components
- containerListeners
- desktopManager
- dragMode
- enabled
- focusCycleRoot
- focusTraversalKeys
- focusTraversalPolicy
- focusTraversalPolicyProvider
- focusTraversalPolicySet
- focusable
- font
- foreground
- inheritsPopupMenu
- inputVerifier
- insets
- layout
- maximumSize
- minimumSize
- opaque
- preferredSize
- transferHandler
- verifyInputWhenFocusTarget

SwingBuilder.dialog

This page last changed on Mar 21, 2008 by [shemnon](#).

- [Generated Object](#)
- [Attributes](#)
- [Events](#)
- [Content](#)
- [Usage](#)
- [Examples](#)
- [Observable Attributes](#)

(Automatically generated from BeanInfo)

Generated Object

A `javax.swing.JDialog` is returned, unless the user passes in a subclass of `JDialog` as the value argument, in which case the value argument is returned.

Attributes

Declared in `javax.swing.JDialog`

- **JMenuBar** <JMenuBar> The menubar for accessing pulldown menus from this dialog.
- **contentPane** <Container> The client area of the dialog where child components are normally inserted.
- **defaultCloseOperation** <int> The dialog's default close operation.
- **glassPane** <Component> A transparent pane used for menu rendering.
- **layeredPane** <JLayeredPane> The pane which holds the various dialog layers.
- **rootPane** <JRootPane> the `RootPane` object for this dialog.

Declared in `java.awt.Dialog`

- **modal** <boolean>
- **resizable** <boolean>
- **title** <String>
- **undecorated** <boolean>

Declared in `java.awt.Window`

- **accessibleContext** <AccessibleContext>
- **active** <boolean>
- **alwaysOnTop** <boolean>
- **bufferStrategy** <BufferStrategy>
- **cursor** <Cursor>
- **focusCycleRootAncestor** <Container>
- **focusOwner** <Component>
- **focusableWindow** <boolean>
- **focusableWindowState** <boolean>
- **focused** <boolean>
- **graphicsConfiguration** <GraphicsConfiguration>
- **inputContext** <InputContext>
- **locale** <Locale>
- **locationByPlatform** <boolean>
- **locationRelativeTo** <Component>
- **mostRecentFocusOwner** <Component>
- **ownedWindows** <Window[]>
- **owner** <Window>
- **showing** <boolean>
- **toolkit** <Toolkit>
- **warningString** <String>

Declared in java.awt.Container

- **alignmentX** <float>
- **alignmentY** <float>
- **componentCount** <int>
- **components** <Component[]>
- **focusCycleRoot** <boolean>
- **focusTraversalPolicy** <FocusTraversalPolicy>
- **focusTraversalPolicyProvider** <boolean>
- **focusTraversalPolicySet** <boolean>
- **insets** <Insets>
- **layout** <LayoutManager>
- **maximumSize** <Dimension>
- **minimumSize** <Dimension>
- **preferredSize** <Dimension>

Declared in java.awt.Component

- **background** <Color>
- **enabled** <boolean>
- **focusable** <boolean>
- **font**
- **foreground** <Color>
- **name** <String>
- **visible** <boolean>

Events

Declared in java.awt.Window

- **windowStateChanged** (WindowEvent) - part of WindowStateListener
- **windowGainedFocus** (WindowEvent) - part of WindowFocusListener
- **windowLostFocus** (WindowEvent) - part of WindowFocusListener
- **windowActivated** (WindowEvent) - part of WindowListener
- **windowClosed** (WindowEvent) - part of WindowListener
- **windowClosing** (WindowEvent) - part of WindowListener
- **windowDeactivated** (WindowEvent) - part of WindowListener
- **windowDeiconified** (WindowEvent) - part of WindowListener
- **windowIconified** (WindowEvent) - part of WindowListener
- **windowOpened** (WindowEvent) - part of WindowListener

Declared in java.awt.Container

- **componentAdded** (ContainerEvent) - part of ContainerListener
- **componentRemoved** (ContainerEvent) - part of ContainerListener

Declared in java.awt.Component

- **keyPressed** (KeyEvent) - part of KeyListener
- **keyReleased** (KeyEvent) - part of KeyListener
- **keyTyped** (KeyEvent) - part of KeyListener
- **componentHidden** (ComponentEvent) - part of ComponentListener
- **componentMoved** (ComponentEvent) - part of ComponentListener
- **componentResized** (ComponentEvent) - part of ComponentListener
- **componentShown** (ComponentEvent) - part of ComponentListener
- **hierarchyChanged** (HierarchyEvent) - part of HierarchyListener
- **mouseClicked** (MouseEvent) - part of MouseListener
- **mouseEntered** (MouseEvent) - part of MouseListener
- **mouseExited** (MouseEvent) - part of MouseListener
- **mousePressed** (MouseEvent) - part of MouseListener
- **mouseReleased** (MouseEvent) - part of MouseListener
- **mouseDragged** (MouseEvent) - part of MouseMotionListener

- **mouseMoved** (MouseEvent) - part of MouseMotionListener
- **propertyChange** (PropertyChangeEvent) - part of PropertyChangeListener
- **ancestorMoved** (HierarchyEvent) - part of HierarchyBoundsListener
- **ancestorResized** (HierarchyEvent) - part of HierarchyBoundsListener
- **focusGained** (FocusEvent) - part of FocusListener
- **focusLost** (FocusEvent) - part of FocusListener
- **mouseWheelMoved** (MouseWheelEvent) - part of MouseWheelListener
- **caretPositionChanged** (InputMethodEvent) - part of InputMethodListener
- **inputMethodTextChanged** (InputMethodEvent) - part of InputMethodListener

Content

Usage

Examples

Observable Attributes

- accessibleContext
- active
- alignmentX
- alignmentY
- alwaysOnTop
- background
- bufferStrategy
- component
- componentCount
- components
- containerListeners
- cursor
- focusCycleRoot
- focusCycleRootAncestor
- focusOwner
- focusTraversalKeys
- focusTraversalPolicy
- focusTraversalPolicyProvider
- focusTraversalPolicySet
- focusable
- focusableWindow
- focusableWindowState
- focused
- font
- foreground
- graphicsConfiguration
- inputContext
- insets
- layout
- locale
- locationByPlatform
- locationRelativeTo
- maximumSize
- minimumSize
- modal
- mostRecentFocusOwner
- ownedWindows
- owner
- preferredSize
- resizable
- showing
- title
- toolkit
- undecorated

- warningString
- windowFocusListeners
- windowListeners
- windowStateListeners

SwingBuilder.editorPane

This page last changed on Mar 21, 2008 by [shemnon](#).

- [Generated Object](#)
- [Attributes](#)
- [Events](#)
- [Content](#)
- [Usage](#)
- [Examples](#)
- [Observable Attributes](#)

(Automatically generated from BeanInfo)

Generated Object

A `javax.swing.JEditorPane` is returned, unless the user passes in a subclass of `JEditorPane` as the value argument, in which case the value argument is returned.

Attributes

Declared in `javax.swing.JEditorPane`

- **contentType** <String> the type of content
- **editorKit** <EditorKit> the currently installed kit for handling content
- **page** <URL> the URL used to set content

Declared in `javax.swing.text.JTextComponent`

- **caret** <Caret> the caret used to select/navigate
- **caretColor** <Color> the color used to render the caret
- **caretPosition** <int> the caret position
- **disabledTextColor** <Color> color used to render disabled text
- **document** <Document> the text document model
- **dragEnabled** <boolean> determines whether automatic drag handling is enabled
- **editable** <boolean> specifies if the text can be edited
- **focusAccelerator** <char> accelerator character used to grab focus
- **highlighter** <Highlighter> object responsible for background highlights
- **keymap** <Keymap> set of key event to action bindings to use
- **margin** <Insets> desired space between the border and text area
- **selectedTextColor** <Color> color used to render selected text
- **selectionColor** <Color> color used to render selection background
- **selectionEnd** <int> ending location of the selection.
- **selectionStart** <int> starting location of the selection.
- **text** <String> the text of this component

- **UI** <TextUI>
- **inputMethodRequests** <InputMethodRequests>
- **navigationFilter** <NavigationFilter>
- **preferredScrollableViewportSize** <Dimension>
- **scrollableTracksViewportHeight** <boolean>
- **scrollableTracksViewportWidth** <boolean>
- **selectedText** <String>

Declared in `javax.swing.JComponent`

- **autoscrolls** <boolean> Determines if this component automatically scrolls its contents when dragged.
- **border** <Border> The component's border.
- **componentPopupMenu** <JPopupMenu> Popup to show
- **debugGraphicsOptions** <int> Diagnostic options for graphics operations.
- **inheritsPopupMenu** <boolean> Whether or not the `JPopupMenu` is inherited
- **inputVerifier** <InputVerifier> The component's input verifier.

- **opaque** <boolean> The component's opacity
- **toolTipText** <String> The text to display in a tool tip.
- **transferHandler** <TransferHandler> Mechanism for transfer of data to and from the component
- **verifyInputWhenFocusTarget** <boolean> Whether the Component verifies input before accepting focus.
- **UIClassID** <String>
- **accessibleContext** <AccessibleContext>
- **actionMap** <ActionMap>
- **doubleBuffered** <boolean>
- **graphics** <Graphics>
- **height** <int>
- **managingFocus** <boolean>
- **nextFocusableComponent** <Component>
- **optimizedDrawingEnabled** <boolean>
- **paintingTile** <boolean>
- **registeredKeyStrokes** <KeyStroke[]>
- **requestFocusEnabled** <boolean>
- **rootPane** <JRootPane>
- **topLevelAncestor** <Container>
- **validateRoot** <boolean>
- **visibleRect** <Rectangle>
- **width** <int>
- **x** <int>
- **y** <int>

Declared in `java.awt.Container`

- **alignmentX** <float>
- **alignmentY** <float>
- **componentCount** <int>
- **components** <Component[]>
- **focusCycleRoot** <boolean>
- **focusTraversalPolicy** <FocusTraversalPolicy>
- **focusTraversalPolicyProvider** <boolean>
- **focusTraversalPolicySet** <boolean>
- **insets** <Insets>
- **layout** <LayoutManager>
- **maximumSize** <Dimension>
- **minimumSize** <Dimension>
- **preferredSize** <Dimension>

Declared in `java.awt.Component`

- **background** <Color>
- **enabled** <boolean>
- **focusable** <boolean>
- **font**
- **foreground** <Color>
- **name** <String>
- **visible** <boolean>

Events

Declared in `javax.swing.JEditorPane`

- **hyperlinkUpdate** (HyperlinkEvent) - part of HyperlinkListener

Declared in `javax.swing.text.JTextComponent`

- **caretUpdate** (CaretEvent) - part of CaretListener

Declared in javax.swing.JComponent

- **vetoableChange** (PropertyChangeEvent) - part of VetoableChangeListener
- **ancestorMoved** (AncestorEvent) - part of AncestorListener
- **ancestorAdded** (AncestorEvent) - part of AncestorListener
- **ancestorRemoved** (AncestorEvent) - part of AncestorListener

Declared in java.awt.Container

- **componentAdded** (ContainerEvent) - part of ContainerListener
- **componentRemoved** (ContainerEvent) - part of ContainerListener

Declared in java.awt.Component

- **keyPressed** (KeyEvent) - part of KeyListener
- **keyReleased** (KeyEvent) - part of KeyListener
- **keyTyped** (KeyEvent) - part of KeyListener
- **componentHidden** (ComponentEvent) - part of ComponentListener
- **componentMoved** (ComponentEvent) - part of ComponentListener
- **componentResized** (ComponentEvent) - part of ComponentListener
- **componentShown** (ComponentEvent) - part of ComponentListener
- **hierarchyChanged** (HierarchyEvent) - part of HierarchyListener
- **mouseClicked** (MouseEvent) - part of MouseListener
- **mouseEntered** (MouseEvent) - part of MouseListener
- **mouseExited** (MouseEvent) - part of MouseListener
- **mousePressed** (MouseEvent) - part of MouseListener
- **mouseReleased** (MouseEvent) - part of MouseListener
- **mouseDragged** (MouseEvent) - part of MouseMotionListener
- **mouseMoved** (MouseEvent) - part of MouseMotionListener
- **propertyChange** (PropertyChangeEvent) - part of PropertyChangeListener
- **ancestorMoved** (HierarchyEvent) - part of HierarchyBoundsListener
- **ancestorResized** (HierarchyEvent) - part of HierarchyBoundsListener
- **focusGained** (FocusEvent) - part of FocusListener
- **focusLost** (FocusEvent) - part of FocusListener
- **mouseWheelMoved** (MouseEvent) - part of MouseWheelListener
- **caretPositionChanged** (InputMethodEvent) - part of InputMethodListener
- **inputMethodTextChanged** (InputMethodEvent) - part of InputMethodListener

Content

Usage

Examples

Observable Attributes

- alignmentX
- alignmentY
- background
- border
- caret
- caretColor
- component
- componentCount
- componentPopupMenu
- components
- containerListeners
- disabledTextColor
- document
- editable
- editorKit

- enabled
- focusAccelerator
- focusCycleRoot
- focusTraversalKeys
- focusTraversalPolicy
- focusTraversalPolicyProvider
- focusTraversalPolicySet
- focusable
- font
- foreground
- highlighter
- inheritsPopupMenu
- inputVerifier
- insets
- keymap
- layout
- margin
- maximumSize
- minimumSize
- opaque
- page
- preferredSize
- selectedTextColor
- selectionColor
- transferHandler
- verifyInputWhenFocusTarget

SwingBuilder.emptyBorder

This page last changed on Feb 18, 2008 by [fjanon](#).

Generated Object

A `javax.swing.border.EmptyBorder`, a border whose margins are not painted with anything.

Value Argument

Either an Integer or an array of four Integers.

A single integer is expanded to an array of four integers of the same value.

An array of four integers is used to generate the top, left, bottom, and right margins, respectively.

If a value argument is used then the `top:`, `left:`, `bottom:`, and `right:` attributes cannot be used.

Attributes

If any of `top:`, `left:`, `bottom:`, or `right:` are specified the all of them must be specified.

- **top** <int> the top margin of the border
- **left** <int> the left margin of the border
- **bottom** <int> the bottom margin of the border
- **right** <int> the right margin of the border
- **parent** <boolean> Whether or not this border is to be added to the parent JComponent

Content

`emptyBorder()` is a leaf node, no child content is allowed.

Examples

```
panel(border:emptyBorder(3))
```

```
panel {
emptyBorder([6,6,3,3], parent:true)
}
```

```
emptyBorder(top:5, left:15, bottom:15, right:5)
```

Note:

Do work:

```
border: BorderFactory.createEmptyBorder(0,3,0,3)
border: emptyBorder([0,3,0,3])
border: emptyBorder(top:0,left:3,bottom:0,right:3)
```

Does not work:

```
border: emptyBorder(0,3,0,3)
border: emptyBorder(top:3)
```

SwingBuilder.etchedBorder

This page last changed on Oct 23, 2007 by [shemnon](#).

Generated Object

A `javax.swing.border.EtchedBorder`, a border that looks like a groove has been etched into the panel.

Value Argument

`etchedBorder()` takes no value arguments.

Attributes

If any of `shadow:` or `highlight:` are specified, all must be specified.

- **highlight** <Color> The color that is to be painted on the highlight side of the etch.
- **shadow** <Color> The color that is to be painted on the shadow side of the etch.
- **parent** <boolean> Whether or not this border is to be added to the parent `JComponent`.

Content

`etchedBorder()` is a leaf node, no child content is allowed.

Examples

```
panel(border:etchedBorder())
```

```
panel {
  etchedBorder(shadow:Color.RED, highlight:Color.PINK, parent:true)
}
```

SwingBuilder.fileChooser

This page last changed on Mar 21, 2008 by [shemnon](#).

- [Generated Object](#)
- [Attributes](#)
- [Events](#)
- [Content](#)
- [Usage](#)
- [Examples](#)
- [Observable Attributes](#)

(Automatically generated from BeanInfo)

Generated Object

A `javax.swing.JFileChooser` is returned, unless the user passes in a subclass of `JFileChooser` as the value argument, in which case the value argument is returned.

Attributes

Declared in `javax.swing.JFileChooser`

- **acceptAllFileFilterUsed** <boolean> Sets whether the AcceptAll FileFilter is used as an available choice in the choosable filter list.
- **accessory** <JComponent> Sets the accessory component on the JFileChooser.
- **approveButtonMnemonic** <int> The mnemonic key accelerator for the ApproveButton.
- **approveButtonText** <String> The text that goes in the ApproveButton.
- **approveButtonToolTipText** <String> The tooltip text for the ApproveButton.
- **controlButtonsAreShown** <boolean> Sets whether the approve & cancel buttons are shown.
- **currentDirectory** <File> The directory that the JFileChooser is showing files of.
- **dialogTitle** <String> The title of the JFileChooser dialog window.
- **dialogType** <int> The type (open, save, custom) of the JFileChooser.
- **dragEnabled** <boolean> determines whether automatic drag handling is enabled
- **fileFilter** <FileFilter> Sets the File Filter used to filter out files of type.
- **fileHidingEnabled** <boolean> Sets file hiding on or off.
- **fileSelectionMode** <int> Sets the types of files that the JFileChooser can choose.
- **fileSystemView** <FileSystemView> Sets the FileSystemView used to get filesystem information.
- **fileView** <FileView> Sets the File View used to get file type information.
- **multiSelectionEnabled** <boolean> Sets multiple file selection mode.
- **selectedFiles** <File[]> The list of selected files if the chooser is in multiple selection mode.

- **UI** <FileChooserUI>
- **acceptAllFileFilter** <FileFilter>
- **choosableFileFilters** <FileFilter[]>
- **directorySelectionEnabled** <boolean>
- **fileSelectionEnabled** <boolean>
- **selectedFile** <File>

Declared in `javax.swing.JComponent`

- **autoscrolls** <boolean> Determines if this component automatically scrolls its contents when dragged.
- **border** <Border> The component's border.
- **componentPopupMenu** <JPopupMenu> Popup to show
- **debugGraphicsOptions** <int> Diagnostic options for graphics operations.
- **inheritsPopupMenu** <boolean> Whether or not the JPopupMenu is inherited
- **inputVerifier** <InputVerifier> The component's input verifier.
- **opaque** <boolean> The component's opacity
- **toolTipText** <String> The text to display in a tool tip.
- **transferHandler** <TransferHandler> Mechanism for transfer of data to and from the component
- **verifyInputWhenFocusTarget** <boolean> Whether the Component verifies input before accepting focus.

- **UIClassID** <String>
- **accessibleContext** <AccessibleContext>
- **actionMap** <ActionMap>
- **doubleBuffered** <boolean>
- **graphics** <Graphics>
- **height** <int>
- **managingFocus** <boolean>
- **nextFocusableComponent** <Component>
- **optimizedDrawingEnabled** <boolean>
- **paintingTile** <boolean>
- **registeredKeyStrokes** <KeyStroke[]>
- **requestFocusEnabled** <boolean>
- **rootPane** <JRootPane>
- **topLevelAncestor** <Container>
- **validateRoot** <boolean>
- **visibleRect** <Rectangle>
- **width** <int>
- **x** <int>
- **y** <int>

Declared in java.awt.Container

- **alignmentX** <float>
- **alignmentY** <float>
- **componentCount** <int>
- **components** <Component[]>
- **focusCycleRoot** <boolean>
- **focusTraversalPolicy** <FocusTraversalPolicy>
- **focusTraversalPolicyProvider** <boolean>
- **focusTraversalPolicySet** <boolean>
- **insets** <Insets>
- **layout** <LayoutManager>
- **maximumSize** <Dimension>
- **minimumSize** <Dimension>
- **preferredSize** <Dimension>

Declared in java.awt.Component

- **background** <Color>
- **enabled** <boolean>
- **focusable** <boolean>
- **font**
- **foreground** <Color>
- **name** <String>
- **visible** <boolean>

Events

Declared in javax.swing.JFileChooser

- **actionPerformed** (ActionEvent) - part of ActionListener

Declared in javax.swing.JComponent

- **vetoableChange** (PropertyChangeEvent) - part of VetoableChangeListener
- **ancestorMoved** (AncestorEvent) - part of AncestorListener
- **ancestorAdded** (AncestorEvent) - part of AncestorListener
- **ancestorRemoved** (AncestorEvent) - part of AncestorListener

Declared in java.awt.Container

- **componentAdded** (ContainerEvent) - part of ContainerListener

- **componentRemoved** (ContainerEvent) - part of ContainerListener

Declared in java.awt.Component

- **keyPressed** (KeyEvent) - part of KeyListener
- **keyReleased** (KeyEvent) - part of KeyListener
- **keyTyped** (KeyEvent) - part of KeyListener
- **componentHidden** (ComponentEvent) - part of ComponentListener
- **componentMoved** (ComponentEvent) - part of ComponentListener
- **componentResized** (ComponentEvent) - part of ComponentListener
- **componentShown** (ComponentEvent) - part of ComponentListener
- **hierarchyChanged** (HierarchyEvent) - part of HierarchyListener
- **mouseClicked** (MouseEvent) - part of MouseListener
- **mouseEntered** (MouseEvent) - part of MouseListener
- **mouseExited** (MouseEvent) - part of MouseListener
- **mousePressed** (MouseEvent) - part of MouseListener
- **mouseReleased** (MouseEvent) - part of MouseListener
- **mouseDragged** (MouseEvent) - part of MouseMotionListener
- **mouseMoved** (MouseEvent) - part of MouseMotionListener
- **propertyChange** (PropertyChangeEvent) - part of PropertyChangeListener
- **ancestorMoved** (HierarchyEvent) - part of HierarchyBoundsListener
- **ancestorResized** (HierarchyEvent) - part of HierarchyBoundsListener
- **focusGained** (FocusEvent) - part of FocusListener
- **focusLost** (FocusEvent) - part of FocusListener
- **mouseWheelMoved** (MouseEvent) - part of MouseWheelListener
- **caretPositionChanged** (InputMethodEvent) - part of InputMethodListener
- **inputMethodTextChanged** (InputMethodEvent) - part of InputMethodListener

Content

Usage

Examples

Observable Attributes

- acceptAllFileFilterUsed
- accessory
- alignmentX
- alignmentY
- approveButtonMnemonic
- approveButtonText
- approveButtonToolTipText
- background
- border
- component
- componentCount
- componentPopupMenu
- components
- containerListeners
- controlButtonsAreShown
- currentDirectory
- dialogTitle
- dialogType
- enabled
- fileFilter
- fileHidingEnabled
- fileSelectionMode
- fileSystemView
- fileView
- focusCycleRoot
- focusTraversalKeys

- focusTraversalPolicy
- focusTraversalPolicyProvider
- focusTraversalPolicySet
- focusable
- font
- foreground
- inheritsPopupMenu
- inputVerifier
- insets
- layout
- maximumSize
- minimumSize
- multiSelectionEnabled
- opaque
- preferredSize
- selectedFile
- selectedFiles
- transferHandler
- verifyInputWhenFocusTarget

SwingBuilder.flowLayout

This page last changed on Mar 21, 2008 by [shemnon](#).

- [Generated Object](#)
- [Attributes](#)
- [Events](#)
- [Content](#)
- [Usage](#)
- [Examples](#)

(Automatically generated from BeanInfo)

Generated Object

A `java.awt.FlowLayout` is returned, unless the user passes in a subclass of `FlowLayout` as the value argument, in which case the value argument is returned.

Attributes

Declared in `java.awt.FlowLayout`

- **alignment** <int>
- **hgap** <int>
- **vgap** <int>

Events

Content

Usage

Examples

SwingBuilder.formattedTextField

This page last changed on Mar 20, 2008 by [shemnon](#).

- [Generated Object](#)
- [Attributes](#)
- [Events](#)
- [Content](#)
- [Usage](#)
- [Examples](#)
- [Observable Attributes](#)

(Automatically generated from BeanInfo)

Generated Object

A `javax.swing.JFormattedTextField` is returned, unless the user passes in a subclass of `JFormattedTextField` as the value argument, in which case the value argument is returned.

Attributes

Declared in `javax.swing.JFormattedTextField`

- **focusLostBehavior** <int> Behavior when component loses focus
- **formatter** <AbstractFormatter> `TextFormatter`, responsible for formatting the current value
- **formatterFactory** <AbstractFormatterFactory> `AbstractFormatterFactory`, responsible for returning an `AbstractFormatter` that can format the current value.
- **value** <Object> The value to be formatted.

- **editValid** <boolean>

Declared in `javax.swing.JTextField`

- **action** <Action> the Action instance connected with this ActionEvent source
- **columns** <int> the number of columns preferred for display
- **horizontalAlignment** <int> Set the field alignment to LEFT, CENTER, RIGHT, LEADING (the default) or TRAILING

- **horizontalVisibility** <BoundedRangeModel>
- **scrollOffset** <int>

Declared in `javax.swing.text.JTextComponent`

- **caret** <Caret> the caret used to select/navigate
- **caretColor** <Color> the color used to render the caret
- **caretPosition** <int> the caret position
- **disabledTextColor** <Color> color used to render disabled text
- **document** <Document> the text document model
- **dragEnabled** <boolean> determines whether automatic drag handling is enabled
- **editable** <boolean> specifies if the text can be edited
- **focusAccelerator** <char> accelerator character used to grab focus
- **highlighter** <Highlighter> object responsible for background highlights
- **keymap** <Keymap> set of key event to action bindings to use
- **margin** <Insets> desired space between the border and text area
- **selectedTextColor** <Color> color used to render selected text
- **selectionColor** <Color> color used to render selection background
- **selectionEnd** <int> ending location of the selection.
- **selectionStart** <int> starting location of the selection.
- **text** <String> the text of this component

- **UI** <TextUI>
- **inputMethodRequests** <InputMethodRequests>
- **navigationFilter** <NavigationFilter>

- **preferredScrollableViewportSize** <Dimension>
- **scrollableTracksViewportHeight** <boolean>
- **scrollableTracksViewportWidth** <boolean>
- **selectedText** <String>

Declared in javax.swing.JComponent

- **autoscrolls** <boolean> Determines if this component automatically scrolls its contents when dragged.
- **border** <Border> The component's border.
- **componentPopupMenu** <JPopupMenu> Popup to show
- **debugGraphicsOptions** <int> Diagnostic options for graphics operations.
- **inheritsPopupMenu** <boolean> Whether or not the JPopupMenu is inherited
- **inputVerifier** <InputVerifier> The component's input verifier.
- **opaque** <boolean> The component's opacity
- **toolTipText** <String> The text to display in a tool tip.
- **transferHandler** <TransferHandler> Mechanism for transfer of data to and from the component
- **verifyInputWhenFocusTarget** <boolean> Whether the Component verifies input before accepting focus.
- **UIClassID** <String>
- **accessibleContext** <AccessibleContext>
- **actionMap** <ActionMap>
- **doubleBuffered** <boolean>
- **graphics** <Graphics>
- **height** <int>
- **managingFocus** <boolean>
- **nextFocusableComponent** <Component>
- **optimizedDrawingEnabled** <boolean>
- **paintingTile** <boolean>
- **registeredKeyStrokes** <KeyStroke[]>
- **requestFocusEnabled** <boolean>
- **rootPane** <JRootPane>
- **topLevelAncestor** <Container>
- **validateRoot** <boolean>
- **visibleRect** <Rectangle>
- **width** <int>
- **x** <int>
- **y** <int>

Declared in java.awt.Container

- **alignmentX** <float>
- **alignmentY** <float>
- **componentCount** <int>
- **components** <Component[]>
- **focusCycleRoot** <boolean>
- **focusTraversalPolicy** <FocusTraversalPolicy>
- **focusTraversalPolicyProvider** <boolean>
- **focusTraversalPolicySet** <boolean>
- **insets** <Insets>
- **layout** <LayoutManager>
- **maximumSize** <Dimension>
- **minimumSize** <Dimension>
- **preferredSize** <Dimension>

Declared in java.awt.Component

- **background** <Color>
- **enabled** <boolean>
- **focusable** <boolean>
- **font**
- **foreground** <Color>

- **name** <String>
- **visible** <boolean>

Events

Declared in `javax.swing.JTextField`

- **actionPerformed** (ActionEvent) - part of ActionListener

Declared in `javax.swing.text.JTextComponent`

- **caretUpdate** (CaretEvent) - part of CaretListener

Declared in `javax.swing.JComponent`

- **vetoableChange** (PropertyChangeEvent) - part of VetoableChangeListener
- **ancestorMoved** (AncestorEvent) - part of AncestorListener
- **ancestorAdded** (AncestorEvent) - part of AncestorListener
- **ancestorRemoved** (AncestorEvent) - part of AncestorListener

Declared in `java.awt.Container`

- **componentAdded** (ContainerEvent) - part of ContainerListener
- **componentRemoved** (ContainerEvent) - part of ContainerListener

Declared in `java.awt.Component`

- **keyPressed** (KeyEvent) - part of KeyListener
- **keyReleased** (KeyEvent) - part of KeyListener
- **keyTyped** (KeyEvent) - part of KeyListener
- **componentHidden** (ComponentEvent) - part of ComponentListener
- **componentMoved** (ComponentEvent) - part of ComponentListener
- **componentResized** (ComponentEvent) - part of ComponentListener
- **componentShown** (ComponentEvent) - part of ComponentListener
- **hierarchyChanged** (HierarchyEvent) - part of HierarchyListener
- **mouseClicked** (MouseEvent) - part of MouseListener
- **mouseEntered** (MouseEvent) - part of MouseListener
- **mouseExited** (MouseEvent) - part of MouseListener
- **mousePressed** (MouseEvent) - part of MouseListener
- **mouseReleased** (MouseEvent) - part of MouseListener
- **mouseDragged** (MouseEvent) - part of MouseMotionListener
- **mouseMoved** (MouseEvent) - part of MouseMotionListener
- **propertyChange** (PropertyChangeEvent) - part of PropertyChangeListener
- **ancestorMoved** (HierarchyEvent) - part of HierarchyBoundsListener
- **ancestorResized** (HierarchyEvent) - part of HierarchyBoundsListener
- **focusGained** (FocusEvent) - part of FocusListener
- **focusLost** (FocusEvent) - part of FocusListener
- **mouseWheelMoved** (MouseWheelEvent) - part of MouseWheelListener
- **caretPositionChanged** (InputMethodEvent) - part of InputMethodListener
- **inputMethodTextChanged** (InputMethodEvent) - part of InputMethodListener

Content

Usage

Examples

Observable Attributes

- action

- alignmentX
- alignmentY
- background
- border
- caret
- caretColor
- component
- componentCount
- componentPopupMenu
- components
- containerListeners
- disabledTextColor
- document
- editable
- enabled
- focusAccelerator
- focusCycleRoot
- focusTraversalKeys
- focusTraversalPolicy
- focusTraversalPolicyProvider
- focusTraversalPolicySet
- focusable
- font
- foreground
- formatter
- formatterFactory
- highlighter
- horizontalAlignment
- inheritsPopupMenu
- inputVerifier
- insets
- keymap
- layout
- margin
- maximumSize
- minimumSize
- opaque
- preferredSize
- selectedTextColor
- selectionColor
- transferHandler
- value
- verifyInputWhenFocusTarget

SwingBuilder.frame

This page last changed on Mar 21, 2008 by [shemnon](#).

- [Generated Object](#)
- [Attributes](#)
- [Events](#)
- [Content](#)
- [Usage](#)
- [Examples](#)
- [Observable Attributes](#)

(Automatically generated from BeanInfo)

Generated Object

A `javax.swing.JFrame` is returned, unless the user passes in a subclass of `JFrame` as the value argument, in which case the value argument is returned.

Attributes

Declared in `javax.swing.JFrame`

- **JMenuBar** <JMenuBar> The menubar for accessing pulldown menus from this frame.
- **contentPane** <Container> The client area of the frame where child components are normally inserted.
- **defaultCloseOperation** <int> The frame's default close operation.
- **glassPane** <Component> A transparent pane used for menu rendering.
- **layeredPane** <JLayeredPane> The pane that holds the various frame layers.
- **rootPane** <JRootPane> the `RootPane` object for this frame.

Declared in `java.awt.Frame`

- **cursorType** <int>
- **extendedState** <int>
- **iconImage** <Image>
- **maximizedBounds** <Rectangle>
- **menuBar** <MenuBar>
- **resizable** <boolean>
- **state** <int>
- **title** <String>
- **undecorated** <boolean>

Declared in `java.awt.Window`

- **accessibleContext** <AccessibleContext>
- **active** <boolean>
- **alwaysOnTop** <boolean>
- **bufferStrategy** <BufferStrategy>
- **cursor** <Cursor>
- **focusCycleRootAncestor** <Container>
- **focusOwner** <Component>
- **focusableWindow** <boolean>
- **focusableWindowState** <boolean>
- **focused** <boolean>
- **graphicsConfiguration** <GraphicsConfiguration>
- **inputContext** <InputContext>
- **locale** <Locale>
- **locationByPlatform** <boolean>
- **locationRelativeTo** <Component>
- **mostRecentFocusOwner** <Component>
- **ownedWindows** <Window[]>
- **owner** <Window>

- **showing** <boolean>
- **toolkit** <Toolkit>
- **warningString** <String>

Declared in java.awt.Container

- **alignmentX** <float>
- **alignmentY** <float>
- **componentCount** <int>
- **components** <Component[]>
- **focusCycleRoot** <boolean>
- **focusTraversalPolicy** <FocusTraversalPolicy>
- **focusTraversalPolicyProvider** <boolean>
- **focusTraversalPolicySet** <boolean>
- **insets** <Insets>
- **layout** <LayoutManager>
- **maximumSize** <Dimension>
- **minimumSize** <Dimension>
- **preferredSize** <Dimension>

Declared in java.awt.Component

- **background** <Color>
- **enabled** <boolean>
- **focusable** <boolean>
- **font**
- **foreground** <Color>
- **name** <String>
- **visible** <boolean>

Events

Declared in java.awt.Window

- **windowStateChanged** (WindowEvent) - part of WindowStateListener
- **windowGainedFocus** (WindowEvent) - part of WindowFocusListener
- **windowLostFocus** (WindowEvent) - part of WindowFocusListener
- **windowActivated** (WindowEvent) - part of WindowListener
- **windowClosed** (WindowEvent) - part of WindowListener
- **windowClosing** (WindowEvent) - part of WindowListener
- **windowDeactivated** (WindowEvent) - part of WindowListener
- **windowDeiconified** (WindowEvent) - part of WindowListener
- **windowIconified** (WindowEvent) - part of WindowListener
- **windowOpened** (WindowEvent) - part of WindowListener

Declared in java.awt.Container

- **componentAdded** (ContainerEvent) - part of ContainerListener
- **componentRemoved** (ContainerEvent) - part of ContainerListener

Declared in java.awt.Component

- **keyPressed** (KeyEvent) - part of KeyListener
- **keyReleased** (KeyEvent) - part of KeyListener
- **keyTyped** (KeyEvent) - part of KeyListener
- **componentHidden** (ComponentEvent) - part of ComponentListener
- **componentMoved** (ComponentEvent) - part of ComponentListener
- **componentResized** (ComponentEvent) - part of ComponentListener
- **componentShown** (ComponentEvent) - part of ComponentListener
- **hierarchyChanged** (HierarchyEvent) - part of HierarchyListener
- **mouseClicked** (MouseEvent) - part of MouseListener
- **mouseEntered** (MouseEvent) - part of MouseListener

- **mouseExited** (MouseEvent) - part of MouseListener
- **mousePressed** (MouseEvent) - part of MouseListener
- **mouseReleased** (MouseEvent) - part of MouseListener
- **mouseDragged** (MouseEvent) - part of MouseMotionListener
- **mouseMoved** (MouseEvent) - part of MouseMotionListener
- **propertyChange** (PropertyChangeEvent) - part of PropertyChangeListener
- **ancestorMoved** (HierarchyEvent) - part of HierarchyBoundsListener
- **ancestorResized** (HierarchyEvent) - part of HierarchyBoundsListener
- **focusGained** (FocusEvent) - part of FocusListener
- **focusLost** (FocusEvent) - part of FocusListener
- **mouseWheelMoved** (MouseWheelEvent) - part of MouseWheelListener
- **caretPositionChanged** (InputMethodEvent) - part of InputMethodListener
- **inputMethodTextChanged** (InputMethodEvent) - part of InputMethodListener

Content

Usage

Examples

Observable Attributes

- accessibleContext
- active
- alignmentX
- alignmentY
- alwaysOnTop
- background
- bufferStrategy
- component
- componentCount
- components
- containerListeners
- cursor
- cursorType
- defaultCloseOperation
- extendedState
- focusCycleRoot
- focusCycleRootAncestor
- focusOwner
- focusTraversalKeys
- focusTraversalPolicy
- focusTraversalPolicyProvider
- focusTraversalPolicySet
- focusable
- focusableWindow
- focusableWindowState
- focused
- font
- foreground
- graphicsConfiguration
- iconImage
- inputContext
- insets
- layout
- locale
- locationByPlatform
- locationRelativeTo
- maximizedBounds
- maximumSize
- menuBar
- minimumSize

- mostRecentFocusOwner
- ownedWindows
- owner
- preferredSize
- resizable
- showing
- state
- title
- toolkit
- undecorated
- warningString
- windowFocusListeners
- windowListeners
- windowStateListeners

SwingBuilder.gridBagConstraints

This page last changed on Mar 21, 2008 by [shemnon](#).

- [Generated Object](#)
- [Attributes](#)
- [Events](#)
- [Content](#)
- [Usage](#)
- [Examples](#)

(Automatically generated from BeanInfo)

Generated Object

A java.awt.GridBagConstraints is returned, unless the user passes in a subclass of GridBagConstraints as the value argument, in which case the value argument is returned.

Attributes

Events

Content

Usage

Examples

SwingBuilder.gridBagLayout

This page last changed on Mar 26, 2008 by justin@jhickman.com.

- [Generated Object](#)
- [Attributes](#)
- [Events](#)
- [Content](#)
- [Usage](#)
- [Examples](#)

(Automatically generated from BeanInfo)

Generated Object

A `java.awt.GridBagLayout` is returned, unless the user passes in a subclass of `GridBagLayout` as the value argument, in which case the value argument is returned.

Attributes

Declared in `java.awt.GridBagLayout`

- **layoutDimensions** <`int[][]`>
- **layoutOrigin** <`Point`>
- **layoutWeights** <`double[][]`>

Events

Content

Usage

Examples

```
swing.panel() {
gridBagLayout()

label(text:"Hello", constraints:gbc(gridx:0,gridy:0,gridwidth:GridBagConstraints.REMAINDER,
fill:GridBagConstraints.HORIZONTAL, insets:[10,10,10,10]))

button(text:"Click me" constraints:gbc(gridx:0,gridy:1))
}
```

SwingBuilder.gridLayout

This page last changed on Mar 21, 2008 by [shemnon](#).

- [Generated Object](#)
- [Attributes](#)
- [Events](#)
- [Content](#)
- [Usage](#)
- [Examples](#)

(Automatically generated from BeanInfo)

Generated Object

A java.awt.GridLayout is returned, unless the user passes in a subclass of GridLayout as the value argument, in which case the value argument is returned.

Attributes

Declared in java.awt.GridLayout

- **columns** <int>
- **hgap** <int>
- **rows** <int>
- **vgap** <int>

Events

Content

Usage

Examples

SwingBuilder.imageIcon

This page last changed on Oct 23, 2007 by [shemnon](#).

Generated Object

A `javax.swing.ImageIcon`, where the supplied image details are loaded into the icon.

Value Argument

The value argument can be a `String`, `URL`, `java.awt.Image`, or `byte[]`. There is no attribute equivalent to the `byte[]` value argument.

If the value argument is a `String` it can be treated in multiple ways. If the value resolved to a `File` resolved without any context, then the value argument is treated as though it was passed in as a `file:` attribute. If the file does not exist, it is treated as though it were passed in as a `resource:` attribute.

Attributes

the value argument, `file :`, `url:`, `image:`, and `resource:` are mutually exclusive.

- **file** `<String>` The name of a file where the `ImageIcon` can be loaded from
- **image** `<java.awt.Image>` The image to be used for the icon
- **resource** `<String>` The name of a resource to be resolved against the class loader
 - **class** `<Object or Class>` The class (or instance of a `Class`) that the resource is to be resolved against. Relative resources will be resolved relative to the package of the `Class` in the `ClassLoader`. If this attribute is not passed in then the `ClassLoader` of the `SwingBuilder ImageIconFactory` will be used to resolve the resource
- **url** `<URL>` A `URL` to an image to load

//TODO we should accept strings to `file:` and `url:`, in the future.

Content

`imageIcon()` is a leaf node, no child content is allowed.

Examples

```
label(icon:imageIcon('http://docs.codehaus.org/download/userResources/GROOVY/logo'))
```

```
button(icon:imageIcon(url:'http://www.google.com/favicon.ico'))
```

```
imageIcon('ConsoleIcon.png', class:groovy.ui.Console)
```

```
imageIcon(resource:'/groovy/ui/ConsoleIcon.png')
```

SwingBuilder.internalFrame

This page last changed on Mar 21, 2008 by [shemnon](#).

- [Generated Object](#)
- [Attributes](#)
- [Events](#)
- [Content](#)
- [Usage](#)
- [Examples](#)
- [Observable Attributes](#)
- [Vetoable Attributes](#)

(Automatically generated from BeanInfo)

Generated Object

A `javax.swing.JInternalFrame` is returned, unless the user passes in a subclass of `JInternalFrame` as the value argument, in which case the value argument is returned.

Attributes

Declared in `javax.swing.JInternalFrame`

- **JMenuBar** <JMenuBar> The menu bar for accessing pulldown menus from this internal frame.
- **UI** <InternalFrameUI> The UI object that implements the Component's LookAndFeel.
- **closed** <boolean> Indicates whether this internal frame can be closed.
- **closed** <boolean> Indicates whether this internal frame has been closed.
- **contentPane** <Container> The client area of the internal frame where child components are normally inserted.
- **desktopIcon** <JDesktopIcon> The icon shown when this internal frame is minimized.
- **frameIcon** <Icon> The icon shown in the top-left corner of this internal frame.
- **glassPane** <Component> A transparent pane used for menu rendering.
- **icon** <boolean> The image displayed when this internal frame is minimized.
- **iconifiable** <boolean> Determines whether this internal frame can be iconified.
- **layer** <int> Specifies what desktop layer is used.
- **layeredPane** <JLayeredPane> The pane which holds the various desktop layers.
- **maximizable** <boolean> Determines whether this internal frame can be maximized.
- **maximum** <boolean> Indicates whether this internal frame is maximized.
- **resizable** <boolean> Determines whether this internal frame can be resized by the user.
- **selected** <boolean> Indicates whether this internal frame is currently the active frame.
- **title** <String> The text displayed in the title bar.

- **defaultCloseOperation** <int>
- **desktopPane** <JDesktopPane>
- **focusCycleRootAncestor** <Container>
- **focusOwner** <boolean>
- **menuBar** <JMenuBar>
- **mostRecentFocusOwner** <Component>
- **normalBounds** <Rectangle>
- **warningString** <String>

Declared in `javax.swing.JComponent`

- **autoscrolls** <boolean> Determines if this component automatically scrolls its contents when dragged.
- **border** <Border> The component's border.
- **componentPopupMenu** <JPopupMenu> Popup to show
- **debugGraphicsOptions** <int> Diagnostic options for graphics operations.
- **inheritsPopupMenu** <boolean> Whether or not the JPopupMenu is inherited
- **inputVerifier** <InputVerifier> The component's input verifier.
- **opaque** <boolean> The component's opacity
- **toolTipText** <String> The text to display in a tool tip.

- **transferHandler** <TransferHandler> Mechanism for transfer of data to and from the component
- **verifyInputWhenFocusTarget** <boolean> Whether the Component verifies input before accepting focus.
- **UIClassID** <String>
- **accessibleContext** <AccessibleContext>
- **actionMap** <ActionMap>
- **doubleBuffered** <boolean>
- **graphics** <Graphics>
- **height** <int>
- **managingFocus** <boolean>
- **nextFocusableComponent** <Component>
- **optimizedDrawingEnabled** <boolean>
- **paintingTile** <boolean>
- **registeredKeyStrokes** <KeyStroke[]>
- **requestFocusEnabled** <boolean>
- **rootPane** <JRootPane>
- **topLevelAncestor** <Container>
- **validateRoot** <boolean>
- **visibleRect** <Rectangle>
- **width** <int>
- **x** <int>
- **y** <int>

Declared in java.awt.Container

- **alignmentX** <float>
- **alignmentY** <float>
- **componentCount** <int>
- **components** <Component[]>
- **focusCycleRoot** <boolean>
- **focusTraversalPolicy** <FocusTraversalPolicy>
- **focusTraversalPolicyProvider** <boolean>
- **focusTraversalPolicySet** <boolean>
- **insets** <Insets>
- **layout** <LayoutManager>
- **maximumSize** <Dimension>
- **minimumSize** <Dimension>
- **preferredSize** <Dimension>

Declared in java.awt.Component

- **background** <Color>
- **enabled** <boolean>
- **focusable** <boolean>
- **font**
- **foreground** <Color>
- **name** <String>
- **visible** <boolean>

Events

Declared in javax.swing.JInternalFrame

- **internalFrameActivated** (InternalFrameEvent) - part of InternalFrameListener
- **internalFrameClosed** (InternalFrameEvent) - part of InternalFrameListener
- **internalFrameClosing** (InternalFrameEvent) - part of InternalFrameListener
- **internalFrameDeactivated** (InternalFrameEvent) - part of InternalFrameListener
- **internalFrameDeiconified** (InternalFrameEvent) - part of InternalFrameListener
- **internalFrameIconified** (InternalFrameEvent) - part of InternalFrameListener
- **internalFrameOpened** (InternalFrameEvent) - part of InternalFrameListener

Declared in javax.swing.JComponent

- **vetoableChange** (PropertyChangeEvent) - part of VetoableChangeListener
- **ancestorMoved** (AncestorEvent) - part of AncestorListener
- **ancestorAdded** (AncestorEvent) - part of AncestorListener
- **ancestorRemoved** (AncestorEvent) - part of AncestorListener

Declared in java.awt.Container

- **componentAdded** (ContainerEvent) - part of ContainerListener
- **componentRemoved** (ContainerEvent) - part of ContainerListener

Declared in java.awt.Component

- **keyPressed** (KeyEvent) - part of KeyListener
- **keyReleased** (KeyEvent) - part of KeyListener
- **keyTyped** (KeyEvent) - part of KeyListener
- **componentHidden** (ComponentEvent) - part of ComponentListener
- **componentMoved** (ComponentEvent) - part of ComponentListener
- **componentResized** (ComponentEvent) - part of ComponentListener
- **componentShown** (ComponentEvent) - part of ComponentListener
- **hierarchyChanged** (HierarchyEvent) - part of HierarchyListener
- **mouseClicked** (MouseEvent) - part of MouseListener
- **mouseEntered** (MouseEvent) - part of MouseListener
- **mouseExited** (MouseEvent) - part of MouseListener
- **mousePressed** (MouseEvent) - part of MouseListener
- **mouseReleased** (MouseEvent) - part of MouseListener
- **mouseDragged** (MouseEvent) - part of MouseMotionListener
- **mouseMoved** (MouseEvent) - part of MouseMotionListener
- **propertyChange** (PropertyChangeEvent) - part of PropertyChangeListener
- **ancestorMoved** (HierarchyEvent) - part of HierarchyBoundsListener
- **ancestorResized** (HierarchyEvent) - part of HierarchyBoundsListener
- **focusGained** (FocusEvent) - part of FocusListener
- **focusLost** (FocusEvent) - part of FocusListener
- **mouseWheelMoved** (MouseEvent) - part of MouseWheelListener
- **caretPositionChanged** (InputMethodEvent) - part of InputMethodListener
- **inputMethodTextChanged** (InputMethodEvent) - part of InputMethodListener

Content

Usage

Examples

Observable Attributes

- JMenuBar
- UI
- alignmentX
- alignmentY
- background
- border
- closable
- closed
- component
- componentCount
- componentPopupMenu
- components
- containerListeners
- contentPane
- desktopIcon

- enabled
- focusCycleRoot
- focusTraversalKeys
- focusTraversalPolicy
- focusTraversalPolicyProvider
- focusTraversalPolicySet
- focusable
- font
- foreground
- frameIcon
- glassPane
- icon
- iconifiable
- inheritsPopupMenu
- inputVerifier
- insets
- layeredPane
- layout
- maximizable
- maximum
- maximumSize
- minimumSize
- opaque
- preferredSize
- resizable
- rootPane
- selected
- title
- transferHandler
- verifyInputWhenFocusTarget

Vetoable Attributes

- closed
- icon
- maximum
- selected

SwingBuilder.JComponent

This page last changed on Nov 01, 2007 by [shemnon](#).

Here are attributes that all JComponent type nodes accept. For a better description of these properties consult the [JDK Documentation](#).

Attributes

- **visible** <boolean>
- **enabled** <boolean>
- **opaque** <boolean>
- **foreground** <Color>
- **background** <Color>
- **font**
- **toolTipText** <String>
- **preferredSize** <Dimension>
- **maximumSize** <Dimension>
- **minimumSize** <Dimension>
- **border** <Border>
- **alignmentY** <float>
- **alignmentX** <float>
- **componentPopupMenu** <JPopupMenu>
- **inheritsPopupMenu** <boolean>
- **autoScrolls** <boolean>
- **UI** <javax.swing.plaf.ComponentUI>
- **nextFocusableComponent** <Component>
- **requestFocusEnabled** <boolean>
- **verifyInputWhenFocusTarget** <boolean>
- **inputVerifier** <InputVerifier>
- **debugGraphicsOption** <int> DebugGraphics.NONE_OPTION, DebugGraphics.LOG_OPTION, DebugGraphics.FLASH_OPTION, DebugGraphics.BUFFERED_OPTION
- **transferHandler** <TransferHandler>
- **doubleBuffered** <boolean>
- **actionMap** <ActionMap>

SwingBuilder.Label

This page last changed on Mar 21, 2008 by [shemnon](#).

- [Generated Object](#)
- [Attributes](#)
- [Events](#)
- [Content](#)
- [Usage](#)
- [Examples](#)
- [Observable Attributes](#)

(Automatically generated from BeanInfo)

Generated Object

A `javax.swing.JLabel` is returned, unless the user passes in a subclass of `JLabel` as the value argument, in which case the value argument is returned.

Attributes

Declared in `javax.swing.JLabel`

- **UI** `<LabelUI>` The UI object that implements the Component's LookAndFeel.
- **disabledIcon** `<Icon>` The icon to display if the label is disabled.
- **displayedMnemonic** `<int>` The mnemonic keycode.
- **displayedMnemonicIndex** `<int>` the index into the String to draw the keyboard character mnemonic at
- **horizontalAlignment** `<int>` The alignment of the label's content along the X axis.
- **horizontalTextPosition** `<int>` The horizontal position of the label's text, relative to its image.
- **icon** `<Icon>` The icon this component will display.
- **iconTextGap** `<int>` If both the icon and text properties are set, this property defines the space between them.
- **labelFor** `<Component>` The component this is labelling.
- **text** `<String>` Defines the single line of text this component will display.
- **verticalAlignment** `<int>` The alignment of the label's contents along the Y axis.
- **verticalTextPosition** `<int>` The vertical position of the text relative to it's image.

Declared in `javax.swing.JComponent`

- **autoscrolls** `<boolean>` Determines if this component automatically scrolls its contents when dragged.
- **border** `<Border>` The component's border.
- **componentPopupMenu** `<JPopupMenu>` Popup to show
- **debugGraphicsOptions** `<int>` Diagnostic options for graphics operations.
- **inheritsPopupMenu** `<boolean>` Whether or not the JPopupMenu is inherited
- **inputVerifier** `<InputVerifier>` The component's input verifier.
- **opaque** `<boolean>` The component's opacity
- **toolTipText** `<String>` The text to display in a tool tip.
- **transferHandler** `<TransferHandler>` Mechanism for transfer of data to and from the component
- **verifyInputWhenFocusTarget** `<boolean>` Whether the Component verifies input before accepting focus.
- **UIClassID** `<String>`
- **accessibleContext** `<AccessibleContext>`
- **actionMap** `<ActionMap>`
- **doubleBuffered** `<boolean>`
- **graphics** `<Graphics>`
- **height** `<int>`
- **managingFocus** `<boolean>`
- **nextFocusableComponent** `<Component>`
- **optimizedDrawingEnabled** `<boolean>`
- **paintingTile** `<boolean>`

- **registeredKeyStrokes** <KeyStroke[]>
- **requestFocusEnabled** <boolean>
- **rootPane** <JRootPane>
- **topLevelAncestor** <Container>
- **validateRoot** <boolean>
- **visibleRect** <Rectangle>
- **width** <int>
- **x** <int>
- **y** <int>

Declared in java.awt.Container

- **alignmentX** <float>
- **alignmentY** <float>
- **componentCount** <int>
- **components** <Component[]>
- **focusCycleRoot** <boolean>
- **focusTraversalPolicy** <FocusTraversalPolicy>
- **focusTraversalPolicyProvider** <boolean>
- **focusTraversalPolicySet** <boolean>
- **insets** <Insets>
- **layout** <LayoutManager>
- **maximumSize** <Dimension>
- **minimumSize** <Dimension>
- **preferredSize** <Dimension>

Declared in java.awt.Component

- **background** <Color>
- **enabled** <boolean>
- **focusable** <boolean>
- **font**
- **foreground** <Color>
- **name** <String>
- **visible** <boolean>

Events

Declared in javax.swing.JComponent

- **vetoableChange** (PropertyChangeEvent) - part of VetoableChangeListener
- **ancestorMoved** (AncestorEvent) - part of AncestorListener
- **ancestorAdded** (AncestorEvent) - part of AncestorListener
- **ancestorRemoved** (AncestorEvent) - part of AncestorListener

Declared in java.awt.Container

- **componentAdded** (ContainerEvent) - part of ContainerListener
- **componentRemoved** (ContainerEvent) - part of ContainerListener

Declared in java.awt.Component

- **keyPressed** (KeyEvent) - part of KeyListener
- **keyReleased** (KeyEvent) - part of KeyListener
- **keyTyped** (KeyEvent) - part of KeyListener
- **componentHidden** (ComponentEvent) - part of ComponentListener
- **componentMoved** (ComponentEvent) - part of ComponentListener
- **componentResized** (ComponentEvent) - part of ComponentListener
- **componentShown** (ComponentEvent) - part of ComponentListener
- **hierarchyChanged** (HierarchyEvent) - part of HierarchyListener
- **mouseClicked** (MouseEvent) - part of MouseListener
- **mouseEntered** (MouseEvent) - part of MouseListener

- **mouseExited** (MouseEvent) - part of MouseListener
- **mousePressed** (MouseEvent) - part of MouseListener
- **mouseReleased** (MouseEvent) - part of MouseListener
- **mouseDragged** (MouseEvent) - part of MouseMotionListener
- **mouseMoved** (MouseEvent) - part of MouseMotionListener
- **propertyChange** (PropertyChangeEvent) - part of PropertyChangeListener
- **ancestorMoved** (HierarchyEvent) - part of HierarchyBoundsListener
- **ancestorResized** (HierarchyEvent) - part of HierarchyBoundsListener
- **focusGained** (FocusEvent) - part of FocusListener
- **focusLost** (FocusEvent) - part of FocusListener
- **mouseWheelMoved** (MouseEvent) - part of MouseWheelListener
- **caretPositionChanged** (InputMethodEvent) - part of InputMethodListener
- **inputMethodTextChanged** (InputMethodEvent) - part of InputMethodListener

Content

Usage

Examples

Observable Attributes

- UI
- alignmentX
- alignmentY
- background
- border
- component
- componentCount
- componentPopupMenu
- components
- containerListeners
- disabledIcon
- displayedMnemonic
- displayedMnemonicIndex
- enabled
- focusCycleRoot
- focusTraversalKeys
- focusTraversalPolicy
- focusTraversalPolicyProvider
- focusTraversalPolicySet
- focusable
- font
- foreground
- horizontalAlignment
- horizontalTextPosition
- icon
- iconTextGap
- inheritsPopupMenu
- inputVerifier
- insets
- labelFor
- layout
- maximumSize
- minimumSize
- opaque
- preferredSize
- text
- transferHandler
- verifyInputWhenFocusTarget
- verticalAlignment
- verticalTextPosition

SwingBuilder.layeredPane

This page last changed on Mar 21, 2008 by [shemnon](#).

- [Generated Object](#)
- [Attributes](#)
- [Events](#)
- [Content](#)
- [Usage](#)
- [Examples](#)
- [Observable Attributes](#)

(Automatically generated from BeanInfo)

Generated Object

A `javax.swing.JLayeredPane` is returned, unless the user passes in a subclass of `JLayeredPane` as the value argument, in which case the value argument is returned.

Attributes

Declared in `javax.swing.JComponent`

- **autoscrolls** <boolean> Determines if this component automatically scrolls its contents when dragged.
- **border** <Border> The component's border.
- **componentPopupMenu** <JPopupMenu> Popup to show
- **debugGraphicsOptions** <int> Diagnostic options for graphics operations.
- **inheritsPopupMenu** <boolean> Whether or not the JPopupMenu is inherited
- **inputVerifier** <InputVerifier> The component's input verifier.
- **opaque** <boolean> The component's opacity
- **toolTipText** <String> The text to display in a tool tip.
- **transferHandler** <TransferHandler> Mechanism for transfer of data to and from the component
- **verifyInputWhenFocusTarget** <boolean> Whether the Component verifies input before accepting focus.

- **UIClassID** <String>
- **accessibleContext** <AccessibleContext>
- **actionMap** <ActionMap>
- **doubleBuffered** <boolean>
- **graphics** <Graphics>
- **height** <int>
- **managingFocus** <boolean>
- **nextFocusableComponent** <Component>
- **optimizedDrawingEnabled** <boolean>
- **paintingTile** <boolean>
- **registeredKeyStrokes** <KeyStroke[]>
- **requestFocusEnabled** <boolean>
- **rootPane** <JRootPane>
- **topLevelAncestor** <Container>
- **validateRoot** <boolean>
- **visibleRect** <Rectangle>
- **width** <int>
- **x** <int>
- **y** <int>

Declared in `java.awt.Container`

- **alignmentX** <float>
- **alignmentY** <float>
- **componentCount** <int>
- **components** <Component[]>
- **focusCycleRoot** <boolean>

- **focusTraversalPolicy** <FocusTraversalPolicy>
- **focusTraversalPolicyProvider** <boolean>
- **focusTraversalPolicySet** <boolean>
- **insets** <Insets>
- **layout** <LayoutManager>
- **maximumSize** <Dimension>
- **minimumSize** <Dimension>
- **preferredSize** <Dimension>

Declared in java.awt.Component

- **background** <Color>
- **enabled** <boolean>
- **focusable** <boolean>
- **font**
- **foreground** <Color>
- **name** <String>
- **visible** <boolean>

Events

Declared in javax.swing.JComponent

- **vetoableChange** (PropertyChangeEvent) - part of VetoableChangeListener
- **ancestorMoved** (AncestorEvent) - part of AncestorListener
- **ancestorAdded** (AncestorEvent) - part of AncestorListener
- **ancestorRemoved** (AncestorEvent) - part of AncestorListener

Declared in java.awt.Container

- **componentAdded** (ContainerEvent) - part of ContainerListener
- **componentRemoved** (ContainerEvent) - part of ContainerListener

Declared in java.awt.Component

- **keyPressed** (KeyEvent) - part of KeyListener
- **keyReleased** (KeyEvent) - part of KeyListener
- **keyTyped** (KeyEvent) - part of KeyListener
- **componentHidden** (ComponentEvent) - part of ComponentListener
- **componentMoved** (ComponentEvent) - part of ComponentListener
- **componentResized** (ComponentEvent) - part of ComponentListener
- **componentShown** (ComponentEvent) - part of ComponentListener
- **hierarchyChanged** (HierarchyEvent) - part of HierarchyListener
- **mouseClicked** (MouseEvent) - part of MouseListener
- **mouseEntered** (MouseEvent) - part of MouseListener
- **mouseExited** (MouseEvent) - part of MouseListener
- **mousePressed** (MouseEvent) - part of MouseListener
- **mouseReleased** (MouseEvent) - part of MouseListener
- **mouseDragged** (MouseEvent) - part of MouseMotionListener
- **mouseMoved** (MouseEvent) - part of MouseMotionListener
- **propertyChange** (PropertyChangeEvent) - part of PropertyChangeListener
- **ancestorMoved** (HierarchyEvent) - part of HierarchyBoundsListener
- **ancestorResized** (HierarchyEvent) - part of HierarchyBoundsListener
- **focusGained** (FocusEvent) - part of FocusListener
- **focusLost** (FocusEvent) - part of FocusListener
- **mouseWheelMoved** (MouseEvent) - part of MouseWheelListener
- **caretPositionChanged** (InputMethodEvent) - part of InputMethodListener
- **inputMethodTextChanged** (InputMethodEvent) - part of InputMethodListener

Content

Usage

Examples

Observable Attributes

- alignmentX
- alignmentY
- background
- border
- component
- componentCount
- componentPopupMenu
- components
- containerListeners
- enabled
- focusCycleRoot
- focusTraversalKeys
- focusTraversalPolicy
- focusTraversalPolicyProvider
- focusTraversalPolicySet
- focusable
- font
- foreground
- inheritsPopupMenu
- inputVerifier
- insets
- layout
- maximumSize
- minimumSize
- opaque
- preferredSize
- transferHandler
- verifyInputWhenFocusTarget

SwingBuilder.lineBorder

This page last changed on Oct 25, 2007 by [shemnon](#).

Generated Object

A `javax.swing.border.LineBorder`, a border that consists of a colored line.

Value Argument

No value argument is accepted.

Attributes

`color`: is required.

- **color** <Color> The color of the line
- **roundedCorners** <boolean> Whether or not the border should appear rounded. Only effective with a thickness of 1, otherwise you will get a wierd quasi-bevel effect. Default is false.
- **thickness** <int> The thickness of the line, in pixels. Default is 1.
- **parent** <boolean> Whether or not this border is to be added to the parent JComponent

Content

`lineBorder()` is a leaf node, no child content is allowed.

Examples

```
panel(border:lineBorder(Color.RED))
```

```
panel {  
  lineBorder(color:Color.WHITE, thickness:3, parent:true)  
}
```

```
lineBorder(color:BLUE, roundedCorners:true)
```

SwingBuilder.list

This page last changed on Mar 21, 2008 by [shemnon](#).

- [Generated Object](#)
- [Attributes](#)
- [Events](#)
- [Content](#)
- [Usage](#)
- [Examples](#)
- [Observable Attributes](#)

(Automatically generated from BeanInfo)

Generated Object

A `javax.swing.JList` is returned, unless the user passes in a subclass of `JList` as the value argument, in which case the value argument is returned.

Attributes

Declared in `javax.swing.JList`

- **UI** `<ListUI>` The UI object that implements the Component's LookAndFeel.
- **cellRenderer** `<ListCellRenderer>` The component used to draw the cells.
- **dragEnabled** `<boolean>` determines whether automatic drag handling is enabled
- **fixedCellHeight** `<int>` Defines a fixed cell height when greater than zero.
- **fixedCellWidth** `<int>` Defines a fixed cell width when greater than zero.
- **layoutOrientation** `<int>` Defines the way list cells are layed out.
- **leadSelectionIndex** `<int>` The lead selection index.
- **model** `<ListModel>` The object that contains the data to be drawn by this `JList`.
- **prototypeCellValue** `<Object>` The cell prototype value, used to compute cell width and height.
- **selectedIndex** `<int>` The index of the selected cell.
- **selectionBackground** `<Color>` The background color of selected cells.
- **selectionForeground** `<Color>` The foreground color of selected cells.
- **selectionMode** `<int>` The selection mode.
- **selectionModel** `<ListSelectionModel>` The selection model, recording which cells are selected.
- **visibleRowCount** `<int>` The preferred number of cells that can be displayed without a scroll bar.

- **anchorSelectionIndex** `<int>`
- **firstVisibleIndex** `<int>`
- **lastVisibleIndex** `<int>`
- **maxSelectionIndex** `<int>`
- **minSelectionIndex** `<int>`
- **preferredScrollableViewportSize** `<Dimension>`
- **scrollableTracksViewportHeight** `<boolean>`
- **scrollableTracksViewportWidth** `<boolean>`
- **selectedIndices** `<int[]>`
- **selectedValue** `<Object>`
- **selectedValues** `<Object[]>`
- **selectionEmpty** `<boolean>`
- **valueIsAdjusting** `<boolean>`

Declared in `javax.swing.JComponent`

- **autoscrolls** `<boolean>` Determines if this component automatically scrolls its contents when dragged.
- **border** `<Border>` The component's border.
- **componentPopupMenu** `<JPopupMenu>` Popup to show
- **debugGraphicsOptions** `<int>` Diagnostic options for graphics operations.
- **inheritsPopupMenu** `<boolean>` Whether or not the `JPopupMenu` is inherited
- **inputVerifier** `<InputVerifier>` The component's input verifier.
- **opaque** `<boolean>` The component's opacity

- **toolTipText** <String> The text to display in a tool tip.
- **transferHandler** <TransferHandler> Mechanism for transfer of data to and from the component
- **verifyInputWhenFocusTarget** <boolean> Whether the Component verifies input before accepting focus.
- **UIClassID** <String>
- **accessibleContext** <AccessibleContext>
- **actionMap** <ActionMap>
- **doubleBuffered** <boolean>
- **graphics** <Graphics>
- **height** <int>
- **managingFocus** <boolean>
- **nextFocusableComponent** <Component>
- **optimizedDrawingEnabled** <boolean>
- **paintingTile** <boolean>
- **registeredKeyStrokes** <KeyStroke[]>
- **requestFocusEnabled** <boolean>
- **rootPane** <JRootPane>
- **topLevelAncestor** <Container>
- **validateRoot** <boolean>
- **visibleRect** <Rectangle>
- **width** <int>
- **x** <int>
- **y** <int>

Declared in java.awt.Container

- **alignmentX** <float>
- **alignmentY** <float>
- **componentCount** <int>
- **components** <Component[]>
- **focusCycleRoot** <boolean>
- **focusTraversalPolicy** <FocusTraversalPolicy>
- **focusTraversalPolicyProvider** <boolean>
- **focusTraversalPolicySet** <boolean>
- **insets** <Insets>
- **layout** <LayoutManager>
- **maximumSize** <Dimension>
- **minimumSize** <Dimension>
- **preferredSize** <Dimension>

Declared in java.awt.Component

- **background** <Color>
- **enabled** <boolean>
- **focusable** <boolean>
- **font**
- **foreground** <Color>
- **name** <String>
- **visible** <boolean>

Events

Declared in javax.swing.JList

- **valueChanged** (ListSelectionEvent) - part of ListSelectionListener

Declared in javax.swing.JComponent

- **vetoableChange** (PropertyChangeEvent) - part of VetoableChangeListener
- **ancestorMoved** (AncestorEvent) - part of AncestorListener
- **ancestorAdded** (AncestorEvent) - part of AncestorListener

- **ancestorRemoved** (AncestorEvent) - part of AncestorListener

Declared in java.awt.Container

- **componentAdded** (ContainerEvent) - part of ContainerListener
- **componentRemoved** (ContainerEvent) - part of ContainerListener

Declared in java.awt.Component

- **keyPressed** (KeyEvent) - part of KeyListener
- **keyReleased** (KeyEvent) - part of KeyListener
- **keyTyped** (KeyEvent) - part of KeyListener
- **componentHidden** (ComponentEvent) - part of ComponentListener
- **componentMoved** (ComponentEvent) - part of ComponentListener
- **componentResized** (ComponentEvent) - part of ComponentListener
- **componentShown** (ComponentEvent) - part of ComponentListener
- **hierarchyChanged** (HierarchyEvent) - part of HierarchyListener
- **mouseClicked** (MouseEvent) - part of MouseListener
- **mouseEntered** (MouseEvent) - part of MouseListener
- **mouseExited** (MouseEvent) - part of MouseListener
- **mousePressed** (MouseEvent) - part of MouseListener
- **mouseReleased** (MouseEvent) - part of MouseListener
- **mouseDragged** (MouseEvent) - part of MouseMotionListener
- **mouseMoved** (MouseEvent) - part of MouseMotionListener
- **propertyChange** (PropertyChangeEvent) - part of PropertyChangeListener
- **ancestorMoved** (HierarchyEvent) - part of HierarchyBoundsListener
- **ancestorResized** (HierarchyEvent) - part of HierarchyBoundsListener
- **focusGained** (FocusEvent) - part of FocusListener
- **focusLost** (FocusEvent) - part of FocusListener
- **mouseWheelMoved** (MouseWheelEvent) - part of MouseWheelListener
- **caretPositionChanged** (InputMethodEvent) - part of InputMethodListener
- **inputMethodTextChanged** (InputMethodEvent) - part of InputMethodListener

Content

Usage

Examples

Observable Attributes

- UI
- alignmentX
- alignmentY
- background
- border
- cellRenderer
- component
- componentCount
- componentPopupMenu
- components
- containerListeners
- enabled
- fixedCellHeight
- fixedCellWidth
- focusCycleRoot
- focusTraversalKeys
- focusTraversalPolicy
- focusTraversalPolicyProvider
- focusTraversalPolicySet
- focusable

- font
- foreground
- inheritsPopupMenu
- inputVerifier
- insets
- layout
- layoutOrientation
- maximumSize
- minimumSize
- model
- opaque
- preferredSize
- prototypeCellValue
- selectionBackground
- selectionForeground
- selectionModel
- transferHandler
- verifyInputWhenFocusTarget
- visibleRowCount

SwingBuilder.loweredBevelBorder

This page last changed on Oct 25, 2007 by [shemnon](#).

Generated Object

A `javax.swing.border.BevelBorder` with type `BevelBorder.LOWERED`, a border that looks recessed into the panel.

Value Argument

`loweredBevelBorder()` takes no value arguments.

Attributes

If either `shadow:` or `highlight:` are specified, both must be specified.

If any of `shadowInner:`, `shadowOuter:`, `highlightInner:`, or `highlightOuter` are specified, all must be specified.

The attributes `shadow:` and `highlight:` are mutually exclusive to `shadowInner:`, `shadowOuter:`, `highlightInner:`, and `highlightOuter:`.

- **highlight** <Color> The color that is to be painted on the highlight side of the bevel.
- **shadow** <Color> The color that is to be painted on the shadow side of the bevel.
- **highlightInner** <Color> The inner color that is to be painted on the highlight side of the bevel.
- **highlightOuter** <Color> The outer color that is to be painted on the highlight side of the bevel.
- **shadowInner** <Color> The inner color that is to be painted on the shadow side of the bevel.
- **shadowOuter** <Color> The outer color that is to be painted on the shadow side of the bevel.
- **parent** <boolean> Whether or not this border is to be added to the parent `JComponent`.

Content

`loweredBevelBorder()` is a leaf node, no child content is allowed.

Examples

```
panel(border:loweredBevelBorder())
```

```
panel {
  loweredBevelBorder(shadow:Color.RED, highlight:Color.PINK, parent:true)
}
```

```
loweredBevelBorder(
  shadowOuter:Color.BLACK, shadowInner:Color.GREY,
  highlightOuter:Color.RED, highlightInner:Color.PINK)
```

SwingBuilder.map

This page last changed on Mar 21, 2008 by [shemnon](#).

- [Generated Object](#)
- [Attributes](#)
- [Events](#)
- [Content](#)
- [Usage](#)
- [Examples](#)

(Automatically generated from BeanInfo)

Generated Object

A `java.util.Map` is returned, unless the user passes in a subclass of `Map` as the value argument, in which case the value argument is returned.

Attributes

Declared in `java.util.Map`

- **empty** <boolean>

Events

Content

Usage

Examples

SwingBuilder.matteBorder

This page last changed on Mar 21, 2008 by [shemnon](#).

- [Generated Object](#)
- [Attributes](#)
- [Events](#)
- [Content](#)
- [Usage](#)
- [Examples](#)

(Automatically generated from BeanInfo)

Generated Object

A `javax.swing.border.MatteBorder` is returned, unless the user passes in a subclass of `MatteBorder` as the value argument, in which case the value argument is returned.

Attributes

Declared in `javax.swing.border.MatteBorder`

- **matteColor** <Color>
- **tileIcon** <Icon>

Declared in `javax.swing.border.EmptyBorder`

- **borderInsets** <Insets>

Declared in `javax.swing.border.AbstractBorder`

- **borderOpaque** <boolean>

Events

Content

Usage

Examples

SwingBuilder.menu

This page last changed on Mar 21, 2008 by [shemnon](#).

- [Generated Object](#)
- [Attributes](#)
- [Events](#)
- [Content](#)
- [Usage](#)
- [Examples](#)
- [Observable Attributes](#)

(Automatically generated from BeanInfo)

Generated Object

A `javax.swing.JMenu` is returned, unless the user passes in a subclass of `JMenu` as the value argument, in which case the value argument is returned.

Attributes

Declared in `javax.swing.JMenu`

- **delay** <int> The delay between menu selection and making the popup menu visible
- **popupMenuVisible** <boolean> The popup menu's visibility
- **itemCount** <int>
- **menuComponentCount** <int>
- **menuComponents** <Component[]>
- **popupMenu** <JPopupMenu>
- **tearOff** <boolean>
- **topLevelMenu** <boolean>

Declared in `javax.swing.JMenuItem`

- **accelerator** <KeyStroke> The keystroke combination which will invoke the `JMenuItem`'s actionlisteners without navigating the menu hierarchy
- **armed** <boolean> Mouse release will fire an action event
- **subElements** <MenuElement[]>

Declared in `javax.swing.AbstractButton`

- **UI** <ButtonUI> The UI object that implements the LookAndFeel.
- **action** <Action> the Action instance connected with this ActionEvent source
- **borderPainted** <boolean> Whether the border should be painted.
- **contentAreaFilled** <boolean> Whether the button should paint the content area or leave it transparent.
- **disabledIcon** <Icon> The disabled icon for the button.
- **disabledSelectedIcon** <Icon> The disabled selection icon for the button.
- **displayedMnemonicIndex** <int> the index into the String to draw the keyboard character mnemonic at
- **focusPainted** <boolean> Whether focus should be painted
- **horizontalAlignment** <int> The horizontal alignment of the icon and text.
- **horizontalTextPosition** <int> The horizontal position of the text relative to the icon.
- **icon** <Icon> The button's default icon
- **iconTextGap** <int> If both the icon and text properties are set, this property defines the space between them.
- **label** <String> Replace by `setText(text)`
- **margin** <Insets> The space between the button's border and the label.
- **mnemonic** <int> the keyboard character mnemonic
- **model** <ButtonModel> Model that the Button uses.
- **pressedIcon** <Icon> The pressed icon for the button.

- **rolloverEnabled** <boolean> Whether rollover effects should be enabled.
- **rolloverIcon** <Icon> The rollover icon for the button.
- **rolloverSelectedIcon** <Icon> The rollover selected icon for the button.
- **selectedIcon** <Icon> The selected icon for the button.
- **text** <String> The button's text.
- **verticalAlignment** <int> The vertical alignment of the icon and text.
- **verticalTextPosition** <int> The vertical position of the text relative to the icon.
- **actionCommand** <String>
- **multiClickThreshold** <long>
- **selected** <boolean>
- **selectedObjects** <Object[]>

Declared in javax.swing.JComponent

- **autoscrolls** <boolean> Determines if this component automatically scrolls its contents when dragged.
- **border** <Border> The component's border.
- **componentPopupMenu** <JPopupMenu> Popup to show
- **debugGraphicsOptions** <int> Diagnostic options for graphics operations.
- **inheritsPopupMenu** <boolean> Whether or not the JPopupMenu is inherited
- **inputVerifier** <InputVerifier> The component's input verifier.
- **opaque** <boolean> The component's opacity
- **toolTipText** <String> The text to display in a tool tip.
- **transferHandler** <TransferHandler> Mechanism for transfer of data to and from the component
- **verifyInputWhenFocusTarget** <boolean> Whether the Component verifies input before accepting focus.
- **UIClassID** <String>
- **accessibleContext** <AccessibleContext>
- **actionMap** <ActionMap>
- **doubleBuffered** <boolean>
- **graphics** <Graphics>
- **height** <int>
- **managingFocus** <boolean>
- **nextFocusableComponent** <Component>
- **optimizedDrawingEnabled** <boolean>
- **paintingTile** <boolean>
- **registeredKeyStrokes** <KeyStroke[]>
- **requestFocusEnabled** <boolean>
- **rootPane** <JRootPane>
- **topLevelAncestor** <Container>
- **validateRoot** <boolean>
- **visibleRect** <Rectangle>
- **width** <int>
- **x** <int>
- **y** <int>

Declared in java.awt.Container

- **alignmentX** <float>
- **alignmentY** <float>
- **componentCount** <int>
- **components** <Component[]>
- **focusCycleRoot** <boolean>
- **focusTraversalPolicy** <FocusTraversalPolicy>
- **focusTraversalPolicyProvider** <boolean>
- **focusTraversalPolicySet** <boolean>
- **insets** <Insets>
- **layout** <LayoutManager>
- **maximumSize** <Dimension>
- **minimumSize** <Dimension>
- **preferredSize** <Dimension>

Declared in java.awt.Component

- **background** <Color>
- **enabled** <boolean>
- **focusable** <boolean>
- **font**
- **foreground** <Color>
- **name** <String>
- **visible** <boolean>

Events

Declared in javax.swing.JMenu

- **menuCanceled** (MenuEvent) - part of MenuListener
- **menuDeselected** (MenuEvent) - part of MenuListener
- **menuSelected** (MenuEvent) - part of MenuListener

Declared in javax.swing.JMenuItem

- **menuKeyPressed** (MenuKeyEvent) - part of MenuKeyListener
- **menuKeyReleased** (MenuKeyEvent) - part of MenuKeyListener
- **menuKeyTyped** (MenuKeyEvent) - part of MenuKeyListener
- **menuDragMouseDragged** (MenuDragMouseEvent) - part of MenuDragMouseListener
- **menuDragMouseEntered** (MenuDragMouseEvent) - part of MenuDragMouseListener
- **menuDragMouseExited** (MenuDragMouseEvent) - part of MenuDragMouseListener
- **menuDragMouseReleased** (MenuDragMouseEvent) - part of MenuDragMouseListener

Declared in javax.swing.AbstractButton

- **itemStateChanged** (ItemEvent) - part of ItemListener
- **actionPerformed** (ActionEvent) - part of ActionListener
- **stateChanged** (ChangeEvent) - part of ChangeListener

Declared in javax.swing.JComponent

- **vetoableChange** (PropertyChangeEvent) - part of VetoableChangeListener
- **ancestorMoved** (AncestorEvent) - part of AncestorListener
- **ancestorAdded** (AncestorEvent) - part of AncestorListener
- **ancestorRemoved** (AncestorEvent) - part of AncestorListener

Declared in java.awt.Container

- **componentAdded** (ContainerEvent) - part of ContainerListener
- **componentRemoved** (ContainerEvent) - part of ContainerListener

Declared in java.awt.Component

- **keyPressed** (KeyEvent) - part of KeyListener
- **keyReleased** (KeyEvent) - part of KeyListener
- **keyTyped** (KeyEvent) - part of KeyListener
- **componentHidden** (ComponentEvent) - part of ComponentListener
- **componentMoved** (ComponentEvent) - part of ComponentListener
- **componentResized** (ComponentEvent) - part of ComponentListener
- **componentShown** (ComponentEvent) - part of ComponentListener
- **hierarchyChanged** (HierarchyEvent) - part of HierarchyListener
- **mouseClicked** (MouseEvent) - part of MouseListener
- **mouseEntered** (MouseEvent) - part of MouseListener
- **mouseExited** (MouseEvent) - part of MouseListener
- **mousePressed** (MouseEvent) - part of MouseListener
- **mouseReleased** (MouseEvent) - part of MouseListener

- **mouseDragged** (MouseEvent) - part of MouseMotionListener
- **mouseMoved** (MouseEvent) - part of MouseMotionListener
- **propertyChange** (PropertyChangeEvent) - part of PropertyChangeListener
- **ancestorMoved** (HierarchyEvent) - part of HierarchyBoundsListener
- **ancestorResized** (HierarchyEvent) - part of HierarchyBoundsListener
- **focusGained** (FocusEvent) - part of FocusListener
- **focusLost** (FocusEvent) - part of FocusListener
- **mouseWheelMoved** (MouseEvent) - part of MouseWheelListener
- **caretPositionChanged** (InputMethodEvent) - part of InputMethodListener
- **inputMethodTextChanged** (InputMethodEvent) - part of InputMethodListener

Content

Usage

Examples

Observable Attributes

- UI
- accelerator
- action
- alignmentX
- alignmentY
- background
- border
- borderPainted
- componentCount
- componentPopupMenu
- components
- containerListeners
- contentAreaFilled
- disabledIcon
- disabledSelectedIcon
- displayedMnemonicIndex
- enabled
- focusCycleRoot
- focusPainted
- focusTraversalKeys
- focusTraversalPolicy
- focusTraversalPolicyProvider
- focusTraversalPolicySet
- focusable
- font
- foreground
- horizontalAlignment
- horizontalTextPosition
- icon
- iconTextGap
- inheritsPopupMenu
- inputVerifier
- insets
- label
- layout
- margin
- maximumSize
- minimumSize
- mnemonic
- model
- opaque
- preferredSize
- pressedIcon

- rolloverEnabled
- rolloverIcon
- rolloverSelectedIcon
- selectedIcon
- text
- transferHandler
- verifyInputWhenFocusTarget
- verticalAlignment
- verticalTextPosition

SwingBuilder.menuBar

This page last changed on Mar 21, 2008 by [shemnon](#).

- [Generated Object](#)
- [Attributes](#)
- [Events](#)
- [Content](#)
- [Usage](#)
- [Examples](#)
- [Observable Attributes](#)

(Automatically generated from BeanInfo)

Generated Object

A `javax.swing.JMenuBar` is returned, unless the user passes in a subclass of `JMenuBar` as the value argument, in which case the value argument is returned.

Attributes

Declared in `javax.swing.JMenuBar`

- **UI** <MenuBarUI> The UI object that implements the Component's LookAndFeel.
- **borderPainted** <boolean> Whether the border should be painted.
- **margin** <Insets> The space between the menubar's border and its contents
- **selectionModel** <SingleSelectionModel> The selection model, recording which child is selected.

- **helpMenu** <JMenu>
- **menuCount** <int>
- **selected** <boolean>
- **subElements** <MenuElement[]>

Declared in `javax.swing.JComponent`

- **autoscrolls** <boolean> Determines if this component automatically scrolls its contents when dragged.
- **border** <Border> The component's border.
- **componentPopupMenu** <JPopupMenu> Popup to show
- **debugGraphicsOptions** <int> Diagnostic options for graphics operations.
- **inheritsPopupMenu** <boolean> Whether or not the JPopupMenu is inherited
- **inputVerifier** <InputVerifier> The component's input verifier.
- **opaque** <boolean> The component's opacity
- **toolTipText** <String> The text to display in a tool tip.
- **transferHandler** <TransferHandler> Mechanism for transfer of data to and from the component
- **verifyInputWhenFocusTarget** <boolean> Whether the Component verifies input before accepting focus.

- **UIClassID** <String>
- **accessibleContext** <AccessibleContext>
- **actionMap** <ActionMap>
- **doubleBuffered** <boolean>
- **graphics** <Graphics>
- **height** <int>
- **managingFocus** <boolean>
- **nextFocusableComponent** <Component>
- **optimizedDrawingEnabled** <boolean>
- **paintingTile** <boolean>
- **registeredKeyStrokes** <KeyStroke[]>
- **requestFocusEnabled** <boolean>
- **rootPane** <JRootPane>
- **topLevelAncestor** <Container>
- **validateRoot** <boolean>

- **visibleRect** <Rectangle>
- **width** <int>
- **x** <int>
- **y** <int>

Declared in java.awt.Container

- **alignmentX** <float>
- **alignmentY** <float>
- **componentCount** <int>
- **components** <Component[]>
- **focusCycleRoot** <boolean>
- **focusTraversalPolicy** <FocusTraversalPolicy>
- **focusTraversalPolicyProvider** <boolean>
- **focusTraversalPolicySet** <boolean>
- **insets** <Insets>
- **layout** <LayoutManager>
- **maximumSize** <Dimension>
- **minimumSize** <Dimension>
- **preferredSize** <Dimension>

Declared in java.awt.Component

- **background** <Color>
- **enabled** <boolean>
- **focusable** <boolean>
- **font**
- **foreground** <Color>
- **name** <String>
- **visible** <boolean>

Events

Declared in javax.swing.JComponent

- **vetoableChange** (PropertyChangeEvent) - part of VetoableChangeListener
- **ancestorMoved** (AncestorEvent) - part of AncestorListener
- **ancestorAdded** (AncestorEvent) - part of AncestorListener
- **ancestorRemoved** (AncestorEvent) - part of AncestorListener

Declared in java.awt.Container

- **componentAdded** (ContainerEvent) - part of ContainerListener
- **componentRemoved** (ContainerEvent) - part of ContainerListener

Declared in java.awt.Component

- **keyPressed** (KeyEvent) - part of KeyListener
- **keyReleased** (KeyEvent) - part of KeyListener
- **keyTyped** (KeyEvent) - part of KeyListener
- **componentHidden** (ComponentEvent) - part of ComponentListener
- **componentMoved** (ComponentEvent) - part of ComponentListener
- **componentResized** (ComponentEvent) - part of ComponentListener
- **componentShown** (ComponentEvent) - part of ComponentListener
- **hierarchyChanged** (HierarchyEvent) - part of HierarchyListener
- **mouseClicked** (MouseEvent) - part of MouseListener
- **mouseEntered** (MouseEvent) - part of MouseListener
- **mouseExited** (MouseEvent) - part of MouseListener
- **mousePressed** (MouseEvent) - part of MouseListener
- **mouseReleased** (MouseEvent) - part of MouseListener
- **mouseDragged** (MouseEvent) - part of MouseMotionListener
- **mouseMoved** (MouseEvent) - part of MouseMotionListener

- **propertyChange** (PropertyChangeEvent) - part of PropertyChangeListener
- **ancestorMoved** (HierarchyEvent) - part of HierarchyBoundsListener
- **ancestorResized** (HierarchyEvent) - part of HierarchyBoundsListener
- **focusGained** (FocusEvent) - part of FocusListener
- **focusLost** (FocusEvent) - part of FocusListener
- **mouseWheelMoved** (MouseEvent) - part of MouseWheelListener
- **caretPositionChanged** (InputMethodEvent) - part of InputMethodListener
- **inputMethodTextChanged** (InputMethodEvent) - part of InputMethodListener

Content

Usage

Examples

Observable Attributes

- UI
- alignmentX
- alignmentY
- background
- border
- borderPainted
- componentCount
- componentPopupMenu
- components
- containerListeners
- enabled
- focusCycleRoot
- focusTraversalKeys
- focusTraversalPolicy
- focusTraversalPolicyProvider
- focusTraversalPolicySet
- focusable
- font
- foreground
- inheritsPopupMenu
- inputVerifier
- insets
- layout
- margin
- maximumSize
- minimumSize
- opaque
- preferredSize
- selectionModel
- transferHandler
- verifyInputWhenFocusTarget

SwingBuilder.menuItem

This page last changed on Mar 21, 2008 by [shemnon](#).

- [Generated Object](#)
- [Attributes](#)
- [Events](#)
- [Content](#)
- [Usage](#)
- [Examples](#)
- [Observable Attributes](#)

(Automatically generated from BeanInfo)

Generated Object

A `javax.swing.JMenuItem` is returned, unless the user passes in a subclass of `JMenuItem` as the value argument, in which case the value argument is returned.

Attributes

Declared in `javax.swing.JMenuItem`

- **accelerator** <`KeyStroke`> The keystroke combination which will invoke the `JMenuItem`'s actionlisteners without navigating the menu hierarchy
- **armed** <`boolean`> Mouse release will fire an action event
- **subElements** <`MenuElement[]`>

Declared in `javax.swing.AbstractButton`

- **UI** <`ButtonUI`> The UI object that implements the `LookAndFeel`.
- **action** <`Action`> the `Action` instance connected with this `ActionEvent` source
- **borderPainted** <`boolean`> Whether the border should be painted.
- **contentAreaFilled** <`boolean`> Whether the button should paint the content area or leave it transparent.
- **disabledIcon** <`Icon`> The disabled icon for the button.
- **disabledSelectedIcon** <`Icon`> The disabled selection icon for the button.
- **displayedMnemonicIndex** <`int`> the index into the `String` to draw the keyboard character mnemonic at
- **focusPainted** <`boolean`> Whether focus should be painted
- **horizontalAlignment** <`int`> The horizontal alignment of the icon and text.
- **horizontalTextPosition** <`int`> The horizontal position of the text relative to the icon.
- **icon** <`Icon`> The button's default icon
- **iconTextGap** <`int`> If both the icon and text properties are set, this property defines the space between them.
- **label** <`String`> Replace by `setText(text)`
- **margin** <`Insets`> The space between the button's border and the label.
- **mnemonic** <`int`> the keyboard character mnemonic
- **model** <`ButtonModel`> Model that the Button uses.
- **pressedIcon** <`Icon`> The pressed icon for the button.
- **rolloverEnabled** <`boolean`> Whether rollover effects should be enabled.
- **rolloverIcon** <`Icon`> The rollover icon for the button.
- **rolloverSelectedIcon** <`Icon`> The rollover selected icon for the button.
- **selectedIcon** <`Icon`> The selected icon for the button.
- **text** <`String`> The button's text.
- **verticalAlignment** <`int`> The vertical alignment of the icon and text.
- **verticalTextPosition** <`int`> The vertical position of the text relative to the icon.

- **actionCommand** <`String`>
- **multiClickThreshold** <`long`>
- **selected** <`boolean`>
- **selectedObjects** <`Object[]`>

Declared in javax.swing.JComponent

- **autoscrolls** <boolean> Determines if this component automatically scrolls its contents when dragged.
- **border** <Border> The component's border.
- **componentPopupMenu** <JPopupMenu> Popup to show
- **debugGraphicsOptions** <int> Diagnostic options for graphics operations.
- **inheritsPopupMenu** <boolean> Whether or not the JPopupMenu is inherited
- **inputVerifier** <InputVerifier> The component's input verifier.
- **opaque** <boolean> The component's opacity
- **toolTipText** <String> The text to display in a tool tip.
- **transferHandler** <TransferHandler> Mechanism for transfer of data to and from the component
- **verifyInputWhenFocusTarget** <boolean> Whether the Component verifies input before accepting focus.

- **UIClassID** <String>
- **accessibleContext** <AccessibleContext>
- **actionMap** <ActionMap>
- **doubleBuffered** <boolean>
- **graphics** <Graphics>
- **height** <int>
- **managingFocus** <boolean>
- **nextFocusableComponent** <Component>
- **optimizedDrawingEnabled** <boolean>
- **paintingTile** <boolean>
- **registeredKeyStrokes** <KeyStroke[]>
- **requestFocusEnabled** <boolean>
- **rootPane** <JRootPane>
- **topLevelAncestor** <Container>
- **validateRoot** <boolean>
- **visibleRect** <Rectangle>
- **width** <int>
- **x** <int>
- **y** <int>

Declared in java.awt.Container

- **alignmentX** <float>
- **alignmentY** <float>
- **componentCount** <int>
- **components** <Component[]>
- **focusCycleRoot** <boolean>
- **focusTraversalPolicy** <FocusTraversalPolicy>
- **focusTraversalPolicyProvider** <boolean>
- **focusTraversalPolicySet** <boolean>
- **insets** <Insets>
- **layout** <LayoutManager>
- **maximumSize** <Dimension>
- **minimumSize** <Dimension>
- **preferredSize** <Dimension>

Declared in java.awt.Component

- **background** <Color>
- **enabled** <boolean>
- **focusable** <boolean>
- **font**
- **foreground** <Color>
- **name** <String>
- **visible** <boolean>

Events

Declared in javax.swing.JMenuItem

- **menuKeyPressed** (MenuKeyEvent) - part of MenuKeyListener
- **menuKeyReleased** (MenuKeyEvent) - part of MenuKeyListener
- **menuKeyTyped** (MenuKeyEvent) - part of MenuKeyListener
- **menuDragMouseDragged** (MenuDragMouseEvent) - part of MenuDragMouseListener
- **menuDragMouseEntered** (MenuDragMouseEvent) - part of MenuDragMouseListener
- **menuDragMouseExited** (MenuDragMouseEvent) - part of MenuDragMouseListener
- **menuDragMouseReleased** (MenuDragMouseEvent) - part of MenuDragMouseListener

Declared in javax.swing.AbstractButton

- **itemStateChanged** (ItemEvent) - part of ItemListener
- **actionPerformed** (ActionEvent) - part of ActionListener
- **stateChanged** (ChangeEvent) - part of ChangeListener

Declared in javax.swing.JComponent

- **vetoableChange** (PropertyChangeEvent) - part of VetoableChangeListener
- **ancestorMoved** (AncestorEvent) - part of AncestorListener
- **ancestorAdded** (AncestorEvent) - part of AncestorListener
- **ancestorRemoved** (AncestorEvent) - part of AncestorListener

Declared in java.awt.Container

- **componentAdded** (ContainerEvent) - part of ContainerListener
- **componentRemoved** (ContainerEvent) - part of ContainerListener

Declared in java.awt.Component

- **keyPressed** (KeyEvent) - part of KeyListener
- **keyReleased** (KeyEvent) - part of KeyListener
- **keyTyped** (KeyEvent) - part of KeyListener
- **componentHidden** (ComponentEvent) - part of ComponentListener
- **componentMoved** (ComponentEvent) - part of ComponentListener
- **componentResized** (ComponentEvent) - part of ComponentListener
- **componentShown** (ComponentEvent) - part of ComponentListener
- **hierarchyChanged** (HierarchyEvent) - part of HierarchyListener
- **mouseClicked** (MouseEvent) - part of MouseListener
- **mouseEntered** (MouseEvent) - part of MouseListener
- **mouseExited** (MouseEvent) - part of MouseListener
- **mousePressed** (MouseEvent) - part of MouseListener
- **mouseReleased** (MouseEvent) - part of MouseListener
- **mouseDragged** (MouseEvent) - part of MouseMotionListener
- **mouseMoved** (MouseEvent) - part of MouseMotionListener
- **propertyChange** (PropertyChangeEvent) - part of PropertyChangeListener
- **ancestorMoved** (HierarchyEvent) - part of HierarchyBoundsListener
- **ancestorResized** (HierarchyEvent) - part of HierarchyBoundsListener
- **focusGained** (FocusEvent) - part of FocusListener
- **focusLost** (FocusEvent) - part of FocusListener
- **mouseWheelMoved** (MouseWheelEvent) - part of MouseWheelListener
- **caretPositionChanged** (InputMethodEvent) - part of InputMethodListener
- **inputMethodTextChanged** (InputMethodEvent) - part of InputMethodListener

Content

Usage

Examples

Observable Attributes

- UI
- accelerator
- action
- alignmentX
- alignmentY
- background
- border
- borderPainted
- componentCount
- componentPopupMenu
- components
- containerListeners
- contentAreaFilled
- disabledIcon
- disabledSelectedIcon
- displayedMnemonicIndex
- enabled
- focusCycleRoot
- focusPainted
- focusTraversalKeys
- focusTraversalPolicy
- focusTraversalPolicyProvider
- focusTraversalPolicySet
- focusable
- font
- foreground
- horizontalAlignment
- horizontalTextPosition
- icon
- iconTextGap
- inheritsPopupMenu
- inputVerifier
- insets
- label
- layout
- margin
- maximumSize
- minimumSize
- mnemonic
- model
- opaque
- preferredSize
- pressedIcon
- rolloverEnabled
- rolloverIcon
- rolloverSelectedIcon
- selectedIcon
- text
- transferHandler
- verifyInputWhenFocusTarget
- verticalAlignment
- verticalTextPosition

SwingBuilder.optionPane

This page last changed on Mar 21, 2008 by [shemnon](#).

- [Generated Object](#)
- [Attributes](#)
- [Events](#)
- [Content](#)
- [Usage](#)
- [Examples](#)
- [Observable Attributes](#)

(Automatically generated from BeanInfo)

Generated Object

A `javax.swing.JOptionPane` is returned, unless the user passes in a subclass of `JOptionPane` as the value argument, in which case the value argument is returned.

Attributes

Declared in `javax.swing.JOptionPane`

- **UI** <OptionPaneUI> The UI object that implements the optionpane's LookAndFeel.
 - **icon** <Icon> The option pane's type icon.
 - **initialSelectionValue** <Object> The option pane's initial selection value object.
 - **initialValue** <Object> The option pane's initial value object.
 - **inputValue** <Object> The option pane's input value object.
 - **message** <Object> The optionpane's message object.
 - **messageType** <int> The option pane's message type.
 - **optionType** <int> The option pane's option type.
 - **options** <Object[]> The option pane's options objects.
 - **selectionValues** <Object[]> The option pane's selection values.
 - **value** <Object> The option pane's value object.
 - **wantsInput** <boolean> Flag which allows the user to input a value.
-
- **maxCharactersPerLineCount** <int>

Declared in `javax.swing.JComponent`

- **autoscrolls** <boolean> Determines if this component automatically scrolls its contents when dragged.
 - **border** <Border> The component's border.
 - **componentPopupMenu** <JPopupMenu> Popup to show
 - **debugGraphicsOptions** <int> Diagnostic options for graphics operations.
 - **inheritsPopupMenu** <boolean> Whether or not the JPopupMenu is inherited
 - **inputVerifier** <InputVerifier> The component's input verifier.
 - **opaque** <boolean> The component's opacity
 - **toolTipText** <String> The text to display in a tool tip.
 - **transferHandler** <TransferHandler> Mechanism for transfer of data to and from the component
 - **verifyInputWhenFocusTarget** <boolean> Whether the Component verifies input before accepting focus.
-
- **UIClassID** <String>
 - **accessibleContext** <AccessibleContext>
 - **actionMap** <ActionMap>
 - **doubleBuffered** <boolean>
 - **graphics** <Graphics>
 - **height** <int>
 - **managingFocus** <boolean>
 - **nextFocusableComponent** <Component>
 - **optimizedDrawingEnabled** <boolean>
 - **paintingTile** <boolean>

- **registeredKeyStrokes** <KeyStroke[]>
- **requestFocusEnabled** <boolean>
- **rootPane** <JRootPane>
- **topLevelAncestor** <Container>
- **validateRoot** <boolean>
- **visibleRect** <Rectangle>
- **width** <int>
- **x** <int>
- **y** <int>

Declared in java.awt.Container

- **alignmentX** <float>
- **alignmentY** <float>
- **componentCount** <int>
- **components** <Component[]>
- **focusCycleRoot** <boolean>
- **focusTraversalPolicy** <FocusTraversalPolicy>
- **focusTraversalPolicyProvider** <boolean>
- **focusTraversalPolicySet** <boolean>
- **insets** <Insets>
- **layout** <LayoutManager>
- **maximumSize** <Dimension>
- **minimumSize** <Dimension>
- **preferredSize** <Dimension>

Declared in java.awt.Component

- **background** <Color>
- **enabled** <boolean>
- **focusable** <boolean>
- **font**
- **foreground** <Color>
- **name** <String>
- **visible** <boolean>

Events

Declared in javax.swing.JComponent

- **vetoableChange** (PropertyChangeEvent) - part of VetoableChangeListener
- **ancestorMoved** (AncestorEvent) - part of AncestorListener
- **ancestorAdded** (AncestorEvent) - part of AncestorListener
- **ancestorRemoved** (AncestorEvent) - part of AncestorListener

Declared in java.awt.Container

- **componentAdded** (ContainerEvent) - part of ContainerListener
- **componentRemoved** (ContainerEvent) - part of ContainerListener

Declared in java.awt.Component

- **keyPressed** (KeyEvent) - part of KeyListener
- **keyReleased** (KeyEvent) - part of KeyListener
- **keyTyped** (KeyEvent) - part of KeyListener
- **componentHidden** (ComponentEvent) - part of ComponentListener
- **componentMoved** (ComponentEvent) - part of ComponentListener
- **componentResized** (ComponentEvent) - part of ComponentListener
- **componentShown** (ComponentEvent) - part of ComponentListener
- **hierarchyChanged** (HierarchyEvent) - part of HierarchyListener
- **mouseClicked** (MouseEvent) - part of MouseListener
- **mouseEntered** (MouseEvent) - part of MouseListener

- **mouseExited** (MouseEvent) - part of MouseListener
- **mousePressed** (MouseEvent) - part of MouseListener
- **mouseReleased** (MouseEvent) - part of MouseListener
- **mouseDragged** (MouseEvent) - part of MouseMotionListener
- **mouseMoved** (MouseEvent) - part of MouseMotionListener
- **propertyChange** (PropertyChangeEvent) - part of PropertyChangeListener
- **ancestorMoved** (HierarchyEvent) - part of HierarchyBoundsListener
- **ancestorResized** (HierarchyEvent) - part of HierarchyBoundsListener
- **focusGained** (FocusEvent) - part of FocusListener
- **focusLost** (FocusEvent) - part of FocusListener
- **mouseWheelMoved** (MouseEvent) - part of MouseWheelListener
- **caretPositionChanged** (InputMethodEvent) - part of InputMethodListener
- **inputMethodTextChanged** (InputMethodEvent) - part of InputMethodListener

Content

Usage

Examples

Observable Attributes

- UI
- alignmentX
- alignmentY
- background
- border
- component
- componentCount
- componentPopupMenu
- components
- containerListeners
- enabled
- focusCycleRoot
- focusTraversalKeys
- focusTraversalPolicy
- focusTraversalPolicyProvider
- focusTraversalPolicySet
- focusable
- font
- foreground
- icon
- inheritsPopupMenu
- initialSelectionValue
- initialValue
- inputValue
- inputVerifier
- insets
- layout
- maximumSize
- message
- messageType
- minimumSize
- opaque
- optionType
- options
- preferredSize
- selectionValues
- transferHandler
- value
- verifyInputWhenFocusTarget
- wantsInput

SwingBuilder.overlayLayout

This page last changed on Mar 21, 2008 by [shemnon](#).

- [Generated Object](#)
- [Attributes](#)
- [Events](#)
- [Content](#)
- [Usage](#)
- [Examples](#)

(Automatically generated from BeanInfo)

Generated Object

A `javax.swing.OverlayLayout` is returned, unless the user passes in a subclass of `OverlayLayout` as the value argument, in which case the value argument is returned.

Attributes

Events

Content

Usage

Examples

SwingBuilder.panel

This page last changed on Mar 21, 2008 by [shemnon](#).

- [Generated Object](#)
- [Attributes](#)
- [Events](#)
- [Content](#)
- [Usage](#)
- [Examples](#)
- [Observable Attributes](#)

(Automatically generated from BeanInfo)

Generated Object

A `javax.swing.JPanel` is returned, unless the user passes in a subclass of `JPanel` as the value argument, in which case the value argument is returned.

Attributes

Declared in `javax.swing.JPanel`

- **UI** <PanelUI> The UI object that implements the Component's LookAndFeel.

Declared in `javax.swing.JComponent`

- **autoscrolls** <boolean> Determines if this component automatically scrolls its contents when dragged.
- **border** <Border> The component's border.
- **componentPopupMenu** <JPopupMenu> Popup to show
- **debugGraphicsOptions** <int> Diagnostic options for graphics operations.
- **inheritsPopupMenu** <boolean> Whether or not the JPopupMenu is inherited
- **inputVerifier** <InputVerifier> The component's input verifier.
- **opaque** <boolean> The component's opacity
- **toolTipText** <String> The text to display in a tool tip.
- **transferHandler** <TransferHandler> Mechanism for transfer of data to and from the component
- **verifyInputWhenFocusTarget** <boolean> Whether the Component verifies input before accepting focus.

- **UIClassID** <String>
- **accessibleContext** <AccessibleContext>
- **actionMap** <ActionMap>
- **doubleBuffered** <boolean>
- **graphics** <Graphics>
- **height** <int>
- **managingFocus** <boolean>
- **nextFocusableComponent** <Component>
- **optimizedDrawingEnabled** <boolean>
- **paintingTile** <boolean>
- **registeredKeyStrokes** <KeyStroke[]>
- **requestFocusEnabled** <boolean>
- **rootPane** <JRootPane>
- **topLevelAncestor** <Container>
- **validateRoot** <boolean>
- **visibleRect** <Rectangle>
- **width** <int>
- **x** <int>
- **y** <int>

Declared in `java.awt.Container`

- **alignmentX** <float>

- **alignmentY** <float>
- **componentCount** <int>
- **components** <Component[]>
- **focusCycleRoot** <boolean>
- **focusTraversalPolicy** <FocusTraversalPolicy>
- **focusTraversalPolicyProvider** <boolean>
- **focusTraversalPolicySet** <boolean>
- **insets** <Insets>
- **layout** <LayoutManager>
- **maximumSize** <Dimension>
- **minimumSize** <Dimension>
- **preferredSize** <Dimension>

Declared in java.awt.Component

- **background** <Color>
- **enabled** <boolean>
- **focusable** <boolean>
- **font**
- **foreground** <Color>
- **name** <String>
- **visible** <boolean>

Events

Declared in javax.swing.JComponent

- **vetoableChange** (PropertyChangeEvent) - part of VetoableChangeListener
- **ancestorMoved** (AncestorEvent) - part of AncestorListener
- **ancestorAdded** (AncestorEvent) - part of AncestorListener
- **ancestorRemoved** (AncestorEvent) - part of AncestorListener

Declared in java.awt.Container

- **componentAdded** (ContainerEvent) - part of ContainerListener
- **componentRemoved** (ContainerEvent) - part of ContainerListener

Declared in java.awt.Component

- **keyPressed** (KeyEvent) - part of KeyListener
- **keyReleased** (KeyEvent) - part of KeyListener
- **keyTyped** (KeyEvent) - part of KeyListener
- **componentHidden** (ComponentEvent) - part of ComponentListener
- **componentMoved** (ComponentEvent) - part of ComponentListener
- **componentResized** (ComponentEvent) - part of ComponentListener
- **componentShown** (ComponentEvent) - part of ComponentListener
- **hierarchyChanged** (HierarchyEvent) - part of HierarchyListener
- **mouseClicked** (MouseEvent) - part of MouseListener
- **mouseEntered** (MouseEvent) - part of MouseListener
- **mouseExited** (MouseEvent) - part of MouseListener
- **mousePressed** (MouseEvent) - part of MouseListener
- **mouseReleased** (MouseEvent) - part of MouseListener
- **mouseDragged** (MouseEvent) - part of MouseMotionListener
- **mouseMoved** (MouseEvent) - part of MouseMotionListener
- **propertyChange** (PropertyChangeEvent) - part of PropertyChangeListener
- **ancestorMoved** (HierarchyEvent) - part of HierarchyBoundsListener
- **ancestorResized** (HierarchyEvent) - part of HierarchyBoundsListener
- **focusGained** (FocusEvent) - part of FocusListener
- **focusLost** (FocusEvent) - part of FocusListener
- **mouseWheelMoved** (MouseEvent) - part of MouseWheelListener
- **caretPositionChanged** (InputMethodEvent) - part of InputMethodListener
- **inputMethodTextChanged** (InputMethodEvent) - part of InputMethodListener

Content

Usage

Examples

Observable Attributes

- UI
- alignmentX
- alignmentY
- background
- border
- component
- componentCount
- componentPopupMenu
- components
- containerListeners
- enabled
- focusCycleRoot
- focusTraversalKeys
- focusTraversalPolicy
- focusTraversalPolicyProvider
- focusTraversalPolicySet
- focusable
- font
- foreground
- inheritsPopupMenu
- inputVerifier
- insets
- layout
- maximumSize
- minimumSize
- opaque
- preferredSize
- transferHandler
- verifyInputWhenFocusTarget

SwingBuilder.passwordField

This page last changed on Mar 21, 2008 by [shemnon](#).

- [Generated Object](#)
- [Attributes](#)
- [Events](#)
- [Content](#)
- [Usage](#)
- [Examples](#)
- [Observable Attributes](#)

(Automatically generated from BeanInfo)

Generated Object

A `javax.swing.JPasswordField` is returned, unless the user passes in a subclass of `JPasswordField` as the value argument, in which case the value argument is returned.

Attributes

Declared in `javax.swing.JPasswordField`

- **echoChar** <char> character to display in place of the real characters
- **password** <char[]>

Declared in `javax.swing.JTextField`

- **action** <Action> the Action instance connected with this ActionEvent source
- **columns** <int> the number of columns preferred for display
- **horizontalAlignment** <int> Set the field alignment to LEFT, CENTER, RIGHT, LEADING (the default) or TRAILING
- **horizontalVisibility** <BoundedRangeModel>
- **scrollOffset** <int>

Declared in `javax.swing.text.JTextComponent`

- **caret** <Caret> the caret used to select/navigate
- **caretColor** <Color> the color used to render the caret
- **caretPosition** <int> the caret position
- **disabledTextColor** <Color> color used to render disabled text
- **document** <Document> the text document model
- **dragEnabled** <boolean> determines whether automatic drag handling is enabled
- **editable** <boolean> specifies if the text can be edited
- **focusAccelerator** <char> accelerator character used to grab focus
- **highlighter** <Highlighter> object responsible for background highlights
- **keymap** <Keymap> set of key event to action bindings to use
- **margin** <Insets> desired space between the border and text area
- **selectedTextColor** <Color> color used to render selected text
- **selectionColor** <Color> color used to render selection background
- **selectionEnd** <int> ending location of the selection.
- **selectionStart** <int> starting location of the selection.
- **text** <String> the text of this component

- **UI** <TextUI>
- **inputMethodRequests** <InputMethodRequests>
- **navigationFilter** <NavigationFilter>
- **preferredScrollableViewportSize** <Dimension>
- **scrollableTracksViewportHeight** <boolean>
- **scrollableTracksViewportWidth** <boolean>
- **selectedText** <String>

Declared in javax.swing.JComponent

- **autoscrolls** <boolean> Determines if this component automatically scrolls its contents when dragged.
- **border** <Border> The component's border.
- **componentPopupMenu** <JPopupMenu> Popup to show
- **debugGraphicsOptions** <int> Diagnostic options for graphics operations.
- **inheritsPopupMenu** <boolean> Whether or not the JPopupMenu is inherited
- **inputVerifier** <InputVerifier> The component's input verifier.
- **opaque** <boolean> The component's opacity
- **toolTipText** <String> The text to display in a tool tip.
- **transferHandler** <TransferHandler> Mechanism for transfer of data to and from the component
- **verifyInputWhenFocusTarget** <boolean> Whether the Component verifies input before accepting focus.

- **UIClassID** <String>
- **accessibleContext** <AccessibleContext>
- **actionMap** <ActionMap>
- **doubleBuffered** <boolean>
- **graphics** <Graphics>
- **height** <int>
- **managingFocus** <boolean>
- **nextFocusableComponent** <Component>
- **optimizedDrawingEnabled** <boolean>
- **paintingTile** <boolean>
- **registeredKeyStrokes** <KeyStroke[]>
- **requestFocusEnabled** <boolean>
- **rootPane** <JRootPane>
- **topLevelAncestor** <Container>
- **validateRoot** <boolean>
- **visibleRect** <Rectangle>
- **width** <int>
- **x** <int>
- **y** <int>

Declared in java.awt.Container

- **alignmentX** <float>
- **alignmentY** <float>
- **componentCount** <int>
- **components** <Component[]>
- **focusCycleRoot** <boolean>
- **focusTraversalPolicy** <FocusTraversalPolicy>
- **focusTraversalPolicyProvider** <boolean>
- **focusTraversalPolicySet** <boolean>
- **insets** <Insets>
- **layout** <LayoutManager>
- **maximumSize** <Dimension>
- **minimumSize** <Dimension>
- **preferredSize** <Dimension>

Declared in java.awt.Component

- **background** <Color>
- **enabled** <boolean>
- **focusable** <boolean>
- **font**
- **foreground** <Color>
- **name** <String>
- **visible** <boolean>

Events

Declared in `javax.swing.JTextField`

- **actionPerformed** (ActionEvent) - part of ActionListener

Declared in `javax.swing.text.JTextComponent`

- **caretUpdate** (CaretEvent) - part of CaretListener

Declared in `javax.swing.JComponent`

- **vetoableChange** (PropertyChangeEvent) - part of VetoableChangeListener
- **ancestorMoved** (AncestorEvent) - part of AncestorListener
- **ancestorAdded** (AncestorEvent) - part of AncestorListener
- **ancestorRemoved** (AncestorEvent) - part of AncestorListener

Declared in `java.awt.Container`

- **componentAdded** (ContainerEvent) - part of ContainerListener
- **componentRemoved** (ContainerEvent) - part of ContainerListener

Declared in `java.awt.Component`

- **keyPressed** (KeyEvent) - part of KeyListener
- **keyReleased** (KeyEvent) - part of KeyListener
- **keyTyped** (KeyEvent) - part of KeyListener
- **componentHidden** (ComponentEvent) - part of ComponentListener
- **componentMoved** (ComponentEvent) - part of ComponentListener
- **componentResized** (ComponentEvent) - part of ComponentListener
- **componentShown** (ComponentEvent) - part of ComponentListener
- **hierarchyChanged** (HierarchyEvent) - part of HierarchyListener
- **mouseClicked** (MouseEvent) - part of MouseListener
- **mouseEntered** (MouseEvent) - part of MouseListener
- **mouseExited** (MouseEvent) - part of MouseListener
- **mousePressed** (MouseEvent) - part of MouseListener
- **mouseReleased** (MouseEvent) - part of MouseListener
- **mouseDragged** (MouseEvent) - part of MouseMotionListener
- **mouseMoved** (MouseEvent) - part of MouseMotionListener
- **propertyChange** (PropertyChangeEvent) - part of PropertyChangeListener
- **ancestorMoved** (HierarchyEvent) - part of HierarchyBoundsListener
- **ancestorResized** (HierarchyEvent) - part of HierarchyBoundsListener
- **focusGained** (FocusEvent) - part of FocusListener
- **focusLost** (FocusEvent) - part of FocusListener
- **mouseWheelMoved** (MouseEvent) - part of MouseWheelListener
- **caretPositionChanged** (InputMethodEvent) - part of InputMethodListener
- **inputMethodTextChanged** (InputMethodEvent) - part of InputMethodListener

Content

Usage

Examples

Observable Attributes

- action
- alignmentX
- alignmentY
- background

- border
- caret
- caretColor
- component
- componentCount
- componentPopupMenu
- components
- containerListeners
- disabledTextColor
- document
- editable
- enabled
- focusAccelerator
- focusCycleRoot
- focusTraversalKeys
- focusTraversalPolicy
- focusTraversalPolicyProvider
- focusTraversalPolicySet
- focusable
- font
- foreground
- highlighter
- horizontalAlignment
- inheritsPopupMenu
- inputVerifier
- insets
- keymap
- layout
- margin
- maximumSize
- minimumSize
- opaque
- preferredSize
- selectedTextColor
- selectionColor
- transferHandler
- verifyInputWhenFocusTarget

SwingBuilder.popupMenu

This page last changed on Mar 21, 2008 by [shemnon](#).

- [Generated Object](#)
- [Attributes](#)
- [Events](#)
- [Content](#)
- [Usage](#)
- [Examples](#)
- [Observable Attributes](#)

(Automatically generated from BeanInfo)

Generated Object

A `javax.swing.JPopupMenu` is returned, unless the user passes in a subclass of `JPopupMenu` as the value argument, in which case the value argument is returned.

Attributes

Declared in `javax.swing.JPopupMenu`

- **UI** <PopupMenuUI> The UI object that implements the Component's LookAndFeel.
- **borderPainted** <boolean> Is the border of the popup menu painted
- **invoker** <Component> The invoking component for the popup menu
- **label** <String> The label for the popup menu.
- **lightWeightPopupEnabled** <boolean> Determines whether lightweight popups are used when possible
- **selectionModel** <SingleSelectionModel> The selection model for the popup menu

- **margin** <Insets>
- **subElements** <MenuElement[]>

Declared in `javax.swing.JComponent`

- **autoscrolls** <boolean> Determines if this component automatically scrolls its contents when dragged.
- **border** <Border> The component's border.
- **componentPopupMenu** <JPopupMenu> Popup to show
- **debugGraphicsOptions** <int> Diagnostic options for graphics operations.
- **inheritsPopupMenu** <boolean> Whether or not the JPopupMenu is inherited
- **inputVerifier** <InputVerifier> The component's input verifier.
- **opaque** <boolean> The component's opacity
- **toolTipText** <String> The text to display in a tool tip.
- **transferHandler** <TransferHandler> Mechanism for transfer of data to and from the component
- **verifyInputWhenFocusTarget** <boolean> Whether the Component verifies input before accepting focus.

- **UIClassID** <String>
- **accessibleContext** <AccessibleContext>
- **actionMap** <ActionMap>
- **doubleBuffered** <boolean>
- **graphics** <Graphics>
- **height** <int>
- **managingFocus** <boolean>
- **nextFocusableComponent** <Component>
- **optimizedDrawingEnabled** <boolean>
- **paintingTile** <boolean>
- **registeredKeyStrokes** <KeyStroke[]>
- **requestFocusEnabled** <boolean>
- **rootPane** <JRootPane>
- **topLevelAncestor** <Container>
- **validateRoot** <boolean>

- **visibleRect** <Rectangle>
- **width** <int>
- **x** <int>
- **y** <int>

Declared in java.awt.Container

- **alignmentX** <float>
- **alignmentY** <float>
- **componentCount** <int>
- **components** <Component[]>
- **focusCycleRoot** <boolean>
- **focusTraversalPolicy** <FocusTraversalPolicy>
- **focusTraversalPolicyProvider** <boolean>
- **focusTraversalPolicySet** <boolean>
- **insets** <Insets>
- **layout** <LayoutManager>
- **maximumSize** <Dimension>
- **minimumSize** <Dimension>
- **preferredSize** <Dimension>

Declared in java.awt.Component

- **background** <Color>
- **enabled** <boolean>
- **focusable** <boolean>
- **font**
- **foreground** <Color>
- **name** <String>
- **visible** <boolean>

Events

Declared in javax.swing.JPopupMenu

- **menuKeyPressed** (MenuKeyEvent) - part of MenuKeyListener
- **menuKeyReleased** (MenuKeyEvent) - part of MenuKeyListener
- **menuKeyTyped** (MenuKeyEvent) - part of MenuKeyListener
- **popupMenuCanceled** (PopupMenuEvent) - part of PopupMenuListener
- **popupMenuWillBecomeInvisible** (PopupMenuEvent) - part of PopupMenuListener
- **popupMenuWillBecomeVisible** (PopupMenuEvent) - part of PopupMenuListener

Declared in javax.swing.JComponent

- **vetoableChange** (PropertyChangeEvent) - part of VetoableChangeListener
- **ancestorMoved** (AncestorEvent) - part of AncestorListener
- **ancestorAdded** (AncestorEvent) - part of AncestorListener
- **ancestorRemoved** (AncestorEvent) - part of AncestorListener

Declared in java.awt.Container

- **componentAdded** (ContainerEvent) - part of ContainerListener
- **componentRemoved** (ContainerEvent) - part of ContainerListener

Declared in java.awt.Component

- **keyPressed** (KeyEvent) - part of KeyListener
- **keyReleased** (KeyEvent) - part of KeyListener
- **keyTyped** (KeyEvent) - part of KeyListener
- **componentHidden** (ComponentEvent) - part of ComponentListener
- **componentMoved** (ComponentEvent) - part of ComponentListener
- **componentResized** (ComponentEvent) - part of ComponentListener

- **componentShown** (ComponentEvent) - part of ComponentListener
- **hierarchyChanged** (HierarchyEvent) - part of HierarchyListener
- **mouseClicked** (MouseEvent) - part of MouseListener
- **mouseEntered** (MouseEvent) - part of MouseListener
- **mouseExited** (MouseEvent) - part of MouseListener
- **mousePressed** (MouseEvent) - part of MouseListener
- **mouseReleased** (MouseEvent) - part of MouseListener
- **mouseDragged** (MouseEvent) - part of MouseMotionListener
- **mouseMoved** (MouseEvent) - part of MouseMotionListener
- **propertyChange** (PropertyChangeEvent) - part of PropertyChangeListener
- **ancestorMoved** (HierarchyEvent) - part of HierarchyBoundsListener
- **ancestorResized** (HierarchyEvent) - part of HierarchyBoundsListener
- **focusGained** (FocusEvent) - part of FocusListener
- **focusLost** (FocusEvent) - part of FocusListener
- **mouseWheelMoved** (MouseEvent) - part of MouseWheelListener
- **caretPositionChanged** (InputMethodEvent) - part of InputMethodListener
- **inputMethodTextChanged** (InputMethodEvent) - part of InputMethodListener

Content

Usage

Examples

Observable Attributes

- UI
- alignmentX
- alignmentY
- background
- border
- componentCount
- componentPopupMenu
- components
- containerListeners
- enabled
- focusCycleRoot
- focusTraversalKeys
- focusTraversalPolicy
- focusTraversalPolicyProvider
- focusTraversalPolicySet
- focusable
- font
- foreground
- inheritsPopupMenu
- inputVerifier
- insets
- label
- layout
- maximumSize
- minimumSize
- opaque
- preferredSize
- transferHandler
- verifyInputWhenFocusTarget
- visible

SwingBuilder.progressBar

This page last changed on Mar 21, 2008 by [shemnon](#).

- [Generated Object](#)
- [Attributes](#)
- [Events](#)
- [Content](#)
- [Usage](#)
- [Examples](#)
- [Observable Attributes](#)

(Automatically generated from BeanInfo)

Generated Object

A `javax.swing.JProgressBar` is returned, unless the user passes in a subclass of `JProgressBar` as the value argument, in which case the value argument is returned.

Attributes

Declared in `javax.swing.JProgressBar`

- **UI** <ProgressBarUI> The UI object that implements the Component's LookAndFeel.
- **borderPainted** <boolean> Whether the progress bar should paint its border.
- **indeterminate** <boolean> Is the progress bar indeterminate (true) or normal (false)?
- **maximum** <int> The progress bar's maximum value.
- **minimum** <int> The progress bar's minimum value.
- **model** <BoundedRangeModel> The data model used by the JProgressBar.
- **orientation** <int> Set the progress bar's orientation.
- **string** <String> Specifies the progress string to paint
- **stringPainted** <boolean> Whether the progress bar should render a string.
- **value** <int> The progress bar's current value.

- **percentComplete** <double>

Declared in `javax.swing.JComponent`

- **autoscrolls** <boolean> Determines if this component automatically scrolls its contents when dragged.
- **border** <Border> The component's border.
- **componentPopupMenu** <JPopupMenu> Popup to show
- **debugGraphicsOptions** <int> Diagnostic options for graphics operations.
- **inheritsPopupMenu** <boolean> Whether or not the JPopupMenu is inherited
- **inputVerifier** <InputVerifier> The component's input verifier.
- **opaque** <boolean> The component's opacity
- **toolTipText** <String> The text to display in a tool tip.
- **transferHandler** <TransferHandler> Mechanism for transfer of data to and from the component
- **verifyInputWhenFocusTarget** <boolean> Whether the Component verifies input before accepting focus.

- **UIClassID** <String>
- **accessibleContext** <AccessibleContext>
- **actionMap** <ActionMap>
- **doubleBuffered** <boolean>
- **graphics** <Graphics>
- **height** <int>
- **managingFocus** <boolean>
- **nextFocusableComponent** <Component>
- **optimizedDrawingEnabled** <boolean>
- **paintingTile** <boolean>
- **registeredKeyStrokes** <KeyStroke[]>
- **requestFocusEnabled** <boolean>

- **rootPane** <JRootPane>
- **topLevelAncestor** <Container>
- **validateRoot** <boolean>
- **visibleRect** <Rectangle>
- **width** <int>
- **x** <int>
- **y** <int>

Declared in **java.awt.Container**

- **alignmentX** <float>
- **alignmentY** <float>
- **componentCount** <int>
- **components** <Component[]>
- **focusCycleRoot** <boolean>
- **focusTraversalPolicy** <FocusTraversalPolicy>
- **focusTraversalPolicyProvider** <boolean>
- **focusTraversalPolicySet** <boolean>
- **insets** <Insets>
- **layout** <LayoutManager>
- **maximumSize** <Dimension>
- **minimumSize** <Dimension>
- **preferredSize** <Dimension>

Declared in **java.awt.Component**

- **background** <Color>
- **enabled** <boolean>
- **focusable** <boolean>
- **font**
- **foreground** <Color>
- **name** <String>
- **visible** <boolean>

Events

Declared in **javax.swing.JProgressBar**

- **stateChanged** (ChangeEvent) - part of ChangeListener

Declared in **javax.swing.JComponent**

- **vetoableChange** (PropertyChangeEvent) - part of VetoableChangeListener
- **ancestorMoved** (AncestorEvent) - part of AncestorListener
- **ancestorAdded** (AncestorEvent) - part of AncestorListener
- **ancestorRemoved** (AncestorEvent) - part of AncestorListener

Declared in **java.awt.Container**

- **componentAdded** (ContainerEvent) - part of ContainerListener
- **componentRemoved** (ContainerEvent) - part of ContainerListener

Declared in **java.awt.Component**

- **keyPressed** (KeyEvent) - part of KeyListener
- **keyReleased** (KeyEvent) - part of KeyListener
- **keyTyped** (KeyEvent) - part of KeyListener
- **componentHidden** (ComponentEvent) - part of ComponentListener
- **componentMoved** (ComponentEvent) - part of ComponentListener
- **componentResized** (ComponentEvent) - part of ComponentListener
- **componentShown** (ComponentEvent) - part of ComponentListener
- **hierarchyChanged** (HierarchyEvent) - part of HierarchyListener

- **mouseClicked** (MouseEvent) - part of MouseListener
- **mouseEntered** (MouseEvent) - part of MouseListener
- **mouseExited** (MouseEvent) - part of MouseListener
- **mousePressed** (MouseEvent) - part of MouseListener
- **mouseReleased** (MouseEvent) - part of MouseListener
- **mouseDragged** (MouseEvent) - part of MouseMotionListener
- **mouseMoved** (MouseEvent) - part of MouseMotionListener
- **propertyChange** (PropertyChangeEvent) - part of PropertyChangeListener
- **ancestorMoved** (HierarchyEvent) - part of HierarchyBoundsListener
- **ancestorResized** (HierarchyEvent) - part of HierarchyBoundsListener
- **focusGained** (FocusEvent) - part of FocusListener
- **focusLost** (FocusEvent) - part of FocusListener
- **mouseWheelMoved** (MouseEvent) - part of MouseWheelListener
- **caretPositionChanged** (InputMethodEvent) - part of InputMethodListener
- **inputMethodTextChanged** (InputMethodEvent) - part of InputMethodListener

Content

Usage

Examples

Observable Attributes

- UI
- alignmentX
- alignmentY
- background
- border
- borderPainted
- component
- componentCount
- componentPopupMenu
- components
- containerListeners
- enabled
- focusCycleRoot
- focusTraversalKeys
- focusTraversalPolicy
- focusTraversalPolicyProvider
- focusTraversalPolicySet
- focusable
- font
- foreground
- inheritsPopupMenu
- inputVerifier
- insets
- layout
- maximumSize
- minimumSize
- opaque
- orientation
- preferredSize
- string
- stringPainted
- transferHandler
- verifyInputWhenFocusTarget

SwingBuilder.propertyColumn

This page last changed on Mar 21, 2008 by [shemnon](#).

- [Generated Object](#)
- [Attributes](#)
- [Events](#)
- [Content](#)
- [Usage](#)
- [Examples](#)
- [Observable Attributes](#)

(Automatically generated from BeanInfo)

Generated Object

A `groovy.model.DefaultTableColumn` is returned, unless the user passes in a subclass of `DefaultTableColumn` as the value argument, in which case the value argument is returned.

Attributes

Declared in `groovy.model.DefaultTableColumn`

- **type** <Class>
- **valueModel** <ValueModel>

Declared in `javax.swing.table.TableColumn`

- **cellEditor** <TableCellEditor>
- **cellRenderer** <TableCellRenderer>
- **headerRenderer** <TableCellRenderer>
- **headerValue** <Object>
- **identifier** <Object>
- **maxWidth** <int>
- **minWidth** <int>
- **modelIndex** <int>
- **preferredWidth** <int>
- **resizable** <boolean>
- **width** <int>

Events

Declared in `javax.swing.table.TableColumn`

- **propertyChange** (PropertyChangeEvent) - part of PropertyChangeListener

Content

Usage

Examples

Observable Attributes

- cellEditor
- cellRenderer
- headerRenderer
- headerValue
- identifier
- maxWidth

- minWidth
- modelIndex
- preferredWidth
- propertyChangeListeners
- resizable
- type
- valueModel
- width

SwingBuilder.radioButton

This page last changed on Mar 21, 2008 by [shemnon](#).

- [Generated Object](#)
- [Attributes](#)
- [Events](#)
- [Content](#)
- [Usage](#)
- [Examples](#)
- [Observable Attributes](#)

(Automatically generated from BeanInfo)

Generated Object

A `javax.swing.JRadioButton` is returned, unless the user passes in a subclass of `JRadioButton` as the value argument, in which case the value argument is returned.

Attributes

Declared in `javax.swing.AbstractButton`

- **UI** `<ButtonUI>` The UI object that implements the LookAndFeel.
- **action** `<Action>` the Action instance connected with this ActionEvent source
- **borderPainted** `<boolean>` Whether the border should be painted.
- **contentAreaFilled** `<boolean>` Whether the button should paint the content area or leave it transparent.
- **disabledIcon** `<Icon>` The disabled icon for the button.
- **disabledSelectedIcon** `<Icon>` The disabled selection icon for the button.
- **displayedMnemonicIndex** `<int>` the index into the String to draw the keyboard character mnemonic at
- **focusPainted** `<boolean>` Whether focus should be painted
- **horizontalAlignment** `<int>` The horizontal alignment of the icon and text.
- **horizontalTextPosition** `<int>` The horizontal position of the text relative to the icon.
- **icon** `<Icon>` The button's default icon
- **iconTextGap** `<int>` If both the icon and text properties are set, this property defines the space between them.
- **label** `<String>` Replace by `setText(text)`
- **margin** `<Insets>` The space between the button's border and the label.
- **mnemonic** `<int>` the keyboard character mnemonic
- **model** `<ButtonModel>` Model that the Button uses.
- **pressedIcon** `<Icon>` The pressed icon for the button.
- **rolloverEnabled** `<boolean>` Whether rollover effects should be enabled.
- **rolloverIcon** `<Icon>` The rollover icon for the button.
- **rolloverSelectedIcon** `<Icon>` The rollover selected icon for the button.
- **selectedIcon** `<Icon>` The selected icon for the button.
- **text** `<String>` The button's text.
- **verticalAlignment** `<int>` The vertical alignment of the icon and text.
- **verticalTextPosition** `<int>` The vertical position of the text relative to the icon.

- **actionCommand** `<String>`
- **multiClickThreshold** `<long>`
- **selected** `<boolean>`
- **selectedObjects** `<Object[]>`

Declared in `javax.swing.JComponent`

- **autoscrolls** `<boolean>` Determines if this component automatically scrolls its contents when dragged.
- **border** `<Border>` The component's border.
- **componentPopupMenu** `<JPopupMenu>` Popup to show
- **debugGraphicsOptions** `<int>` Diagnostic options for graphics operations.

- **inheritsPopupMenu** <boolean> Whether or not the JPopupMenu is inherited
- **inputVerifier** <InputVerifier> The component's input verifier.
- **opaque** <boolean> The component's opacity
- **toolTipText** <String> The text to display in a tool tip.
- **transferHandler** <TransferHandler> Mechanism for transfer of data to and from the component
- **verifyInputWhenFocusTarget** <boolean> Whether the Component verifies input before accepting focus.
- **UIClassID** <String>
- **accessibleContext** <AccessibleContext>
- **actionMap** <ActionMap>
- **doubleBuffered** <boolean>
- **graphics** <Graphics>
- **height** <int>
- **managingFocus** <boolean>
- **nextFocusableComponent** <Component>
- **optimizedDrawingEnabled** <boolean>
- **paintingTile** <boolean>
- **registeredKeyStrokes** <KeyStroke[]>
- **requestFocusEnabled** <boolean>
- **rootPane** <JRootPane>
- **topLevelAncestor** <Container>
- **validateRoot** <boolean>
- **visibleRect** <Rectangle>
- **width** <int>
- **x** <int>
- **y** <int>

Declared in java.awt.Container

- **alignmentX** <float>
- **alignmentY** <float>
- **componentCount** <int>
- **components** <Component[]>
- **focusCycleRoot** <boolean>
- **focusTraversalPolicy** <FocusTraversalPolicy>
- **focusTraversalPolicyProvider** <boolean>
- **focusTraversalPolicySet** <boolean>
- **insets** <Insets>
- **layout** <LayoutManager>
- **maximumSize** <Dimension>
- **minimumSize** <Dimension>
- **preferredSize** <Dimension>

Declared in java.awt.Component

- **background** <Color>
- **enabled** <boolean>
- **focusable** <boolean>
- **font**
- **foreground** <Color>
- **name** <String>
- **visible** <boolean>

Events

Declared in javax.swing.AbstractButton

- **itemStateChanged** (ItemEvent) - part of ItemListener
- **actionPerformed** (ActionEvent) - part of ActionListener
- **stateChanged** (ChangeEvent) - part of ChangeListener

Declared in javax.swing.JComponent

- **vetoableChange** (PropertyChangeEvent) - part of VetoableChangeListener
- **ancestorMoved** (AncestorEvent) - part of AncestorListener
- **ancestorAdded** (AncestorEvent) - part of AncestorListener
- **ancestorRemoved** (AncestorEvent) - part of AncestorListener

Declared in java.awt.Container

- **componentAdded** (ContainerEvent) - part of ContainerListener
- **componentRemoved** (ContainerEvent) - part of ContainerListener

Declared in java.awt.Component

- **keyPressed** (KeyEvent) - part of KeyListener
- **keyReleased** (KeyEvent) - part of KeyListener
- **keyTyped** (KeyEvent) - part of KeyListener
- **componentHidden** (ComponentEvent) - part of ComponentListener
- **componentMoved** (ComponentEvent) - part of ComponentListener
- **componentResized** (ComponentEvent) - part of ComponentListener
- **componentShown** (ComponentEvent) - part of ComponentListener
- **hierarchyChanged** (HierarchyEvent) - part of HierarchyListener
- **mouseClicked** (MouseEvent) - part of MouseListener
- **mouseEntered** (MouseEvent) - part of MouseListener
- **mouseExited** (MouseEvent) - part of MouseListener
- **mousePressed** (MouseEvent) - part of MouseListener
- **mouseReleased** (MouseEvent) - part of MouseListener
- **mouseDragged** (MouseEvent) - part of MouseMotionListener
- **mouseMoved** (MouseEvent) - part of MouseMotionListener
- **propertyChange** (PropertyChangeEvent) - part of PropertyChangeListener
- **ancestorMoved** (HierarchyEvent) - part of HierarchyBoundsListener
- **ancestorResized** (HierarchyEvent) - part of HierarchyBoundsListener
- **focusGained** (FocusEvent) - part of FocusListener
- **focusLost** (FocusEvent) - part of FocusListener
- **mouseWheelMoved** (MouseEvent) - part of MouseWheelListener
- **caretPositionChanged** (InputMethodEvent) - part of InputMethodListener
- **inputMethodTextChanged** (InputMethodEvent) - part of InputMethodListener

Content

Usage

Examples

Observable Attributes

- UI
- action
- alignmentX
- alignmentY
- background
- border
- borderPainted
- component
- componentCount
- componentPopupMenu
- components
- containerListeners
- contentAreaFilled
- disabledIcon
- disabledSelectedIcon

- displayedMnemonicIndex
- enabled
- focusCycleRoot
- focusPainted
- focusTraversalKeys
- focusTraversalPolicy
- focusTraversalPolicyProvider
- focusTraversalPolicySet
- focusable
- font
- foreground
- horizontalAlignment
- horizontalTextPosition
- icon
- iconTextGap
- inheritsPopupMenu
- inputVerifier
- insets
- label
- layout
- margin
- maximumSize
- minimumSize
- mnemonic
- model
- opaque
- preferredSize
- pressedIcon
- rolloverEnabled
- rolloverIcon
- rolloverSelectedIcon
- selectedIcon
- text
- transferHandler
- verifyInputWhenFocusTarget
- verticalAlignment
- verticalTextPosition

SwingBuilder.radioButtonMenuItem

This page last changed on Mar 21, 2008 by [shemnon](#).

- [Generated Object](#)
- [Attributes](#)
- [Events](#)
- [Content](#)
- [Usage](#)
- [Examples](#)
- [Observable Attributes](#)

(Automatically generated from BeanInfo)

Generated Object

A `javax.swing.JRadioButtonMenuItem` is returned, unless the user passes in a subclass of `JRadioButtonMenuItem` as the value argument, in which case the value argument is returned.

Attributes

Declared in `javax.swing.JMenuItem`

- **accelerator** <KeyStroke> The keystroke combination which will invoke the `JMenuItem`'s actionlisteners without navigating the menu hierarchy
- **armed** <boolean> Mouse release will fire an action event
- **subElements** <MenuElement[]>

Declared in `javax.swing.AbstractButton`

- **UI** <ButtonUI> The UI object that implements the LookAndFeel.
- **action** <Action> the Action instance connected with this ActionEvent source
- **borderPainted** <boolean> Whether the border should be painted.
- **contentAreaFilled** <boolean> Whether the button should paint the content area or leave it transparent.
- **disabledIcon** <Icon> The disabled icon for the button.
- **disabledSelectedIcon** <Icon> The disabled selection icon for the button.
- **displayedMnemonicIndex** <int> the index into the String to draw the keyboard character mnemonic at
- **focusPainted** <boolean> Whether focus should be painted
- **horizontalAlignment** <int> The horizontal alignment of the icon and text.
- **horizontalTextPosition** <int> The horizontal position of the text relative to the icon.
- **icon** <Icon> The button's default icon
- **iconTextGap** <int> If both the icon and text properties are set, this property defines the space between them.
- **label** <String> Replace by `setText(text)`
- **margin** <Insets> The space between the button's border and the label.
- **mnemonic** <int> the keyboard character mnemonic
- **model** <ButtonModel> Model that the Button uses.
- **pressedIcon** <Icon> The pressed icon for the button.
- **rolloverEnabled** <boolean> Whether rollover effects should be enabled.
- **rolloverIcon** <Icon> The rollover icon for the button.
- **rolloverSelectedIcon** <Icon> The rollover selected icon for the button.
- **selectedIcon** <Icon> The selected icon for the button.
- **text** <String> The button's text.
- **verticalAlignment** <int> The vertical alignment of the icon and text.
- **verticalTextPosition** <int> The vertical position of the text relative to the icon.

- **actionCommand** <String>
- **multiClickThreshold** <long>
- **selected** <boolean>
- **selectedObjects** <Object[]>

Declared in javax.swing.JComponent

- **autoscrolls** <boolean> Determines if this component automatically scrolls its contents when dragged.
- **border** <Border> The component's border.
- **componentPopupMenu** <JPopupMenu> Popup to show
- **debugGraphicsOptions** <int> Diagnostic options for graphics operations.
- **inheritsPopupMenu** <boolean> Whether or not the JPopupMenu is inherited
- **inputVerifier** <InputVerifier> The component's input verifier.
- **opaque** <boolean> The component's opacity
- **toolTipText** <String> The text to display in a tool tip.
- **transferHandler** <TransferHandler> Mechanism for transfer of data to and from the component
- **verifyInputWhenFocusTarget** <boolean> Whether the Component verifies input before accepting focus.

- **UIClassID** <String>
- **accessibleContext** <AccessibleContext>
- **actionMap** <ActionMap>
- **doubleBuffered** <boolean>
- **graphics** <Graphics>
- **height** <int>
- **managingFocus** <boolean>
- **nextFocusableComponent** <Component>
- **optimizedDrawingEnabled** <boolean>
- **paintingTile** <boolean>
- **registeredKeyStrokes** <KeyStroke[]>
- **requestFocusEnabled** <boolean>
- **rootPane** <JRootPane>
- **topLevelAncestor** <Container>
- **validateRoot** <boolean>
- **visibleRect** <Rectangle>
- **width** <int>
- **x** <int>
- **y** <int>

Declared in java.awt.Container

- **alignmentX** <float>
- **alignmentY** <float>
- **componentCount** <int>
- **components** <Component[]>
- **focusCycleRoot** <boolean>
- **focusTraversalPolicy** <FocusTraversalPolicy>
- **focusTraversalPolicyProvider** <boolean>
- **focusTraversalPolicySet** <boolean>
- **insets** <Insets>
- **layout** <LayoutManager>
- **maximumSize** <Dimension>
- **minimumSize** <Dimension>
- **preferredSize** <Dimension>

Declared in java.awt.Component

- **background** <Color>
- **enabled** <boolean>
- **focusable** <boolean>
- **font**
- **foreground** <Color>
- **name** <String>
- **visible** <boolean>

Events

Declared in javax.swing.JMenuItem

- **menuKeyPressed** (MenuKeyEvent) - part of MenuKeyListener
- **menuKeyReleased** (MenuKeyEvent) - part of MenuKeyListener
- **menuKeyTyped** (MenuKeyEvent) - part of MenuKeyListener
- **menuDragMouseDragged** (MenuDragMouseEvent) - part of MenuDragMouseListener
- **menuDragMouseEntered** (MenuDragMouseEvent) - part of MenuDragMouseListener
- **menuDragMouseExited** (MenuDragMouseEvent) - part of MenuDragMouseListener
- **menuDragMouseReleased** (MenuDragMouseEvent) - part of MenuDragMouseListener

Declared in javax.swing.AbstractButton

- **itemStateChanged** (ItemEvent) - part of ItemListener
- **actionPerformed** (ActionEvent) - part of ActionListener
- **stateChanged** (ChangeEvent) - part of ChangeListener

Declared in javax.swing.JComponent

- **vetoableChange** (PropertyChangeEvent) - part of VetoableChangeListener
- **ancestorMoved** (AncestorEvent) - part of AncestorListener
- **ancestorAdded** (AncestorEvent) - part of AncestorListener
- **ancestorRemoved** (AncestorEvent) - part of AncestorListener

Declared in java.awt.Container

- **componentAdded** (ContainerEvent) - part of ContainerListener
- **componentRemoved** (ContainerEvent) - part of ContainerListener

Declared in java.awt.Component

- **keyPressed** (KeyEvent) - part of KeyListener
- **keyReleased** (KeyEvent) - part of KeyListener
- **keyTyped** (KeyEvent) - part of KeyListener
- **componentHidden** (ComponentEvent) - part of ComponentListener
- **componentMoved** (ComponentEvent) - part of ComponentListener
- **componentResized** (ComponentEvent) - part of ComponentListener
- **componentShown** (ComponentEvent) - part of ComponentListener
- **hierarchyChanged** (HierarchyEvent) - part of HierarchyListener
- **mouseClicked** (MouseEvent) - part of MouseListener
- **mouseEntered** (MouseEvent) - part of MouseListener
- **mouseExited** (MouseEvent) - part of MouseListener
- **mousePressed** (MouseEvent) - part of MouseListener
- **mouseReleased** (MouseEvent) - part of MouseListener
- **mouseDragged** (MouseEvent) - part of MouseMotionListener
- **mouseMoved** (MouseEvent) - part of MouseMotionListener
- **propertyChange** (PropertyChangeEvent) - part of PropertyChangeListener
- **ancestorMoved** (HierarchyEvent) - part of HierarchyBoundsListener
- **ancestorResized** (HierarchyEvent) - part of HierarchyBoundsListener
- **focusGained** (FocusEvent) - part of FocusListener
- **focusLost** (FocusEvent) - part of FocusListener
- **mouseWheelMoved** (MouseWheelEvent) - part of MouseWheelListener
- **caretPositionChanged** (InputMethodEvent) - part of InputMethodListener
- **inputMethodTextChanged** (InputMethodEvent) - part of InputMethodListener

Content

Usage

Examples

Observable Attributes

- UI
- accelerator
- action
- alignmentX
- alignmentY
- background
- border
- borderPainted
- componentCount
- componentPopupMenu
- components
- containerListeners
- contentAreaFilled
- disabledIcon
- disabledSelectedIcon
- displayedMnemonicIndex
- enabled
- focusCycleRoot
- focusPainted
- focusTraversalKeys
- focusTraversalPolicy
- focusTraversalPolicyProvider
- focusTraversalPolicySet
- focusable
- font
- foreground
- horizontalAlignment
- horizontalTextPosition
- icon
- iconTextGap
- inheritsPopupMenu
- inputVerifier
- insets
- label
- layout
- margin
- maximumSize
- minimumSize
- mnemonic
- model
- opaque
- preferredSize
- pressedIcon
- rolloverEnabled
- rolloverIcon
- rolloverSelectedIcon
- selectedIcon
- text
- transferHandler
- verifyInputWhenFocusTarget
- verticalAlignment
- verticalTextPosition

SwingBuilder.raisedBevelBorder

This page last changed on Oct 25, 2007 by [shemnon](#).

Generated Object

A `javax.swing.border.BevelBorder` with type `BevelBorder.RAISED`, a border that looks recessed into the panel.

Value Argument

`raisedBevelBorder()` takes no value arguments.

Attributes

If either `shadow:` or `highlight:` are specified, both must be specified.

If any of `shadowInner:`, `shadowOuter:`, `highlightInner:`, or `highlightOuter` are specified, all must be specified.

The attributes `shadow:` and `highlight:` are mutually exclusive to `shadowInner:`, `shadowOuter:`, `highlightInner:`, and `highlightOuter:`.

- **highlight** <Color> The color that is to be painted on the highlight side of the bevel.
- **shadow** <Color> The color that is to be painted on the shadow side of the bevel.
- **highlightInner** <Color> The inner color that is to be painted on the highlight side of the bevel.
- **highlightOuter** <Color> The outer color that is to be painted on the highlight side of the bevel.
- **shadowInner** <Color> The inner color that is to be painted on the shadow side of the bevel.
- **shadowOuter** <Color> The outer color that is to be painted on the shadow side of the bevel.
- **parent** <boolean> Whether or not this border is to be added to the parent `JComponent`.

Content

`raisedBevelBorder()` is a leaf node, no child content is allowed.

Examples

```
panel(border:raisedBevelBorder())
```

```
panel {
  raisedBevelBorder(shadow:Color.RED, highlight:Color.PINK, parent:true)
}
```

```
raisedBevelBorder(
  shadowOuter:Color.BLACK, shadowInner:Color.GREY,
  highlightOuter:Color.RED, highlightInner:Color.PINK)
```

SwingBuilder.raisedEtchedBorder

This page last changed on Oct 26, 2007 by [shemnon](#).

Generated Object

A javax.swing.border.EtchedBorder with type of EtchedBorder.RAISED, a border that looks like a groove has been raised out of the panel.

Value Argument

raisedEtchedBorder() takes no value arguments.

Attributes

If any of shadow: or highlight: are specified, all must be specified.

- **highlight** <Color> The color that is to be painted on the highlight side of the raised etch.
- **shadow** <Color> The color that is to be painted on the shadow side of the raised etch.
- **parent** <boolean> Whether or not this border is to be added to the parent JComponent.

Content

raisedEtchedBorder() is a leaf node, no child content is allowed.

Examples

```
panel(border:raisedEtchedBorder())
```

```
panel {  
  raisedEtchedBorder(shadow:Color.RED, highlight:Color.PINK, parent:true)  
}
```

SwingBuilder.scrollBar

This page last changed on Mar 21, 2008 by [shemnon](#).

- [Generated Object](#)
- [Attributes](#)
- [Events](#)
- [Content](#)
- [Usage](#)
- [Examples](#)
- [Observable Attributes](#)

(Automatically generated from BeanInfo)

Generated Object

A `javax.swing.JScrollBar` is returned, unless the user passes in a subclass of `JScrollBar` as the value argument, in which case the value argument is returned.

Attributes

Declared in `javax.swing.JScrollBar`

- **UI** <ScrollBarUI> The UI object that implements the Component's LookAndFeel
- **blockIncrement** <int> The scrollbar's block increment.
- **maximum** <int> The scrollbar's maximum value.
- **minimum** <int> The scrollbar's minimum value.
- **model** <BoundedRangeModel> The scrollbar's BoundedRangeModel.
- **orientation** <int> The scrollbar's orientation.
- **unitIncrement** <int> The scrollbar's unit increment.
- **value** <int> The scrollbar's current value.
- **valueIsAdjusting** <boolean> True if the scrollbar thumb is being dragged.
- **visibleAmount** <int> The amount of the view that is currently visible.

Declared in `javax.swing.JComponent`

- **autoscrolls** <boolean> Determines if this component automatically scrolls its contents when dragged.
- **border** <Border> The component's border.
- **componentPopupMenu** <JPopupMenu> Popup to show
- **debugGraphicsOptions** <int> Diagnostic options for graphics operations.
- **inheritsPopupMenu** <boolean> Whether or not the JPopupMenu is inherited
- **inputVerifier** <InputVerifier> The component's input verifier.
- **opaque** <boolean> The component's opacity
- **toolTipText** <String> The text to display in a tool tip.
- **transferHandler** <TransferHandler> Mechanism for transfer of data to and from the component
- **verifyInputWhenFocusTarget** <boolean> Whether the Component verifies input before accepting focus.

- **UIClassID** <String>
- **accessibleContext** <AccessibleContext>
- **actionMap** <ActionMap>
- **doubleBuffered** <boolean>
- **graphics** <Graphics>
- **height** <int>
- **managingFocus** <boolean>
- **nextFocusableComponent** <Component>
- **optimizedDrawingEnabled** <boolean>
- **paintingTile** <boolean>
- **registeredKeyStrokes** <KeyStroke[]>
- **requestFocusEnabled** <boolean>
- **rootPane** <JRootPane>
- **topLevelAncestor** <Container>

- **validateRoot** <boolean>
- **visibleRect** <Rectangle>
- **width** <int>
- **x** <int>
- **y** <int>

Declared in java.awt.Container

- **alignmentX** <float>
- **alignmentY** <float>
- **componentCount** <int>
- **components** <Component[]>
- **focusCycleRoot** <boolean>
- **focusTraversalPolicy** <FocusTraversalPolicy>
- **focusTraversalPolicyProvider** <boolean>
- **focusTraversalPolicySet** <boolean>
- **insets** <Insets>
- **layout** <LayoutManager>
- **maximumSize** <Dimension>
- **minimumSize** <Dimension>
- **preferredSize** <Dimension>

Declared in java.awt.Component

- **background** <Color>
- **enabled** <boolean>
- **focusable** <boolean>
- **font**
- **foreground** <Color>
- **name** <String>
- **visible** <boolean>

Events

Declared in javax.swing.JScrollBar

- **adjustmentValueChanged** (AdjustmentEvent) - part of AdjustmentListener

Declared in javax.swing.JComponent

- **vetoableChange** (PropertyChangeEvent) - part of VetoableChangeListener
- **ancestorMoved** (AncestorEvent) - part of AncestorListener
- **ancestorAdded** (AncestorEvent) - part of AncestorListener
- **ancestorRemoved** (AncestorEvent) - part of AncestorListener

Declared in java.awt.Container

- **componentAdded** (ContainerEvent) - part of ContainerListener
- **componentRemoved** (ContainerEvent) - part of ContainerListener

Declared in java.awt.Component

- **keyPressed** (KeyEvent) - part of KeyListener
- **keyReleased** (KeyEvent) - part of KeyListener
- **keyTyped** (KeyEvent) - part of KeyListener
- **componentHidden** (ComponentEvent) - part of ComponentListener
- **componentMoved** (ComponentEvent) - part of ComponentListener
- **componentResized** (ComponentEvent) - part of ComponentListener
- **componentShown** (ComponentEvent) - part of ComponentListener
- **hierarchyChanged** (HierarchyEvent) - part of HierarchyListener
- **mouseClicked** (MouseEvent) - part of MouseListener
- **mouseEntered** (MouseEvent) - part of MouseListener

- **mouseExited** (MouseEvent) - part of MouseListener
- **mousePressed** (MouseEvent) - part of MouseListener
- **mouseReleased** (MouseEvent) - part of MouseListener
- **mouseDragged** (MouseEvent) - part of MouseMotionListener
- **mouseMoved** (MouseEvent) - part of MouseMotionListener
- **propertyChange** (PropertyChangeEvent) - part of PropertyChangeListener
- **ancestorMoved** (HierarchyEvent) - part of HierarchyBoundsListener
- **ancestorResized** (HierarchyEvent) - part of HierarchyBoundsListener
- **focusGained** (FocusEvent) - part of FocusListener
- **focusLost** (FocusEvent) - part of FocusListener
- **mouseWheelMoved** (MouseEvent) - part of MouseWheelListener
- **caretPositionChanged** (InputMethodEvent) - part of InputMethodListener
- **inputMethodTextChanged** (InputMethodEvent) - part of InputMethodListener

Content

Usage

Examples

Observable Attributes

- UI
- alignmentX
- alignmentY
- background
- blockIncrement
- border
- component
- componentCount
- componentPopupMenu
- components
- containerListeners
- enabled
- focusCycleRoot
- focusTraversalKeys
- focusTraversalPolicy
- focusTraversalPolicyProvider
- focusTraversalPolicySet
- focusable
- font
- foreground
- inheritsPopupMenu
- inputVerifier
- insets
- layout
- maximumSize
- minimumSize
- model
- opaque
- orientation
- preferredSize
- transferHandler
- unitIncrement
- verifyInputWhenFocusTarget

SwingBuilder.scrollPane

This page last changed on Mar 21, 2008 by [shemnon](#).

- [Generated Object](#)
- [Attributes](#)
- [Events](#)
- [Content](#)
- [Usage](#)
- [Examples](#)
- [Observable Attributes](#)

(Automatically generated from BeanInfo)

Generated Object

A `javax.swing.JScrollPane` is returned, unless the user passes in a subclass of `JScrollPane` as the value argument, in which case the value argument is returned.

Attributes

Declared in `javax.swing.JScrollPane`

- **UI** <ScrollPaneUI> The UI object that implements the Component's LookAndFeel.
- **columnHeader** <JViewport> The column header child for this scrollpane
- **horizontalScrollBar** <JScrollBar> The horizontal scrollbar.
- **horizontalScrollBarPolicy** <int> The scrollpane scrollbar policy
- **rowHeader** <JViewport> The row header child for this scrollpane
- **verticalScrollBar** <JScrollBar> The vertical scrollbar.
- **verticalScrollBarPolicy** <int> The scrollpane vertical scrollbar policy
- **viewport** <JViewport> The viewport child for this scrollpane
- **viewportBorder** <Border> The border around the viewport.
- **wheelScrollingEnabled** <boolean> Flag for enabling/disabling mouse wheel scrolling

- **viewportBorderBounds** <Rectangle>

Declared in `javax.swing.JComponent`

- **autoscrolls** <boolean> Determines if this component automatically scrolls its contents when dragged.
- **border** <Border> The component's border.
- **componentPopupMenu** <JPopupMenu> Popup to show
- **debugGraphicsOptions** <int> Diagnostic options for graphics operations.
- **inheritsPopupMenu** <boolean> Whether or not the JPopupMenu is inherited
- **inputVerifier** <InputVerifier> The component's input verifier.
- **opaque** <boolean> The component's opacity
- **toolTipText** <String> The text to display in a tool tip.
- **transferHandler** <TransferHandler> Mechanism for transfer of data to and from the component
- **verifyInputWhenFocusTarget** <boolean> Whether the Component verifies input before accepting focus.

- **UIClassID** <String>
- **accessibleContext** <AccessibleContext>
- **actionMap** <ActionMap>
- **doubleBuffered** <boolean>
- **graphics** <Graphics>
- **height** <int>
- **managingFocus** <boolean>
- **nextFocusableComponent** <Component>
- **optimizedDrawingEnabled** <boolean>
- **paintingTile** <boolean>
- **registeredKeyStrokes** <KeyStroke[]>
- **requestFocusEnabled** <boolean>

- **rootPane** <JRootPane>
- **topLevelAncestor** <Container>
- **validateRoot** <boolean>
- **visibleRect** <Rectangle>
- **width** <int>
- **x** <int>
- **y** <int>

Declared in java.awt.Container

- **alignmentX** <float>
- **alignmentY** <float>
- **componentCount** <int>
- **components** <Component[]>
- **focusCycleRoot** <boolean>
- **focusTraversalPolicy** <FocusTraversalPolicy>
- **focusTraversalPolicyProvider** <boolean>
- **focusTraversalPolicySet** <boolean>
- **insets** <Insets>
- **layout** <LayoutManager>
- **maximumSize** <Dimension>
- **minimumSize** <Dimension>
- **preferredSize** <Dimension>

Declared in java.awt.Component

- **background** <Color>
- **enabled** <boolean>
- **focusable** <boolean>
- **font**
- **foreground** <Color>
- **name** <String>
- **visible** <boolean>

Events

Declared in javax.swing.JComponent

- **vetoableChange** (PropertyChangeEvent) - part of VetoableChangeListener
- **ancestorMoved** (AncestorEvent) - part of AncestorListener
- **ancestorAdded** (AncestorEvent) - part of AncestorListener
- **ancestorRemoved** (AncestorEvent) - part of AncestorListener

Declared in java.awt.Container

- **componentAdded** (ContainerEvent) - part of ContainerListener
- **componentRemoved** (ContainerEvent) - part of ContainerListener

Declared in java.awt.Component

- **keyPressed** (KeyEvent) - part of KeyListener
- **keyReleased** (KeyEvent) - part of KeyListener
- **keyTyped** (KeyEvent) - part of KeyListener
- **componentHidden** (ComponentEvent) - part of ComponentListener
- **componentMoved** (ComponentEvent) - part of ComponentListener
- **componentResized** (ComponentEvent) - part of ComponentListener
- **componentShown** (ComponentEvent) - part of ComponentListener
- **hierarchyChanged** (HierarchyEvent) - part of HierarchyListener
- **mouseClicked** (MouseEvent) - part of MouseListener
- **mouseEntered** (MouseEvent) - part of MouseListener
- **mouseExited** (MouseEvent) - part of MouseListener
- **mousePressed** (MouseEvent) - part of MouseListener

- **mouseReleased** (MouseEvent) - part of MouseListener
- **mouseDragged** (MouseEvent) - part of MouseMotionListener
- **mouseMoved** (MouseEvent) - part of MouseMotionListener
- **propertyChange** (PropertyChangeEvent) - part of PropertyChangeListener
- **ancestorMoved** (HierarchyEvent) - part of HierarchyBoundsListener
- **ancestorResized** (HierarchyEvent) - part of HierarchyBoundsListener
- **focusGained** (FocusEvent) - part of FocusListener
- **focusLost** (FocusEvent) - part of FocusListener
- **mouseWheelMoved** (MouseEvent) - part of MouseWheelListener
- **caretPositionChanged** (InputMethodEvent) - part of InputMethodListener
- **inputMethodTextChanged** (InputMethodEvent) - part of InputMethodListener

Content

Usage

Examples

Observable Attributes

- UI
- alignmentX
- alignmentY
- background
- border
- columnHeader
- component
- componentCount
- componentPopupMenu
- components
- containerListeners
- enabled
- focusCycleRoot
- focusTraversalKeys
- focusTraversalPolicy
- focusTraversalPolicyProvider
- focusTraversalPolicySet
- focusable
- font
- foreground
- horizontalScrollBar
- horizontalScrollBarPolicy
- inheritsPopupMenu
- inputVerifier
- insets
- layout
- maximumSize
- minimumSize
- opaque
- preferredSize
- rowHeader
- transferHandler
- verifyInputWhenFocusTarget
- verticalScrollBar
- verticalScrollBarPolicy
- viewport
- viewportBorder
- wheelScrollingEnabled

SwingBuilder.separator

This page last changed on Mar 21, 2008 by [shemnon](#).

- [Generated Object](#)
- [Attributes](#)
- [Events](#)
- [Content](#)
- [Usage](#)
- [Examples](#)
- [Observable Attributes](#)

(Automatically generated from BeanInfo)

Generated Object

A `javax.swing.JSeparator` is returned, unless the user passes in a subclass of `JSeparator` as the value argument, in which case the value argument is returned.

Attributes

Declared in `javax.swing.JSeparator`

- **UI** <SeparatorUI> The UI object that implements the Component's LookAndFeel.
- **orientation** <int> The orientation of the separator.

Declared in `javax.swing.JComponent`

- **autoscrolls** <boolean> Determines if this component automatically scrolls its contents when dragged.
- **border** <Border> The component's border.
- **componentPopupMenu** <JPopupMenu> Popup to show
- **debugGraphicsOptions** <int> Diagnostic options for graphics operations.
- **inheritsPopupMenu** <boolean> Whether or not the JPopupMenu is inherited
- **inputVerifier** <InputVerifier> The component's input verifier.
- **opaque** <boolean> The component's opacity
- **toolTipText** <String> The text to display in a tool tip.
- **transferHandler** <TransferHandler> Mechanism for transfer of data to and from the component
- **verifyInputWhenFocusTarget** <boolean> Whether the Component verifies input before accepting focus.

- **UIClassID** <String>
- **accessibleContext** <AccessibleContext>
- **actionMap** <ActionMap>
- **doubleBuffered** <boolean>
- **graphics** <Graphics>
- **height** <int>
- **managingFocus** <boolean>
- **nextFocusableComponent** <Component>
- **optimizedDrawingEnabled** <boolean>
- **paintingTile** <boolean>
- **registeredKeyStrokes** <KeyStroke[]>
- **requestFocusEnabled** <boolean>
- **rootPane** <JRootPane>
- **topLevelAncestor** <Container>
- **validateRoot** <boolean>
- **visibleRect** <Rectangle>
- **width** <int>
- **x** <int>
- **y** <int>

Declared in java.awt.Container

- **alignmentX** <float>
- **alignmentY** <float>
- **componentCount** <int>
- **components** <Component[]>
- **focusCycleRoot** <boolean>
- **focusTraversalPolicy** <FocusTraversalPolicy>
- **focusTraversalPolicyProvider** <boolean>
- **focusTraversalPolicySet** <boolean>
- **insets** <Insets>
- **layout** <LayoutManager>
- **maximumSize** <Dimension>
- **minimumSize** <Dimension>
- **preferredSize** <Dimension>

Declared in java.awt.Component

- **background** <Color>
- **enabled** <boolean>
- **focusable** <boolean>
- **font**
- **foreground** <Color>
- **name** <String>
- **visible** <boolean>

Events

Declared in javax.swing.JComponent

- **vetoableChange** (PropertyChangeEvent) - part of VetoableChangeListener
- **ancestorMoved** (AncestorEvent) - part of AncestorListener
- **ancestorAdded** (AncestorEvent) - part of AncestorListener
- **ancestorRemoved** (AncestorEvent) - part of AncestorListener

Declared in java.awt.Container

- **componentAdded** (ContainerEvent) - part of ContainerListener
- **componentRemoved** (ContainerEvent) - part of ContainerListener

Declared in java.awt.Component

- **keyPressed** (KeyEvent) - part of KeyListener
- **keyReleased** (KeyEvent) - part of KeyListener
- **keyTyped** (KeyEvent) - part of KeyListener
- **componentHidden** (ComponentEvent) - part of ComponentListener
- **componentMoved** (ComponentEvent) - part of ComponentListener
- **componentResized** (ComponentEvent) - part of ComponentListener
- **componentShown** (ComponentEvent) - part of ComponentListener
- **hierarchyChanged** (HierarchyEvent) - part of HierarchyListener
- **mouseClicked** (MouseEvent) - part of MouseListener
- **mouseEntered** (MouseEvent) - part of MouseListener
- **mouseExited** (MouseEvent) - part of MouseListener
- **mousePressed** (MouseEvent) - part of MouseListener
- **mouseReleased** (MouseEvent) - part of MouseListener
- **mouseDragged** (MouseEvent) - part of MouseMotionListener
- **mouseMoved** (MouseEvent) - part of MouseMotionListener
- **propertyChange** (PropertyChangeEvent) - part of PropertyChangeListener
- **ancestorMoved** (HierarchyEvent) - part of HierarchyBoundsListener
- **ancestorResized** (HierarchyEvent) - part of HierarchyBoundsListener
- **focusGained** (FocusEvent) - part of FocusListener
- **focusLost** (FocusEvent) - part of FocusListener

- **mouseWheelMoved** (MouseEvent) - part of MouseWheelListener
- **caretPositionChanged** (InputMethodEvent) - part of InputMethodListener
- **inputMethodTextChanged** (InputMethodEvent) - part of InputMethodListener

Content

Usage

Examples

Observable Attributes

- UI
- alignmentX
- alignmentY
- background
- border
- component
- componentCount
- componentPopupMenu
- components
- containerListeners
- enabled
- focusCycleRoot
- focusTraversalKeys
- focusTraversalPolicy
- focusTraversalPolicyProvider
- focusTraversalPolicySet
- focusable
- font
- foreground
- inheritsPopupMenu
- inputVerifier
- insets
- layout
- maximumSize
- minimumSize
- opaque
- orientation
- preferredSize
- transferHandler
- verifyInputWhenFocusTarget

SwingBuilder.slider

This page last changed on Nov 01, 2007 by [shemnon](#).

Generated Object

A `javax.swing.JSlider` is returned, unless the user passes in a subclass of `JSlider` as the value argument, in which case the value argument is returned.

Attributes

See also: [JComponent](#)

- `extent` <int> Size of the range covered by the knob.
- `inverted` <boolean> If true reverses the slider values from their normal order
- `labelTable` <Dictionary> Specifies what labels will be drawn for any given value.
- `majorTickSpacing` <int> Sets the number of values between major tick marks.
- `maximum` <int> The sliders maximum value.
- `minimum` <int> The sliders minimum value.
- `minorTickSpacing` <int> Sets the number of values between minor tick marks.
- `model` <BoundedRangeModel> The sliders `BoundedRangeModel`.
- `orientation` <int> Set the scrollbars orientation to either `VERTICAL` or `HORIZONTAL`.
- `paintLabels` <boolean> If true labels are painted on the slider.
- `paintTicks` <boolean> If true tick marks are painted on the slider.
- `paintTrack` <boolean> If true, the track is painted on the slider.
- `snapToTicks` <boolean> If true snap the knob to the nearest tick mark.
- `value` <int> The sliders current value.

Content

No child content is accepted in a slider.

Examples

```
//TODO
```

Observable Attributes

The following properties are observable and can be used as `sourceProperty` in `bind()`:

- `value` - via synthetic observation
- `inverted`
- `labelTable`
- `majorTickSpacing`
- `maximum`
- `minimum`
- `minorTickSpacing`
- `model`
- `orientation`
- `paintLabels`
- `paintTicks`
- `paintTrack`
- `snapToTicks`

SwingBuilder.spinner

This page last changed on Mar 21, 2008 by [shemnon](#).

- [Generated Object](#)
- [Attributes](#)
- [Events](#)
- [Content](#)
- [Usage](#)
- [Examples](#)
- [Observable Attributes](#)

(Automatically generated from BeanInfo)

Generated Object

A `javax.swing.JSpinner` is returned, unless the user passes in a subclass of `JSpinner` as the value argument, in which case the value argument is returned.

Attributes

Declared in `javax.swing.JSpinner`

- **editor** <JComponent> JComponent that displays the current value of the model
- **model** <SpinnerModel> Model that represents the value of this spinner.
- **UI** <SpinnerUI>
- **nextValue** <Object>
- **previousValue** <Object>
- **value** <Object>

Declared in `javax.swing.JComponent`

- **autoscrolls** <boolean> Determines if this component automatically scrolls its contents when dragged.
- **border** <Border> The component's border.
- **componentPopupMenu** <JPopupMenu> Popup to show
- **debugGraphicsOptions** <int> Diagnostic options for graphics operations.
- **inheritsPopupMenu** <boolean> Whether or not the JPopupMenu is inherited
- **inputVerifier** <InputVerifier> The component's input verifier.
- **opaque** <boolean> The component's opacity
- **toolTipText** <String> The text to display in a tool tip.
- **transferHandler** <TransferHandler> Mechanism for transfer of data to and from the component
- **verifyInputWhenFocusTarget** <boolean> Whether the Component verifies input before accepting focus.
- **UIClassID** <String>
- **accessibleContext** <AccessibleContext>
- **actionMap** <ActionMap>
- **doubleBuffered** <boolean>
- **graphics** <Graphics>
- **height** <int>
- **managingFocus** <boolean>
- **nextFocusableComponent** <Component>
- **optimizedDrawingEnabled** <boolean>
- **paintingTile** <boolean>
- **registeredKeyStrokes** <KeyStroke[]>
- **requestFocusEnabled** <boolean>
- **rootPane** <JRootPane>
- **topLevelAncestor** <Container>
- **validateRoot** <boolean>
- **visibleRect** <Rectangle>
- **width** <int>

- **x** <int>
- **y** <int>

Declared in `java.awt.Container`

- **alignmentX** <float>
- **alignmentY** <float>
- **componentCount** <int>
- **components** <Component[]>
- **focusCycleRoot** <boolean>
- **focusTraversalPolicy** <FocusTraversalPolicy>
- **focusTraversalPolicyProvider** <boolean>
- **focusTraversalPolicySet** <boolean>
- **insets** <Insets>
- **layout** <LayoutManager>
- **maximumSize** <Dimension>
- **minimumSize** <Dimension>
- **preferredSize** <Dimension>

Declared in `java.awt.Component`

- **background** <Color>
- **enabled** <boolean>
- **focusable** <boolean>
- **font**
- **foreground** <Color>
- **name** <String>
- **visible** <boolean>

Events

Declared in `javax.swing.JSpinner`

- **stateChanged** (ChangeEvent) - part of ChangeListener

Declared in `javax.swing.JComponent`

- **vetoableChange** (PropertyChangeEvent) - part of VetoableChangeListener
- **ancestorMoved** (AncestorEvent) - part of AncestorListener
- **ancestorAdded** (AncestorEvent) - part of AncestorListener
- **ancestorRemoved** (AncestorEvent) - part of AncestorListener

Declared in `java.awt.Container`

- **componentAdded** (ContainerEvent) - part of ContainerListener
- **componentRemoved** (ContainerEvent) - part of ContainerListener

Declared in `java.awt.Component`

- **keyPressed** (KeyEvent) - part of KeyListener
- **keyReleased** (KeyEvent) - part of KeyListener
- **keyTyped** (KeyEvent) - part of KeyListener
- **componentHidden** (ComponentEvent) - part of ComponentListener
- **componentMoved** (ComponentEvent) - part of ComponentListener
- **componentResized** (ComponentEvent) - part of ComponentListener
- **componentShown** (ComponentEvent) - part of ComponentListener
- **hierarchyChanged** (HierarchyEvent) - part of HierarchyListener
- **mouseClicked** (MouseEvent) - part of MouseListener
- **mouseEntered** (MouseEvent) - part of MouseListener
- **mouseExited** (MouseEvent) - part of MouseListener
- **mousePressed** (MouseEvent) - part of MouseListener
- **mouseReleased** (MouseEvent) - part of MouseListener

- **mouseDragged** (MouseEvent) - part of MouseMotionListener
- **mouseMoved** (MouseEvent) - part of MouseMotionListener
- **propertyChange** (PropertyChangeEvent) - part of PropertyChangeListener
- **ancestorMoved** (HierarchyEvent) - part of HierarchyBoundsListener
- **ancestorResized** (HierarchyEvent) - part of HierarchyBoundsListener
- **focusGained** (FocusEvent) - part of FocusListener
- **focusLost** (FocusEvent) - part of FocusListener
- **mouseWheelMoved** (MouseEvent) - part of MouseWheelListener
- **caretPositionChanged** (InputMethodEvent) - part of InputMethodListener
- **inputMethodTextChanged** (InputMethodEvent) - part of InputMethodListener

Content

Usage

Examples

Observable Attributes

- alignmentX
- alignmentY
- background
- border
- component
- componentCount
- componentPopupMenu
- components
- containerListeners
- editor
- enabled
- focusCycleRoot
- focusTraversalKeys
- focusTraversalPolicy
- focusTraversalPolicyProvider
- focusTraversalPolicySet
- focusable
- font
- foreground
- inheritsPopupMenu
- inputVerifier
- insets
- layout
- maximumSize
- minimumSize
- model
- opaque
- preferredSize
- transferHandler
- verifyInputWhenFocusTarget

SwingBuilder.spinnerDateModel

This page last changed on Mar 21, 2008 by [shemnon](#).

- [Generated Object](#)
- [Attributes](#)
- [Events](#)
- [Content](#)
- [Usage](#)
- [Examples](#)

(Automatically generated from BeanInfo)

Generated Object

A `javax.swing.SpinnerDateModel` is returned, unless the user passes in a subclass of `SpinnerDateModel` as the value argument, in which case the value argument is returned.

Attributes

Declared in `javax.swing.SpinnerDateModel`

- **calendarField** <int>
- **date** <Date>
- **end** <Comparable>
- **nextValue** <Object>
- **previousValue** <Object>
- **start** <Comparable>
- **value** <Object>

Events

Declared in `javax.swing.AbstractSpinnerModel`

- **stateChanged** (ChangeEvent) - part of ChangeListener

Content

Usage

Examples

SwingBuilder.spinnerListModel

This page last changed on Mar 21, 2008 by [shemnon](#).

- [Generated Object](#)
- [Attributes](#)
- [Events](#)
- [Content](#)
- [Usage](#)
- [Examples](#)

(Automatically generated from BeanInfo)

Generated Object

A `javax.swing.SpinnerListModel` is returned, unless the user passes in a subclass of `SpinnerListModel` as the value argument, in which case the value argument is returned.

Attributes

Declared in `javax.swing.SpinnerListModel`

- **list** <List>
- **nextValue** <Object>
- **previousValue** <Object>
- **value** <Object>

Events

Declared in `javax.swing.AbstractSpinnerModel`

- **stateChanged** (`ChangeEvent`) - part of `ChangeListener`

Content

Usage

Examples

SwingBuilder.spinnerNumberModel

This page last changed on Mar 21, 2008 by [shemnon](#).

- [Generated Object](#)
- [Attributes](#)
- [Events](#)
- [Content](#)
- [Usage](#)
- [Examples](#)

(Automatically generated from BeanInfo)

Generated Object

A `javax.swing.SpinnerNumberModel` is returned, unless the user passes in a subclass of `SpinnerNumberModel` as the value argument, in which case the value argument is returned.

Attributes

Declared in `javax.swing.SpinnerNumberModel`

- **maximum** <Comparable>
- **minimum** <Comparable>
- **nextValue** <Object>
- **number** <Number>
- **previousValue** <Object>
- **stepSize** <Number>
- **value** <Object>

Events

Declared in `javax.swing.AbstractSpinnerModel`

- **stateChanged** (ChangeEvent) - part of ChangeListener

Content

Usage

Examples

SwingBuilder.splitPane

This page last changed on Mar 21, 2008 by [shemnon](#).

- [Generated Object](#)
- [Attributes](#)
- [Events](#)
- [Content](#)
- [Usage](#)
- [Examples](#)
- [Observable Attributes](#)

(Automatically generated from BeanInfo)

Generated Object

A `javax.swing.JSplitPane` is returned, unless the user passes in a subclass of `JSplitPane` as the value argument, in which case the value argument is returned.

Attributes

Declared in `javax.swing.JSplitPane`

- **UI** <SplitPaneUI> The L&F object that renders this component.
- **bottomComponent** <Component> The component below, or to the right of the divider.
- **continuousLayout** <boolean> Whether the child components are continuously redisplayed and laid out during user intervention.
- **dividerLocation** <int> The location of the divider.
- **dividerSize** <int> The size of the divider.
- **lastDividerLocation** <int> The last location the divider was at.
- **leftComponent** <Component> The component to the left (or above) the divider.
- **minimumDividerLocation** <int> The minimum location of the divider from the L&F.
- **oneTouchExpandable** <boolean> UI widget on the divider to quickly expand/collapse the divider.
- **orientation** <int> The orientation, or how the splitter is divided.
- **resizeWeight** <double> Specifies how to distribute extra space when the split pane resizes.
- **rightComponent** <Component> The component to the right (or below) the divider.
- **topComponent** <Component> The component above, or to the left of the divider.

- **maximumDividerLocation** <int>

Declared in `javax.swing.JComponent`

- **autoscrolls** <boolean> Determines if this component automatically scrolls its contents when dragged.
- **border** <Border> The component's border.
- **componentPopupMenu** <JPopupMenu> Popup to show
- **debugGraphicsOptions** <int> Diagnostic options for graphics operations.
- **inheritsPopupMenu** <boolean> Whether or not the JPopupMenu is inherited
- **inputVerifier** <InputVerifier> The component's input verifier.
- **opaque** <boolean> The component's opacity
- **toolTipText** <String> The text to display in a tool tip.
- **transferHandler** <TransferHandler> Mechanism for transfer of data to and from the component
- **verifyInputWhenFocusTarget** <boolean> Whether the Component verifies input before accepting focus.

- **UIClassID** <String>
- **accessibleContext** <AccessibleContext>
- **actionMap** <ActionMap>
- **doubleBuffered** <boolean>
- **graphics** <Graphics>
- **height** <int>
- **managingFocus** <boolean>
- **nextFocusableComponent** <Component>
- **optimizedDrawingEnabled** <boolean>

- **paintingTile** <boolean>
- **registeredKeyStrokes** <KeyStroke[]>
- **requestFocusEnabled** <boolean>
- **rootPane** <JRootPane>
- **topLevelAncestor** <Container>
- **validateRoot** <boolean>
- **visibleRect** <Rectangle>
- **width** <int>
- **x** <int>
- **y** <int>

Declared in `java.awt.Container`

- **alignmentX** <float>
- **alignmentY** <float>
- **componentCount** <int>
- **components** <Component[]>
- **focusCycleRoot** <boolean>
- **focusTraversalPolicy** <FocusTraversalPolicy>
- **focusTraversalPolicyProvider** <boolean>
- **focusTraversalPolicySet** <boolean>
- **insets** <Insets>
- **layout** <LayoutManager>
- **maximumSize** <Dimension>
- **minimumSize** <Dimension>
- **preferredSize** <Dimension>

Declared in `java.awt.Component`

- **background** <Color>
- **enabled** <boolean>
- **focusable** <boolean>
- **font**
- **foreground** <Color>
- **name** <String>
- **visible** <boolean>

Events

Declared in `javax.swing.JComponent`

- **vetoableChange** (PropertyChangeEvent) - part of VetoableChangeListener
- **ancestorMoved** (AncestorEvent) - part of AncestorListener
- **ancestorAdded** (AncestorEvent) - part of AncestorListener
- **ancestorRemoved** (AncestorEvent) - part of AncestorListener

Declared in `java.awt.Container`

- **componentAdded** (ContainerEvent) - part of ContainerListener
- **componentRemoved** (ContainerEvent) - part of ContainerListener

Declared in `java.awt.Component`

- **keyPressed** (KeyEvent) - part of KeyListener
- **keyReleased** (KeyEvent) - part of KeyListener
- **keyTyped** (KeyEvent) - part of KeyListener
- **componentHidden** (ComponentEvent) - part of ComponentListener
- **componentMoved** (ComponentEvent) - part of ComponentListener
- **componentResized** (ComponentEvent) - part of ComponentListener
- **componentShown** (ComponentEvent) - part of ComponentListener
- **hierarchyChanged** (HierarchyEvent) - part of HierarchyListener
- **mouseClicked** (MouseEvent) - part of MouseListener

- **mouseEntered** (MouseEvent) - part of MouseListener
- **mouseExited** (MouseEvent) - part of MouseListener
- **mousePressed** (MouseEvent) - part of MouseListener
- **mouseReleased** (MouseEvent) - part of MouseListener
- **mouseDragged** (MouseEvent) - part of MouseMotionListener
- **mouseMoved** (MouseEvent) - part of MouseMotionListener
- **propertyChange** (PropertyChangeEvent) - part of PropertyChangeListener
- **ancestorMoved** (HierarchyEvent) - part of HierarchyBoundsListener
- **ancestorResized** (HierarchyEvent) - part of HierarchyBoundsListener
- **focusGained** (FocusEvent) - part of FocusListener
- **focusLost** (FocusEvent) - part of FocusListener
- **mouseWheelMoved** (MouseEvent) - part of MouseWheelListener
- **caretPositionChanged** (InputMethodEvent) - part of InputMethodListener
- **inputMethodTextChanged** (InputMethodEvent) - part of InputMethodListener

Content

Usage

Examples

Observable Attributes

- alignmentX
- alignmentY
- background
- border
- component
- componentCount
- componentPopupMenu
- components
- containerListeners
- continuousLayout
- dividerLocation
- dividerSize
- enabled
- focusCycleRoot
- focusTraversalKeys
- focusTraversalPolicy
- focusTraversalPolicyProvider
- focusTraversalPolicySet
- focusable
- font
- foreground
- inheritsPopupMenu
- inputVerifier
- insets
- lastDividerLocation
- layout
- maximumSize
- minimumSize
- oneTouchExpandable
- opaque
- orientation
- preferredSize
- resizeWeight
- transferHandler
- verifyInputWhenFocusTarget

SwingBuilder.springLayout

This page last changed on Mar 21, 2008 by [shemnon](#).

- [Generated Object](#)
- [Attributes](#)
- [Events](#)
- [Content](#)
- [Usage](#)
- [Examples](#)

(Automatically generated from BeanInfo)

Generated Object

A javax.swing.SpringLayout is returned, unless the user passes in a subclass of SpringLayout as the value argument, in which case the value argument is returned.

Attributes

Events

Content

Usage

Examples

SwingBuilder.tabbedPane

This page last changed on Nov 01, 2007 by [shemnon](#).

Generated Object

A JTabbedPane

Value Argument

The tabbedPane() node accepts no value argument.

Attributes

In addition to [JComponent](#) attributes, tabbedPane supports these additional attributes:

- **model** <SingleSelectionModel> The model that tracks the tab selection. not normally set by the end user.
- **tabPlacement** <int> One of JTabbedPane.TOP, JTabbedPane.BOTTOM, JTabbedPane.LEFT, or JTabbedPane.RIGHT, indicates where the tabs should be placed.
- **tabLayoutPolicy** <int> One of JTabbedPane.WRAP_TAB_LAYOUT or JTabbedPane.SCROLL_TAB_LAYOUT. Determines the behavior of the tabs when there are too many for one line. Either multiple lines, or a single line with scroll controls (respectively)
- **selectedIndex** <int> The tab index to be selected initially. Do not combine with selectedComponent
- **selectedComponent** <Component> The tab representing the component to be selected initially. Do not combine with selectedIndex.

Content

All immediate children of the JTabbedPane that are Components are added to the tabbed pane as tabs. In addition, these children also can have the following attributes, which apply to the tab representing those components

- **title** <String> The text title on the tab. If this is missing the name property of the component is used (which defaults to an empty string)
- **tabIcon** <Icon> The icon to be used on the tab, usually to the left of the text.
- **tabDisabledIcon** <Icon> The icon to be displayed when the tab is disabled. If tabIcon: is specified but tabDisabledIcon isn't then a disable icon will be automatically generated base on the Look and Feel.
- **tabToolTip** <String> The tooltip to be displayed when the mouse is hovering over the tab. (note that this is different than the component in the tab, use tooltip: for the component itself)
- **tabBackground** <Color> The background color of the tab. If this isn't specified a Look and Feel dependent value will be provided. The Look and Feel may ignore this (Windows Vista does)
- **tabForeground** <Color> The foreground text color of the tab. If this isn't specified a Look and Feel dependent value will be provided. The Look and Feel may ignore this (Windows Vista does)
- **tabEnabled** <boolean> A flag to indicate whether or not this tab should be considered activated and accessible.
- **tabMnemonic** <int or String or char> The mnemonic of the tab to be used for keyboard navigation. Do not combine with tabDisplayedMnemonicIndex unless the characters match up. Character must be in title/upper case
- **tabDisplayedMnemonicIndex** <int> The character index in the title to use for the mnemonic. Useful when a more prominent character should be used, like "Stop Operation", a mnemonic of O would ordinarily underline the 'o' in Stop.

Examples

```
tabbedPane(tabPlacement: JTabbedPane.LEFT) {
  label('One', title:'One', tabToolTip:'Uno!')
  label('Green', title:'Green', tabBackground:java.awt.Color.GREEN)
  label('Stop Operation', title:'Stop Operation', tabMnemonic:'O')
  label('Stop Operation', title:'Stop Operation', tabDisplayedMnemonicIndex:5)
}
```

SwingBuilder.table

This page last changed on Mar 21, 2008 by [shemnon](#).

- [Generated Object](#)
- [Attributes](#)
- [Events](#)
- [Content](#)
- [Usage](#)
- [Examples](#)
- [Observable Attributes](#)

(Automatically generated from BeanInfo)

Generated Object

A `javax.swing.JTable` is returned, unless the user passes in a subclass of `JTable` as the value argument, in which case the value argument is returned.

Attributes

Declared in `javax.swing.JTable`

- **UI** `<TableUI>` The UI object that implements the Component's LookAndFeel.
- **autoCreateColumnsFromModel** `<boolean>` Automatically populates the columnModel when a new TableModel is submitted.
- **autoResizeMode** `<int>` Whether the columns should adjust themselves automatically.
- **cellEditor** `<TableCellEditor>` The table's active cell editor.
- **cellSelectionEnabled** `<boolean>` Select a rectangular region of cells rather than rows or columns.
- **columnModel** `<TableColumnModel>` The object governing the way columns appear in the view.
- **columnSelectionAllowed** `<boolean>` If true, an entire column is selected for each selected cell.
- **dragEnabled** `<boolean>` determines whether automatic drag handling is enabled
- **gridColor** `<Color>` The grid color.
- **intercellSpacing** `<Dimension>` The spacing between the cells, drawn in the background color of the JTable.
- **model** `<TableModel>` The model that is the source of the data for this view.
- **preferredScrollableViewportSize** `<Dimension>` The preferred size of the viewport.
- **rowMargin** `<int>` The amount of space between cells.
- **rowSelectionAllowed** `<boolean>` If true, an entire row is selected for each selected cell.
- **selectionBackground** `<Color>` A default background color for selected cells.
- **selectionForeground** `<Color>` A default foreground color for selected cells.
- **selectionModel** `<ListSelectionModel>` The selection model for rows.
- **showHorizontalLines** `<boolean>` Whether horizontal lines should be drawn in between the cells.
- **showVerticalLines** `<boolean>` Whether vertical lines should be drawn in between the cells.
- **tableHeader** `<JTableHeader>` The JTableHeader instance which renders the column headers.

- **columnCount** `<int>`
- **editing** `<boolean>`
- **editingColumn** `<int>`
- **editingRow** `<int>`
- **editorComponent** `<Component>`
- **rowCount** `<int>`
- **scrollableTracksViewportHeight** `<boolean>`
- **scrollableTracksViewportWidth** `<boolean>`
- **selectedColumn** `<int>`
- **selectedColumnCount** `<int>`
- **selectedColumns** `<int[]>`
- **selectedRow** `<int>`
- **selectedRowCount** `<int>`
- **selectedRows** `<int[]>`
- **surrendersFocusOnKeystroke** `<boolean>`

Declared in javax.swing.JComponent

- **autoscrolls** <boolean> Determines if this component automatically scrolls its contents when dragged.
- **border** <Border> The component's border.
- **componentPopupMenu** <JPopupMenu> Popup to show
- **debugGraphicsOptions** <int> Diagnostic options for graphics operations.
- **inheritsPopupMenu** <boolean> Whether or not the JPopupMenu is inherited
- **inputVerifier** <InputVerifier> The component's input verifier.
- **opaque** <boolean> The component's opacity
- **toolTipText** <String> The text to display in a tool tip.
- **transferHandler** <TransferHandler> Mechanism for transfer of data to and from the component
- **verifyInputWhenFocusTarget** <boolean> Whether the Component verifies input before accepting focus.

- **UIClassID** <String>
- **accessibleContext** <AccessibleContext>
- **actionMap** <ActionMap>
- **doubleBuffered** <boolean>
- **graphics** <Graphics>
- **height** <int>
- **managingFocus** <boolean>
- **nextFocusableComponent** <Component>
- **optimizedDrawingEnabled** <boolean>
- **paintingTile** <boolean>
- **registeredKeyStrokes** <KeyStroke[]>
- **requestFocusEnabled** <boolean>
- **rootPane** <JRootPane>
- **topLevelAncestor** <Container>
- **validateRoot** <boolean>
- **visibleRect** <Rectangle>
- **width** <int>
- **x** <int>
- **y** <int>

Declared in java.awt.Container

- **alignmentX** <float>
- **alignmentY** <float>
- **componentCount** <int>
- **components** <Component[]>
- **focusCycleRoot** <boolean>
- **focusTraversalPolicy** <FocusTraversalPolicy>
- **focusTraversalPolicyProvider** <boolean>
- **focusTraversalPolicySet** <boolean>
- **insets** <Insets>
- **layout** <LayoutManager>
- **maximumSize** <Dimension>
- **minimumSize** <Dimension>
- **preferredSize** <Dimension>

Declared in java.awt.Component

- **background** <Color>
- **enabled** <boolean>
- **focusable** <boolean>
- **font**
- **foreground** <Color>
- **name** <String>
- **visible** <boolean>

Events

Declared in `javax.swing.JComponent`

- **vetoableChange** (`PropertyChangeEvent`) - part of `VetoableChangeListener`
- **ancestorMoved** (`AncestorEvent`) - part of `AncestorListener`
- **ancestorAdded** (`AncestorEvent`) - part of `AncestorListener`
- **ancestorRemoved** (`AncestorEvent`) - part of `AncestorListener`

Declared in `java.awt.Container`

- **componentAdded** (`ContainerEvent`) - part of `ContainerListener`
- **componentRemoved** (`ContainerEvent`) - part of `ContainerListener`

Declared in `java.awt.Component`

- **keyPressed** (`KeyEvent`) - part of `KeyListener`
- **keyReleased** (`KeyEvent`) - part of `KeyListener`
- **keyTyped** (`KeyEvent`) - part of `KeyListener`
- **componentHidden** (`ComponentEvent`) - part of `ComponentListener`
- **componentMoved** (`ComponentEvent`) - part of `ComponentListener`
- **componentResized** (`ComponentEvent`) - part of `ComponentListener`
- **componentShown** (`ComponentEvent`) - part of `ComponentListener`
- **hierarchyChanged** (`HierarchyEvent`) - part of `HierarchyListener`
- **mouseClicked** (`MouseEvent`) - part of `MouseListener`
- **mouseEntered** (`MouseEvent`) - part of `MouseListener`
- **mouseExited** (`MouseEvent`) - part of `MouseListener`
- **mousePressed** (`MouseEvent`) - part of `MouseListener`
- **mouseReleased** (`MouseEvent`) - part of `MouseListener`
- **mouseDragged** (`MouseEvent`) - part of `MouseMotionListener`
- **mouseMoved** (`MouseEvent`) - part of `MouseMotionListener`
- **propertyChange** (`PropertyChangeEvent`) - part of `PropertyChangeListener`
- **ancestorMoved** (`HierarchyEvent`) - part of `HierarchyBoundsListener`
- **ancestorResized** (`HierarchyEvent`) - part of `HierarchyBoundsListener`
- **focusGained** (`FocusEvent`) - part of `FocusListener`
- **focusLost** (`FocusEvent`) - part of `FocusListener`
- **mouseWheelMoved** (`MouseEvent`) - part of `MouseWheelListener`
- **caretPositionChanged** (`InputMethodEvent`) - part of `InputMethodListener`
- **inputMethodTextChanged** (`InputMethodEvent`) - part of `InputMethodListener`

Content

Usage

Examples

Observable Attributes

- `UI`
- `alignmentX`
- `alignmentY`
- `autoCreateColumnsFromModel`
- `autoResizeMode`
- `background`
- `border`
- `cellEditor`
- `cellSelectionEnabled`
- `columnModel`
- `columnSelectionAllowed`
- `component`

- componentCount
- componentPopupMenu
- components
- containerListeners
- enabled
- focusCycleRoot
- focusTraversalKeys
- focusTraversalPolicy
- focusTraversalPolicyProvider
- focusTraversalPolicySet
- focusable
- font
- foreground
- gridColor
- inheritsPopupMenu
- inputVerifier
- insets
- layout
- maximumSize
- minimumSize
- model
- opaque
- preferredSize
- rowMargin
- rowSelectionAllowed
- selectionBackground
- selectionForeground
- selectionModel
- showHorizontalLines
- showVerticalLines
- tableHeader
- transferHandler
- verifyInputWhenFocusTarget

SwingBuilder.tableColumn

This page last changed on Mar 21, 2008 by [shemnon](#).

- [Generated Object](#)
- [Attributes](#)
- [Events](#)
- [Content](#)
- [Usage](#)
- [Examples](#)
- [Observable Attributes](#)

(Automatically generated from BeanInfo)

Generated Object

A `javax.swing.table.TableColumn` is returned, unless the user passes in a subclass of `TableColumn` as the value argument, in which case the value argument is returned.

Attributes

Declared in `javax.swing.table.TableColumn`

- **cellEditor** <TableCellEditor>
- **cellRenderer** <TableCellRenderer>
- **headerRenderer** <TableCellRenderer>
- **headerValue** <Object>
- **identifier** <Object>
- **maxWidth** <int>
- **minWidth** <int>
- **modelIndex** <int>
- **preferredWidth** <int>
- **resizable** <boolean>
- **width** <int>

Events

Declared in `javax.swing.table.TableColumn`

- **propertyChange** (PropertyChangeEvent) - part of PropertyChangeListener

Content

Usage

Examples

Observable Attributes

- cellEditor
- cellRenderer
- headerRenderer
- headerValue
- identifier
- maxWidth
- minWidth
- modelIndex
- preferredWidth
- propertyChangeListeners
- resizable
- width

SwingBuilder.tableLayout

This page last changed on Mar 21, 2008 by [shemnon](#).

- [Generated Object](#)
- [Attributes](#)
- [Events](#)
- [Content](#)
- [Usage](#)
- [Examples](#)
- [Observable Attributes](#)

(Automatically generated from BeanInfo)

Generated Object

A `groovy.swing.impl.TableLayout` is returned, unless the user passes in a subclass of `TableLayout` as the value argument, in which case the value argument is returned.

Attributes

Declared in `groovy.swing.impl.TableLayout`

- **cellpadding** <int>

Declared in `javax.swing.JPanel`

- **UI** <PanelUI> The UI object that implements the Component's LookAndFeel.

Declared in `javax.swing.JComponent`

- **autoscrolls** <boolean> Determines if this component automatically scrolls its contents when dragged.
- **border** <Border> The component's border.
- **componentPopupMenu** <JPopupMenu> Popup to show
- **debugGraphicsOptions** <int> Diagnostic options for graphics operations.
- **inheritsPopupMenu** <boolean> Whether or not the JPopupMenu is inherited
- **inputVerifier** <InputVerifier> The component's input verifier.
- **opaque** <boolean> The component's opacity
- **toolTipText** <String> The text to display in a tool tip.
- **transferHandler** <TransferHandler> Mechanism for transfer of data to and from the component
- **verifyInputWhenFocusTarget** <boolean> Whether the Component verifies input before accepting focus.

- **UIClassID** <String>
- **accessibleContext** <AccessibleContext>
- **actionMap** <ActionMap>
- **doubleBuffered** <boolean>
- **graphics** <Graphics>
- **height** <int>
- **managingFocus** <boolean>
- **nextFocusableComponent** <Component>
- **optimizedDrawingEnabled** <boolean>
- **paintingTile** <boolean>
- **registeredKeyStrokes** <KeyStroke[]>
- **requestFocusEnabled** <boolean>
- **rootPane** <JRootPane>
- **topLevelAncestor** <Container>
- **validateRoot** <boolean>
- **visibleRect** <Rectangle>
- **width** <int>
- **x** <int>
- **y** <int>

Declared in java.awt.Container

- **alignmentX** <float>
- **alignmentY** <float>
- **componentCount** <int>
- **components** <Component[]>
- **focusCycleRoot** <boolean>
- **focusTraversalPolicy** <FocusTraversalPolicy>
- **focusTraversalPolicyProvider** <boolean>
- **focusTraversalPolicySet** <boolean>
- **insets** <Insets>
- **layout** <LayoutManager>
- **maximumSize** <Dimension>
- **minimumSize** <Dimension>
- **preferredSize** <Dimension>

Declared in java.awt.Component

- **background** <Color>
- **enabled** <boolean>
- **focusable** <boolean>
- **font**
- **foreground** <Color>
- **name** <String>
- **visible** <boolean>

Events

Declared in javax.swing.JComponent

- **vetoableChange** (PropertyChangeEvent) - part of VetoableChangeListener
- **ancestorMoved** (AncestorEvent) - part of AncestorListener
- **ancestorAdded** (AncestorEvent) - part of AncestorListener
- **ancestorRemoved** (AncestorEvent) - part of AncestorListener

Declared in java.awt.Container

- **componentAdded** (ContainerEvent) - part of ContainerListener
- **componentRemoved** (ContainerEvent) - part of ContainerListener

Declared in java.awt.Component

- **keyPressed** (KeyEvent) - part of KeyListener
- **keyReleased** (KeyEvent) - part of KeyListener
- **keyTyped** (KeyEvent) - part of KeyListener
- **componentHidden** (ComponentEvent) - part of ComponentListener
- **componentMoved** (ComponentEvent) - part of ComponentListener
- **componentResized** (ComponentEvent) - part of ComponentListener
- **componentShown** (ComponentEvent) - part of ComponentListener
- **hierarchyChanged** (HierarchyEvent) - part of HierarchyListener
- **mouseClicked** (MouseEvent) - part of MouseListener
- **mouseEntered** (MouseEvent) - part of MouseListener
- **mouseExited** (MouseEvent) - part of MouseListener
- **mousePressed** (MouseEvent) - part of MouseListener
- **mouseReleased** (MouseEvent) - part of MouseListener
- **mouseDragged** (MouseEvent) - part of MouseMotionListener
- **mouseMoved** (MouseEvent) - part of MouseMotionListener
- **propertyChange** (PropertyChangeEvent) - part of PropertyChangeListener
- **ancestorMoved** (HierarchyEvent) - part of HierarchyBoundsListener
- **ancestorResized** (HierarchyEvent) - part of HierarchyBoundsListener
- **focusGained** (FocusEvent) - part of FocusListener
- **focusLost** (FocusEvent) - part of FocusListener

- **mouseWheelMoved** (MouseEvent) - part of MouseWheelListener
- **caretPositionChanged** (InputMethodEvent) - part of InputMethodListener
- **inputMethodTextChanged** (InputMethodEvent) - part of InputMethodListener

Content

Usage

Examples

Observable Attributes

- UI
- alignmentX
- alignmentY
- background
- border
- cellpadding
- component
- componentCount
- componentPopupMenu
- components
- containerListeners
- enabled
- focusCycleRoot
- focusTraversalKeys
- focusTraversalPolicy
- focusTraversalPolicyProvider
- focusTraversalPolicySet
- focusable
- font
- foreground
- inheritsPopupMenu
- inputVerifier
- insets
- layout
- maximumSize
- minimumSize
- opaque
- preferredSize
- transferHandler
- verifyInputWhenFocusTarget

SwingBuilder.tableModel

This page last changed on Mar 21, 2008 by [shemnon](#).

- [Generated Object](#)
- [Attributes](#)
- [Events](#)
- [Content](#)
- [Usage](#)
- [Examples](#)

(Automatically generated from BeanInfo)

Generated Object

A `groovy.model.DefaultTableModel` is returned, unless the user passes in a subclass of `DefaultTableModel` as the value argument, in which case the value argument is returned.

Attributes

Declared in `groovy.model.DefaultTableModel`

- **columnCount** <int>
- **columnList** <List>
- **columnModel** <TableColumnModel>
- **rowCount** <int>
- **rowModel** <ValueModel>
- **rowsModel** <ValueModel>

Events

Declared in `javax.swing.table.AbstractTableModel`

- **tableChanged** (TableModelEvent) - part of TableModelListener

Content

Usage

Examples

SwingBuilder.td

This page last changed on Mar 21, 2008 by [shemnon](#).

- [Generated Object](#)
- [Attributes](#)
- [Events](#)
- [Content](#)
- [Usage](#)
- [Examples](#)

(Automatically generated from BeanInfo)

Generated Object

A `groovy.swing.impl.TableLayoutCell` is returned, unless the user passes in a subclass of `TableLayoutCell` as the value argument, in which case the value argument is returned.

Attributes

Declared in `groovy.swing.impl.TableLayoutCell`

- **align** <String>
- **colfill** <boolean>
- **colspan** <int>
- **component** <Component>
- **constraints** <GridBagConstraints>
- **rowfill** <boolean>
- **rowspan** <int>
- **valign** <String>

Events

Content

Usage

Examples

SwingBuilder.textArea

This page last changed on Mar 21, 2008 by [shemnon](#).

- [Generated Object](#)
- [Attributes](#)
- [Events](#)
- [Content](#)
- [Usage](#)
- [Examples](#)
- [Observable Attributes](#)

(Automatically generated from BeanInfo)

Generated Object

A `javax.swing.JTextArea` is returned, unless the user passes in a subclass of `JTextArea` as the value argument, in which case the value argument is returned.

Attributes

Declared in `javax.swing.JTextArea`

- **columns** <int> the number of columns preferred for display
- **lineWrap** <boolean> should lines be wrapped
- **rows** <int> the number of rows preferred for display
- **tabSize** <int> the number of characters to expand tabs to
- **wrapStyleWord** <boolean> should wrapping occur at word boundaries

- **lineCount** <int>

Declared in `javax.swing.text.JTextComponent`

- **caret** <Caret> the caret used to select/navigate
- **caretColor** <Color> the color used to render the caret
- **caretPosition** <int> the caret position
- **disabledTextColor** <Color> color used to render disabled text
- **document** <Document> the text document model
- **dragEnabled** <boolean> determines whether automatic drag handling is enabled
- **editable** <boolean> specifies if the text can be edited
- **focusAccelerator** <char> accelerator character used to grab focus
- **highlighter** <Highlighter> object responsible for background highlights
- **keymap** <Keymap> set of key event to action bindings to use
- **margin** <Insets> desired space between the border and text area
- **selectedTextColor** <Color> color used to render selected text
- **selectionColor** <Color> color used to render selection background
- **selectionEnd** <int> ending location of the selection.
- **selectionStart** <int> starting location of the selection.
- **text** <String> the text of this component

- **UI** <TextUI>
- **inputMethodRequests** <InputMethodRequests>
- **navigationFilter** <NavigationFilter>
- **preferredScrollableViewportSize** <Dimension>
- **scrollableTracksViewportHeight** <boolean>
- **scrollableTracksViewportWidth** <boolean>
- **selectedText** <String>

Declared in `javax.swing.JComponent`

- **autoscrolls** <boolean> Determines if this component automatically scrolls its contents when dragged.
- **border** <Border> The component's border.

- **componentPopupMenu** <JPopupMenu> Popup to show
- **debugGraphicsOptions** <int> Diagnostic options for graphics operations.
- **inheritsPopupMenu** <boolean> Whether or not the JPopupMenu is inherited
- **inputVerifier** <InputVerifier> The component's input verifier.
- **opaque** <boolean> The component's opacity
- **toolTipText** <String> The text to display in a tool tip.
- **transferHandler** <TransferHandler> Mechanism for transfer of data to and from the component
- **verifyInputWhenFocusTarget** <boolean> Whether the Component verifies input before accepting focus.
- **UIClassID** <String>
- **accessibleContext** <AccessibleContext>
- **actionMap** <ActionMap>
- **doubleBuffered** <boolean>
- **graphics** <Graphics>
- **height** <int>
- **managingFocus** <boolean>
- **nextFocusableComponent** <Component>
- **optimizedDrawingEnabled** <boolean>
- **paintingTile** <boolean>
- **registeredKeyStrokes** <KeyStroke[]>
- **requestFocusEnabled** <boolean>
- **rootPane** <JRootPane>
- **topLevelAncestor** <Container>
- **validateRoot** <boolean>
- **visibleRect** <Rectangle>
- **width** <int>
- **x** <int>
- **y** <int>

Declared in java.awt.Container

- **alignmentX** <float>
- **alignmentY** <float>
- **componentCount** <int>
- **components** <Component[]>
- **focusCycleRoot** <boolean>
- **focusTraversalPolicy** <FocusTraversalPolicy>
- **focusTraversalPolicyProvider** <boolean>
- **focusTraversalPolicySet** <boolean>
- **insets** <Insets>
- **layout** <LayoutManager>
- **maximumSize** <Dimension>
- **minimumSize** <Dimension>
- **preferredSize** <Dimension>

Declared in java.awt.Component

- **background** <Color>
- **enabled** <boolean>
- **focusable** <boolean>
- **font**
- **foreground** <Color>
- **name** <String>
- **visible** <boolean>

Events

Declared in javax.swing.text.JTextComponent

- **caretUpdate** (CaretEvent) - part of CaretListener

Declared in javax.swing.JComponent

- **vetoableChange** (PropertyChangeEvent) - part of VetoableChangeListener
- **ancestorMoved** (AncestorEvent) - part of AncestorListener
- **ancestorAdded** (AncestorEvent) - part of AncestorListener
- **ancestorRemoved** (AncestorEvent) - part of AncestorListener

Declared in java.awt.Container

- **componentAdded** (ContainerEvent) - part of ContainerListener
- **componentRemoved** (ContainerEvent) - part of ContainerListener

Declared in java.awt.Component

- **keyPressed** (KeyEvent) - part of KeyListener
- **keyReleased** (KeyEvent) - part of KeyListener
- **keyTyped** (KeyEvent) - part of KeyListener
- **componentHidden** (ComponentEvent) - part of ComponentListener
- **componentMoved** (ComponentEvent) - part of ComponentListener
- **componentResized** (ComponentEvent) - part of ComponentListener
- **componentShown** (ComponentEvent) - part of ComponentListener
- **hierarchyChanged** (HierarchyEvent) - part of HierarchyListener
- **mouseClicked** (MouseEvent) - part of MouseListener
- **mouseEntered** (MouseEvent) - part of MouseListener
- **mouseExited** (MouseEvent) - part of MouseListener
- **mousePressed** (MouseEvent) - part of MouseListener
- **mouseReleased** (MouseEvent) - part of MouseListener
- **mouseDragged** (MouseEvent) - part of MouseMotionListener
- **mouseMoved** (MouseEvent) - part of MouseMotionListener
- **propertyChange** (PropertyChangeEvent) - part of PropertyChangeListener
- **ancestorMoved** (HierarchyEvent) - part of HierarchyBoundsListener
- **ancestorResized** (HierarchyEvent) - part of HierarchyBoundsListener
- **focusGained** (FocusEvent) - part of FocusListener
- **focusLost** (FocusEvent) - part of FocusListener
- **mouseWheelMoved** (MouseEvent) - part of MouseWheelListener
- **caretPositionChanged** (InputMethodEvent) - part of InputMethodListener
- **inputMethodTextChanged** (InputMethodEvent) - part of InputMethodListener

Content

Usage

Examples

Observable Attributes

- alignmentX
- alignmentY
- background
- border
- caret
- caretColor
- component
- componentCount
- componentPopupMenu
- components
- containerListeners
- disabledTextColor
- document
- editable
- enabled

- focusAccelerator
- focusCycleRoot
- focusTraversalKeys
- focusTraversalPolicy
- focusTraversalPolicyProvider
- focusTraversalPolicySet
- focusable
- font
- foreground
- highlighter
- inheritsPopupMenu
- inputVerifier
- insets
- keymap
- layout
- lineWrap
- margin
- maximumSize
- minimumSize
- opaque
- preferredSize
- selectedTextColor
- selectionColor
- tabSize
- transferHandler
- verifyInputWhenFocusTarget
- wrapStyleWord

SwingBuilder.textField

This page last changed on Nov 01, 2007 by [shemnon](#).

Generated Object

A `javax.swing.JTextField` is returned, unless the user passes in a subclass of `JTextField` as the value argument, in which case the value argument is returned.

Value Argument

The value argument can be either a `JTextField`, or a `String`. If the value argument is a string it is treated as though it were passed in as the text attribute.

Attributes

See also: [JComponent](#)

Declared in JTextField

- `action` <Action> the Action instance connected with this ActionEvent source
- `columns` <int> the number of columns preferred for display
- `horizontalAlignment` <int> Set the field alignment to LEFT, CENTER, RIGHT, LEADING (the default) or TRAILING
- `scrollOffset` <int> scrollOffset

Declared in javax.swing.text.JTextComponent

- `caret` <javax.swing.text.Caret> the caret used to select/navigate
- `caretColor` <Color> the color used to render the caret
- `caretPosition` <int> the caret position
- `disabledTextColor` <Color> color used to render disabled text
- `document` <javax.swing.text.Document> the text document model
- `editable` <boolean> specifies if the text can be edited
- `focusAccelerator` <char> accelerator character used to grab focus
- `highlighter` <javax.swing.text.Highlighter> object responsible for background highlights
- `margin` <Insets> desired space between the border and text area
- `selectedText` <String> selectedText
- `selectedTextColor` <Color> color used to render selected text
- `selectionColor` <Color> color used to render selection background
- `selectionEnd` <int> ending location of the selection.
- `selectionStart` <int> starting location of the selection.
- `text` <String> the text of this component

Content

No child content is accepted in a `textField`.

Usage

The action connected to the `textField` is usually fired when the 'Enter' key is pressed by the user when the `textField` has keyboard focus.

Examples

```
//TODO
```

Observable Attributes

- `text` - via syntetic observation
- `caret`

- caretColor
- disabledTextColor
- document
- dragEnabled
- editable
- focusAccelerator
- highlighter
- keymap
- margin
- selectedTextColor
- selectionColor

SwingBuilder.textPane

This page last changed on Mar 21, 2008 by [shemnon](#).

- [Generated Object](#)
- [Attributes](#)
- [Events](#)
- [Content](#)
- [Usage](#)
- [Examples](#)
- [Observable Attributes](#)

(Automatically generated from BeanInfo)

Generated Object

A `javax.swing.JTextPane` is returned, unless the user passes in a subclass of `JTextPane` as the value argument, in which case the value argument is returned.

Attributes

Declared in `javax.swing.JTextPane`

- **characterAttributes** <AttributeSet>
- **inputAttributes** <MutableAttributeSet>
- **logicalStyle** <Style>
- **paragraphAttributes** <AttributeSet>
- **styledDocument** <StyledDocument>

Declared in `javax.swing.JEditorPane`

- **contentType** <String> the type of content
- **editorKit** <EditorKit> the currently installed kit for handling content
- **page** <URL> the URL used to set content

Declared in `javax.swing.text.JTextComponent`

- **caret** <Caret> the caret used to select/navigate
- **caretColor** <Color> the color used to render the caret
- **caretPosition** <int> the caret position
- **disabledTextColor** <Color> color used to render disabled text
- **document** <Document> the text document model
- **dragEnabled** <boolean> determines whether automatic drag handling is enabled
- **editable** <boolean> specifies if the text can be edited
- **focusAccelerator** <char> accelerator character used to grab focus
- **highlighter** <Highlighter> object responsible for background highlights
- **keymap** <Keymap> set of key event to action bindings to use
- **margin** <Insets> desired space between the border and text area
- **selectedTextColor** <Color> color used to render selected text
- **selectionColor** <Color> color used to render selection background
- **selectionEnd** <int> ending location of the selection.
- **selectionStart** <int> starting location of the selection.
- **text** <String> the text of this component

- **UI** <TextUI>
- **inputMethodRequests** <InputMethodRequests>
- **navigationFilter** <NavigationFilter>
- **preferredScrollableViewportSize** <Dimension>
- **scrollableTracksViewportHeight** <boolean>
- **scrollableTracksViewportWidth** <boolean>
- **selectedText** <String>

Declared in javax.swing.JComponent

- **autoscrolls** <boolean> Determines if this component automatically scrolls its contents when dragged.
- **border** <Border> The component's border.
- **componentPopupMenu** <JPopupMenu> Popup to show
- **debugGraphicsOptions** <int> Diagnostic options for graphics operations.
- **inheritsPopupMenu** <boolean> Whether or not the JPopupMenu is inherited
- **inputVerifier** <InputVerifier> The component's input verifier.
- **opaque** <boolean> The component's opacity
- **toolTipText** <String> The text to display in a tool tip.
- **transferHandler** <TransferHandler> Mechanism for transfer of data to and from the component
- **verifyInputWhenFocusTarget** <boolean> Whether the Component verifies input before accepting focus.

- **UIClassID** <String>
- **accessibleContext** <AccessibleContext>
- **actionMap** <ActionMap>
- **doubleBuffered** <boolean>
- **graphics** <Graphics>
- **height** <int>
- **managingFocus** <boolean>
- **nextFocusableComponent** <Component>
- **optimizedDrawingEnabled** <boolean>
- **paintingTile** <boolean>
- **registeredKeyStrokes** <KeyStroke[]>
- **requestFocusEnabled** <boolean>
- **rootPane** <JRootPane>
- **topLevelAncestor** <Container>
- **validateRoot** <boolean>
- **visibleRect** <Rectangle>
- **width** <int>
- **x** <int>
- **y** <int>

Declared in java.awt.Container

- **alignmentX** <float>
- **alignmentY** <float>
- **componentCount** <int>
- **components** <Component[]>
- **focusCycleRoot** <boolean>
- **focusTraversalPolicy** <FocusTraversalPolicy>
- **focusTraversalPolicyProvider** <boolean>
- **focusTraversalPolicySet** <boolean>
- **insets** <Insets>
- **layout** <LayoutManager>
- **maximumSize** <Dimension>
- **minimumSize** <Dimension>
- **preferredSize** <Dimension>

Declared in java.awt.Component

- **background** <Color>
- **enabled** <boolean>
- **focusable** <boolean>
- **font**
- **foreground** <Color>
- **name** <String>
- **visible** <boolean>

Events

Declared in `javax.swing.JEditorPane`

- **hyperlinkUpdate** (HyperlinkEvent) - part of HyperlinkListener

Declared in `javax.swing.text.JTextComponent`

- **caretUpdate** (CaretEvent) - part of CaretListener

Declared in `javax.swing.JComponent`

- **vetoableChange** (PropertyChangeEvent) - part of VetoableChangeListener
- **ancestorMoved** (AncestorEvent) - part of AncestorListener
- **ancestorAdded** (AncestorEvent) - part of AncestorListener
- **ancestorRemoved** (AncestorEvent) - part of AncestorListener

Declared in `java.awt.Container`

- **componentAdded** (ContainerEvent) - part of ContainerListener
- **componentRemoved** (ContainerEvent) - part of ContainerListener

Declared in `java.awt.Component`

- **keyPressed** (KeyEvent) - part of KeyListener
- **keyReleased** (KeyEvent) - part of KeyListener
- **keyTyped** (KeyEvent) - part of KeyListener
- **componentHidden** (ComponentEvent) - part of ComponentListener
- **componentMoved** (ComponentEvent) - part of ComponentListener
- **componentResized** (ComponentEvent) - part of ComponentListener
- **componentShown** (ComponentEvent) - part of ComponentListener
- **hierarchyChanged** (HierarchyEvent) - part of HierarchyListener
- **mouseClicked** (MouseEvent) - part of MouseListener
- **mouseEntered** (MouseEvent) - part of MouseListener
- **mouseExited** (MouseEvent) - part of MouseListener
- **mousePressed** (MouseEvent) - part of MouseListener
- **mouseReleased** (MouseEvent) - part of MouseListener
- **mouseDragged** (MouseEvent) - part of MouseMotionListener
- **mouseMoved** (MouseEvent) - part of MouseMotionListener
- **propertyChange** (PropertyChangeEvent) - part of PropertyChangeListener
- **ancestorMoved** (HierarchyEvent) - part of HierarchyBoundsListener
- **ancestorResized** (HierarchyEvent) - part of HierarchyBoundsListener
- **focusGained** (FocusEvent) - part of FocusListener
- **focusLost** (FocusEvent) - part of FocusListener
- **mouseWheelMoved** (MouseEvent) - part of MouseWheelListener
- **caretPositionChanged** (InputMethodEvent) - part of InputMethodListener
- **inputMethodTextChanged** (InputMethodEvent) - part of InputMethodListener

Content

Usage

Examples

Observable Attributes

- alignmentX
- alignmentY
- background
- border

- caret
- caretColor
- component
- componentCount
- componentPopupMenu
- components
- containerListeners
- disabledTextColor
- document
- editable
- editorKit
- enabled
- focusAccelerator
- focusCycleRoot
- focusTraversalKeys
- focusTraversalPolicy
- focusTraversalPolicyProvider
- focusTraversalPolicySet
- focusable
- font
- foreground
- highlighter
- inheritsPopupMenu
- inputVerifier
- insets
- keymap
- layout
- margin
- maximumSize
- minimumSize
- opaque
- page
- preferredSize
- selectedTextColor
- selectionColor
- transferHandler
- verifyInputWhenFocusTarget

SwingBuilder.titledBorder

This page last changed on Mar 21, 2008 by [shemnon](#).

- [Generated Object](#)
- [Attributes](#)
- [Events](#)
- [Content](#)
- [Usage](#)
- [Examples](#)

(Automatically generated from BeanInfo)

Generated Object

A `javax.swing.border.TitledBorder` is returned, unless the user passes in a subclass of `TitledBorder` as the value argument, in which case the value argument is returned.

Attributes

Declared in `javax.swing.border.TitledBorder`

- **border** <Border>
- **title** <String>
- **titleColor** <Color>
- **titleFont**
- **titleJustification** <int>
- **titlePosition** <int>

Declared in `javax.swing.border.AbstractBorder`

- **borderOpaque** <boolean>

Events

Content

Usage

Examples

SwingBuilder.toggleButton

This page last changed on Mar 21, 2008 by [shemnon](#).

- [Generated Object](#)
- [Attributes](#)
- [Events](#)
- [Content](#)
- [Usage](#)
- [Examples](#)
- [Observable Attributes](#)

(Automatically generated from BeanInfo)

Generated Object

A `javax.swing.JToggleButton` is returned, unless the user passes in a subclass of `JToggleButton` as the value argument, in which case the value argument is returned.

Attributes

Declared in `javax.swing.AbstractButton`

- **UI** <ButtonUI> The UI object that implements the LookAndFeel.
- **action** <Action> the Action instance connected with this ActionEvent source
- **borderPainted** <boolean> Whether the border should be painted.
- **contentAreaFilled** <boolean> Whether the button should paint the content area or leave it transparent.
- **disabledIcon** <Icon> The disabled icon for the button.
- **disabledSelectedIcon** <Icon> The disabled selection icon for the button.
- **displayedMnemonicIndex** <int> the index into the String to draw the keyboard character mnemonic at
- **focusPainted** <boolean> Whether focus should be painted
- **horizontalAlignment** <int> The horizontal alignment of the icon and text.
- **horizontalTextPosition** <int> The horizontal position of the text relative to the icon.
- **icon** <Icon> The button's default icon
- **iconTextGap** <int> If both the icon and text properties are set, this property defines the space between them.
- **label** <String> Replace by `setText(text)`
- **margin** <Insets> The space between the button's border and the label.
- **mnemonic** <int> the keyboard character mnemonic
- **model** <ButtonModel> Model that the Button uses.
- **pressedIcon** <Icon> The pressed icon for the button.
- **rolloverEnabled** <boolean> Whether rollover effects should be enabled.
- **rolloverIcon** <Icon> The rollover icon for the button.
- **rolloverSelectedIcon** <Icon> The rollover selected icon for the button.
- **selectedIcon** <Icon> The selected icon for the button.
- **text** <String> The button's text.
- **verticalAlignment** <int> The vertical alignment of the icon and text.
- **verticalTextPosition** <int> The vertical position of the text relative to the icon.

- **actionCommand** <String>
- **multiClickThreshold** <long>
- **selected** <boolean>
- **selectedObjects** <Object[]>

Declared in `javax.swing.JComponent`

- **autoscrolls** <boolean> Determines if this component automatically scrolls its contents when dragged.
- **border** <Border> The component's border.
- **componentPopupMenu** <JPopupMenu> Popup to show
- **debugGraphicsOptions** <int> Diagnostic options for graphics operations.

- **inheritsPopupMenu** <boolean> Whether or not the JPopupMenu is inherited
- **inputVerifier** <InputVerifier> The component's input verifier.
- **opaque** <boolean> The component's opacity
- **toolTipText** <String> The text to display in a tool tip.
- **transferHandler** <TransferHandler> Mechanism for transfer of data to and from the component
- **verifyInputWhenFocusTarget** <boolean> Whether the Component verifies input before accepting focus.
- **UIClassID** <String>
- **accessibleContext** <AccessibleContext>
- **actionMap** <ActionMap>
- **doubleBuffered** <boolean>
- **graphics** <Graphics>
- **height** <int>
- **managingFocus** <boolean>
- **nextFocusableComponent** <Component>
- **optimizedDrawingEnabled** <boolean>
- **paintingTile** <boolean>
- **registeredKeyStrokes** <KeyStroke[]>
- **requestFocusEnabled** <boolean>
- **rootPane** <JRootPane>
- **topLevelAncestor** <Container>
- **validateRoot** <boolean>
- **visibleRect** <Rectangle>
- **width** <int>
- **x** <int>
- **y** <int>

Declared in java.awt.Container

- **alignmentX** <float>
- **alignmentY** <float>
- **componentCount** <int>
- **components** <Component[]>
- **focusCycleRoot** <boolean>
- **focusTraversalPolicy** <FocusTraversalPolicy>
- **focusTraversalPolicyProvider** <boolean>
- **focusTraversalPolicySet** <boolean>
- **insets** <Insets>
- **layout** <LayoutManager>
- **maximumSize** <Dimension>
- **minimumSize** <Dimension>
- **preferredSize** <Dimension>

Declared in java.awt.Component

- **background** <Color>
- **enabled** <boolean>
- **focusable** <boolean>
- **font**
- **foreground** <Color>
- **name** <String>
- **visible** <boolean>

Events

Declared in javax.swing.AbstractButton

- **itemStateChanged** (ItemEvent) - part of ItemListener
- **actionPerformed** (ActionEvent) - part of ActionListener
- **stateChanged** (ChangeEvent) - part of ChangeListener

Declared in javax.swing.JComponent

- **vetoableChange** (PropertyChangeEvent) - part of VetoableChangeListener
- **ancestorMoved** (AncestorEvent) - part of AncestorListener
- **ancestorAdded** (AncestorEvent) - part of AncestorListener
- **ancestorRemoved** (AncestorEvent) - part of AncestorListener

Declared in java.awt.Container

- **componentAdded** (ContainerEvent) - part of ContainerListener
- **componentRemoved** (ContainerEvent) - part of ContainerListener

Declared in java.awt.Component

- **keyPressed** (KeyEvent) - part of KeyListener
- **keyReleased** (KeyEvent) - part of KeyListener
- **keyTyped** (KeyEvent) - part of KeyListener
- **componentHidden** (ComponentEvent) - part of ComponentListener
- **componentMoved** (ComponentEvent) - part of ComponentListener
- **componentResized** (ComponentEvent) - part of ComponentListener
- **componentShown** (ComponentEvent) - part of ComponentListener
- **hierarchyChanged** (HierarchyEvent) - part of HierarchyListener
- **mouseClicked** (MouseEvent) - part of MouseListener
- **mouseEntered** (MouseEvent) - part of MouseListener
- **mouseExited** (MouseEvent) - part of MouseListener
- **mousePressed** (MouseEvent) - part of MouseListener
- **mouseReleased** (MouseEvent) - part of MouseListener
- **mouseDragged** (MouseEvent) - part of MouseMotionListener
- **mouseMoved** (MouseEvent) - part of MouseMotionListener
- **propertyChange** (PropertyChangeEvent) - part of PropertyChangeListener
- **ancestorMoved** (HierarchyEvent) - part of HierarchyBoundsListener
- **ancestorResized** (HierarchyEvent) - part of HierarchyBoundsListener
- **focusGained** (FocusEvent) - part of FocusListener
- **focusLost** (FocusEvent) - part of FocusListener
- **mouseWheelMoved** (MouseEvent) - part of MouseWheelListener
- **caretPositionChanged** (InputMethodEvent) - part of InputMethodListener
- **inputMethodTextChanged** (InputMethodEvent) - part of InputMethodListener

Content

Usage

Examples

Observable Attributes

- UI
- action
- alignmentX
- alignmentY
- background
- border
- borderPainted
- component
- componentCount
- componentPopupMenu
- components
- containerListeners
- contentAreaFilled
- disabledIcon
- disabledSelectedIcon

- displayedMnemonicIndex
- enabled
- focusCycleRoot
- focusPainted
- focusTraversalKeys
- focusTraversalPolicy
- focusTraversalPolicyProvider
- focusTraversalPolicySet
- focusable
- font
- foreground
- horizontalAlignment
- horizontalTextPosition
- icon
- iconTextGap
- inheritsPopupMenu
- inputVerifier
- insets
- label
- layout
- margin
- maximumSize
- minimumSize
- mnemonic
- model
- opaque
- preferredSize
- pressedIcon
- rolloverEnabled
- rolloverIcon
- rolloverSelectedIcon
- selectedIcon
- text
- transferHandler
- verifyInputWhenFocusTarget
- verticalAlignment
- verticalTextPosition

SwingBuilder.toolbar

This page last changed on Mar 21, 2008 by [shemnon](#).

- [Generated Object](#)
- [Attributes](#)
- [Events](#)
- [Content](#)
- [Usage](#)
- [Examples](#)
- [Observable Attributes](#)

(Automatically generated from BeanInfo)

Generated Object

A `javax.swing.JToolBar` is returned, unless the user passes in a subclass of `JToolBar` as the value argument, in which case the value argument is returned.

Attributes

Declared in `javax.swing.JToolBar`

- **UI** `<ToolBarUI>` The UI object that implements the Component's LookAndFeel.
- **borderPainted** `<boolean>` Does the tool bar paint its borders?
- **floatable** `<boolean>` Can the tool bar be made to float by the user?
- **margin** `<Insets>` The margin between the tool bar's border and contents
- **orientation** `<int>` The current orientation of the tool bar
- **rollover** `<boolean>` Will draw rollover button borders in the toolbar.

Declared in `javax.swing.JComponent`

- **autoscrolls** `<boolean>` Determines if this component automatically scrolls its contents when dragged.
- **border** `<Border>` The component's border.
- **componentPopupMenu** `<JPopupMenu>` Popup to show
- **debugGraphicsOptions** `<int>` Diagnostic options for graphics operations.
- **inheritsPopupMenu** `<boolean>` Whether or not the JPopupMenu is inherited
- **inputVerifier** `<InputVerifier>` The component's input verifier.
- **opaque** `<boolean>` The component's opacity
- **toolTipText** `<String>` The text to display in a tool tip.
- **transferHandler** `<TransferHandler>` Mechanism for transfer of data to and from the component
- **verifyInputWhenFocusTarget** `<boolean>` Whether the Component verifies input before accepting focus.

- **UIClassID** `<String>`
- **accessibleContext** `<AccessibleContext>`
- **actionMap** `<ActionMap>`
- **doubleBuffered** `<boolean>`
- **graphics** `<Graphics>`
- **height** `<int>`
- **managingFocus** `<boolean>`
- **nextFocusableComponent** `<Component>`
- **optimizedDrawingEnabled** `<boolean>`
- **paintingTile** `<boolean>`
- **registeredKeyStrokes** `<KeyStroke[]>`
- **requestFocusEnabled** `<boolean>`
- **rootPane** `<JRootPane>`
- **topLevelAncestor** `<Container>`
- **validateRoot** `<boolean>`
- **visibleRect** `<Rectangle>`
- **width** `<int>`
- **x** `<int>`

- **y** <int>

Declared in `java.awt.Container`

- **alignmentX** <float>
- **alignmentY** <float>
- **componentCount** <int>
- **components** <Component[]>
- **focusCycleRoot** <boolean>
- **focusTraversalPolicy** <FocusTraversalPolicy>
- **focusTraversalPolicyProvider** <boolean>
- **focusTraversalPolicySet** <boolean>
- **insets** <Insets>
- **layout** <LayoutManager>
- **maximumSize** <Dimension>
- **minimumSize** <Dimension>
- **preferredSize** <Dimension>

Declared in `java.awt.Component`

- **background** <Color>
- **enabled** <boolean>
- **focusable** <boolean>
- **font**
- **foreground** <Color>
- **name** <String>
- **visible** <boolean>

Events

Declared in `javax.swing.JComponent`

- **vetoableChange** (PropertyChangeEvent) - part of VetoableChangeListener
- **ancestorMoved** (AncestorEvent) - part of AncestorListener
- **ancestorAdded** (AncestorEvent) - part of AncestorListener
- **ancestorRemoved** (AncestorEvent) - part of AncestorListener

Declared in `java.awt.Container`

- **componentAdded** (ContainerEvent) - part of ContainerListener
- **componentRemoved** (ContainerEvent) - part of ContainerListener

Declared in `java.awt.Component`

- **keyPressed** (KeyEvent) - part of KeyListener
- **keyReleased** (KeyEvent) - part of KeyListener
- **keyTyped** (KeyEvent) - part of KeyListener
- **componentHidden** (ComponentEvent) - part of ComponentListener
- **componentMoved** (ComponentEvent) - part of ComponentListener
- **componentResized** (ComponentEvent) - part of ComponentListener
- **componentShown** (ComponentEvent) - part of ComponentListener
- **hierarchyChanged** (HierarchyEvent) - part of HierarchyListener
- **mouseClicked** (MouseEvent) - part of MouseListener
- **mouseEntered** (MouseEvent) - part of MouseListener
- **mouseExited** (MouseEvent) - part of MouseListener
- **mousePressed** (MouseEvent) - part of MouseListener
- **mouseReleased** (MouseEvent) - part of MouseListener
- **mouseDragged** (MouseEvent) - part of MouseMotionListener
- **mouseMoved** (MouseEvent) - part of MouseMotionListener
- **propertyChange** (PropertyChangeEvent) - part of PropertyChangeListener
- **ancestorMoved** (HierarchyEvent) - part of HierarchyBoundsListener
- **ancestorResized** (HierarchyEvent) - part of HierarchyBoundsListener

- **focusGained** (FocusEvent) - part of FocusListener
- **focusLost** (FocusEvent) - part of FocusListener
- **mouseWheelMoved** (MouseEvent) - part of MouseWheelListener
- **caretPositionChanged** (InputMethodEvent) - part of InputMethodListener
- **inputMethodTextChanged** (InputMethodEvent) - part of InputMethodListener

Content

Usage

Examples

Observable Attributes

- UI
- alignmentX
- alignmentY
- background
- border
- borderPainted
- component
- componentCount
- componentPopupMenu
- components
- containerListeners
- enabled
- floatable
- focusCycleRoot
- focusTraversalKeys
- focusTraversalPolicy
- focusTraversalPolicyProvider
- focusTraversalPolicySet
- focusable
- font
- foreground
- inheritsPopupMenu
- inputVerifier
- insets
- layout
- margin
- maximumSize
- minimumSize
- opaque
- orientation
- preferredSize
- rollover
- transferHandler
- verifyInputWhenFocusTarget

SwingBuilder.tr

This page last changed on Mar 21, 2008 by [shemnon](#).

- [Generated Object](#)
- [Attributes](#)
- [Events](#)
- [Content](#)
- [Usage](#)
- [Examples](#)

(Automatically generated from BeanInfo)

Generated Object

A `groovy.swing.impl.TableLayoutRow` is returned, unless the user passes in a subclass of `TableLayoutRow` as the value argument, in which case the value argument is returned.

Attributes

Declared in `groovy.swing.impl.TableLayoutRow`

- `rowIndex` <int>

Events

Content

Usage

Examples

SwingBuilder.tree

This page last changed on Mar 21, 2008 by [shemnon](#).

- [Generated Object](#)
- [Attributes](#)
- [Events](#)
- [Content](#)
- [Usage](#)
- [Examples](#)
- [Observable Attributes](#)

(Automatically generated from BeanInfo)

Generated Object

A `javax.swing.JTree` is returned, unless the user passes in a subclass of `JTree` as the value argument, in which case the value argument is returned.

Attributes

Declared in `javax.swing.JTree`

- **UI** <TreeUI> The UI object that implements the Component's LookAndFeel.
- **anchorSelectionPath** <TreePath> Anchor selection path
- **cellEditor** <TreeCellEditor> The cell editor. A null value implies the tree cannot be edited.
- **cellRenderer** <TreeCellRenderer> The `TreeCellRenderer` that will be used to draw each cell.
- **dragEnabled** <boolean> determines whether automatic drag handling is enabled
- **editable** <boolean> Whether the tree is editable.
- **expandsSelectedPaths** <boolean> Indicates whether changes to the selection should make the parent of the path visible.
- **invokesStopCellEditing** <boolean> Determines what happens when editing is interrupted, selecting another node in the tree, a change in the tree's data, or some other means.
- **largeModel** <boolean> Whether the UI should use a large model.
- **leadSelectionPath** <TreePath> Lead selection path
- **model** <TreeModel> The `TreeModel` that will provide the data.
- **rootVisible** <boolean> Whether or not the root node from the `TreeModel` is visible.
- **rowHeight** <int> The height of each cell.
- **scrollsOnExpand** <boolean> Indicates if a node descendant should be scrolled when expanded.
- **selectionModel** <TreeSelectionModel> The tree's selection model.
- **showsRootHandles** <boolean> Whether the node handles are to be displayed.
- **toggleClickCount** <int> Number of clicks before a node will expand/collapse.
- **visibleRowCount** <int> The number of rows that are to be displayed.

- **editing** <boolean>
- **editingPath** <TreePath>
- **fixedRowHeight** <boolean>
- **lastSelectedPathComponent** <Object>
- **leadSelectionRow** <int>
- **maxSelectionRow** <int>
- **minSelectionRow** <int>
- **preferredScrollableViewportSize** <Dimension>
- **rowCount** <int>
- **scrollableTracksViewportHeight** <boolean>
- **scrollableTracksViewportWidth** <boolean>
- **selectionCount** <int>
- **selectionEmpty** <boolean>
- **selectionPath** <TreePath>
- **selectionPaths** <TreePath[]>
- **selectionRows** <int[]>

Declared in javax.swing.JComponent

- **autoscrolls** <boolean> Determines if this component automatically scrolls its contents when dragged.
- **border** <Border> The component's border.
- **componentPopupMenu** <JPopupMenu> Popup to show
- **debugGraphicsOptions** <int> Diagnostic options for graphics operations.
- **inheritsPopupMenu** <boolean> Whether or not the JPopupMenu is inherited
- **inputVerifier** <InputVerifier> The component's input verifier.
- **opaque** <boolean> The component's opacity
- **toolTipText** <String> The text to display in a tool tip.
- **transferHandler** <TransferHandler> Mechanism for transfer of data to and from the component
- **verifyInputWhenFocusTarget** <boolean> Whether the Component verifies input before accepting focus.

- **UIClassID** <String>
- **accessibleContext** <AccessibleContext>
- **actionMap** <ActionMap>
- **doubleBuffered** <boolean>
- **graphics** <Graphics>
- **height** <int>
- **managingFocus** <boolean>
- **nextFocusableComponent** <Component>
- **optimizedDrawingEnabled** <boolean>
- **paintingTile** <boolean>
- **registeredKeyStrokes** <KeyStroke[]>
- **requestFocusEnabled** <boolean>
- **rootPane** <JRootPane>
- **topLevelAncestor** <Container>
- **validateRoot** <boolean>
- **visibleRect** <Rectangle>
- **width** <int>
- **x** <int>
- **y** <int>

Declared in java.awt.Container

- **alignmentX** <float>
- **alignmentY** <float>
- **componentCount** <int>
- **components** <Component[]>
- **focusCycleRoot** <boolean>
- **focusTraversalPolicy** <FocusTraversalPolicy>
- **focusTraversalPolicyProvider** <boolean>
- **focusTraversalPolicySet** <boolean>
- **insets** <Insets>
- **layout** <LayoutManager>
- **maximumSize** <Dimension>
- **minimumSize** <Dimension>
- **preferredSize** <Dimension>

Declared in java.awt.Component

- **background** <Color>
- **enabled** <boolean>
- **focusable** <boolean>
- **font**
- **foreground** <Color>
- **name** <String>
- **visible** <boolean>

Events

Declared in javax.swing.JTree

- **treeCollapsed** (TreeExpansionEvent) - part of TreeExpansionListener
- **treeExpanded** (TreeExpansionEvent) - part of TreeExpansionListener
- **valueChanged** (TreeSelectionEvent) - part of TreeSelectionListener
- **treeWillCollapse** (TreeExpansionEvent) - part of TreeWillExpandListener
- **treeWillExpand** (TreeExpansionEvent) - part of TreeWillExpandListener

Declared in javax.swing.JComponent

- **vetoableChange** (PropertyChangeEvent) - part of VetoableChangeListener
- **ancestorMoved** (AncestorEvent) - part of AncestorListener
- **ancestorAdded** (AncestorEvent) - part of AncestorListener
- **ancestorRemoved** (AncestorEvent) - part of AncestorListener

Declared in java.awt.Container

- **componentAdded** (ContainerEvent) - part of ContainerListener
- **componentRemoved** (ContainerEvent) - part of ContainerListener

Declared in java.awt.Component

- **keyPressed** (KeyEvent) - part of KeyListener
- **keyReleased** (KeyEvent) - part of KeyListener
- **keyTyped** (KeyEvent) - part of KeyListener
- **componentHidden** (ComponentEvent) - part of ComponentListener
- **componentMoved** (ComponentEvent) - part of ComponentListener
- **componentResized** (ComponentEvent) - part of ComponentListener
- **componentShown** (ComponentEvent) - part of ComponentListener
- **hierarchyChanged** (HierarchyEvent) - part of HierarchyListener
- **mouseClicked** (MouseEvent) - part of MouseListener
- **mouseEntered** (MouseEvent) - part of MouseListener
- **mouseExited** (MouseEvent) - part of MouseListener
- **mousePressed** (MouseEvent) - part of MouseListener
- **mouseReleased** (MouseEvent) - part of MouseListener
- **mouseDragged** (MouseEvent) - part of MouseMotionListener
- **mouseMoved** (MouseEvent) - part of MouseMotionListener
- **propertyChange** (PropertyChangeEvent) - part of PropertyChangeListener
- **ancestorMoved** (HierarchyEvent) - part of HierarchyBoundsListener
- **ancestorResized** (HierarchyEvent) - part of HierarchyBoundsListener
- **focusGained** (FocusEvent) - part of FocusListener
- **focusLost** (FocusEvent) - part of FocusListener
- **mouseWheelMoved** (MouseEvent) - part of MouseWheelListener
- **caretPositionChanged** (InputMethodEvent) - part of InputMethodListener
- **inputMethodTextChanged** (InputMethodEvent) - part of InputMethodListener

Content

Usage

Examples

Observable Attributes

- UI
- alignmentX
- alignmentY
- anchorSelectionPath

- background
- border
- cellEditor
- cellRenderer
- component
- componentCount
- componentPopupMenu
- components
- containerListeners
- editable
- enabled
- expandsSelectedPaths
- focusCycleRoot
- focusTraversalKeys
- focusTraversalPolicy
- focusTraversalPolicyProvider
- focusTraversalPolicySet
- focusable
- font
- foreground
- inheritsPopupMenu
- inputVerifier
- insets
- invokesStopCellEditing
- largeModel
- layout
- leadSelectionPath
- maximumSize
- minimumSize
- model
- opaque
- preferredSize
- rootVisible
- rowHeight
- scrollsOnExpand
- selectionModel
- showsRootHandles
- toggleClickCount
- transferHandler
- verifyInputWhenFocusTarget
- visibleRowCount

SwingBuilder.viewport

This page last changed on Mar 21, 2008 by [shemnon](#).

- [Generated Object](#)
- [Attributes](#)
- [Events](#)
- [Content](#)
- [Usage](#)
- [Examples](#)
- [Observable Attributes](#)

(Automatically generated from BeanInfo)

Generated Object

A `javax.swing.JViewport` is returned, unless the user passes in a subclass of `JViewport` as the value argument, in which case the value argument is returned.

Attributes

Declared in `javax.swing.JViewport`

- **UI** <ViewportUI>
- **backingStoreEnabled** <boolean>
- **extentSize** <Dimension>
- **scrollMode** <int>
- **view** <Component>
- **viewPosition** <Point>
- **viewRect** <Rectangle>
- **viewSize** <Dimension>

Declared in `javax.swing.JComponent`

- **autoscrolls** <boolean> Determines if this component automatically scrolls its contents when dragged.
- **border** <Border> The component's border.
- **componentPopupMenu** <JPopupMenu> Popup to show
- **debugGraphicsOptions** <int> Diagnostic options for graphics operations.
- **inheritsPopupMenu** <boolean> Whether or not the JPopupMenu is inherited
- **inputVerifier** <InputVerifier> The component's input verifier.
- **opaque** <boolean> The component's opacity
- **toolTipText** <String> The text to display in a tool tip.
- **transferHandler** <TransferHandler> Mechanism for transfer of data to and from the component
- **verifyInputWhenFocusTarget** <boolean> Whether the Component verifies input before accepting focus.

- **UIClassID** <String>
- **accessibleContext** <AccessibleContext>
- **actionMap** <ActionMap>
- **doubleBuffered** <boolean>
- **graphics** <Graphics>
- **height** <int>
- **managingFocus** <boolean>
- **nextFocusableComponent** <Component>
- **optimizedDrawingEnabled** <boolean>
- **paintingTile** <boolean>
- **registeredKeyStrokes** <KeyStroke[]>
- **requestFocusEnabled** <boolean>
- **rootPane** <JRootPane>
- **topLevelAncestor** <Container>
- **validateRoot** <boolean>
- **visibleRect** <Rectangle>

- **width** <int>
- **x** <int>
- **y** <int>

Declared in `java.awt.Container`

- **alignmentX** <float>
- **alignmentY** <float>
- **componentCount** <int>
- **components** <Component[]>
- **focusCycleRoot** <boolean>
- **focusTraversalPolicy** <FocusTraversalPolicy>
- **focusTraversalPolicyProvider** <boolean>
- **focusTraversalPolicySet** <boolean>
- **insets** <Insets>
- **layout** <LayoutManager>
- **maximumSize** <Dimension>
- **minimumSize** <Dimension>
- **preferredSize** <Dimension>

Declared in `java.awt.Component`

- **background** <Color>
- **enabled** <boolean>
- **focusable** <boolean>
- **font**
- **foreground** <Color>
- **name** <String>
- **visible** <boolean>

Events

Declared in `javax.swing.JViewport`

- **stateChanged** (ChangeEvent) - part of ChangeListener

Declared in `javax.swing.JComponent`

- **vetoableChange** (PropertyChangeEvent) - part of VetoableChangeListener
- **ancestorMoved** (AncestorEvent) - part of AncestorListener
- **ancestorAdded** (AncestorEvent) - part of AncestorListener
- **ancestorRemoved** (AncestorEvent) - part of AncestorListener

Declared in `java.awt.Container`

- **componentAdded** (ContainerEvent) - part of ContainerListener
- **componentRemoved** (ContainerEvent) - part of ContainerListener

Declared in `java.awt.Component`

- **keyPressed** (KeyEvent) - part of KeyListener
- **keyReleased** (KeyEvent) - part of KeyListener
- **keyTyped** (KeyEvent) - part of KeyListener
- **componentHidden** (ComponentEvent) - part of ComponentListener
- **componentMoved** (ComponentEvent) - part of ComponentListener
- **componentResized** (ComponentEvent) - part of ComponentListener
- **componentShown** (ComponentEvent) - part of ComponentListener
- **hierarchyChanged** (HierarchyEvent) - part of HierarchyListener
- **mouseClicked** (MouseEvent) - part of MouseListener
- **mouseEntered** (MouseEvent) - part of MouseListener
- **mouseExited** (MouseEvent) - part of MouseListener
- **mousePressed** (MouseEvent) - part of MouseListener

- **mouseReleased** (MouseEvent) - part of MouseListener
- **mouseDragged** (MouseEvent) - part of MouseMotionListener
- **mouseMoved** (MouseEvent) - part of MouseMotionListener
- **propertyChange** (PropertyChangeEvent) - part of PropertyChangeListener
- **ancestorMoved** (HierarchyEvent) - part of HierarchyBoundsListener
- **ancestorResized** (HierarchyEvent) - part of HierarchyBoundsListener
- **focusGained** (FocusEvent) - part of FocusListener
- **focusLost** (FocusEvent) - part of FocusListener
- **mouseWheelMoved** (MouseWheelEvent) - part of MouseWheelListener
- **caretPositionChanged** (InputMethodEvent) - part of InputMethodListener
- **inputMethodTextChanged** (InputMethodEvent) - part of InputMethodListener

Content

Usage

Examples

Observable Attributes

- UI
- UIClassID
- accessibleContext
- alignmentX
- alignmentY
- background
- backingStoreEnabled
- border
- changeListeners
- component
- componentCount
- componentPopupMenu
- components
- containerListeners
- enabled
- extentSize
- focusCycleRoot
- focusTraversalKeys
- focusTraversalPolicy
- focusTraversalPolicyProvider
- focusTraversalPolicySet
- focusable
- font
- foreground
- inheritsPopupMenu
- inputVerifier
- insets
- layout
- maximumSize
- minimumSize
- opaque
- preferredSize
- scrollMode
- transferHandler
- verifyInputWhenFocusTarget
- view
- viewPosition
- viewRect
- viewSize

SwingBuilder.widget

This page last changed on Mar 21, 2008 by [shemnon](#).

- [Generated Object](#)
- [Attributes](#)
- [Events](#)
- [Content](#)
- [Usage](#)
- [Examples](#)
- [Observable Attributes](#)

(Automatically generated from BeanInfo)

Generated Object

A java.awt.Component is returned, unless the user passes in a subclass of Component as the value argument, in which case the value argument is returned.

Attributes

Declared in java.awt.Component

- **background** <Color>
- **enabled** <boolean>
- **focusable** <boolean>
- **font**
- **foreground** <Color>
- **name** <String>
- **visible** <boolean>

Events

Declared in java.awt.Component

- **keyPressed** (KeyEvent) - part of KeyListener
- **keyReleased** (KeyEvent) - part of KeyListener
- **keyTyped** (KeyEvent) - part of KeyListener
- **componentHidden** (ComponentEvent) - part of ComponentListener
- **componentMoved** (ComponentEvent) - part of ComponentListener
- **componentResized** (ComponentEvent) - part of ComponentListener
- **componentShown** (ComponentEvent) - part of ComponentListener
- **hierarchyChanged** (HierarchyEvent) - part of HierarchyListener
- **mouseClicked** (MouseEvent) - part of MouseListener
- **mouseEntered** (MouseEvent) - part of MouseListener
- **mouseExited** (MouseEvent) - part of MouseListener
- **mousePressed** (MouseEvent) - part of MouseListener
- **mouseReleased** (MouseEvent) - part of MouseListener
- **mouseDragged** (MouseEvent) - part of MouseMotionListener
- **mouseMoved** (MouseEvent) - part of MouseMotionListener
- **propertyChange** (PropertyChangeEvent) - part of PropertyChangeListener
- **ancestorMoved** (HierarchyEvent) - part of HierarchyBoundsListener
- **ancestorResized** (HierarchyEvent) - part of HierarchyBoundsListener
- **focusGained** (FocusEvent) - part of FocusListener
- **focusLost** (FocusEvent) - part of FocusListener
- **mouseWheelMoved** (MouseEvent) - part of MouseWheelListener
- **caretPositionChanged** (InputMethodEvent) - part of InputMethodListener
- **inputMethodTextChanged** (InputMethodEvent) - part of InputMethodListener

Content

Usage

Examples

Observable Attributes

- background
- focusable
- font
- foreground

SwingBuilder.window

This page last changed on Mar 21, 2008 by [shemnon](#).

- [Generated Object](#)
- [Attributes](#)
- [Events](#)
- [Content](#)
- [Usage](#)
- [Examples](#)
- [Observable Attributes](#)

(Automatically generated from BeanInfo)

Generated Object

A `javax.swing.JWindow` is returned, unless the user passes in a subclass of `JWindow` as the value argument, in which case the value argument is returned.

Attributes

Declared in `javax.swing.JWindow`

- **contentPane** <Container> The client area of the window where child components are normally inserted.
- **glassPane** <Component> A transparent pane used for menu rendering.
- **layeredPane** <JLayeredPane> The pane which holds the various window layers.
- **rootPane** <JRootPane> the `RootPane` object for this window.

Declared in `java.awt.Window`

- **accessibleContext** <AccessibleContext>
- **active** <boolean>
- **alwaysOnTop** <boolean>
- **bufferStrategy** <BufferStrategy>
- **cursor** <Cursor>
- **focusCycleRootAncestor** <Container>
- **focusOwner** <Component>
- **focusableWindow** <boolean>
- **focusableWindowState** <boolean>
- **focused** <boolean>
- **graphicsConfiguration** <GraphicsConfiguration>
- **inputContext** <InputContext>
- **locale** <Locale>
- **locationByPlatform** <boolean>
- **locationRelativeTo** <Component>
- **mostRecentFocusOwner** <Component>
- **ownedWindows** <Window[]>
- **owner** <Window>
- **showing** <boolean>
- **toolkit** <Toolkit>
- **warningString** <String>

Declared in `java.awt.Container`

- **alignmentX** <float>
- **alignmentY** <float>
- **componentCount** <int>
- **components** <Component[]>
- **focusCycleRoot** <boolean>
- **focusTraversalPolicy** <FocusTraversalPolicy>
- **focusTraversalPolicyProvider** <boolean>
- **focusTraversalPolicySet** <boolean>

- **insets** <Insets>
- **layout** <LayoutManager>
- **maximumSize** <Dimension>
- **minimumSize** <Dimension>
- **preferredSize** <Dimension>

Declared in `java.awt.Component`

- **background** <Color>
- **enabled** <boolean>
- **focusable** <boolean>
- **font**
- **foreground** <Color>
- **name** <String>
- **visible** <boolean>

Events

Declared in `java.awt.Window`

- **windowStateChanged** (WindowEvent) - part of WindowStateListener
- **windowGainedFocus** (WindowEvent) - part of WindowFocusListener
- **windowLostFocus** (WindowEvent) - part of WindowFocusListener
- **windowActivated** (WindowEvent) - part of WindowListener
- **windowClosed** (WindowEvent) - part of WindowListener
- **windowClosing** (WindowEvent) - part of WindowListener
- **windowDeactivated** (WindowEvent) - part of WindowListener
- **windowDeiconified** (WindowEvent) - part of WindowListener
- **windowIconified** (WindowEvent) - part of WindowListener
- **windowOpened** (WindowEvent) - part of WindowListener

Declared in `java.awt.Container`

- **componentAdded** (ContainerEvent) - part of ContainerListener
- **componentRemoved** (ContainerEvent) - part of ContainerListener

Declared in `java.awt.Component`

- **keyPressed** (KeyEvent) - part of KeyListener
- **keyReleased** (KeyEvent) - part of KeyListener
- **keyTyped** (KeyEvent) - part of KeyListener
- **componentHidden** (ComponentEvent) - part of ComponentListener
- **componentMoved** (ComponentEvent) - part of ComponentListener
- **componentResized** (ComponentEvent) - part of ComponentListener
- **componentShown** (ComponentEvent) - part of ComponentListener
- **hierarchyChanged** (HierarchyEvent) - part of HierarchyListener
- **mouseClicked** (MouseEvent) - part of MouseListener
- **mouseEntered** (MouseEvent) - part of MouseListener
- **mouseExited** (MouseEvent) - part of MouseListener
- **mousePressed** (MouseEvent) - part of MouseListener
- **mouseReleased** (MouseEvent) - part of MouseListener
- **mouseDragged** (MouseEvent) - part of MouseMotionListener
- **mouseMoved** (MouseEvent) - part of MouseMotionListener
- **propertyChange** (PropertyChangeEvent) - part of PropertyChangeListener
- **ancestorMoved** (HierarchyEvent) - part of HierarchyBoundsListener
- **ancestorResized** (HierarchyEvent) - part of HierarchyBoundsListener
- **focusGained** (FocusEvent) - part of FocusListener
- **focusLost** (FocusEvent) - part of FocusListener
- **mouseWheelMoved** (MouseEvent) - part of MouseWheelListener
- **caretPositionChanged** (InputMethodEvent) - part of InputMethodListener
- **inputMethodTextChanged** (InputMethodEvent) - part of InputMethodListener

Content

Usage

Examples

Observable Attributes

- accessibleContext
- active
- alignmentX
- alignmentY
- alwaysOnTop
- background
- bufferStrategy
- component
- componentCount
- components
- containerListeners
- cursor
- focusCycleRoot
- focusCycleRootAncestor
- focusOwner
- focusTraversalKeys
- focusTraversalPolicy
- focusTraversalPolicyProvider
- focusTraversalPolicySet
- focusable
- focusableWindow
- focusableWindowState
- focused
- font
- foreground
- graphicsConfiguration
- inputContext
- insets
- layout
- locale
- locationByPlatform
- locationRelativeTo
- maximumSize
- minimumSize
- mostRecentFocusOwner
- ownedWindows
- owner
- preferredSize
- showing
- toolkit
- warningString
- windowFocusListeners
- windowListeners
- windowStateListeners

Categorical Widget List

This page last changed on Oct 23, 2007 by [shemnon](#).

Root Windows

- dialog
- frame
- window

Embeddable Windows

- optionPane
- fileChooser
- colorChooser

Containers

- box
- desktopPane
 - internalFrame
- layeredPane
- panel
- scrollPane
 - viewport
- splitPane
- tabbedPane
- toolBar
- container - returns value argument or container attribute

Menus

- menuBar
- popupMenu
- menu
- menuItem
- checkBoxMenuItem
- radioButtonMenuItem

Widgets

- button
- checkBox
- comboBox
- editorPane
- formattedTextField
- label
- list
- passwordField
- progressBar
- radioButton
- scrollbar
- separator
- slider
- spinner
- table
- textArea
- textPane
- textField
- toggleButton
- tree
- widget - returns value argument or widget attribute

Borders

- compoundBorder
- emptyBorder
- etchedBorder
- lineBorder
- loweredBevelBorder
- loweredEtchedBorder - alias for etchedBorder
- matteBorder
- raisedBevelBorder
- raisedEtchedBorder
- titledBorder

Layouts

- BorderLayout
- BorderLayout
- CardLayout
- FlowLayout
- GridBagLayout
 - GridBagConstraints
 - gbc - alias for GridBagConstraints
- GridLayout
- OverlayLayout
- SpringLayout
- Box
 - hbox
 - hglue
 - hstrut
 - vbox
 - vglue
 - vstrut
 - glue
 - rigidArea

Models

- BoundedRangeModel
- ButtonGroup
- SpinnerDateModel
- SpinnerListModel
- SpinnerNumberModel
- TableModel
 - TableColumn
 - PropertyColumn
 - ClosureColumn

Other

- Action
- Actions
- ImageIcon
- Map

Extending Swing Builder

This page last changed on May 08, 2007 by [shemnon](#).

While SwingBuilder comes with almost all of the standard Swing widgets, sometimes you need to add custom or extended components. There are several ways to accomplish this.

Use a Pass-Through Element

SwingBuilder has two 'magic' elements that pass through the value argument or the named attribute to the parent container. The `widget` element has been in Groovy since 1.0. New in Groovy 1.1Beta2 is the `container` element. Currently they are identical in behavior and should be used mostly to increase code readability: elements that can contain children should use `container` while `widget` elements should contain no children. (in a future build this restriction may be enforced at the builder level).

To use the `widget` or `container` elements you pass in the desired custom widget or custom container object as the value argument or the `widget:` or `container:` attributes respectively.

```
swing.frame() {
  container(new MyCustomDocingPanel(), constraints:BorderLayout.CENTER) {
  widget(new CustomMappingComponent())
  }
  container(container:new CustomOutlookBar(), constraints:BorderLayout.WEST) {
  widget(widget:new MyCustomButton())
  }
}
```

Value Argument Replacement (new in 1.1Beta2)

Most widgets accept a widget of the appropriate type in the value argument of the swing builder element. If your extended component extends a common swing widget type you can supply an instance of that component in the value argument.

```
swing.frame() {
  button(new MyCustomButton("custom constructor"), enabled:false)
}
```

Register a Bean Factory (new in 1.1Beta2)

If your custom component follows the JavaBeans specification, specifically having a no-argument public constructor, then you can register your component directly with the SwingBuilder and use it as a first class element. To do this call the `registerBeanFactory(String, Class)` method with the desired element name and Bean class.

```
swing.registerBeanFactory('magicButton', MagicButton.class)
swing.frame() {
  magicButton("It's Magical!")
}
```

Register a Custom Factory (new in 1.1Beta2)

Sometimes you will need greater interaction with the supplied values in the SwingBuilder, or you want to accomplish richer things with the supplied arguments. In this case you can register a custom factory. Custom factories implement `groovy.swing.factory.Factory` and are registered via the `registerFactory(String, Factory)` method.

All of the elements that do interesting things with their argument values and that need to access different constructors or lack no-argument constructors utilize this interface. Tricks such as accessing the Action constructors in the button type widgets, using the `javax.swing.Box` factory methods are two such real world examples.

```
// a bit of a goofy example, we forcefully make the button blue
```

```
swing.registerFactory('blueButton',
[newInstance:{builder, name, value, attrs ->
attrs.remove('color')
builder.button(value, color:Color.BLUE)}
] as groovy.swing.factory.Factory)

swing.frame() {
blueButton('I want to be red!', color:Color.RED)
}
```

SwingXBuilder

This page last changed on Dec 11, 2007 by [ecspike](#).

What is SwingX(SwingLabs)?

SwingX is the UI component library developed by Sun's SwingLabs. Many of the components used and developed in the "Filthy Rich Clients" and "Extreme GUI Makeover" presentations first make their mark in SwingLabs before making it to core Java. SwingX adds a lot of convenience features that originally one would have to make himself, such as TaskPanels, enhanced core components, glossy components, etc.

Can I use it with my application built using v1.0?

Yes... The SwingXBuilder subclasses the classic SwingBuilder so generally speaking you can just switch the declaration and everything SHOULD work. Please let me know if something from core is broken in SwingXBuilder. Any component that exists in both defaults to the SwingX version but can be accessed by adding the classicSwing property and setting its value to true.

How do I build it?

Checkout the package from SVN [here](#) .

Download

0.1.1 is compiled against the [SwingLabs 16 Sep 2007 build](#) a Make sure those jars are on your path, including the ones in the lib directory.

0.1.2 and 0.1.3 are using [SwingX 0.9 release build](#).

0.1.5 uses the [SwingX 0.9.1 release build](#), and ships with the Windows installer for Groovy 1.5.0.

[swingxbuilder-0.1.1.jar](#) (compatible with Groovy 1.1-beta-3)

[swingxbuilder-0.1.2.jar](#) (compatible with Groovy 1.1-rc-1)

[swingxbuilder-0.1.3.jar](#) (ships with Groovy 1.1-rc-2 windows installer)

[swingxbuilder-0.1.5.jar](#) (ships with Groovy 1.5 windows installer)

Effects

This page last changed on Aug 03, 2007 by [ecspike](#).

Effects are objects that can be added to Painters to modify the way they are drawn.

SwingX includes several built-in Effects for your use:

- GlowPathEffect - Draws a glow around the Painter.
- InnerGlowPathEffect - Draws a glow inside the Painter's shape.
- InnerShadowPathEffect - Draws a shadow inside the Painter's shape.
- NeonBorderEffect - Draws a multicolored border around the Painter interpolating between two colors.
- ShadowPathEffect - Draws a shadow around the Painter's shape.

With the exception of NeonBorderEffect, the other effects have no argument constructors.

<i>Java class name: NeonBorderEffect</i>	<i>SwingXBuilder node: neonBorderEffect</i>
Attribute	Expected Type
edgeColor	Color
centerColor	Color
effectWidth	Integer

Extending SwingXBuilder

This page last changed on Jul 30, 2007 by [ecspike](#).

Since the SwingXBuilder subclasses the SwingBuilder, the same operations apply to the SwingXBuilder.

New Features in SwingXBuilder

Shortcutting/Aliasing attribute names

This has actually been around for a while but I only spoke about it to my mentors and not you guys. Sometimes attribute names are a bit long to type. In this example pulled from one of the unit tests, we can see how to add an alias for any property on a component. During builder parsing, the names are changed to their explicit forms.

```
builder.addShortcut(CheckerboardPainter.class,"squareSize", "size")
builder.addShortcut(CheckerboardPainter.class,"lightPaint", "light")
builder.addShortcut(CheckerboardPainter.class,"darkPaint", "dark")
def cp = builder.checkerboardPainter(size:40.0d, light:Color.WHITE, dark:Color.RED)
```

Before you ask, I did play around a bit with the idea of aliasing the component names but that was a bit cumbersome.

NOTE: Be careful when aliasing properties, making sure the alias doesn't already exist as a property name. For example, foreground and foregroundPainter exist for some components.

Graphs

This page last changed on Aug 19, 2007 by [ecspike](#).

JXGraph allows you to plot functions on a graph. JXGraph in Java takes a Plot (usually an anonymous function) to plot a function. Because anonymous classes are not possible in Groovy, a new class, GroovyPlot, has been created that can take a closure and generate a Plot.

The graph node in SwingXBuilder adds a property *plots* that takes a multi-dimensional List as a parameter. The internal list has a Color component and a closure representing the plot. Here is an example of code plotting $\sin x$:

```
def swing = new SwingXBuilder()
def frame = swing.frame(size:[300,300]) {
graph(plots:[[Color.GREEN, {value -> Math.sin(value)}]])
}.show()
```

And here is the corresponding graph:

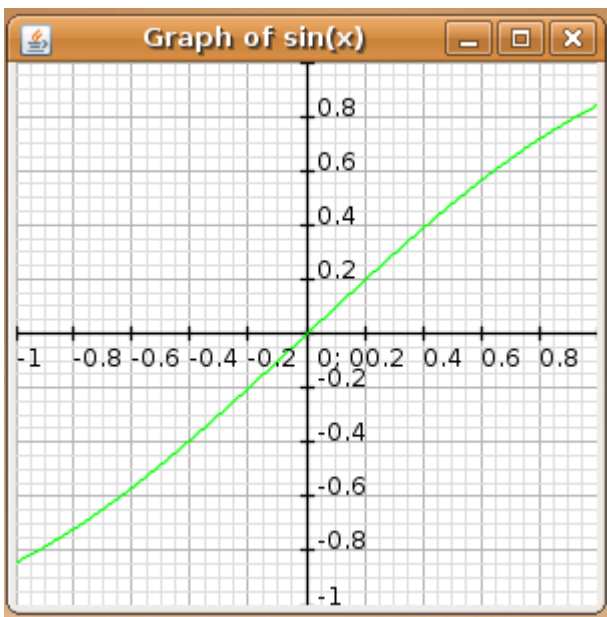

To graph, for instance, the cosine as well as the sine, the graph node signature would be:

```
graph(plots:[ [Color.GREEN, {value -> Math.sin(value)}], [Color.BLUE, { value ->
Math.cos(value)}] ] )
```

MultiSplitPane

This page last changed on Oct 16, 2007 by [jtbrown](#).

JXMultiSplitPane is somewhat of a hybrid component using MultiSplitLayout which is somewhere between GridLayout and GridBagLayout. MultiSplitLayout divides its components into horizontal or vertical Splits which are composed of Leaf components(which accept components) and Dividers(which separate them).

```
import groovy.swing.SwingXBuilder
def swing = new SwingXBuilder()
def frame = swing.frame(size:[300,300], title:'JXMultiSplitPane Demo') {
multiSplitPane() {
split() {
leaf(name:"left")
divider()
leaf(name:"right")
}
button(text:"Left Button", constraints:"left")
button(text:"Right Button", constraints:"right")
}
}.show()
```

Vertical splits can be created by setting the Split property *rowLayout* to false.

The code above produces the below layout:



Here is the code for a slightly more complex layout:

```
import groovy.swing.SwingXBuilder
def swing = new SwingXBuilder()
def frame = swing.frame(size:[300,300]) {
multiSplitPane() {
split() {
leaf(name:"left")
divider()
split(rowLayout:false) {
leaf(name:"top")
divider()
leaf(name:"bottom")
}
}
button(text:"Left Button", constraints:"left")
button(text:"Right Button", constraints:"right")
button(text:"Top Button", constraints:"top")
button(text:"Bottom Button", constraints:"bottom")
}
}.show()
```

That code produces the following layout:

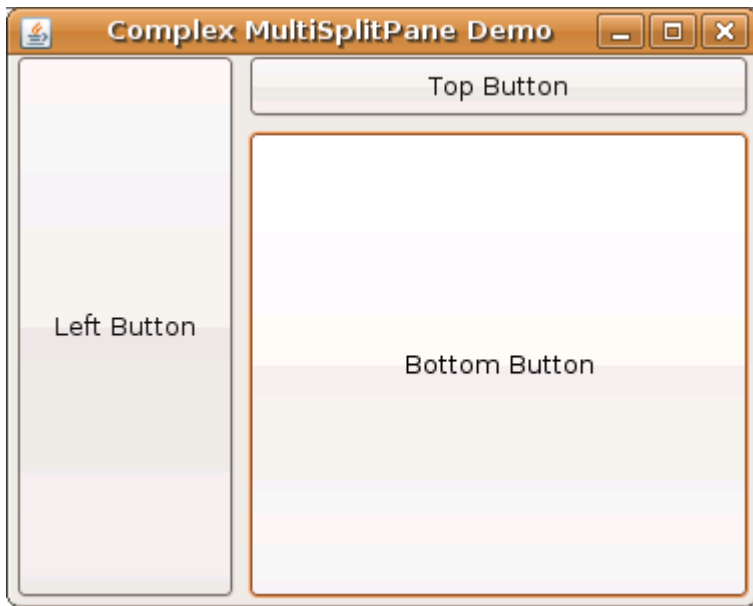

Painters

This page last changed on Aug 03, 2007 by [ecspike](#).

Painters are a sort of user interface delegate for drawing foregrounds and backgrounds. SwingX includes some built-in painters:

<i>Java class name:AlphaPainter</i>	<i>SwingXBuilder node: alphaPainter</i>
Attribute	Expected Type
alpha	float
painters	ArrayList<Painter> or Painter[]
<i>Java class name:BusyPainter</i>	<i>SwingXBuilder node: busyPainter</i>
Attribute	Expected Type
barLength	float
barWidth	float
baseColor	Color
<i>Java class name:CapsulePainter</i>	<i>SwingXBuilder node: capsulePainter</i>
Attribute	Expected Type
portion	CapsulePainter.Portion
<i>Java class name:CheckerboardPainter</i>	<i>SwingXBuilder node: checkerboardPainter</i>
Attribute	Expected Type
squareSize	float
lightPaint	Color
darkPaint	Color
<i>Java class name:ImagePainter</i>	<i>SwingXBuilder node: imagePainter</i>
Attribute	Expected Type
image	BufferedImage
url	URL
style	AbstractAreaPainter.Style
horizontal	AbstractLayoutPainter.HorizontalAlignment
vertical	AbstractLayoutPainter.VerticalAlignment
<i>Java class name:ImagePainter</i>	<i>SwingXBuilder node: imagePainter</i>
Attribute	Expected Type
width	integer
height	integer

rounded	boolean
roundHeight	integer
roundWidth	integer
fillPaint	Color
<i>Java class name:PinStripePainter</i>	<i>SwingXBuilder node: pinStripePainter</i>
Attribute	Expected Type
paint	Paint
angle	double
stripeWidth	double
spacing	double
<i>Java class name:MattePainter</i>	<i>SwingXBuilder node: mattePainter</i>
Attribute	Expected Type
paint	Paint
paintStretched	boolean
<i>Java class name:TextPainter</i>	<i>SwingXBuilder node: textPainter</i>
Attribute	Expected Type
font	Font
text	String
paint	Paint
<i>Java class name:GlossPainter</i>	<i>SwingXBuilder node: glossPainter</i>
Attribute	Expected Type
position	GlossPainter.GlossPosition
paint	Paint

CompoundPainter

CompoundPainter, as its name indicates, is a collection of other Painters. Order is important. CompoundPainters build from back to front. Here is an example of a CompoundPainter:

```
comp = swing.compoundPainter(clipPreserved:true) {
  rectanglePainter(borderWidth:3f, borderPaint:Color.BLACK,
  areaEffects:new GlowPathEffect(), roundHeight:40, roundWidth:40,
  insets: [3,3,3,3], paintStretched:true,style:AbstractAreaPainter.Style.FILLED,
  fillPaint:grad)
  pinStripePainter(paint:[204,0,0,36] as Color,angle:45, stripeWidth:8, spacing:8)
}
```

AlphaPainter is a CompoundPainter as well, adding an alpha value to a collection of Painters. CompoundPainter can take the painters attribute or you can enumerate the painters inside the closure.

Widgets and Common Attributes

This page last changed on Aug 09, 2007 by [ecspike](#).

Windows and Dialogs	
<i>Java class name:JXFrame</i>	<i>SwingXBuilder node: frame</i>
Attribute	Expected Type
title	String
layout	LayoutManager
size	Dimension or [x,y]
defaultCloseOperation	WindowConstants
<i>Java class name:JXPanel</i>	<i>SwingXBuilder node: panel</i>
Attribute	Expected Type
layout	LayoutManager
size	Dimension or [x,y]
alpha	float
<i>Java class name:JXTitledPanel</i>	<i>SwingXBuilder node: titledPanel</i>
Attribute	Expected Type
layout	LayoutManager
titleForeground	Color
titlePainter	Painter
title	String
size	Dimension or [x,y]
<i>Java class name:JXLoginDialog</i>	<i>SwingXBuilder node: loginDialog</i>
Attribute	Expected Type
title	String
modal	boolean
service	LoginService
<i>Java class name:JXCollapsiblePane</i>	<i>SwingXBuilder node: collapsiblePane</i>
Attribute	Expected Type
orientation	JXCollapsiblePane.Orientation
layout	LayoutManager
animated	boolean

collapsed	boolean
------------------	---------

Basic Components	
<i>Java class name: JXBusyLabel</i>	<i>SwingXBuilder node: busyLabel</i>
Attribute	Expected Type
busy	boolean
<i>Java class name: JXButton</i>	<i>SwingXBuilder node: button</i>
Attribute	Expected Type
text	String
icon	Icon
backgroundPainter	Painter
foregroundPainter	Painter
<i>Java class name: JXLabel</i>	<i>SwingXBuilder node: label</i>
Attribute	Expected Type
text	String
icon	Icon
horizontalAlignment	Painter
foregroundPainter	Painter
backgroundPainter	Painter
textRotation	double
lineWrap	boolean

Input Output

This page last changed on Apr 17, 2008 by [paulk_asert](#).

Groovy provides a number of [helper methods](#) for working with I/O. All of these work with standard Java Reader/Writer and InputStream/OutputStream and File and URL classes.

The use of closures allows resources to be processed ensuring that things are properly closed irrespective of exceptions. e.g. to iterate through each line of a file the following can be used...

```
new File("foo.txt").eachLine { line -> println(line) }
```

If for whatever reason the *println()* method were to throw an exception, the *eachLine()* method ensures that the file resource is correctly closed. Similarly if an exception occurs while reading, the resource will be closed too.

If you wish to use a reader/writer object or an input/output stream object there are helper methods to handle the resource for you via a closure - which will automatically close down any resource if an exception occurs. e.g.

```
new File("foo.txt").withReader { reader ->
while (true) {
def line = reader.readLine()
}
}
```

and

```
def fields = ["a":"1", "b":"2", "c":"3"]
new File("foo.ini").withWriter { out ->
fields.each() { key, value ->
out.writeLine("${key}=${value}")
}
}
```

Further Information

- [Streams, Readers, and Writers](#) for more on Input and Output.
- See also: [Process Management](#)

Integration

This page last changed on Nov 25, 2007 by [paulk_asert](#).

Integration

Looking to use Groovy with *[insert your favorite Java library here]*? We've got you covered! Groovy integrates very well (and sometimes greatly extends) a large number of existing Java libraries and tools:

-  [Ant Integration with Groovy](#)
-  [Bean Scripting Framework](#)
-  [Bridging the Gap Between Java and .NET with Groovy and Scriptom](#)
-  [Groovy and JMX](#)
-  [Groovy Maven Plugin](#)
-  [GUI Programming with Groovy](#)
-  [Integrating TPTP](#)
-  [Running Groovy on .NET 2.0 using IKVM](#)
-  [Unit Testing](#)
-  [Using JUnit 4 with Groovy](#)
-  [Using Other Testing Frameworks](#)
-  [Using Other XML Libraries](#)
-  [Using Spring Factories with Groovy](#)

Modules

Many "Modules" have been contributed to Groovy, most of which provide enhanced integration and extension for various tasks.

The following modules and contributions are currently available:

- [COM Scripting](#) — script Windows ActiveX and COM components with Groovy
- [Gant](#)
- [GFreeMarker](#) — an integration of the FreeMarker template engine for Groovy
- [Google Data Support](#) — makes using the Google Data APIs easier from within Groovy
- [Gram](#) — a simple xdoclet-like tool for processing doclet tags or Java 5 annotations
- [GraphicsBuilder](#) — GraphicsBuilder is a Groovy builder for Java 2D
- [Grapplet](#)
- [Griffon](#) — Dekstop Enhancements for Groovy
- [Groosh](#) — Provides a shell-like capability for handling external processes.
- [Groovy Jabber-RPC](#) — allows you to make XML-RPC calls using the Jabber protocol
- [Groovy Monkey](#) — is a dynamic scripting tool for the Eclipse Platform
- [Groovy SOAP](#) — create a SOAP server and make calls to remote SOAP servers using Groovy
- [GroovyLab](#) — Provides a domain specific language (DSL) for math engineering (matlab-like syntax).
- [GroovyRestlet](#) — Groovy DSL for constructing Restlet application
- [GroovySWT](#) — a wrapper around SWT, the eclipse Standard Widget Toolkit
- [GroovyWS](#) — GroovySOAP replacement that uses CXF and Java5 features
- [GSP](#) — means GroovyServer Pages, which is similar to JSP (JavaServer Pages)
- [GSQL](#) — supports easier access to databases using Groovy
- [JideBuilder](#) — JideBuilder is a Groovy builder for the open source [JIDE Common Layer](#)
- [Native Launcher](#) — a native program for launching groovy scripts
- [Windows NSIS-Installer](#) — a Windows-specific installer for Groovy
- [Windows Services](#) — framework for Groovy-based WinNT (Windows) Services
- [WingSBuilder](#) — WingsBuilder is a Groovy builder for the [wingS Framework](#)
- [XMLRPC](#) — allows you to create a local XML-RPC server and/or to make calls on remote XML-RPC servers

- [Grails](#) — a Groovy-based web framework inspired by Ruby on Rails
- [GORM](#) — the Grails Object-Relational Mapping persistence framework
- [GroovyPlugin](#) — A Groovy plugin for JSPWiki
- [Maven Plugin](#) — Integration of Groovy with [Maven](#)

Finally, if you don't see what you're looking for in the above list, remember – Groovy is Java! Just put that JAR in your classpath and start pounding at your keyboard as if it was Java.

JSR 223 Scripting with Groovy

This page last changed on Apr 22, 2008 by [paulk_asert](#).

Java 6 includes built-in support for [JSR 223: Scripting for the Java Platform](#) API classes. This framework can be used to host Script Engines in Java Applications. Numerous Scripting engines are [available](#).

Here is how you can use JSR 223 to talk to Groovy from Java:

```
// require(url:'https://scripting.dev.java.net', jar:'groovy-engine.jar')
import javax.script.ScriptEngine;
import javax.script.ScriptEngineManager;

public class CalcMain {
    public static void main(String[] args) throws Exception {
        ScriptEngineManager factory = new ScriptEngineManager();
        ScriptEngine engine = factory.getEngineByName("groovy");

        // basic example
        System.out.println(engine.eval("(1..10).sum()"));

        // example showing scripting variables
        engine.put("first", "HELLO");
        engine.put("second", "world");
        System.out.println(engine.eval("first.toLowerCase() + second.toUpperCase()"));
    }
}
```

The output is:

```
55
helloWORLD
```

To make this example work, add `groovy-engine.jar` from <https://scripting.dev.java.net/> to your CLASSPATH and run this program using Java 6.

This next example illustrates calling an invocable function:

```
// require(url:'https://scripting.dev.java.net', jar:'groovy-engine.jar')
import javax.script.ScriptEngine;
import javax.script.ScriptEngineManager;
import javax.script.Invocable;

public class FactMain {
    public static void main(String[] args) throws Exception {
        ScriptEngineManager factory = new ScriptEngineManager();
        ScriptEngine engine = factory.getEngineByName("groovy");
        String fact = "def factorial(n) { n == 1 ? 1 : n * factorial(n - 1) }";
        engine.eval(fact);
        Invocable inv = (Invocable) engine;
        Object[] params = { new Integer(5) };
        Object result = inv.invokeFunction("factorial", params);
        System.out.println(result);
    }
}
```

And when run, results in:

```
120
```

Groovy has many mechanisms for integration with Java, some of which provide richer options than available with JSR 223 (e.g. greater configurability and more security control). JSR 223 is recommended when you need to keep the choice of language used flexible and you don't require integration mechanisms not supported by JSR-223.

See also: [JSR-223 access to other JVM languages](#)

Logging

This page last changed on Dec 20, 2007 by opencoeli@gmail.com.

Logging in Groovy is based on the JDK logging facilities. Please read the JDK logging documentation if you are new to the topic.

In order to enable tracing of how Groovy calls MetaMethods, use the following settings:

in file `%JAVA_HOME%/jre/lib/logging.properties` or equivalent

- make sure your log handler is configured to show level 'FINER' at least, e.g.

```
java.util.logging.ConsoleHandler.level = ALL
```

- set MetaClass logging to 'FINER' at least, e.g.

```
groovy.lang.MetaClass.level = FINER
```

- set the appropriate Level for the Classes and optionally method names that you want to trace. The name for the appropriate logger starts with 'methodCalls' and optionally ends with the method name, e.g.

```
# trace all method calls
methodCalls.level = FINER
```

```
# trace method calls to the 'String' class
methodCalls.java.lang.String.level = FINER
```

```
# trace method calls to Object.println()
methodCalls.java.lang.Object.println.level = FINER
```

Example:

with tracing enabled for all method calls a Groovy command line script appears as follows (German locale)

```
$ groovy -e "println 'hi'"
13.09.2005 14:33:05 script_from_command_line run()
FEINER: called from MetaClass.invokeMethod
13.09.2005 14:33:05 script_from_command_line println('hi')
FEINER: called from MetaClass.invokeMethod
hi
```

LOG4J-GROOVY

There is one problem with loggers and groovy: Script name and line number is wrong. Groovy is using some bytecode magic which is confusing loggers. It is big problem for debugging, also message filtering by classes does not work.

There is simple patch for LOG4J which solve it. With it, LOG4J correctly shows file names and line numbers when invoked from Groovy. For more details check <http://www.kotek.net/projects/log4j-groovy>

Migration From Classic to JSR syntax

This page last changed on Sep 24, 2006 by paulk_asert.

Here is a checklist of changes you'll need to make to a Groovy classic codebase to ensure compatibility with the new Groovy JSR syntax.

Safe navigation

In Classic Groovy we used to use this syntax

```
class Person = { String name }
y = null
println "${y->name}"    // -> was the optional gpath operator with Classic Groovy syntax
```

Instead of using the arrow operator for safe navigation to avoid NullPointerException, we're now using the ?. operator

Now in the JSR we use this syntax

```
class Person = { String name }
def y = null
println "${y?.name}"    // Now, ?. is the optional gpath operator the new Groovy JSR
```

Parameter separator in the closure syntax

This allows us to use one single token for the separator between the closure in Classic Groovy we used to use this syntax

```
c1 = {a| ...}
c1 = {|a| ...}
```

Now in the JSR we use this syntax

```
def c1 = {a -> ...}
```

This allows us to use one single token for the separator between the closure parameters and the code in the closure which works with arbitrarily complex parameter list expressions and default values. e.g.

```
def c1 = {String x = "hey", int y = a|b -> println "Values are $x and $y"}
collection.each {int item -> println item}
```

Property keyword

- property keyword has been replaced with an annotation

```
class Foo {
  property foo
}

class Foo {
  @Property foo
}
```

Introduction of the 'def' keyword

- local variable declarations and fields currently need to be specified with 'def', a modifier, and/or a type. e.g.

```
def foo() {
  int x = 123
  y = 456 // classic
}
```

```

def foo() {
int x = 123
def y = 456 // JSR
}

class Foo {
telson // classic
int sharna
}
class Foo {
def telson // JSR
int sharna
}

```

(Syntactically, the new keyword 'def' acts for methods as a modifier like 'public'.)

For Scripts (as opposed to explicitly declared classes) the syntax is not changed, i.e. variable declarations without 'def' are still allowed, because those variables are automatically created in the script binding if they don't already exist.

Introduction of the 'as' keyword

- We can change types of objects with using the 'as' keyword, e.g.

```

def d0 = new Date(2005-1900, 5-1, 7) // in classic Groovy or Java
println d0

def d1 = [2005-1900, 5-1, 8] as Date // since jsr-01
println d1

Date d2 = [2005-1900, 5-1, 9] as Date // since jsr-01
println d2

Date d3 = [2005-1900, 5-1, 10] // since jsr-01
println d3

// def n0 = new int[] { 1, 3, 5, 6 } // Not work. This style is not supported since
groovy-1.0-jsr-01.

def n1 = [ 1, 3, 5, 7 ] as int[]
println n1.class
println n1.size()
println n1.length
println n1[0]
println n1[-1]

// int[] n2 = [ 2, 4, 6, 8,10 ] as int[] // work
int[] n2 = [ 2, 4, 6, 8, 10 ] // work
println n2.class
println n2.size()
println n2.length
println n2[0]
println n2[-1]

// String[] n3 = [ "a", "ab", "abc", "abcd", "abcde", "abcdef" ] as String[] // work
String[] n3 = [ "a", "ab", "abc", "abcd", "abcde", "abcdef" ] // work
println n3.class
println n3.size()
println n3.length
println n3[0]
println n3[-1]

```

Default access level of class members

The default access level for members of Groovy classes has changed from "public" to "protected"

Classic Groovy

```
class Foo {
  readMe_a;
  readMe_b
}
xyz = new Foo(readMe_a:"Hello",readMe_b:"World")
println xyz.readMe_a
println xyz.readMe_b
```

Now in JSR Groovy

```
class Foo {
  public readMe_a;
  def readMe_b //def is now required because of the "def keyword" change mentioned earlier
}
xyz = new Foo(readMe_a:"Hello",readMe_b:"World")
println xyz.readMe_a
println xyz.readMe_b //errors in JSR Groovy
```

Array creation

- no special array syntax. To make the language much cleaner, we now have a single syntax to work with lists and arrays in the JSR. Also note that we can now easily coerce from any collection or array to any array type

```
// classic
args = new String[] { "a", "b" }

// JSR
String[] args = ["a", "b"]
def x = [1, 2, 3] as int[]
long[] y = x
```

- **Be careful:** we don't support native multi-dimensional array creation right now.

float and double notation

- float and double literals cannot start with dot. So

```
x = .123 // classic
def x = 0.123 // JSR
```

This is to avoid ambiguity with things like ranges (1..2) and so forth

Explicit method pointer syntax

In classic Groovy you could access method pointers automatically if there was no java bean property of the given method name.

e.g.

```
// classic
methodPointer = System.out.println
methodPointer("Hello World")
```

This often caused confusion; as folks would use a property access to find something and get a method by accident (e.g. typo) and get confused. So now we make getting a method pointer explicit as follows

```
// JSR
def methodPointer = System.out.&println
methodPointer("Hello World")

def foo = ...
def p = foo.&bar

// lets call the bar method on the foo object
p(1, 2, 3)
```

No 'do ... while()' syntax as yet.

Due to ambiguity, we've not yet added support for do .. while to Groovy

'No Dumb Expression' rule

- no dumb expression rule, so we will catch dumb expressions (where a carriage return has broken the script). e.g.

```
def foo() {
  def x = 1
  +5 // dumb expression!
  return 8
}
```

Markup and builders

- markup / builders will change a little, but the classic syntax still applies. Not sure of the new syntax, but we'll have some kinda start/stop syntax to denote a markup block. Maybe a keyword, like

```
markup (builder) {
  // same stuff as before goes here
}

// or something like this
builder.{
  // same stuff as before goes here
}
```

Strings and GStrings

- single and double quote strings can only span one line; for multiple lines use triple quotes
- heredocs removal - they are kinda ugly anyway 😊. If you want to use them, just use treble quote instead

```
def foo = """
this
is
a very
long
string on many
lines
"""
```

- escaping of \$ inside GStrings must use \\$

```
println 'amount is $100'
// same as
println "amount is \$100"
```

- A new string definition is also supported which is escaping friendly, and thus particularly friendly for regex notation:

```

if ('abc' =~ /.../) {}
if ('abc' ==~ /.../) {}
'abc'.eachMatch(/.../) {}
['a', 'b', 'c'].grep(/a/)

switch('abc'){
case ~/.../ : whatever
}

assert 'EUOUAE'.matches(/^[aeiou]*$/)
assert 'EUOUAE' ==~ /^[aeiou]*$/
assert 'football'.replaceAll(/foo/, "Bar") == 'Bartball'

```

Assertions

- assert uses comma instead of colon to delimit the two parameter form of assertion statement

```

assert 0 <= value : "Must be non-negative" // classic
assert 0 <= value , "Must be non-negative" // JSR

```

return/break/continue semantics in closures

NOT YET IMPLEMENTED

- return/break/continue to behave inside closures like these statements work in other blocks (such as the block on a for() or while() loop. More details here

Integer division

Previously, in Groovy Classic, we used the backward slash as the integer division operator. This operator being confusing with escaping sequences was removed. So instead of \ please use the intdiv() method.

```
int result = 5 \ 3 // classic
```

Becomes

```
int result = 5.intdiv(3) // JSR
```

JDK5 for loop not supported

Groovy already supports a fair number of looping mechanisms, and in Classic, both for (... : ...) and for (... in ...) were supported. For the moment, only the for (... in ...) notation is allowed.

```

for (e : myList) { } // not allowed anymore
for (Element e : myList) { } // not allowed anymore
for (e in myList) { } // JSR
for (Element e in myList) { } // JSR

```

Exclusive range

The operator for creating ranges with the upper bound excluded from the range has changed.

Instead of:

```
range = 0...10
```

The syntax is now:

```
def range = 0..<10
```

Operators

This page last changed on Jan 03, 2008 by mjlachman@yahoo.com.

Operators

In general all operators [supported in Java](#) are identical in Groovy. Groovy goes a step further by allowing you to [customize behavior](#) of operators on Groovy types.

- [Arithmetic and Conditional Operators](#)
- [Collection-based Operators](#)
 - [Spread Operator \(*.\)](#)
- [Object-Related Operators](#)
- [Other Operators](#)
 - [Elvis Operator \(?:\)](#)
 - [Safe Navigation Operator \(?.\)](#)
- [Regular Expression Operators](#)

Arithmetic and Conditional Operators

See [Operator Overloading](#) for a list of the common operators that Groovy supports.

In addition, Groovy supports the ! (not) operator as follows:

```
def expression = false
assert !expression
```

For more details about how expressions are coerced to a boolean value, see: [Groovy Truth](#).

Collection-based Operators

Spread Operator (*.)

The Spread Operator is used to invoke an action on all items of an aggregate object. It is equivalent to calling the collect method like so:

```
parent*.action //equivalent to:
parent.collect{ child -> child?.action }
```

The spread operator may be used a method call or property access, and returns a list of the items returned from each child call. So you may effectively override the spread operator by implementing a custom collect method.

Object-Related Operators

- [invokeMethod and get/setProperty](#) (.)
- Method Reference (.&)
- 'as' - "manual coercion" - `asType(t)` method
- Groovy == (`equals()`) behavior.
 - "is" for identity
- The *instanceof* operator (as in Java)

Other Operators

- `getAt()` and `setAt()` for the subscript operator (e.g. `foo[1]`)
- Range Operator (..) - see [Collections#Collections-Ranges](#)
- Membership Operator (in)

Elvis Operator (?:)

The "Elvis operator" is a shortening of Java's [ternary operator](#). One instance of where this is handy is for returning a 'sensible default' value if an expression resolves to `false` or `null`. A simple example might look like this:

```
def gender = user.male ? "male" : "female" //traditional ternary operator usage
def displayName = user.name ?: "Anonymous" //more compact Elvis operator
```

Safe Navigation Operator (?.)

The Safe Navigation operator is used to avoid a `NullPointerException`. Typically when you have a reference to an object you might need to verify that it is not null before accessing methods or properties of the object. To avoid this, the safe navigation operator will simply return `null` instead of throwing an exception, like so:

```
def user = User.find( "admin" ) //this might be null if 'admin' does not exist
def streetName = user?.address?.street //streetName will be null if user or user.address is null
- no NPE thrown
```

Regular Expression Operators

- `find (=~)`
- `match (==~)`

For more details, see: [Regular Expressions](#)

Operator Overloading

This page last changed on Dec 22, 2007 by louis.martin@uqam.ca.

Groovy supports operator overloading which makes working with Numbers, Collections, Maps and various other data structures easier to use.

Various operators in Groovy are mapped onto regular Java method calls on objects. This allows you the developer to provide your own Java or Groovy objects which can take advantage of operator overloading. The following table describes the operators supported in Groovy and the methods they map to.

Operator	Method
<code>a + b</code>	<code>a.plus(b)</code>
<code>a - b</code>	<code>a.minus(b)</code>
<code>a * b</code>	<code>a.multiply(b)</code>
<code>a ** b</code>	<code>a.power(b)</code>
<code>a / b</code>	<code>a.div(b)</code>
<code>a % b</code>	<code>a.mod(b)</code>
<code>a b</code>	<code>a.or(b)</code>
<code>a & b</code>	<code>a.and(b)</code>
<code>a ^ b</code>	<code>a.xor(b)</code>
<code>a++</code> or <code>++a</code>	<code>a.next()</code>
<code>a--</code> or <code>--a</code>	<code>a.previous()</code>
<code>a[b]</code>	<code>a.getAt(b)</code>
<code>a[b] = c</code>	<code>a.putAt(b, c)</code>
<code>a << b</code>	<code>a.leftShift(b)</code>
<code>a >> b</code>	<code>a.rightShift(b)</code>
<code>switch(a) { case(b) : }</code>	<code>b.isCase(a)</code>
<code>~a</code>	<code>a.bitwiseNegate()</code>
<code>-a</code>	<code>a.negative()</code>
<code>+a</code>	<code>a.positive()</code>

Note that all the following comparison operators handle nulls gracefully avoiding the throwing of [java.lang.NullPointerException](#)

Operator	Method
<code>a == b</code>	<code>a.equals(b)</code> or <code>a.compareTo(b) == 0</code> **
<code>a != b</code>	<code>! a.equals(b)</code>

<code>a <=> b</code>	<code>a.compareTo(b)</code>
<code>a > b</code>	<code>a.compareTo(b) > 0</code>
<code>a >= b</code>	<code>a.compareTo(b) >= 0</code>
<code>a < b</code>	<code>a.compareTo(b) < 0</code>
<code>a <= b</code>	<code>a.compareTo(b) <= 0</code>

** Note: The `==` operator doesn't always exactly match the `.equals()` method. You can think of them as equivalent in most situations. In situations where two objects might be thought "equal" via normal Groovy "coercion" mechanisms, the `==` operator will report them as equal; the `.equals()` method will not do so if doing so would break the normal rules Java has around the equals method. Expect further improvements to Groovy over time to provide clearer, more powerful and more consistent behavior in this area.

Notes about operations

Also in Groovy comparison operators handle nulls gracefully. So that `a == b` will never throw a `NullPointerException` whether a or b or both are null.

```
def a = null
def b = "foo"

assert a != b
assert b != a
assert a == null
```

In addition when comparing numbers of different types the type coercion rules apply to convert numbers to the largest numeric type before the comparison. So the following is valid in Groovy

```
Byte a = 12
Double b = 10

assert a instanceof Byte
assert b instanceof Double

assert a > b
```

Process Management

This page last changed on Apr 18, 2008 by [blackdrag](#).

Executing External Processes

Groovy provides a simple way to execute command line processes. Simply write the command line as a string and call the `execute()` method. E.g., on a *nix machine (or a windows machine with appropriate *nix commands installed), you can execute this:

```
def process = "ls -l".execute()
println "Found text ${process.text}"
```

The `execute()` method returns a `java.lang.Process` instance which will subsequently allow the in/out/err streams to be processed and the exit value from the process to be inspected etc.

e.g. here is the same command as above but we will now process the resulting stream a line at a time

```
def process = "ls -l".execute()
process.in.eachLine { line -> println line }
```

in Groovy 1.5.5 the `eachLine` method is not available on `InputStream`. Earlier or later version will have that method. As an alternative you can use `process.in.newReader().eachLine { line -> println line }`

Remember that many commands are shell built-ins and need special handling. So if you want a listing of files in a directory on a windows machine and if you write

```
Process p = "dir".execute()
println "${p.text}"
```

you will get `IOException` saying "Cannot run program "dir": CreateProcess error=2, The system cannot find the file specified."

This is because "dir" is built-in to the windows shell (`cmd.exe`) and can't be run as a simple executable. Instead, you will need to write:

```
Process p = "cmd /c dir".execute()
println "${p.text}"
```

Also, because this functionality currently make use of `java.lang.Process` under the covers, the deficiencies of that class must currently be taken into consideration. In particular, the javadoc for this class says:

Because some native platforms only provide limited buffer size for standard input and output streams, failure to promptly write the input stream or read the output stream of the subprocess may cause the subprocess to block, and even deadlock

Because of this, Groovy provides some additional helper methods which make stream handling for processes easier.

Here is how to gobble all of the output (including the error stream output) from your process:

```
def p = "rm -rf */*.tmp".execute()
p.consumeProcessOutput()
```

There are also variations of `consumeProcessOutput` including one which takes output and error `StringBuffers`, another which takes output and error ditto for `InputStreams` and variations for `StringBuffers`, `Writers` and `InputStreams` which handle just the output stream or error stream individually. In addition, there is a `pipeTo` command (mapped to `'|'` to allow overloading) which lets the output stream of one process be fed into the input stream of another process.

Here are some examples of use:

```
proc1 = 'ls'.execute()
proc2 = 'tr -d o'.execute()
proc3 = 'tr -d e'.execute()
```

```

proc4 = 'tr -d i'.execute()
proc1 | proc2 | proc3 | proc4
proc4.waitFor()
if (proc4.exitValue())
print proc4.err.text
else
print proc4.text

def sout = new StringBuffer()
def serr = new StringBuffer()
proc2 = 'tr -d o'.execute()
proc3 = 'tr -d e'.execute()
proc4 = 'tr -d i'.execute()
proc4.consumeProcessOutput(sout, serr)
proc2 | proc3 | proc4
[proc2, proc3].each{ it.consumeProcessErrorStream(serr) }
proc2.withWriter { writer ->
writer << 'testfile.groovy'
}
proc4.waitForOrKill(1000)
println 'sout: ' + sout
println 'serr: ' + serr

def sout = new StringBuffer()
def serr = new StringBuffer()
proc1 = 'gzip -c'.execute()
proc2 = 'gunzip -c'.execute()
proc2.consumeProcessOutput(sout, serr)
proc1 | proc2
proc1.consumeProcessErrorStream(serr)
proc1.withWriter { writer ->
writer << 'test text'
}
proc2.waitForOrKill(1000)
println 'sout: ' + sout // => test text
println 'serr: ' + serr

def initialSize = 4096
def outputStream = new ByteArrayOutputStream(initialSize)
def errStream = new ByteArrayOutputStream(initialSize)
def proc = "ls.exe".execute()
proc.consumeProcessOutput(outputStream, errStream)
proc.waitFor()
println 'out:\n' + outputStream
println 'err:\n' + errStream

```

Further Information

See also:

- Cookbook Examples: [Executing External Processes From Groovy](#)
- PLEAC [Process Management](#) Examples
- A Groovy Shell called [Groosh](#) which builds upon Groovy's basic processing functionality

Processing XML

This page last changed on Apr 02, 2008 by [paulk_asert](#).

Processing existing XML

Groovy provides special XML processing support through the following classes:

Technology	When/Why to use	Requirements
XmlParser	supports GPath expressions for XML documents and allows updating	-
XmlSlurper	lower overheads than XmlParser due to lazy evaluation but only supports read operations	-
DOMCategory	low-level tree-based processing where you want some syntactic sugar	place <code>use(DOMCategory)</code> around your code

If you have special needs, you can use one of the many available Java APIs for XML processing. You should consult the documentation of individual APIs for the details, but some examples to get you started are included here:

Technology	When/Why to use	Requirements
DOM	low-level tree-based processing	-
SAX	event-based push-style parsing can be useful for streaming large files	-
StAX	event-based pull-style parsing can be useful for streaming large files	requires stax.jar
DOM4J	nicer syntax over DOM processing plus can be useful for large files if you use prune capability	requires dom4j.jar
XOM	nicer syntax over DOM processing plus a strong emphasis on compliancy	requires xom.jar
JDOM	nicer syntax over DOM processing	requires jdom.jar
XPath	use XPath expressions	requires Java 5+ or JAXP 1.3+ or xalan.jar or jaxen.jar
XSLT	when your transformation is more easily expressed using XSLT than code	-
XQuery	when your transformation is more easily expressed using XQuery than other alternatives	mxquery.jar or alternative

Creating new XML

The most commonly used approach for creating XML with Groovy is to use a builder, i.e. one of:

Technology	When/Why to use	Requirements
MarkupBuilder	supports Groovy's builder pattern with XML/HTML	-
StreamingMarkupBuilder	for larger files	-

Groovy also has some low-level helper classes you typically won't need to use directly but you may sometimes see in older examples of using XML with Groovy.

Technology	When/Why to use	Requirements
SAXBuilder	support class when using SAX	-
StreamingSAXBuilder	streaming version of SAXBuilder	-
DOMBuilder	support class when using DOM	-
StreamingDOMBuilder	streaming version of DOMBuilder	-

You can also use Java API's which support XML document creation:

Technology	When/Why to use	Requirements
DOM	low-level creation mechanism	-
JDOM	if you are an existing JDOM user	requires jdom.jar
DOM4J	if you are an existing DOM4J user	requires dom4j.jar
XOM	if you are an existing XOM user	requires xom.jar

Updating XML

- [Updating XML with XmlParser](#)
- [Updating XML with XmlSlurper](#)
- [Updating XML with DOMCategory](#)

Validating XML

- [Validating XML with a DTD](#)
- [Validating XML with a W3C XML Schema](#)
- [Validating XML with RELAX NG](#)

Troubleshooting

Some of the following Jira issues may indicate solutions or workarounds to problems other users faced while using XML.

Issue	Description
GROOVY-2126	ClassCastException when using java.util.prefs package

More Information

For some more discussion of the pro's and con's of your XML Processing options and some additional details, see the following books:

- Chapter 12 of [GINA](#)
- [Processing XML with Java](#)
- [Pro XML Development with Java Technology](#)
- [Java and XML](#)

The following articles may also be of interest:

- [Getting Groovy with XML](#) by Jack Herrington.
- [XML and Java technologies: Document models, Part 1: Performance](#)
- [DOM, DOM4J, JDOM, XOM Comparison](#) (slightly outdated)
- [Dom4J performance versus Xerces / Xalan](#)
- [Hints for parsing XHTML with DOM4J](#)

You may also be interested in how XML is applied in other parts of Groovy:

- [Groovy SOAP](#)
- [Testing Web Services](#)
- [Testing Web Applications](#)

Creating XML using Groovy's MarkupBuilder

This page last changed on Feb 29, 2008 by james.lorenzen@accenture.com.

Simple Example

Here is an example of using Groovy's MarkupBuilder to create a new XML file:

```
// require(groupId:'xmlunit', artifactId:'xmlunit', version:'1.0')
import groovy.xml.MarkupBuilder
import org.custommonkey.xmlunit.*

def writer = new StringWriter()
def xml = new MarkupBuilder(writer)
xml.records() {
  car(name:'HSV Maloo', make:'Holden', year:2006) {
    country('Australia')
    record(type:'speed', 'Production Pickup Truck with speed of 271kph')
  }
  car(name:'P50', make:'Peel', year:1962) {
    country('Isle of Man')
    record(type:'size', 'Smallest Street-Legal Car at 99cm wide and 59 kg in weight')
  }
  car(name:'Royale', make:'Bugatti', year:1931) {
    country('France')
    record(type:'price', 'Most Valuable Car at $15 million')
  }
}

XMLUnit.setIgnoreWhitespace(true)
def xmlDiff = new Diff(writer.toString(), XmlExamples.CAR_RECORDS)
assert xmlDiff.similar()
```

We have used [XMLUnit](#) to compare the XML we created with our sample XML. To do this, make sure the sample XML is available, i.e. that the following class is added to your CLASSPATH:

XmlExamples.groovy

```
class XmlExamples {
  static def CAR_RECORDS = '''
<records>
<car name='HSV Maloo' make='Holden' year='2006'>
<country>Australia</country>
<record type='speed'>Production Pickup Truck with speed of 271kph</record>
</car>
<car name='P50' make='Peel' year='1962'>
<country>Isle of Man</country>
<record type='size'>Smallest Street-Legal Car at 99cm wide and 59 kg in weight</record>
</car>
<car name='Royale' make='Bugatti' year='1931'>
<country>France</country>
<record type='price'>Most Valuable Car at $15 million</record>
</car>
</records>
'''
}
```

You may also want to see [Using MarkupBuilder for Agile XML creation](#).

DomToGroovy Example

Also, suppose we have an existing XML document and we want to automate generation of the markup without having to type it all in? We just need to use DomToGroovy as shown in the following example:

```
import javax.xml.parsers.DocumentBuilderFactory
import org.codehaus.groovy.tools.xml.DomToGroovy
```

```

def builder      = DocumentBuilderFactory.newInstance().newDocumentBuilder()
def inputStream = new ByteArrayInputStream(XmlExamples.CAR_RECORDS.bytes)
def document     = builder.parse(inputStream)
def output      = new StringWriter()
def converter    = new DomToGroovy(new PrintWriter(output))

converter.print(document)
println output.toString()

```

Running this will produce the builder code for us.

Namespace Aware Example

Finally, here are some simple examples showing how to include namespaces and prefixes.

Prefix with Namespace

```

def xml = new MarkupBuilder(writer)
xml.'rec:records'('xmlns:rec': 'http://groovy.codehaus.org') {
  car(name:'HSV Maloo', make:'Holden', year:2006) {
    country('Australia')
    record(type:'speed', ' Truck with speed of 271kph')
  }
}

```

result

```

<rec:records xmlns:rec='http://groovy.codehaus.org'>
<car name='HSV Maloo' make='Holden' year='2006'>
<country>Australia</country>
<record type='speed'> Truck with speed of 271kph</record>
</car>
</rec:records>

```

Default Namespace

```

xml.records(xmlns: 'http://groovy.codehaus.org') {
  car(name:'HSV Maloo', make:'Holden', year:2006) {
    country('Australia')
    record(type:'speed', ' Truck with speed of 271kph')
  }
}

```

result

```

<records xmlns='http://groovy.codehaus.org'>
<car name='HSV Maloo' make='Holden' year='2006'>
<country>Australia</country>
<record type='speed'> Truck with speed of 271kph</record>
</car>
</records>

```

Creating XML using Groovy's StreamingMarkupBuilder

This page last changed on Jun 01, 2007 by [paulk_asert](#).

Here is an example of using StreamingMarkupBuilder to create a new XML file:

```
// require(groupId:'xmlunit', artifactId:'xmlunit', version:'1.1beta2')
import groovy.xml.StreamingMarkupBuilder
import org.custommonkey.xmlunit.*

def xml = new StreamingMarkupBuilder().bind{
records {
car(name:'HSV Maloo', make:'Holden', year:2006) {
country('Australia')
record(type:'speed', 'Production Pickup Truck with speed of 271kph')
}
car(name:'P50', make:'Peel', year:1962) {
country('Isle of Man')
record(type:'size', 'Smallest Street-Legal Car at 99cm wide and 59 kg in weight')
}
car(name:'Royale', make:'Bugatti', year:1931) {
country('France')
record(type:'price', 'Most Valuable Car at $15 million')
} } }

XMLUnit.ignoreWhitespace = true
def xmlDiff = new Diff(xml.toString(), XmlExamples.CAR_RECORDS)
assert xmlDiff.similar()
```

We have used [XMLUnit](#) to compare the XML we created with our sample XML. To do this, make sure the sample XML is available, i.e. that the following class is added to your CLASSPATH:

XmlExamples.groovy

```
class XmlExamples {
static def CAR_RECORDS = '''
<records>
<car name='HSV Maloo' make='Holden' year='2006'>
<country>Australia</country>
<record type='speed'>Production Pickup Truck with speed of 271kph</record>
</car>
<car name='P50' make='Peel' year='1962'>
<country>Isle of Man</country>
<record type='size'>Smallest Street-Legal Car at 99cm wide and 59 kg in weight</record>
</car>
<car name='Royale' make='Bugatti' year='1931'>
<country>France</country>
<record type='price'>Most Valuable Car at $15 million</record>
</car>
</records>
'''
}
```

Here's another example illustrating how to produce mixed content:

```
// require(groupId:'xmlunit', artifactId:'xmlunit', version:'1.1beta2')
import groovy.xml.StreamingMarkupBuilder
import org.custommonkey.xmlunit.*

def message = ' <b>wins</b> '
def xml = new StreamingMarkupBuilder().bind{
html() {
body(bgcolor:'red') {
h1('In Breaking News ...')
p {
a(href:'http://groovy.codehaus.org', 'Groovy')
mkp.yieldUnescaped message
}
}
}
}
```

```
a(href='http://jax-award.de/jax_award/gewinner_eng.php', 'Jax')
mkp.yield ' praise & award.'
} } } }
```

```
def expected = '''
<html>
<body bgcolor='red'>
<h1>In Breaking News ...</h1>
<p>
<a href='http://groovy.codehaus.org'>Groovy</a>
<b>wins</b>
<a href='http://jax-award.de/jax_award/gewinner_eng.php'>Jax</a>
praise & award.
</p>
</body>
</html>
'''
```

```
XMLUnit.ignoreWhitespace = true
def xmlDiff = new Diff(xml.toString(), expected)
assert xmlDiff.similar()
```

You may also want to see [Using MarkupBuilder for Agile XML creation.](#)

Creating XML with Groovy and DOM

This page last changed on Oct 07, 2006 by [paulk_asert](#).

Here is an example of using Java's DOM facilities to create a new XML file:

```
// require(groupId:'xmlunit', artifactId:'xmlunit', version:'1.0')
import javax.xml.parsers.DocumentBuilderFactory
import org.custommonkey.xmlunit.*

def addCar(document, root, name, make, year, country, type, text) {
    def car = document.createElement('car')
    car.setAttribute('name', name)
    car.setAttribute('make', make)
    car.setAttribute('year', year)
    root.appendChild(car)
    def countryNode = document.createElement('country')
    countryNode.appendChild(document.createTextNode(country))
    car.appendChild(countryNode)
    def record = document.createElement('record')
    record.setAttribute('type', type)
    record.appendChild(document.createTextNode(text))
    car.appendChild(record)
}

def builder = DocumentBuilderFactory.newInstance().newDocumentBuilder()
def document = builder.newDocument()
def root = document.createElement('records')

document.appendChild(root)
addCar(document, root, 'HSV Maloo', 'Holden', '2006', 'Australia',
'speed', 'Production Pickup Truck with speed of 271kph')
addCar(document, root, 'P50', 'Peel', '1962', 'Isle of Man',
'size', 'Smallest Street-Legal Car at 99cm wide and 59 kg in weight')
addCar(document, root, 'Royale', 'Bugatti', '1931', 'France',
'price', 'Most Valuable Car at $15 million')

// now load in our XML sample and compare it to our newly created document
def builder2 = DocumentBuilderFactory.newInstance().newDocumentBuilder()
def inputStream = new ByteArrayInputStream(XmlExamples.CAR_RECORDS.bytes)
def control = builder2.parse(inputStream)

XMLUnit.setIgnoreWhitespace(true)
def xmlDiff = new Diff(document, control)
assert xmlDiff.similar()
```

We have used [XMLUnit](#) to compare the XML we created with our sample XML. To do this, make sure the sample XML is available, i.e. that the following class is added to your CLASSPATH:

XmlExamples.groovy

```
class XmlExamples {
    static def CAR_RECORDS = '''
<records>
<car name='HSV Maloo' make='Holden' year='2006'>
<country>Australia</country>
<record type='speed'>Production Pickup Truck with speed of 271kph</record>
</car>
<car name='P50' make='Peel' year='1962'>
<country>Isle of Man</country>
<record type='size'>Smallest Street-Legal Car at 99cm wide and 59 kg in weight</record>
</car>
<car name='Royale' make='Bugatti' year='1931'>
<country>France</country>
<record type='price'>Most Valuable Car at $15 million</record>
</car>
</records>'''
}
```

```
'''  
}
```

You may also want to see [Using MarkupBuilder for Agile XML creation](#).

Processing XML with XSLT

This page last changed on May 05, 2007 by [paulk_asert](#).

Groovy's [XML capabilities](#) are powerful enough that you may not need to consider other alternatives such as [XSLT](#). If you wish to use XSLT though, it isn't hard to do. Here we just added xalan and serializer jars from the Apache [Xalan-J](#) project to our CLASSPATH. Depending on your JVM version and other available libraries, you may need slightly different jars (or none at all). Once our path is set up, we can run the following script to convert an XML file into XHTML:

```
// require(url='http://xml.apache.org/xalan-j/', jar='serializer.jar')
// require(url='http://xml.apache.org/xalan-j/', jar='xalan_270.jar')
import javax.xml.transform.TransformerFactory
import javax.xml.transform.stream.StreamResult
import javax.xml.transform.stream.StreamSource

def input = '''
<?xml version="1.0" ?>
<persons>
<person username="JS1">
<name>John</name>
<family_name>Smith</family_name>
</person>
<person username="ND1">
<name>Nancy</name>
<family_name>Davolio</family_name>
</person>
</persons>
'''

def xslt = '''
<xsl:stylesheet xmlns:xsl="http://www.w3.org/1999/XSL/Transform" version="1.0">
<xsl:template match="/persons">
<html xmlns="http://www.w3.org/1999/xhtml">
<head>
<title>Testing XML Example</title>
</head>
<body>
<h1>Persons</h1>
<ul>
<xsl:apply-templates select="person">
<xsl:sort select="family_name" />
</xsl:apply-templates>
</ul>
</body>
</html>
</xsl:template>
<xsl:template match="person">
<li>
<xsl:value-of select="family_name"/>,
<xsl:value-of select="name"/>
</li>
</xsl:template>
</xsl:stylesheet>
'''

def factory = TransformerFactory.newInstance()
def transformer = factory.newTransformer(new StreamSource(new StringReader(xslt)))
transformer.transform(new StreamSource(new StringReader(input)), new StreamResult(System.out))
```

Here is the output (pretty-printed):

```
<?xml version="1.0" encoding="UTF-8"?>
<html xmlns="http://www.w3.org/1999/xhtml">
<head><title>Testing XML Example</title></head>
<body><h1>Persons</h1>
<ul>
```

```
<li>Davolio, Nancy</li>
<li>Smith, John</li>
</ul>
</body>
</html>
```

Depending on your environment (JVM, XSLT processor, operating system) you might be able to make use of XSLT directly from the command line instead of calling it from Java or Groovy. You can also call it from Ant using the `xslt` task.

Reading XML using Groovy's DOMCategory

This page last changed on Oct 21, 2006 by paulk_asert.

Information

Java has in-built support for DOM processing of XML using classes representing the various parts of XML documents, e.g. *Document*, *Element*, *NodeList*, *Attr* etc. For more information about these classes, refer to the respective JavaDocs. Some of the key classes are:

DOM class	JavaDocs
Element	1.4 5
NodeList	1.4 5

Groovy syntax benefits can be applied when using these classes resulting in code which is similar to but more compact than the Java equivalent. In addition, Groovy supports the following built-in helper method for these classes.

DOM class	Method	Description/Equivalent longhand
<i>NodeList</i>	<i>.iterator()</i>	same as for loop, enables closures, e.g. <i>findAll</i> , <i>every</i> , etc.

In addition, the *DOMCategory* class provides numerous additional helper methods and syntax shortcuts:

DOM class	Method	Description/Equivalent longhand
<i>Element</i>	<i>.child</i> or <i>.child</i> or [<i>'child'</i>]	similar to <i>.getElementsByTagName('child')</i> but only gets direct children
<i>Element</i>	<i>.children()</i> or <i>.*'</i> or [<i>'*'</i>]	special case of above which finds all children regardless of tagname (plus text nodes)
<i>Element</i>	<i>.@attr</i> or [<i>'@attr'</i>]	<i>.getAttribute('attr')</i>
<i>Element</i>	<i>.attributes()</i>	equivalent to <i>.attributes</i> returns a <i>NamedNodeMap</i>
<i>Element</i>	<i>.text()</i>	<i>.firstChild.nodeValue</i> (or <i>textContent</i> if you are using Xerces)
<i>Element</i>	<i>.name()</i>	<i>.nodeName</i>
<i>Element</i>	<i>.parent()</i> or <i>..''</i> or [<i>'..''</i>]	<i>.parentNode</i>
<i>Element</i>	<i>.depthFirst()</i> or <i>.'**'</i>	depth-first traversal of nested children
<i>Element</i>	<i>.breadthFirst()</i>	breadth-first traversal of nested children
<i>Node</i>	<i>.toString()</i>	text node value as a <i>String</i>

<i>NodeList</i>	<i>.size()</i>	<i>.length</i>
<i>NodeList</i>	<i>.list()</i>	converted to a list of nodes
<i>NodeList</i>	<i>[n]</i>	<i>.item(n)</i>
<i>NodeList</i>	<i>.text()</i>	<i>.collect{ it.text() }</i>
<i>NodeList</i>	<i>.child</i>	flattened version of <i>.child</i> for each node in the <i>NodeList</i>
<i>NamedNodeMap</i>	<i>.size()</i>	<i>.length</i>
<i>NamedNodeMap</i>	<i>'child'</i> or <i>.child</i> or <i>['child']</i>	<i>.getNamedItem(elementName).nodeValue</i>

All these methods return standard Java classes (e.g. *String* and *List*) or standard DOM classes (e.g. *Element*, *NodeList*), so there are no new classes to learn, just some improved syntax.

Example

This example assumes the following class is already on your CLASSPATH:

XmlExamples.groovy

```
class XmlExamples {
    static def CAR_RECORDS = '''
    <records>
    <car name='HSV Maloo' make='Holden' year='2006'>
    <country>Australia</country>
    <record type='speed'>Production Pickup Truck with speed of 271kph</record>
    </car>
    <car name='P50' make='Peel' year='1962'>
    <country>Isle of Man</country>
    <record type='size'>Smallest Street-Legal Car at 99cm wide and 59 kg in weight</record>
    </car>
    <car name='Royale' make='Bugatti' year='1931'>
    <country>France</country>
    <record type='price'>Most Valuable Car at $15 million</record>
    </car>
    </records>
    '''
}
```

Here is an example of using Groovy's DOMCategory:

```
import groovy.xml.DOMBuilder
import groovy.xml.dom.DOMCategory

messages = []

def processCar(car) {
    assert car.name() == 'car'
    def make = car.'@make'
    def country = car.country[0].text()
    def type = car.record[0]. '@type'
    messages << make + ' of ' + country + ' has a ' + type + ' record'
}

def reader = new StringReader(XmlExamples.CAR_RECORDS)
def doc = DOMBuilder.parse(reader)
def records = doc.documentElement

use (DOMCategory) {
    assert 9 == records.'*'.size()
}
```

```
def cars = records.'car'
assert cars[0].parent() == records
assert 3 == cars.size()
assert 2 == cars.findAll{ it.'@year'.toInteger() > 1950 }.size()
def carsByCentury = cars.list().groupBy{
it.'@year'.toInteger() >= 2000 ? 'this century' : 'last century'
}
assert 1 == carsByCentury['this century'].size()
assert 2 == carsByCentury['last century'].size()
cars.each{ car -> processCar(car) }
}

assert messages == [
'Holden of Australia has a speed record',
'Peel of Isle of Man has a size record',
'Bugatti of France has a price record'
]
```

Reading XML using Groovy's XmlParser

This page last changed on Aug 15, 2007 by [glaforge](#).

This example assumes the following class is already on your CLASSPATH:

XmlExamples.groovy

```
class XmlExamples {
    static def CAR_RECORDS = '''
    <records>
    <car name='HSV Maloo' make='Holden' year='2006'>
    <country>Australia</country>
    <record type='speed'>Production Pickup Truck with speed of 271kph</record>
    </car>
    <car name='P50' make='Peel' year='1962'>
    <country>Isle of Man</country>
    <record type='size'>Smallest Street-Legal Car at 99cm wide and 59 kg in weight</record>
    </car>
    <car name='Royale' make='Bugatti' year='1931'>
    <country>France</country>
    <record type='price'>Most Valuable Car at $15 million</record>
    </car>
    </records>
    '''
}
```

Here is an example of using XmlParser:

```
def records = new XmlParser().parseText(XmlExamples.CAR_RECORDS)
def allRecords = records.car.size()
assert allRecords == 3
def allNodes = records.depthFirst().size()
assert allNodes == 10
def firstRecord = records.car[0]
assert 'car' == firstRecord.name()
assert 'Holden' == firstRecord.@make
assert 'Australia' == firstRecord.country.text()
// 2 cars have an 'e' in the make
assert 2 == records.car.findAll{ it.@make.contains('e') }.size()
// makes of cars that have an 's' followed by an 'a' in the country
assert ['Holden', 'Peel'] == records.car.findAll{ it.country.text() =~ '.*s.*a.*' }.@make
// types of records
assert ['speed', 'size', 'price'] == records.depthFirst().grep{ it.@type }.@type
// update to show what would happen if 'New Zealand' bought Holden
firstRecord.country[0].value = ['New Zealand']
assert 'New Zealand' == firstRecord.country.text()
// names of cars with records sorted by year
assert ['Royale', 'P50', 'HSV Maloo'] == records.car.sort{ it.@year.toInteger() }.@name
```

It is also possible to parse XML documents using namespaces:

```
def ns = new groovy.xml.Namespace("http://www.example.com/book", 'ns')
def root = new XmlParser().parserText("...")
def authors = root[ns.book][ns.author]
```

Reading XML using Groovy's XmlSlurper

This page last changed on Feb 04, 2008 by [rthornton](#).

This example assumes the following class is already on your CLASSPATH:

XmlExamples.groovy

```
class XmlExamples {
    static def CAR_RECORDS = '''
<records>
<car name='HSV Maloo' make='Holden' year='2006'>
<country>Australia</country>
<record type='speed'>Production Pickup Truck with speed of 271kph</record>
</car>
<car name='P50' make='Peel' year='1962'>
<country>Isle of Man</country>
<record type='size'>Smallest Street-Legal Car at 99cm wide and 59 kg in weight</record>
</car>
<car name='Royale' make='Bugatti' year='1931'>
<country>France</country>
<record type='price'>Most Valuable Car at $15 million</record>
</car>
</records>
'''
}
```

Here is an example of using XmlSlurper:

```
def records = new XmlSlurper().parseText(XmlExamples.CAR_RECORDS)
def allRecords = records.car
assert 3 == allRecords.size()
def allNodes = records.depthFirst().collect{ it }
assert 10 == allNodes.size()
def firstRecord = records.car[0]
assert 'car' == firstRecord.name()
assert 'Holden' == firstRecord.@make.text()
assert 'Australia' == firstRecord.country.text()
def carsWith_e_InMake = records.car.findAll{ it.@make.text().contains('e') }
assert carsWith_e_InMake.size() == 2
// alternative way to find cars with 'e' in make
assert 2 == records.car.findAll{ it.@make =~ '.*e.*' }.size()
// makes of cars that have an 's' followed by an 'a' in the country
assert ['Holden', 'Peel'] == records.car.findAll{ it.country =~
'.*s.*a.*' }.@make.collect{ it.text() }
def expectedRecordTypes = ['speed', 'size', 'price']
assert expectedRecordTypes == records.depthFirst().grep{ it.@type != '' }.@type*.text()
assert expectedRecordTypes == records.'**'.grep{ it.@type != '' }.@type*.text()
def countryOne = records.car[1].country
assert 'Peel' == countryOne.parent().@make.text()
assert 'Peel' == countryOne.'..'.@make.text()
// names of cars with records sorted by year
def sortedNames = records.car.list().sort{ it.@year.toInteger() }.@name*.text()
assert ['Royale', 'P50', 'HSV Maloo'] == sortedNames
assert ['Australia', 'Isle of Man'] == records.'**'.grep{ it.@type =~
's.*' }.parent().country*.text()
assert 'co-re-co-re-co-re' == records.car.children().collect{ it.name()[0..1] }.join('-')
assert 'co-re-co-re-co-re' == records.car.'*'.collect{ it.name()[0..1] }.join('-')
```

Notes:

- If your elements contain characters such as dashes, you can enclose the element name in double quotes. Meaning for:

```
<foo>
<foo-bar>test</foo-bar>
</foo>
```

- You do the following:

```
def foo = new XmlSlurper.parseText(FOO_XML)
assert "test" == foo."foo-bar".text()
```

You can also parse XML documents using namespaces:

```
def wsdl = '''
<definitions name="AgencyManagementService"
xmlns:ns1="http://www.example.org/NS1"
xmlns:ns2="http://www.example.org/NS2">
<ns1:message name="SomeRequest">
<ns1:part name="parameters" element="SomeReq" />
</ns1:message>
<ns2:message name="SomeRequest">
<ns2:part name="parameters" element="SomeReq" />
</ns2:message>
</definitions>
'''
```

```
def xml = new XmlSlurper().parseText(wsdl).declareNamespace(ns1: 'http://www.example.org/NS1', ns2:
'http://www.example.org/NS2')
println xml.'ns1:message'. 'ns1:part'.size()
println xml.'ns2:message'. 'ns2:part'.size()
```

XmlSlurper has a declareNamespace method which takes a Map of prefix to URI mappings. You declare the namespaces and just use the prefixes in the GPath expression.

```
new XmlSlurper().parseText(blog).declareNamespace(dc: "http://purl.org/dc/
elements/1.1/") .channel.item.findAll { item ->
d.any{entry -> item."dc:date".text() =~ entry.key} && a.any{entry -> item.tags.text() =~ entry
}
```

Some remarks:

- name or "*" :name" matches an element named "name" irrespective of the namespace it's in (i.e. this is the default mode of operation)
- ":"name" matches an element named "name" only if the element is not in a namespace
- "prefix:name" matches an element named "name" only if it is in the namespace identified by the prefix "prefix" (and the prefix to namespace mapping was defined by a previous call to declareNamespace)

You can generate namespaced elements in StreamingMarkupBuilder very easily:

```
System.out << new StreamingMarkupBuilder().bind {
mkp.declareNamespace(dc: "http://purl.org/dc/elements/1.1/")

root {
dc.date()
}
}
```

Reading XML with Groovy and DOM

This page last changed on Oct 03, 2006 by [paulk_asert](#).

This example assumes the following class is already on your CLASSPATH:

XmlExamples.groovy

```
class XmlExamples {
    static def CAR_RECORDS = '''
    <records>
    <car name='HSV Maloo' make='Holden' year='2006'>
    <country>Australia</country>
    <record type='speed'>Production Pickup Truck with speed of 271kph</record>
    </car>
    <car name='P50' make='Peel' year='1962'>
    <country>Isle of Man</country>
    <record type='size'>Smallest Street-Legal Car at 99cm wide and 59 kg in weight</record>
    </car>
    <car name='Royale' make='Bugatti' year='1931'>
    <country>France</country>
    <record type='price'>Most Valuable Car at $15 million</record>
    </car>
    </records>
    '''
}
```

Here is an example of using DOM with Groovy to read an existing XML file:

```
import javax.xml.parsers.DocumentBuilderFactory

messages = []

def processCar(car) {
    if (car.nodeName != 'car') return
    def make = car.attributes.getNamedItem('make').nodeValue
    def country = car.getElementsByTagName('country').item(0).firstChild.nodeValue
    def type = car.childNodes.find{'record' == it.nodeName}.attributes.getNamedItem('type').nodeValue
    messages << make + ' of ' + country + ' has a ' + type + ' record'
}

def builder = DocumentBuilderFactory.newInstance().newDocumentBuilder()
def inputStream = new ByteArrayInputStream(XmlExamples.CAR_RECORDS.bytes)
def records = builder.parse(inputStream).documentElement

def cars = records.childNodes
(0..<cars.length).each{ processCar(cars.item(it)) }

assert messages == [
    'Holden of Australia has a speed record',
    'Peel of Isle of Man has a size record',
    'Bugatti of France has a price record'
]
```

Reading XML with Groovy and SAX

This page last changed on Oct 03, 2006 by [paulk_asert](#).

This example assumes the following class is already on your CLASSPATH:

XmlExamples.groovy

```
class XmlExamples {
    static def CAR_RECORDS = '''
    <records>
    <car name='HSV Maloo' make='Holden' year='2006'>
    <country>Australia</country>
    <record type='speed'>Production Pickup Truck with speed of 271kph</record>
    </car>
    <car name='P50' make='Peel' year='1962'>
    <country>Isle of Man</country>
    <record type='size'>Smallest Street-Legal Car at 99cm wide and 59 kg in weight</record>
    </car>
    <car name='Royale' make='Bugatti' year='1931'>
    <country>France</country>
    <record type='price'>Most Valuable Car at $15 million</record>
    </car>
    </records>
    '''
}
```

Here is an example of using SAX with Groovy:

```
import javax.xml.parsers.SAXParserFactory
import org.xml.sax.helpers.DefaultHandler
import org.xml.sax.*

class RecordsHandler extends DefaultHandler {
    def messages = []
    def currentMessage
    def countryFlag = false
    void startElement(String ns, String localName, String qName, Attributes atts) {
        switch (qName) {
            case 'car':
                currentMessage = atts.getValue('make') + ' of '; break
            case 'country':
                countryFlag = true; break
            case 'record':
                currentMessage += atts.getValue('type') + ' record'; break
        }
    }
    void characters(char[] chars, int offset, int length) {
        if (countryFlag) {
            currentMessage += new String(chars, offset, length)
        }
    }
    void endElement(String ns, String localName, String qName) {
        switch (qName) {
            case 'car':
                messages << currentMessage; break
            case 'country':
                currentMessage += ' has a '; countryFlag = false; break
        }
    }
}

def handler = new RecordsHandler()
def reader = SAXParserFactory.newInstance().newSAXParser().XMLReader
reader.setContentHandler(handler)
def inputStream = new ByteArrayInputStream(XmlExamples.CAR_RECORDS.bytes)
reader.parse(new InputSource(inputStream))
```

```
assert handler.messages == [  
  'Holden of Australia has a speed record',  
  'Peel of Isle of Man has a size record',  
  'Bugatti of France has a price record'  
]
```

Reading XML with Groovy and StAX

This page last changed on Oct 07, 2006 by [paulk_asert](#).

This example assumes the following class is already on your CLASSPATH:

XmlExamples.groovy

```
class XmlExamples {
    static def CAR_RECORDS = '''
    <records>
    <car name='HSV Maloo' make='Holden' year='2006'>
    <country>Australia</country>
    <record type='speed'>Production Pickup Truck with speed of 271kph</record>
    </car>
    <car name='P50' make='Peel' year='1962'>
    <country>Isle of Man</country>
    <record type='size'>Smallest Street-Legal Car at 99cm wide and 59 kg in weight</record>
    </car>
    <car name='Royale' make='Bugatti' year='1931'>
    <country>France</country>
    <record type='price'>Most Valuable Car at $15 million</record>
    </car>
    </records>
    '''
}
```

Here is an example of reading an existing XML file with Groovy and [StAX](#):

```
// require(groupId:'stax', artifactId:'stax-api', version:'1.0.1')
// require(groupId:'stax', artifactId:'stax', version:'1.2.0')
import javax.xml.stream.*

messages = []
currentMessage = ''

def processStream(inputStream) {
    def reader
    try {
        reader = XMLInputFactory.newInstance()
            .createXMLStreamReader(inputStream)
        while (reader.hasNext()) {
            if (reader.startElement)
                processStartElement(reader)
            reader.next()
        }
    } finally {
        reader?.close()
    }
}

def processStartElement(element) {
    switch(element.name()) {
        case 'car':
            currentMessage = element.make + " of "
            break
        case 'country':
            currentMessage += element.text() + " has a "
            break
        case 'record':
            currentMessage += element.type + " record"
            messages << currentMessage
            break
    }
}

class StaxCategory {
```

```
static Object get(XMLStreamReader self, String key) {
return self.getAttributeValue(null, key)
}
static String name(XMLStreamReader self) {
return self.name.toString()
}
static String text(XMLStreamReader self) {
return self.elementText
}
}

def bytes = XmlExamples.CAR_RECORDS.bytes
def inputStream = new ByteArrayInputStream(bytes)
use (StaxCategory) { processStream(inputStream) }

assert messages == [
'Holden of Australia has a speed record',
'Peel of Isle of Man has a size record',
'Bugatti of France has a price record'
]
```

Reading XML with Groovy and XPath

This page last changed on Apr 02, 2008 by [paulk_asert](#).

Car Example

This example assumes the following class is already on your CLASSPATH:

XmlExamples.groovy

```
class XmlExamples {
    static def CAR_RECORDS = '''
    <records>
    <car name='HSV Maloo' make='Holden' year='2006'>
    <country>Australia</country>
    <record type='speed'>Production Pickup Truck with speed of 271kph</record>
    </car>
    <car name='P50' make='Peel' year='1962'>
    <country>Isle of Man</country>
    <record type='size'>Smallest Street-Legal Car at 99cm wide and 59 kg in weight</record>
    </car>
    <car name='Royale' make='Bugatti' year='1931'>
    <country>France</country>
    <record type='price'>Most Valuable Car at $15 million</record>
    </car>
    </records>
    '''
}
```

Using Xalan

Here is an example of using Apache [Xalan](#) with Groovy to read an existing XML file:

```
// require(groupId:'xalan', artifactId:'xalan', version:'2.6.0')
import org.apache.xpath.XPathAPI
import javax.xml.parsers.DocumentBuilderFactory

messages = []

def processCar(car) {
    def make = XPathAPI.eval(car, '@make').str()
    def country = XPathAPI.eval(car, 'country/text()').str()
    def type = XPathAPI.eval(car, 'record/@type').str()
    messages << make + ' of ' + country + ' has a ' + type + ' record'
}

def builder = DocumentBuilderFactory.newInstance().newDocumentBuilder()
def inputStream = new ByteArrayInputStream(XmlExamples.CAR_RECORDS.bytes)
def records = builder.parse(inputStream).documentElement

XPathAPI.selectNodeList(records, '//car').each{ processCar(it) }

assert messages == [
    'Holden of Australia has a speed record',
    'Peel of Isle of Man has a size record',
    'Bugatti of France has a price record'
]
```

Using Jaxen

Here is an example of using [Jaxen](#) with Groovy to read an existing XML file:

```
// require(groupId:'jaxen', artifactId:'jaxen', version:'1.1-beta-10')
import org.jaxen.dom.DOMXPath
import javax.xml.parsers.DocumentBuilderFactory
```

```

messages = []

def processCar(car) {
def make = new DOMXPath('@make').stringValueOf(car)
def country = new DOMXPath('country/text()').stringValueOf(car)
def type = new DOMXPath('record/@type').stringValueOf(car)
messages << make + ' of ' + country + ' has a ' + type + ' record'
}

def builder      = DocumentBuilderFactory.newInstance().newDocumentBuilder()
def inputStream = new ByteArrayInputStream(XmlExamples.CAR_RECORDS.bytes)
def records      = builder.parse(inputStream).documentElement

new DOMXPath('//car').selectNodes(records).each{ processCar(it) }

assert messages == [
'Holden of Australia has a speed record',
'Peel of Isle of Man has a size record',
'Bugatti of France has a price record'
]

```

Note: many libraries (e.g. DOM4J, JDOM, XOM) bundle or provide optional support for Jaxen. You may not need to download any additional JARs to use it.

Using Java's native XPath support

If you are using Java 5 and above, you don't need to use the standalone Xalan jar but instead can use the now built-in XPath facilities:

```

import javax.xml.xpath.*

def xpath = XPathFactory.newInstance().newXPath()

def nodes = xpath.evaluate( '//car', records, XPathConstants.NODESET )
nodes.each{
def make = xpath.evaluate( '@make', it )
def country = xpath.evaluate( 'country/text()', it )
def type = xpath.evaluate( 'record/@type', it )
messages << "$make of $country has a $type record"
}

```

People in Groups Example

Inspired by [this example](#), here is how to use XPath to determine which groups include all three of *alan*, *paul* and *ivan* for this graph representing group membership.

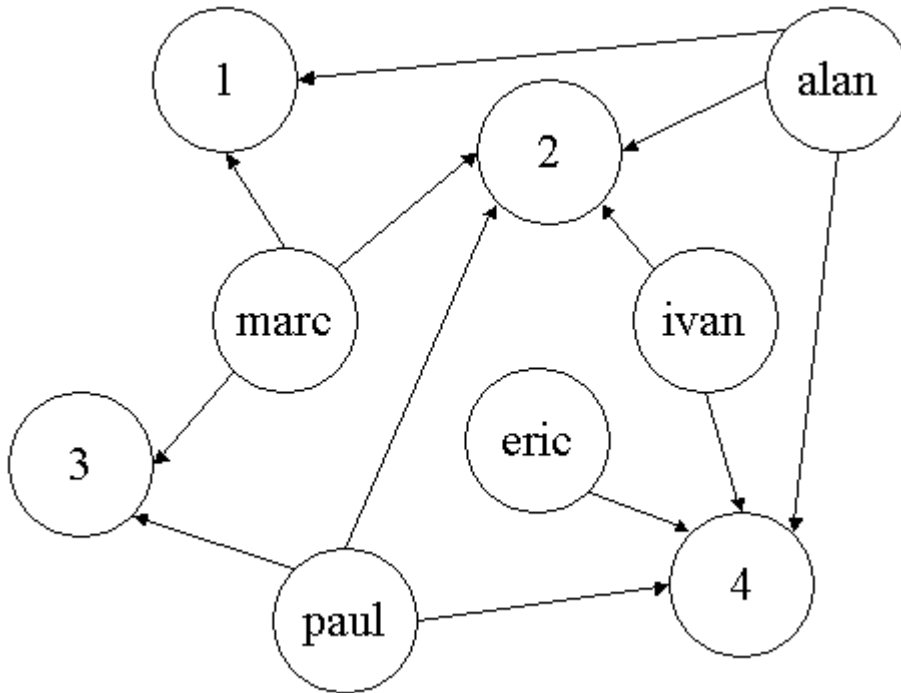

Picture source: <http://stage.vambenepe.com/pages/graph.png>

First, here is the XML data capturing the group membership information:

```
def xml = '''
<doc>
<person name="alan"><g>1</g><g>2</g><g>4</g></person>
<person name="marc"><g>1</g><g>2</g><g>3</g></person>
<person name="paul"><g>2</g><g>3</g><g>4</g></person>
<person name="ivan"><g>2</g><g>4</g></person>
<person name="eric"><g>4</g></person>
</doc>
'''
```

Using Java's native XPath support

Here is how to check that groups 2 and 4 are the groups in question using the built-in XPath capabilities of Java 5 and above:

```
import javax.xml.parsers.DocumentBuilderFactory
import javax.xml.xpath.*

xpath = '''
/doc/person[@name="alan"]/g
[./doc/person[@name="paul"]/g]
[./doc/person[@name="ivan"]/g]
'''

builder = DocumentBuilderFactory.newInstance().newDocumentBuilder()
doc = builder.parse(new ByteArrayInputStream(xml.bytes))
expr = XPathFactory.newInstance().newXPath().compile(xpath)
nodes = expr.evaluate(doc, XPathConstants.NODESET)
assert nodes.collect { node -> node.textContent } == ['2', '4']
```

And you can refactor your XPath Expression with something like:

```
import javax.xml.parsers.DocumentBuilderFactory
import javax.xml.xpath.*
```



```

groupsOf = { name -> "/doc/person[@name='$name']/g" }
xpath    = "${groupsOf 'alan'}[.=${groupsOf 'paul'}][.=${groupsOf 'ivan'}]"
builder  = DocumentBuilderFactory.newInstance().newDocumentBuilder()
doc      = builder.parse(new ByteArrayInputStream(xml.bytes))
expr     = XPathFactory.newInstance().newXPath().compile(xpath)
nodes    = expr.evaluate(doc, XPathConstants.NODESET)
assert   nodes.collect { node -> node.textContent } == ['2', '4']

```

Using GPath

Of course, you can also do this without XPath by using Groovy's GPath facilities as follows:

```

def root = new XmlParser().parseText(xml)
Set groups = root.person.g.collect { it.text() }
assert groups.findAll { group ->
root.person.g.findAll {
it.text() == group
}..'..'@name'.containsAll(['alan', 'paul', 'ivan'])
} == ['2', '4']

```

Updating XML with DOMCategory

This page last changed on Oct 28, 2007 by [paulk_asert](#).

Here is an example of updating XML using DOMCategory:

```
// require(groupId:'xmlunit', artifactId:'xmlunit', version:'1.1')
import groovy.xml.dom.DOMUtil
import groovy.xml.dom.DOMCategory
import groovy.xml.DOMBuilder
import org.custommonkey.xmlunit.Diff
import org.custommonkey.xmlunit.XMLUnit

def input = '''
<shopping>
<category type="groceries">
<item>Chocolate</item>
<item>Coffee</item>
</category>
<category type="supplies">
<item>Paper</item>
<item quantity="4">Pens</item>
</category>
<category type="present">
<item when="Aug 10">Kathryn's Birthday</item>
</category>
</shopping>
'''

def expectedResult = '''
<shopping>
<category type="groceries">
<item>Luxury Chocolate</item>
<item>Luxury Coffee</item>
</category>
<category type="supplies">
<item>Paper</item>
<item quantity="6" when="Urgent">Pens</item>
</category>
<category type="present">
<item>Mum's Birthday</item>
<item when="Oct 15">Monica's Birthday</item>
</category>
</shopping>
'''

def reader = new StringReader(input)
def doc = DOMBuilder.parse(reader)
def root = doc.documentElement

use(DOMCategory) {
// modify groceries: quality items please
def groceries = root.category.findAll{ it.'@type' == 'groceries' }[0].item
groceries.each { g ->
g.value = 'Luxury ' + g.text()
}

// modify supplies: we need extra pens
def supplies = root.category.findAll{ it.'@type' == 'supplies' }[0].item
supplies.findAll{ it.text() == 'Pens' }.each { s ->
s['@quantity'] = s.'@quantity'.toInteger() + 2
s['@when'] = 'Urgent'
}

// modify presents: August has come and gone
def presents = root.category.find{ it.'@type' == 'present' }
presents.item.each {
```

```
presents.removeChild(it)
}
presents.appendChild('item', "Mum's Birthday")
presents.appendChild('item', [when:'Oct 15'], "Monica's Birthday")

// check the when attributes
assert root.'**'.item.'@when'.grep{it} == ["Urgent", "Oct 15"]
}

// check the whole document using XmlUnit
XMLUnit.setIgnoreWhitespace(true)
def result = DOMUtil.serialize(root)
def xmlDiff = new Diff(result, expectedResult)
assert xmlDiff.identical()
```

Updating XML with XmlParser

This page last changed on Oct 27, 2007 by [paulk_asert](#).

Here is an example of updating XML using XmlParser:

```
// require(groupId:'xmlunit', artifactId:'xmlunit', version:'1.1')
import org.custommonkey.xmlunit.Diff
import org.custommonkey.xmlunit.XMLUnit

def input = '''
<shopping>
<category type="groceries">
<item>Chocolate</item>
<item>Coffee</item>
</category>
<category type="supplies">
<item>Paper</item>
<item quantity="4">Pens</item>
</category>
<category type="present">
<item when="Aug 10">Kathryn's Birthday</item>
</category>
</shopping>
'''

def expectedResult = '''
<shopping>
<category type="groceries">
<item>Luxury Chocolate</item>
<item>Luxury Coffee</item>
</category>
<category type="supplies">
<item>Paper</item>
<item quantity="6" when="Urgent">Pens</item>
</category>
<category type="present">
<item>Mum's Birthday</item>
<item when="Oct 15">Monica's Birthday</item>
</category>
</shopping>
'''

def root = new XmlParser().parseText(input)

// modify groceries: quality items please
def groceries = root.category.findAll{ it.@type == 'groceries' }.item
groceries.each { g ->
g.value = 'Luxury ' + g.text()
}

// modify supplies: we need extra pens
def supplies = root.category.findAll{ it.@type == 'supplies' }.item
supplies.findAll{ it.text() == 'Pens' }.each { s ->
s.@quantity = s.@quantity.toInteger() + 2
s.@when = 'Urgent'
}

// modify presents: August has come and gone
def presentCategory = root.category.find{ it.@type == 'present' }
presentCategory.children().clear()
presentCategory.appendChild('item', "Mum's Birthday")
presentCategory.appendChild('item', [when:'Oct 15'], "Monica's Birthday")

// check the when attributes
def removeNulls(list) { list.grep{it} }
assert removeNulls(root.'**'.item.@when) == ["Urgent", "Oct 15"]
```

```
// check the whole document using XmlUnit
def writer = new StringWriter()
new XmlNodePrinter(new PrintWriter(writer)).print(root)
def result = writer.toString()

XMLUnit.setIgnoreWhitespace(true)
def xmlDiff = new Diff(result, expectedResult)
assert xmlDiff.identical()
```

Updating XML with XmlSlurper

This page last changed on Oct 28, 2007 by [paulk_asert](#).

Here is an example of updating XML using XmlSlurper:

```
// require(groupId:'xmlunit', artifactId:'xmlunit', version:'1.1')
import org.custommonkey.xmlunit.Diff
import org.custommonkey.xmlunit.XMLUnit
import groovy.xml.StreamingMarkupBuilder

def input = '''
<shopping>
<category type="groceries">
<item>Chocolate</item>
<item>Coffee</item>
</category>
<category type="supplies">
<item>Paper</item>
<item quantity="4">Pens</item>
</category>
<category type="present">
<item when="Aug 10">Kathryn's Birthday</item>
</category>
</shopping>
'''

def expectedResult = '''
<shopping>
<category type="groceries">
<item>Luxury Chocolate</item>
<item>Luxury Coffee</item>
</category>
<category type="supplies">
<item>Paper</item>
<item quantity="6" when="Urgent">Pens</item>
</category>
<category type="present">
<item>Mum's Birthday</item>
<item when="Oct 15">Monica's Birthday</item>
</category>
</shopping>
'''

def root = new XmlSlurper().parseText(input)

// modify groceries: quality items please
def groceries = root.category.find{ it.@type == 'groceries' }
(0..<groceries.item.size()).each {
groceries.item[it] = 'Luxury ' + groceries.item[it]
}

// modify supplies: we need extra pens
def pens = root.category.find{ it.@type == 'supplies' }.item.findAll{ it.text() == 'Pens' }
pens.each { p ->
p.@quantity = (p.@quantity.toInteger() + 2).toString()
p.@when = 'Urgent'
}

// modify presents: August has come and gone
def presents = root.category.find{ it.@type == 'present' }
presents.replaceNode{ node ->
category(type:'present'){
item("Mum's Birthday")
item("Monica's Birthday", when:'Oct 15')
}
}
}
```

```
// check the whole document using XmlUnit
def outputBuilder = new StreamingMarkupBuilder()
String result = outputBuilder.bind{ mkp.yield root }

XMLUnit.setIgnoreWhitespace(true)
def xmlDiff = new Diff(result, expectedResult)
assert xmlDiff.similar()

// check the when attributes (can't do before now due to delayed setting)
def resultRoot = new XmlSlurper().parseText(result)
def removeNulls(list) { list.grep{it} }
assert removeNulls(resultRoot.'*'.item.@when) == ["Urgent", "Oct 15"]
```

Using Other XML Libraries

This page last changed on Sep 25, 2007 by [tomstrummer](#).

Groovy integrates with pretty much any third-party XML library in Java:

- [Creating XML with Groovy and DOM4J](#)
- [Creating XML with Groovy and JDOM](#)
- [Creating XML with Groovy and XOM](#)
- [Processing XML with XQuery](#)
- [Reading XML with Groovy and DOM4J](#)
- [Reading XML with Groovy and JDOM](#)
- [Reading XML with Groovy and XOM](#)

Creating XML with Groovy and DOM4J

This page last changed on Sep 25, 2007 by [tomstrummer](#).

Here is an example of using DOM4J to create a new XML file:

```
// require(groupId:'xmlunit', artifactId:'xmlunit', version:'1.0')
// require(groupId:'dom4j', artifactId:'dom4j', version:'1.6.1')
import javax.xml.parsers.DocumentBuilderFactory
import org.custommonkey.xmlunit.*
import org.dom4j.io.XMLWriter
import org.dom4j.*

def addCar(root, name, make, year, country, type, text) {
    def car = root.addElement('car')
    car.addAttribute('name', name)
    car.addAttribute('make', make)
    car.addAttribute('year', year)
    def countryNode = car.addElement('country').addText(country)
    def record = car.addElement('record').addText(text)
    record.addAttribute('type', type)
}

def document = DocumentHelper.createDocument()
def root      = document.addElement('records')

addCar(root, 'HSV Maloo', 'Holden', '2006', 'Australia',
'speed', 'Production Pickup Truck with speed of 271kph')
addCar(root, 'P50', 'Peel', '1962', 'Isle of Man',
'size', 'Smallest Street-Legal Car at 99cm wide and 59 kg in weight')
addCar(root, 'Royale', 'Bugatti', '1931', 'France',
'price', 'Most Valuable Car at $15 million')

// convert resulting document to a string so that we can compare
XMLUnit.setIgnoreWhitespace(true)
def writer = new StringWriter()
new XMLWriter(writer).writeNode(document)
def xmlDiff = new Diff(writer.toString(), XmlExamples.CAR_RECORDS)
assert xmlDiff.similar()
```

We have used [XMLUnit](#) to compare the XML we created with our sample XML. To do this, make sure the sample XML is available, i.e. that the following class is added to your CLASSPATH:

XmlExamples.groovy

```
class XmlExamples {
    static def CAR_RECORDS = '''
<records>
<car name='HSV Maloo' make='Holden' year='2006'>
<country>Australia</country>
<record type='speed'>Production Pickup Truck with speed of 271kph</record>
</car>
<car name='P50' make='Peel' year='1962'>
<country>Isle of Man</country>
<record type='size'>Smallest Street-Legal Car at 99cm wide and 59 kg in weight</record>
</car>
<car name='Royale' make='Bugatti' year='1931'>
<country>France</country>
<record type='price'>Most Valuable Car at $15 million</record>
</car>
</records>
'''
}
```

You may also want to see [Using MarkupBuilder for Agile XML creation](#).

Creating XML with Groovy and JDOM

This page last changed on Sep 25, 2007 by [tomstrummer](#).

Here is an example of using [JDOM](#) to create a new XML file:

```
// require(groupId:'xmlunit', artifactId:'xmlunit', version:'1.0')
// require(groupId:'jdom', artifactId:'jdom', version:'1.0')
import javax.xml.parsers.DocumentBuilderFactory
import org.custommonkey.xmlunit.*
import org.jdom.output.XMLOutputter
import org.jdom.*

def addCar(root, name, make, year, country, type, text) {
    def car = new Element('car')
    car.setAttribute('name', name)
    car.setAttribute('make', make)
    car.setAttribute('year', year)
    root.addContent(car)
    def countryCode = new Element('country').setText(country)
    car.addContent(countryCode)
    def record = new Element('record').setText(text)
    record.setAttribute('type', type)
    car.addContent(record)
}

def root = new Element('records')
def document = new Document(root)
document.setRootElement(root)

addCar(root, 'HSV Maloo', 'Holden', '2006', 'Australia',
'speed', 'Production Pickup Truck with speed of 271kph')
addCar(root, 'P50', 'Peel', '1962', 'Isle of Man',
'size', 'Smallest Street-Legal Car at 99cm wide and 59 kg in weight')
addCar(root, 'Royale', 'Bugatti', '1931', 'France',
'price', 'Most Valuable Car at $15 million')

// convert resulting document to a string so that we can compare
XMLUnit.setIgnoreWhitespace(true)
def writer = new StringWriter()
new XMLOutputter().output(document, writer)
def xmlDiff = new Diff(writer.toString(), XmlExamples.CAR_RECORDS)
assert xmlDiff.similar()
```

We have used [XMLUnit](#) to compare the XML we created with our sample XML. To do this, make sure the sample XML is available, i.e. that the following class is added to your CLASSPATH:

XmlExamples.groovy

```
class XmlExamples {
    static def CAR_RECORDS = '''
<records>
<car name='HSV Maloo' make='Holden' year='2006'>
<country>Australia</country>
<record type='speed'>Production Pickup Truck with speed of 271kph</record>
</car>
<car name='P50' make='Peel' year='1962'>
<country>Isle of Man</country>
<record type='size'>Smallest Street-Legal Car at 99cm wide and 59 kg in weight</record>
</car>
<car name='Royale' make='Bugatti' year='1931'>
<country>France</country>
<record type='price'>Most Valuable Car at $15 million</record>
</car>
</records>
'''
}
```

You may also want to see [Using MarkupBuilder for Agile XML creation.](#)

Creating XML with Groovy and XOM

This page last changed on Sep 25, 2007 by [tomstrummer](#).

Here is an example of using [XOM](#) to create a new XML file:

```
// require(groupId:'xmlunit', artifactId:'xmlunit', version:'1.0')
// require(groupId:'xom', artifactId:'xom', version:'1.1')
import javax.xml.parsers.DocumentBuilderFactory
import org.custommonkey.xmlunit.*
import nu.xom.*

def addCar(root, name, make, year, country, type, text) {
    def car = new Element('car')
    car.addAttribute(new Attribute('name', name))
    car.addAttribute(new Attribute('make', make))
    car.addAttribute(new Attribute('year', year))
    root.appendChild(car)
    def countryNode = new Element('country')
    countryNode.appendChild(country)
    car.appendChild(countryNode)
    def record = new Element('record')
    record.appendChild(text)
    record.addAttribute(new Attribute('type', type))
    car.appendChild(record)
}

def root      = new Element('records')
def document = new Document(root)

addCar(root, 'HSV Maloo', 'Holden', '2006', 'Australia',
'speed', 'Production Pickup Truck with speed of 271kph')
addCar(root, 'P50', 'Peel', '1962', 'Isle of Man',
'size', 'Smallest Street-Legal Car at 99cm wide and 59 kg in weight')
addCar(root, 'Royale', 'Bugatti', '1931', 'France',
'price', 'Most Valuable Car at $15 million')

// convert resulting document to a string and compare with expected
XMLUnit.setIgnoreWhitespace(true)
def xmlDiff = new Diff(document.toXML(), XmlExamples.CAR_RECORDS)
assert xmlDiff.similar()
```

We have used [XMLUnit](#) to compare the XML we created with our sample XML. To do this, make sure the sample XML is available, i.e. that the following class is added to your CLASSPATH:

XmlExamples.groovy

```
class XmlExamples {
    static def CAR_RECORDS = '''
<records>
<car name='HSV Maloo' make='Holden' year='2006'>
<country>Australia</country>
<record type='speed'>Production Pickup Truck with speed of 271kph</record>
</car>
<car name='P50' make='Peel' year='1962'>
<country>Isle of Man</country>
<record type='size'>Smallest Street-Legal Car at 99cm wide and 59 kg in weight</record>
</car>
<car name='Royale' make='Bugatti' year='1931'>
<country>France</country>
<record type='price'>Most Valuable Car at $15 million</record>
</car>
</records>
'''
}
```

You may also want to see [Using MarkupBuilder for Agile XML creation](#).

Processing XML with XQuery

This page last changed on Dec 28, 2007 by [paulk_asert](#).

Groovy's [XML capabilities](#) are powerful enough that you may not need to consider other alternatives such as [XQuery](#). If you wish to use XQuery though, it isn't hard to do. Here we just added mxquery.jar from the [MXQuery](#) project to our CLASSPATH. MXQuery is still under development and may not support all of XQuery yet but it appears to be making good progress and has a relatively small footprint.

Once our path is set up, we can run the following script:

```
// require(url:'http://www.mxquery.org', jar:'mxquery.jar', version:'0.2.1')
import ch.ethz.mxquery.util.IteratorPrinter
import ch.ethz.mxquery.core.XQueryRuntime

def query = '''
(: DESCRIPTION: Deletes and inserts a node in a transform expression. :)

transform
copy $x := <doc><el><node>this node is deleted</node></el></doc>
modify
(
do delete $x/el/node,
do insert <node>this node is inserted</node> into $x/el
)
return $x/el
'''

def runtime = new XQueryRuntime()
def exp = runtime.prepareQuery(query)
def result = exp.evaluate()
println IteratorPrinter.eventsToXML(result)
// => <el><node>this node is inserted</node></el>
```

Or using a later version of the library:

```
// require(url:'http://www.mxquery.org', jar:'mxquery.jar', version:'0.4.1')
import ch.ethz.mxquery.query.Context
import ch.ethz.mxquery.query.impl.CompilerImpl
import static ch.ethz.mxquery.util.IteratorPrinter.*

def query1 = 'for $seq in (1,2,3,4,5) where $seq mod 2 eq 0 return $seq'
def context = new Context()
def compiler = new CompilerImpl()
def result = compiler.compile(context, query1).evaluate()
println eventsToString(result)
// =>
// 0: [12815 xs:integer 2]
// 1: [12815 xs:integer 4]
// 2: [64 END_SEQUENCE]

def query2 = '''
copy $x := <doc><el><node>this node is deleted</node></el></doc>
modify
(
delete node $x/el/node,
insert node <node>this node is inserted</node> into $x/el
)
return $x/el
'''

result = compiler.compile(context, query2).evaluate()
println XMLPrettyPrint(eventsToXML(result).toString())
// =>
// <el>
//   <node>
//     this node is inserted
//   </node>
// </el>
```

Depending on your XQuery processor and operating system, you might be able to make use of XQuery directly from the command line instead of calling it from Java or Groovy.

Reading XML with Groovy and DOM4J

This page last changed on Sep 25, 2007 by [tomstrummer](#).

This example assumes the following class is already on your CLASSPATH:

XmlExamples.groovy

```
class XmlExamples {
    static def CAR_RECORDS = '''
<records>
<car name='HSV Maloo' make='Holden' year='2006'>
<country>Australia</country>
<record type='speed'>Production Pickup Truck with speed of 271kph</record>
</car>
<car name='P50' make='Peel' year='1962'>
<country>Isle of Man</country>
<record type='size'>Smallest Street-Legal Car at 99cm wide and 59 kg in weight</record>
</car>
<car name='Royale' make='Bugatti' year='1931'>
<country>France</country>
<record type='price'>Most Valuable Car at $15 million</record>
</car>
</records>
'''
}
```

Here is an example of using [DOM4J](#) with Groovy to process an existing XML file:

```
// require(groupId:'dom4j', artifactId:'dom4j', version:'1.6.1')
import org.dom4j.io.SAXReader

def reader = new StringReader(XmlExamples.CAR_RECORDS)
def records = new SAXReader().read(reader).rootElement
def messages = []

records.elementIterator().each{ car ->
    def make = car.attributeValue('make')
    def country = car.elementText('country')
    def type = car.element('record').attributeValue('type')
    messages << make + ' of ' + country + ' has a ' + type + ' record'
}

assert messages == [
    'Holden of Australia has a speed record',
    'Peel of Isle of Man has a size record',
    'Bugatti of France has a price record'
]
```

DOM4J also supports a streaming mode which lets you manually prune parts of the DOM tree during processing to facilitate processing large documents. Here is an example which uses DOM4J in that mode:

```
// require(groupId:'dom4j', artifactId:'dom4j', version:'1.6.1')
import org.dom4j.io.SAXReader
import org.dom4j.*

class PruningCarHandler implements ElementHandler {
    def messages = []
    public void onStart(ElementPath path) { }
    public void onEnd(ElementPath path) {
        def car = path.current
        def make = car.attributeValue('make')
        def country = car.elementText('country')
        def type = car.element('record').attributeValue('type')
        messages << make + ' of ' + country + ' has a ' + type + ' record'
        car.detach() // prune the tree
    }
}
```

```
}

def xml      = new StringReader(XmlExamples.CAR_RECORDS)
def reader  = new SAXReader()
def handler = new PruningCarHandler()

reader.addHandler('/records/car', handler)
reader.read(xml)

assert handler.messages == [
  'Holden of Australia has a speed record',
  'Peel of Isle of Man has a size record',
  'Bugatti of France has a price record'
]
```

In the above example, we actually did the processing as part of the `ElementHandler`. Instead, we could have used a hybrid approach which just pruned away parts of the tree we weren't interested in and then performed tree-walking/navigation style coding after that.

Reading XML with Groovy and JDOM

This page last changed on Sep 25, 2007 by [tomstrummer](#).

This example assumes the following class is already on your CLASSPATH:

XmlExamples.groovy

```
class XmlExamples {
    static def CAR_RECORDS = '''
    <records>
    <car name='HSV Maloo' make='Holden' year='2006'>
    <country>Australia</country>
    <record type='speed'>Production Pickup Truck with speed of 271kph</record>
    </car>
    <car name='P50' make='Peel' year='1962'>
    <country>Isle of Man</country>
    <record type='size'>Smallest Street-Legal Car at 99cm wide and 59 kg in weight</record>
    </car>
    <car name='Royale' make='Bugatti' year='1931'>
    <country>France</country>
    <record type='price'>Most Valuable Car at $15 million</record>
    </car>
    </records>
    '''
}
```

Here is an example of using [JDOM](#) with Groovy to process an existing XML file:

```
// require(groupId:'jdom', artifactId:'jdom', version:'1.0')
import org.jdom.input.SAXBuilder

def reader    = new StringReader(XmlExamples.CAR_RECORDS)
def records  = new SAXBuilder().build(reader).rootElement
def messages = []

records.children.iterator().each{ car ->
    def make = car.getAttribute('make').value
    def country = car.getChildText('country')
    def type = car.getChild('record').getAttribute('type').value
    messages << make + ' of ' + country + ' has a ' + type + ' record'
}

assert messages == [
    'Holden of Australia has a speed record',
    'Peel of Isle of Man has a size record',
    'Bugatti of France has a price record'
]
```

Reading XML with Groovy and XOM

This page last changed on Sep 25, 2007 by [tomstrummer](#).

This example assumes the following class is already on your CLASSPATH:

XmlExamples.groovy

```
class XmlExamples {
    static def CAR_RECORDS = '''
    <records>
    <car name='HSV Maloo' make='Holden' year='2006'>
    <country>Australia</country>
    <record type='speed'>Production Pickup Truck with speed of 271kph</record>
    </car>
    <car name='P50' make='Peel' year='1962'>
    <country>Isle of Man</country>
    <record type='size'>Smallest Street-Legal Car at 99cm wide and 59 kg in weight</record>
    </car>
    <car name='Royale' make='Bugatti' year='1931'>
    <country>France</country>
    <record type='price'>Most Valuable Car at $15 million</record>
    </car>
    </records>
    '''
}
```

Here is an example of using [XOM](#) with Groovy to process an existing XML file:

```
// require(groupId:'xom', artifactId:'xom', version:'1.1')
import nu.xom.Builder

def reader = new StringReader(XmlExamples.CAR_RECORDS)
def records = new Builder().build(reader).rootElement
messages = []

def processCar(car) {
    def make = car.getAttribute('make').value
    def country = car.getFirstChildElement('country').value
    def type = car.getFirstChildElement('record').getAttribute('type').value
    messages << make + ' of ' + country + ' has a ' + type + ' record'
}

def cars = records.childElements
(0..<cars.size()).each{ processCar(cars.get(it)) }

assert messages == [
    'Holden of Australia has a speed record',
    'Peel of Isle of Man has a size record',
    'Bugatti of France has a price record'
]
```

Validating XML with a DTD

This page last changed on May 26, 2007 by [paulk_asert](#).

Many XML parsers have switches to turn on DTD validation.

Suppose we have the following XML:

```
def xml = '''
<!DOCTYPE records [
<!ELEMENT car (country,record)>
<!ATTLIST car
make NMTOKEN #REQUIRED
name CDATA #REQUIRED
year NMTOKEN #REQUIRED
>
<!ELEMENT country (#PCDATA)>
<!ELEMENT record (#PCDATA)>
<!ATTLIST record type NMTOKEN #REQUIRED>
<!ELEMENT records (car+)>
]>
<records>
<car name="HSV Maloo" make="Holden" year="2006">
<country>Australia</country>
<record type="speed">Production Pickup Truck with speed of 271kph</record>
</car>
<car name="P50" make="Peel" year="1962">
<country>Isle of Man</country>
<record type="size">Smallest Street-Legal Car at 99cm wide and 59 kg in weight</record>
</car>
<car name="Royale" make="Bugatti" year="1931">
<country>France</country>
<record type="price">Most Valuable Car at $15 million</record>
</car>
</records>
'''
```

We can parse this document with validation turned on using the `XmlParser` as follows:

```
def validating = true // default is false
def namespaceAware = false // default is true
new XmlParser(validating, namespaceAware).parseText(xml)
```

Or using the `XmlSlurper` as follows:

```
new XmlParser(validating, namespaceAware).parseText(xml)
```

Or using the `DOMBuilder` as follows:

```
groovy.xml.DOMBuilder.parse(new StringReader(xml), validating, namespaceAware)
```

Validating XML with a W3C XML Schema

This page last changed on May 26, 2007 by [paulk_asert](#).

This example assumes the following class is already on your CLASSPATH:

XmlExamples.groovy

```
class XmlExamples {
    static def CAR_RECORDS = '''
    <records>
    <car name='HSV Maloo' make='Holden' year='2006'>
    <country>Australia</country>
    <record type='speed'>Production Pickup Truck with speed of 271kph</record>
    </car>
    <car name='P50' make='Peel' year='1962'>
    <country>Isle of Man</country>
    <record type='size'>Smallest Street-Legal Car at 99cm wide and 59 kg in weight</record>
    </car>
    <car name='Royale' make='Bugatti' year='1931'>
    <country>France</country>
    <record type='price'>Most Valuable Car at $15 million</record>
    </car>
    </records>
    '''
}
```

We can validate that segment of XML against a Schema with the following code:

```
def xsd = '''
<xs:schema xmlns:xs="http://www.w3.org/2001/XMLSchema" elementFormDefault="qualified">
<xs:element name="records">
<xs:complexType>
<xs:sequence>
<xs:element maxOccurs="unbounded" ref="car"/>
</xs:sequence>
</xs:complexType>
</xs:element>
<xs:element name="car">
<xs:complexType>
<xs:sequence>
<xs:element ref="country"/>
<xs:element ref="record"/>
</xs:sequence>
<xs:attribute name="make" use="required" type="xs:NCName"/>
<xs:attribute name="name" use="required"/>
<xs:attribute name="year" use="required" type="xs:integer"/>
</xs:complexType>
</xs:element>
<xs:element name="country" type="xs:string"/>
<xs:element name="record">
<xs:complexType mixed="true">
<xs:attribute name="type" use="required" type="xs:NCName"/>
</xs:complexType>
</xs:element>
</xs:schema>
'''

import javax.xml.XMLConstants
import javax.xml.transform.stream.StreamSource
import javax.xml.validation.SchemaFactory

def factory = SchemaFactory.newInstance(XMLConstants.W3C_XML_SCHEMA_NS_URI)
def schema = factory.newSchema(new StreamSource(new StringReader(xsd)))
def validator = schema.newValidator()
validator.validate(new StreamSource(new StringReader(XmlExamples.CAR_RECORDS)))
```

Validating XML with RELAX NG

This page last changed on May 26, 2007 by [paulk_asert](#).

This example assumes the following class is already on your CLASSPATH:

XmlExamples.groovy

```
class XmlExamples {
    static def CAR_RECORDS = '''
<records>
<car name='HSV Maloo' make='Holden' year='2006'>
<country>Australia</country>
<record type='speed'>Production Pickup Truck with speed of 271kph</record>
</car>
<car name='P50' make='Peel' year='1962'>
<country>Isle of Man</country>
<record type='size'>Smallest Street-Legal Car at 99cm wide and 59 kg in weight</record>
</car>
<car name='Royale' make='Bugatti' year='1931'>
<country>France</country>
<record type='price'>Most Valuable Car at $15 million</record>
</car>
</records>
'''
}
```

A number of [RELAX NG](#) validators are available (e.g. [MSV](#) and [Jing](#)). Rather than using the APIs for these validators directly, you might want to consider using the [ISO RELAX](#) project's common JARV API for accessing validators. Using this common API, you can switch between the [available validators](#) without changing your source code.

An even better option (if you are using Java 5 or above, or otherwise have JAXP 1.3 available to you) is to use the [ISORELAX JARV to JAXP 1.3 Xml Validation Engine Adaptor](#). This hooks into the built-in JAXP validation Factory support in JAXP and makes the code that you use to access the RELAX NG validator the same as you would do for a W3C XML Schema validator.

Here is what the code would look like:

```
// require(url:'http://iso-relax.sourceforge.net/', jar:'isorelax.jar')
// require(groupId:'org.iso-relax.verifier.jaxp.validation', artifactId:'isorelax-jaxp-bridge',
version:'1.0')
// require(url:'https://msv.dev.java.net/', jar:'msv.jar')

def rng = '''
<grammar xmlns="http://relaxng.org/ns/structure/1.0"
datatypeLibrary="http://www.w3.org/2001/XMLSchema-datatypes">
<start>
<ref name="records"/>
</start>
<define name="car">
<element name="car">
<attribute name="make">
<data type="token"/>
</attribute>
<attribute name="name">
<text/>
</attribute>
<attribute name="year">
<data type="integer"/>
</attribute>
<ref name="country"/>
<ref name="record"/>
</element>
</define>
<define name="country">
<element name="country">
```

```

<text/>
</element>
</define>
<define name="record">
<element name="record">
<attribute name="type">
<data type="token"/>
</attribute>
<text/>
</element>
</define>
<define name="records">
<element name="records">
<oneOrMore>
<ref name="car"/>
</oneOrMore>
</element>
</define>
</grammar>
''.trim()

import javax.xml.XMLConstants
import javax.xml.transform.stream.StreamSource
import javax.xml.validation.SchemaFactory

def factory = SchemaFactory.newInstance(XMLConstants.RELAXNG_NS_URI)
def schema = factory.newSchema(new StreamSource(new StringReader(rng)))
def validator = schema.newValidator()
validator.validate(new StreamSource(new StringReader(XmlExamples.CAR_RECORDS)))

```

XML Example

This page last changed on Oct 04, 2006 by [paulk_asert](#).

XmlExamples.groovy

```
class XmlExamples {
static def CAR_RECORDS = '''
<records>
<car name='HSV Maloo' make='Holden' year='2006'>
<country>Australia</country>
<record type='speed'>Production Pickup Truck with speed of 271kph</record>
</car>
<car name='P50' make='Peel' year='1962'>
<country>Isle of Man</country>
<record type='size'>Smallest Street-Legal Car at 99cm wide and 59 kg in weight</record>
</car>
<car name='Royale' make='Bugatti' year='1931'>
<country>France</country>
<record type='price'>Most Valuable Car at $15 million</record>
</car>
</records>
'''
}
```

Regular Expressions

This page last changed on Dec 23, 2006 by [paulk_asert](#).

Groovy supports regular expressions natively using the `~"pattern"` expression, which compiles a Java Pattern object from the given pattern string. Groovy also supports the `==~` (create Matcher) and `==~` (matches regex) operators.

For matchers having groups, `matcher[index]` is either a matched String or a List of matched group Strings, since jsr-03 release.

```
import java.util.regex.Matcher
import java.util.regex.Pattern

assert "cheesecheese" ==~ "cheese"
assert "cheesecheese" ==~ /cheese/
assert "cheese" == /cheese/ /*they are both string syntaxes*/

// lets create a regex Pattern
def pattern = ~/foo/
assert pattern instanceof Pattern
assert pattern.matcher("foo").matches()

// lets create a Matcher
def matcher = "cheesecheese" ==~ /cheese/
assert matcher instanceof Matcher
answer = matcher.replaceAll("edam")

// lets do some replacement
def cheese = ("cheesecheese" ==~ /cheese/).replaceFirst("nice")
assert cheese == "nicecheese"

// simple group demo
// You can also match a pattern that includes groups. First create a matcher object, either
// using the Java API, or more simply with the ==~ operator. Then, you can index the matcher
// object to find the matches. matcher[0][1] means the 0th match of the whole pattern (with the
// ==~ operator the pattern may match the string in more than one place), and the 1st group within
// that match. Here's how it works:
def m = "foobarfoo" ==~ /o(b.*r)f/
assert m[0][1] == "bar"

// fancier group demo
matcher = "\$abc." ==~ "\\\$(.*)\\"
matcher.matches(); // must be invoked [Question: is this still true? Not in my experience with
jsr-04.]
assert matcher.group(1) == "abc" // is one, not zero
// assert matcher[1] == "abc" // This has worked before jsr-03-release
assert matcher[0] == ["\$abc.", "abc"] // But this should work since jsr-03-release
assert matcher[0][1] == "abc" // This should work since jsr-03-release
```

The pattern can be expressed more simply using the `/` delimiter for the pattern, so we don't have to double all the backslashes.

```
def matcher = "\$abc." ==~ /\$(.*)\./ // no need to double-escape!
assert "\\\$(.*)\\" == /\$(.*)\./
matcher.matches(); // must be invoked
assert matcher.group(1) == "abc" // is one, not zero
// assert matcher[1] == "abc" // This has worked before jsr-03-release
assert matcher[0] == ["\$abc.", "abc"] // But this should work since jsr-03-release
assert matcher[0][1] == "abc" // This should work since jsr-03-release
```

Since a Matcher coerces to a boolean by calling its **find** method, the `==~` operator is consistent with the simple use of Perl's `==~` operator, when it appears as a predicate (in 'if', 'while', etc.). The "stricter-looking" `==~` operator requires an exact match of the whole subject string.

Regular expression support is imported from Java. Java's regular expression language and API is documented [here](#).

More Examples

```
def before='''
apple
orange
banana
'''

def expected='''
Apple
Orange
Banana
'''

assert expected == before.replaceAll(/(?m)^\w+/, {it[0].toUpperCase() + it[1..-1]})
```

Reserved Words

This page last changed on Nov 24, 2007 by [paulk_asert](#).

The following words are reserved in Groovy:

byte
public
case
short
break
while
new
instanceof
implements
synchronized
const
float
package
return
throw
null
def
threadsafe
protected
class
throws
do
strictfp
super
transient
native
interface
final
if
double
volatile
as
assert
catch
try
goto
enum
int
for
extends
boolean
char
private
default
false
this
static
abstract
continue
finally
else
import
in
void
switch
true
long

Modifiers

The following words (included in the full list above) can be used as modifiers:

`private, public, protected, static, transient, final,
abstract, native, threadsafe, synchronized, volatile, strictfp`

This is the same as in Java.

Type declarations

The following words (included in the full list above) can be used to start type declarations:

`class, interface, enum`

Property names

The following reserved words (included in the full list above) are allowed as property names:

`class, in, as, def, default, static, goto, if, else,
for, while, do, switch, try, catch, finally`

Running Groovy on .NET 2.0 using IKVM

This page last changed on Dec 10, 2007 by chanwit@gmail.com.

Overview

It is possible to run Groovy on .NET 2.0 using IKVM as a virtual machine. By using IKVM compiler, you can compile your Groovy jar to be a .NET assembly (a DLL file) with the following command:

```
ikvmc -target:library groovy-all-1.5.0.jar
```

However, some warning will appear, but you can ignore them. After compilation you should have **groovy-all-1.5.0.dll** in the current directory.

Using the Groovy .NET Assembly

With the compiled DLL, you can use it as a normal .NET assembly. The following example shows how to add it as a reference for building a simple application. You need the [SharpDevelop](#) IDE in this case.

- Open SharpDevelop, create a new .NET console application.
- Add references, your groovy DLL, and all IKVM DLLs.
- Open your main class, type the following code (in C# for example)

```
using System;
using System.Collections.Generic;

namespace GroovyDotNet {
class MainClass {
public static void Main(string[] args) {
groovy.ui.InteractiveShell.main(args);
}
}
}
```

- Run the program, and you'll also have an executable file as well (in ./Debug directory).

the original post:

<http://chanwit.blogspot.com/2007/04/groovy-running-fine-on-net.html>

Invoking .NET classes

We can call .NET classes directly from Groovy scripts. Note that IKVM has the **cli** prefix for all .NET namespaces. If you want to invoke **Console.WriteLine('hello world')**, you have to type:

```
cli.System.Console.WriteLine('hello world')
```

The great thing here is that Groovy can pick a correct .NET method. You can also try:

```
cli.System.Console.WriteLine('hello world {0}', 'from Groovy')
```

in the interactive console (the binary in the attachment of this page).

Encoding Issues

On some machines, there will be a test encoding issue to stop Groovy compiling script files. This seems to be the use of different encoding names between Java and .NET. If you find this kind of error, try specifying "-c" when testing with groovy.ui.GroovyMain class.

Further development as a Groovy module?

Discuss [here](#).

Scoping and the Semantics of "def"

This page last changed on Mar 31, 2007 by [paulk_asert](#).

Note: This page may not follow the explanations from the JLS.

Java has two basic informal rules for scoping:

Principle #1: "A variable is only visible in the block it is defined in and in nested blocks".

Principle #2: "A variable can't be visible more than one time".

Java does know classwide variables and local variables. Local variables are defined as method parameter or inside the method block. Classwide variables are defined as attributes of the class. Of course Java does violate this first principle I showed at top here a little since I can access class wide variables from outside the class, if the access modifier is for example public. A local variable of the same name as an attribute does not violate the second principle, as the attribute is hidden by the local variable and with this no longer visible without using a qualifier like "this".

Now, what about Groovy?

In Groovy we also have these two principles, but since we have different constructs, we may lay out these principles in a different way. Let us start with local variables.

- In Groovy you are neither allowed to define two local variables of the same name, just like in Java.
- You are allowed to hide an attribute by defining a local variable of the same name, just like in Java.

So what is different?

Scripts are. When you define a variable in a script it is always local. But methods are not part of that scope. So defining a method using different variables as if they were attributes and then defining these variables normally in the script leads to problems. Example:

Example of disallowed definition in scripts

```
String attribute = "bar"
void aMethod(){
  assert attribute == "bar" // Not allowed !
}
aMethod()
```

Executing this code you get an exception talking about a missing property or field.

The only things the method has access to are:

- the binding,
 - attributes defined by the base class, and
 - the dynamic properties defined by the MetaClass (explanations for these will follow).
- "attribute" here is no field, no property, no dynamic defined property and not part of the binding.

When is something in the Binding and when not?

That's easy. When it is not defined, it is in the binding.

```
String localVar = "I am a local variable"
bindingVar = "I am a binding variable"
```

The trick is - and that is admittedly not easy for Java programmers - to **not** to define the variable before using it, and it will go into the binding. Any defined variable is local. **Please note: the binding exists only for scripts.**

What is this "def" I heard of?

"def" is a replacement for a type name. In variable definitions it is used to indicate that you don't care about the type. In variable definitions it is mandatory to either provide a type name explicitly or to use "def" in replacement. This is needed to make variable definitions detectable for the Groovy parser.

These definitions may occur for local variables in a script or for local variables and properties/fields in a class.



Rule of thumb

You can think of "def" as an alias of "Object" and you will understand it in an instant.

Future Groovy may give "def" an additional meaning in terms of static and dynamic typing. But this is post Groovy 1.0.

"def" can also replace "void" as the return type in a method definition.

```
def dynamic = 1
dynamic = "I am a String stored in a variable of dynamic type"
int typed = 2
typed = "I am a String stored in a variable of type int??" // throws ClassCastException
```

The assignment of a string, to a variable of type int will fail. A variable typed with "def" allows this.

A Closure is a block

In the terms of the principles above a closure is a block. A variable defined in a block is visible in that block and all blocks that are defined in that block. For example in Java:

a Java block

```
{
int i=1;
{
System.out.println (i);
}
}
```

Such a block may be defined freely as in the example above, or by loops, synchronized statements, try-catch, switch, ... all that has "{".

In Groovy we have an additional structure with "{", the closure. To follow the principles above, it is not allowed to define two variables of the same name in a closure.

Not allowed

```
def closure = { int i; int i }
```

And of course, the same for combinations with nested closures.

invalid double definition of variables

```
def outer = {
int i
def inner = { int i }
}
```

A block ends with its corresponding "}". So it is allowed to reuse that name later in a different block.

Allowed

```
def closure1 = { parameter ->
println parameter
}
def closure2 = { parameter ->
println parameter
}
```

```
}
```

Both closures define a local variable named "parameter", but since these closures are not nested, this is allowed. **Note: unlike early versions of Groovy and unlike PHP, a variable is visible in the block, not outside. Just like in Java.**

And "it"?

"it" is a special variable name, that is defined automatically inside a closure. It refers always to the first parameter of the closure, or null, if the closure doesn't have any parameters.

implicit it in closures

```
def c = { it }
assert c() == null
assert c(1) == 1
```

When using nested closures (closures in closures) the meaning of "it" depends on the closure you are in.

```
def outer = {
def inner = { it+1 }
inner(it+1)
}
assert outer(1) == 3
```

You see, that "it" is used two times, the "it" in "inner" means the first parameter of the closure "inner", the following "it" means the first parameter of "outer". This helps a lot when copying code from one place to another containing closure that are using it.

The keyword "static"

"static" is a modifier for attributes (and methods, but this is not at issue here). It defines the "static scope". That means all variables not defined with "static" are not part of that static scope and as such not visible there. There is no special magic to this in Groovy. So for an explanation of "static" use any Java book.

Scripts and Classes

This page last changed on Jan 18, 2008 by [standtrooper](#).

Classes are defined in Groovy similarly to Java. Methods can be class (static) or instance based and can be public, protected, private and support all the usual Java modifiers like synchronized. Package and class imports use the Java syntax (including static imports). Groovy automatically imports the following:

- java.lang
- java.io
- java.math
- java.net
- java.util
- groovy.lang
- groovy.util

One difference between Java and Groovy is that by default things are public unless you specify otherwise.

Groovy also merges the idea of fields and properties together to make code simpler, please refer to the [Groovy Beans](#) section for details of how they work.

Each class in Groovy is a Java class at the bytecode / JVM level. Any methods declared will be available to Java and vice versa. You can specify the types of parameters or return types on methods so that they work nicely in normal Java code. Also you can implement interfaces or overload Java methods using this approach.

If you omit the types of any methods or properties they will default to java.lang.Object at the bytecode/ JVM level.

You can also use another class implemented in Groovy. e.g.

```
//Callee.groovy
class Callee {
void hello() {
println "hello, world"
}
}
```

```
//Caller.groovy
c = new Callee()
c.hello()
```

```
groovy -cp . caller
```

Make sure the classpath is OK.

Scripts

Groovy supports plain scripts, which do not have a class declaration. Imports are supported at the front of a script in the same way that they can be at the front of a class. Here's the hello world script:

```
println "Nice cheese Gromit!"
```

You can [run](#) scripts in the [interactive terminal](#), from the [command-line](#), in your [IDE](#), as a [Unix script](#), or [embed](#) in your own Java code.

If you compile the above script to bytecode using [groovyc](#), you get a single class named after the name of the script. e.g. if this was saved in Foo.script you'd get a Foo.class file.

You can run this Java code on the command line (assuming you're classpath has groovy.jar and asm.jar).

```
java Foo
```

This will execute the autogenerated main(String[] args) method in the bytecode which instantiates the Foo class, which extends the

[Script](#) class and then call its *run()* method. You may also use this class directly in Java code, passing in variables to the script.

```

import groovy.lang.Binding;
import groovy.lang.Script;

public class UseFoo {
public static void main(String[] args) {
// lets pass in some variables
Binding binding = new Binding();
binding.setVariable("cheese", "Cheddar")
binding.setVariable("args", args)

Script foo = new Foo(binding);
foo.run();
}
}

```

There's no need to use a Binding if you don't want to; Foo will have a no-argument constructor as well. Though using a Binding you can easily pass in variables. After the end of the script any variables created will be in the Binding for you to access in Java.

Unlike classes, variables are not required to be declared (*def* is not required) in scripts. Variables referenced in a script are automatically created and put into the Binding.

Scripts and functions

If you just want to write some simple scripts and need some simple functions you can declare functions without writing a class.

One difference from normal class-based groovy is that the *def* keyword is required to define a function outside of a class.

Here's an example of a simple script with a function. Note that if ever you need things like static or instance variables and so forth then maybe its time to actually write a class 😊

```

def foo(list, value) {
println "Calling function foo() with param ${value}"
list << value
}

x = []
foo(x, 1)
foo(x, 2)
assert x == [1, 2]

println "Creating list ${x}"

```

Statements

This page last changed on Sep 14, 2007 by [glaforge](#).

Groovy uses a similar syntax to Java although in Groovy semicolons are optional. This saves a little typing but also makes code look much cleaner (surprisingly so for such a minor change). So normally if one statement is on each line you can omit semicolons altogether - though its no problem to use them if you want to. If you want to put multiple statements on a line use a semicolon to separate the statements.

```
def x = [1, 2, 3]
println x
def y = 5; def x = y + 7
println x
assert x == 12
```

If the end of the line is reached and the current statement is not yet complete it can be spanned across multiple lines. So for things like method parameters or creating lists or for complex if expressions you can span multiple lines.

```
def x = [1, 2, 3,
4, 5, 6]
println(
x
)
if (x != null &&
x.size() > 5) {
println("Works!")
}
else {
assert false: "should never happen ${x}"
}
```

Comments

The characters `"/"` begin a comment that last for the rest of the line.

```
print "hello" // This is a silly print statement
```

The characters `"/"` **begin a comment that lasts until the first `"/"`.**

```
/* This is a long comment
about our favorite println */
println "hello"
```

The character `"#"` is not a comment character.

```
// This doesn't work:
# Bad comment
```

Method calls

Method calling syntax is similar to Java where methods can be called on an object (using dot) or a method on the current class can be called. Static and instance methods are supported.

```
class Foo {
def calculatePrice() {
1.23
}

static void main(args) {
def foo = new Foo()
def p = foo.calculatePrice()
assert p > 0
}
```

```
println "Found price: " + p
}
}
```

Notice that the *return* statement is optional at the end of methods. Also you don't need to specify a return type (it will default to Object in the bytecode if none is specified).

Optional parenthesis

Method calls in Groovy can omit the parenthesis if there is at least one parameter and there is no ambiguity.

```
println "Hello world"
System.out.println "Nice cheese Gromit!"
```

It is also possible to omit parenthesis when using named arguments. This makes for nicer DSLs:

```
compare fund: "SuperInvestment", withBench: "NIKEI"
monster.move from: [3,4], to: [4,5]
```

Named parameter passing

When calling a method you can pass in named parameters. Parameter names and values are separated by a colon (like the Map syntax) though the parameter names are identifiers rather than Strings.

Currently this kind of method passing is only implemented for calling methods which take a Map or for constructing JavaBeans.

```
def bean = new Expando(name:"James", location:"London", id:123)
println "Hey " + bean.name
assert bean.id == 123
```

Passing closures into methods

Closures are described in more detail [here](#). Closures can be passed into methods like any other object

```
def closure = { param -> param + 1 }
def answer = [1, 2].collect(closure)
assert answer == [2, 3]
```

Though there is some syntax sugar to make calling methods which take a closure easier. Instead of specifying parenthesis, you can just specify a closure. e.g.

```
answer = [1, 2].collect { param -> param + 1 }
assert answer == [2, 3]
```

The above code is equivalent to the previous code, just a little more groovy. If a method takes parameters you can leave the closure outside of the parenthesis (provided that the closure parameter is the last parameter on the underlying method).

```
def value = [1, 2, 3].inject(0) { count, item -> count + item }
assert value == 6
```

The above code is equivalent to the following (but just neater)

```
def value = [1, 2, 3].inject(0, { count, item -> count + item })
assert value == 6
```

Important Note

Note that when using the neater syntax for specifying closures either without parenthesis or by specifying the closure after the parenthesis, the closure must start on the same line. i.e. the { symbol must be on the same line as the method call statement. Otherwise the parser interprets the { as a start of a block.

Dynamic method dispatch

If a variable is not constrained by a type then dynamic method dispatch is used. This is often referred to as *dynamic typing* whereas Java uses *static typing* by default. You can mix and match both dynamic and static typing in your code by just adding or removing types. e.g.

```
def dynamicObject = "hello world".replaceAll("world", "Gromit")
dynamicObject += "!"
assert dynamicObject == "hello Gromit!"
String staticObject = "hello there"
staticObject += "!"
assert staticObject == "hello there!"
```

Properties

These are described in more detail in the [Groovy Beans](#) section. To access properties you use dot with the property name. e.g.

```
def bean = new Expando(name:"James", location:"London", id:123)
def name = bean.name
println("Hey ${name}")
bean.location = "Vegas"
println bean.name + " is now in " + bean.location
assert bean.location == "Vegas"
```

The above uses a special bean called Expando which allows properties to be added dynamically at runtime.

An Expando is a Map which behaves as a dynamic bean: adding new key/value pairs add the equivalent getter and setter methods, as if they were defined in a real bean.

Safe navigation

If you are walking a complex object graph and don't want to have NullPointerExceptions thrown you can use the ?. operator rather than . to perform your navigation.

```
def foo = null
def bar = foo?.something?.myMethod()
assert bar == null
```

Static Import Usage

This page last changed on Jun 18, 2007 by [paulk_asert](#).

Groovy's *static import* capability allows you to reference imported classes as if they were static methods in your own class. This is similar to Java's *static import* capability but works with Java 1.4 and above and is a little more dynamic than Java in that it allows you to define methods with the same name as an imported method as long as you have different types. If you have the same types, the imported class takes precedence. Here is a sample of its usage:

```
import static java.awt.Color.LIGHT_GRAY
import static Boolean.FALSE as F
import static Calendar.getInstance as now
import static Integer.*

println LIGHT_GRAY
// => java.awt.Color[r=192,g=192,b=192]

println !F
// => true

println now().time
// => Sun Apr 29 11:12:43 EST 2007

println "Integers are between $MIN_VALUE and $MAX_VALUE"
// => Integers are between -2147483648 and 2147483647

def toHexString(int val, boolean upperCase) {
def hexval = upperCase ? toHexString(val).toUpperCase() : toHexString(val)
return '0x' + hexval
}
println toHexString(15, true)
// => 0xF
println toHexString(15, false)
// => 0xf
```

The first static import illustrates defining `LIGHT_GRAY` as if it was defined locally as a static field. The next two examples show renaming (called *aliasing*) of a field and a method respectively. The final example illustrates wild-carding for fields and methods and also selecting between the locally defined `toHexString` and imported `toHexString` based on parameter matching.

As another example, here is how to statically import some of the Math functions:

```
import static Math.*
println sin(123.456) * cos(456.789)
// => 0.24733809349262376
```

Strings

This page last changed on Apr 17, 2008 by [paulk_asert](#).

Groovy uses both " and ' for strings. Either can be used. Using either type of string allows you to use strings with quotations easily.

```
println "he said 'cheese' once"
println 'he said "cheese!" again'
```

The groovy parser supports the notation `\uab12` (i.e. a leading backslash and precisely four hex digits after the 'u').

This notation can be used in strings or anywhere in the program like the Java parser does.

Concatenation

Strings may be concatenated with "+". For example:

```
#!/usr/bin/env groovy

a = "world"
print "hello " + a + "\n"
```

Multi-line strings

Regular strings in Groovy cannot span multiple lines.

As an exception to this rule, a backslash at the end of a line disappears and joins the current line with the next.

```
// this is a compile error
def foo = "hello
```

If you have a block of text which you wish to use but don't want to have to encode it all (e.g. if its a block of HTML or something) then you can use the `"""` syntax.

```
def name = "James"
def text = """\
hello there ${name}
how are you today?
"""\

assert text != null
println(text)
```

Because of the leading backslash, the string `text` contains exactly two newlines. There are always represented by the character `'\n'`, regardless of the line-termination conventions of the host system.

Slashy String literals

It is possible to use the another notation for String literals with the added benefit of not needing additional backslashes to escape special characters. That is especially handy with regular expressions or Windows file/directory path names.

```
def s = /.foo./
def dirname = /^..*\//
def basename = /[^\./]+$/
```

The only escape that is supported in a slashy string is to use `\/` to embed a slash into the string. A consequence of this is that you can't have a backslash as the last character of a slashy string directly (or Groovy will think you are trying to escape the closing string terminator - and hence won't think you have

terminated your string). Instead use: `def bs = '\\\\'; def winpath=/C:\windows\system32$bs/` or `def winpath=/C:\windows\system32\${}/`.

Another gotcha: don't try using an empty slashy string: `def x = //`, the slashes will be treated as a line comment delimiter, but `def z = /${}/` would be fine.

A final gotcha: currently a slashy string can't be the left hand side (LHS) expression of an `assert` statement while you are eliminating the brackets, e.g.:

```
assert 'ab' == 'a' + 'b'    // OK, no slashy string
assert 'a' + 'b' == /ab/   // OK, slashy string on RHS
assert (/ab/ == 'a' + 'b') // brackets currently required if slashy string is on LHS
```

This is a feature of the current grammar rather than a desired goal and may one day be altered to remove this anomaly - it is a tricky edge case in the grammar.

For more examples, read about [Regular Expressions](#).

Strings are immutable

This can be seen with these two code snips, which you can cut and paste into groovyConsole:

```
st = ["status":"test"]
sn = st
println sn
st.status = "tset"
println sn
```

Above both variables are references to the map.

If you do the same thing with Strings, the behavior is different:

```
st = "test"
sn = st
println sn
st = "tset"
println sn
```

Here is the explanation by Guillaume Laforge:

`sn` and `st` point at the very same map object in memory in the first example, while in the second snippet, at the end, `st` points at a different place in memory where there's the new immutable string.

GStrings

Strings that are declared inside double-quotes (i.e. either single double-quotes or triple double-quotes for multi-line strings) can contain arbitrary expressions inside them as shown above using the `${expression}` syntax in a similar way to JSP EL, Velocity and Jexl. Any valid Groovy expression can be enclosed in the `${...}` including method calls etc. GStrings are defined the same way as normal Strings would be created in Java. Here is a simple example involving a simple variable and an expression:

```
foxytype = 'quick'
foxcolor = ['b', 'r', 'o', 'w', 'n']
println "The $foxytype ${foxcolor.join()} fox"
// => The quick brown fox
```

What actually happens is whenever a string expression contains a `${...}` expression then rather than a normal `java.lang.String` instance, a [GString](#) object is created which contains the text and values used inside the String.

GString can involve lazy evaluation so it's not until the `toString()` method is invoked that the GString is evaluated. This lazy evaluation is useful for things like logging as it allows the calculation of the string, the calls to `toString()` on the values, and the concatenation of the different strings to be done lazily if at all. Here is an example that illustrates lazy evaluation:

```
println new Date()
x = "It is currently ${ new Date() }"
y = "It is currently ${ writer -> writer << new Date() }"
sleep 5000
println x
println y
```

which outputs the following:

```
Thu Apr 17 23:18:17 EST 2008
It is currently Thu Apr 17 23:18:17 EST 2008
It is currently Thu Apr 17 23:18:22 EST 2008
```

To explain this output, we need to understand an additional rule about GStrings that we haven't covered yet. It involves different rules for evaluating a closure expression within a GString based on the number of arguments to the closure. Here are the rules:

- If the Closure takes 0 parameters then call the Closure and use the returned value as the value at that point in the GString
- If the Closure takes 1 parameter then call the Closure with a Writer as the parameter and use the characters written to the Writer as the value at that point in the GString
- If the Closure takes more that one parameter throw a GroovyRuntimeException.

So, in the example above, `x` contains a 0 parameter closure which means that `new Date()` will be invoked and the value stored away as a GString value. When we attempt to print `x` later, that calculated value is placed in the appropriate place in the GString and output giving us the date at GString definition time. But, `y` contains a 1 parameter closure which means that the closure expression will be stored away in the GString. When we print out `y`, the closure will be invoked and give as the date at printing time.

Another use case for GString is [GSQL](#) where parameters can be passed into SQL statements using this same mechanism which makes for a neat way to integrate Groovy with other languages like SQL. GroovySql then converts the expressions to `?` and uses a JDBC PreparedStatement and passes the values in, preserving their types.

If you explicitly want to coerce the GString to a String you can use the `toString()` method. Groovy can also automatically coerce GStrings into Strings for you.

String and StringBuffer Methods

See: [JN1525-Strings](#).

More Examples

The following example passes the test:

```
aaa = '"bread","apple","egg"'
items = aaa.split(',')
assert items[1] == '"apple"'
items.each{ println "item: $it" }
```

and outputs:

```
item: "bread"
item: "apple"
item: "egg"
```

Things to remember

This page last changed on Apr 10, 2007 by [tomstrummer](#).

Strings

- Strings are not Lists. In the JVM `java.lang.String` does not implement `java.util.List`.
- Arrays are not Lists. In the JVM arrays and `java.util.List` are quite different. In Groovy we support both as different types to ensure we interoperate cleanly with Java code. Though we try wherever possible to make them interchangeable and appear polymorphic.

Maps

- Maps override the dot operator, so `myMap.size` will return null unless you have a value for `map[size]`. Use `map.size()` or `map.@size` instead.
- In map literals, all keys are interpreted as strings by default! If you want to use a variable or other literal as a key, use parentheses like so: `myMap = [(var1):val, (var2):val]`
- See the [Maps user guide](#)

Things you can do but better leave undone

This page last changed on Jan 09, 2008 by [gerrit](#).

Groovy is a powerful tool. Like other powerful tools (think of a chainsaw) it requires a certain amount of user expertise and attention. Otherwise, results may be fatal.

Following code fragments are allowed in Groovy but usually result in unintended behaviour or incomprehensible problems. Simply don't do this and spare yourself some of the frustration that new and unskilled Groovy programmers sometimes experience.

1. Accessing an object's type like a property

Using `.class` instead of `.getClass()` is ok - as long as you know exactly what kind of object you have. But then you don't need that at all. Otherwise, you run in the risk of getting `null` or something else, but not the class of the object.

```
a = [:]
println a.class.simpleName // NullPointerException, because a.class is null.
```

2. Omitting parentheses around method arguments when not appropriate

Better use parentheses for argument lists unless you are sure. For instance, a left parenthesis after a method name must always enclose the parameter list.

```
println a*(b+c) // is OK
println (a+b)*c // NullPointerException, because println (a+b) results in null.
```

3. Putting a newline at the wrong place into the code

This may cause the compiler to assume a complete statement although it is meant as continuing in the next line. It is not always as obvious as in the following example.

```
myVariable = "This is a very long statement continuing in the next line. Result is="
+ 42 // this line has no effect
```

4. Forgetting to write the second equals sign of the equals operator

As a result, a comparison expression turns into an assignment.

```
while (a=b) { ... } // will be executed as long as b is true (Groovy-truth)
String s = "A"; boolean b = s = "B" // b becomes true
```

(One measure is to put constant expressions in comparisons always before the equals operator.)

5. Specifying the wrong return type when overriding a method (Groovy version < 1.5.1 only)

Such a method may be considered as overloaded (a different method with the same name) and not be called as expected.

```
def toString() { ... } // does not override toString() inherited from Object
```

6. Disregarding other objects' privacy

When accessing methods, fields, or properties of other classes, make sure that you do not interfere with private or protected members. Currently Groovy doesn't distinguish properly between public, private, and protected members, so watch out yourself.

```
z = [1,2,3]
z.size = 10 // size is private; errors when trying to access z[3] to z[9], although z.size()==10

'more'.value = 'less' // results in "more"=="less"
```

7. Thoughtless dynamic programming

Check for conflicts with intended class functionality before adding or changing methods or properties using Groovy's dynamic facilities.

```
String.metaClass.class = Integer // results in 'abc'.getClass()==java.lang.Integer
```

Using Enums

This page last changed on Dec 10, 2007 by [paulk_asert](#).

Some examples (inspired by the Java Enum Tutorial):

```
enum Day {
    SUNDAY, MONDAY, TUESDAY, WEDNESDAY,
    THURSDAY, FRIDAY, SATURDAY
}

def tellItLikeItIs(Day day) {
    switch (day) {
    case Day.MONDAY:
        println "Mondays are bad."
        break
    case Day.FRIDAY:
        println "Fridays are better."
        break
    case Day.SATURDAY:
    case Day.SUNDAY:
        println "Weekends are best."
        break
    default:
        println "Midweek days are so-so."
        break
    }
}

tellItLikeItIs(Day.MONDAY)      // => Mondays are bad.
tellItLikeItIs(Day.WEDNESDAY)  // => Midweek days are so-so.
tellItLikeItIs(Day.FRIDAY)     // => Fridays are better.
tellItLikeItIs(Day.SATURDAY)   // => Weekends are best.
```

Or with a bit of refactoring, you could write the switch like this:

```
def today = Day.SATURDAY
switch (today) {
// Saturday or Sunday
case [Day.SATURDAY, Day.SUNDAY]:
    println "Weekends are cool"
    break
// a day between Monday and Friday
case Day.MONDAY..Day.FRIDAY:
    println "Boring work day"
    break
default:
    println "Are you sure this is a valid day?"
}
```

Here is a coin example:

```
enum Coin {
    penny(1), nickel(5), dime(10), quarter(25)
    Coin(int value) { this.value = value }
    private final int value
    public int value() { return value }
}

assert Coin.values().size() == 4

def pocketMoney = 2 * Coin.quarter.value() + 5 * Coin.dime.value()
assert pocketMoney == 100

// another way to do above
def coins = [Coin.quarter] * 2 + [Coin.dime] * 5
println coins // => [quarter, quarter, dime, dime, dime, dime, dime]
```

```
println coins.sum{ it.value() } // => 100
```

Here is a planet example:

```
enum Planet {
MERCURY(3.303e+23, 2.4397e6),
VENUS(4.869e+24, 6.0518e6),
EARTH(5.976e+24, 6.37814e6),
MARS(6.421e+23, 3.3972e6),
JUPITER(1.9e+27, 7.1492e7),
SATURN(5.688e+26, 6.0268e7),
URANUS(8.686e+25, 2.5559e7),
NEPTUNE(1.024e+26, 2.4746e7)
private final double mass // in kilograms
private final double radius // in metres
Planet(double mass, double radius) {
this.mass = mass
this.radius = radius
}
private double mass() { return mass }
private double radius() { return radius }
// universal gravitational constant (m3 kg-1 s-2)
public static final double G = 6.67300E-11
double surfaceGravity() { return G * mass / (radius * radius) }
double surfaceWeight(double otherMass) { return otherMass * surfaceGravity() }
}

double earthWeight = 75.0 // kg
double mass = earthWeight/Planet.EARTH.surfaceGravity()
for (p in Planet.values()) {
printf("Your weight on %s is %f%n", p, p.surfaceWeight(mass))
}

// =>
// Your weight on MERCURY is 28.331821
// Your weight on VENUS is 67.874932
// Your weight on EARTH is 75.000000
// Your weight on MARS is 28.405289
// Your weight on JUPITER is 189.791814
// Your weight on SATURN is 79.951165
// Your weight on URANUS is 67.884540
// Your weight on NEPTUNE is 85.374605
```

Note: there are currently issues with using Groovy enums in conjunction with GroovyShell. Best bet would be to check Jira if you are having problems, e.g. <http://jira.codehaus.org/browse/GROOVY-2135>

Using Spring Factories with Groovy

This page last changed on Jun 03, 2007 by [paulk_asert](#).

[Spring](#) is an open-source framework created to address the complexity of Java enterprise application development. One of Spring's goals is to help developers write simple, testable and loosely coupled systems while reducing the amount of scaffolding code required. In this respect, Groovy has a common goal. So, for simple systems, Groovy alone may be sufficient for your needs. However, as your system grows in size and complexity, and especially in hybrid Java/Groovy environments, you might find Spring's facilities provide great value to your Groovy system development.

Here we look at using Spring's Bean Factory mechanisms within Groovy. These facilities allow beans to be managed within a Spring container. The beans are normally Java objects, but since Groovy objects are Java objects, Spring can just as easily manage Groovy objects for you. In particular, in mixed Java/Groovy environments, you can leverage any existing domain objects or services already have defined in your Spring wiring from the Java part of your application. You can immediately start using those within your Groovy scripts and code, allowing a great mix of strongly-typed Java domain objects and dynamically typed Groovy code.

Let's start by exploring a simple calculator application.

Bare Bones Approach

Suppose we have the following implementation class:

```
class CalcImpl {
  def doAdd(x, y) { x + y }
}
```

We can make use of that class from a script as follows:

```
import org.springframework.beans.factory.support.*

def configure(factory) {
  def bd = new RootBeanDefinition(CalcImpl)
  factory.registerBeanDefinition('calcBean', bd)
}

def factory = new DefaultListableBeanFactory()
configure(factory)

def calc = factory.getBean('calcBean')
println calc.doAdd(3, 4) // => 7
```

This script relies on no external wiring files. Everything is configured in the script itself. If we wish to alter our system at a later time, we simply alter the configuration inside the `configure()` method. In the Java world, this wouldn't be very flexible, but in the Groovy world, this script may be executed from source code (even dynamically loaded when it changes) so altering the configuration doesn't necessarily require a new build.

Classical Spring Approach

Probably the most common way to use Spring is to use an XML *wiring* file. As systems grow larger, wiring files allow configuration to be centralised in easy to change 'groupings' of beans. Let's assume our calculator needs to eventually be expanded to have additional functionality. An approach to handling complexity as the system grows is to delegate functionality off to other components. Here is how we might code up an *adder* component:

```
class AdderImpl {
  def add(x, y) { x + y }
}
```

Then, applying the delegate design pattern we mentioned earlier would result in the following refactored calculator:

```
class CalcImpl2 {
```

```

def AdderImpl adder
def doAdd(x, y) { adder.add(x, y) }
}

```

To capture our software system configuration, we will use an XML wiring file (we have two beans):

```

<?xml version="1.0" encoding="UTF-8"?>
<beans xmlns="http://www.springframework.org/schema/beans"
xmlns:xsi="http://www.w3.org/2001/XMLSchema-instance"
xsi:schemaLocation="http://www.springframework.org/schema/beans
http://www.springframework.org/schema/beans/spring-beans.xsd">
<bean id="calcBean" class="CalcImpl2" autowire="byType"/>
<bean class="AdderImpl"/>
</beans>

```

Now, our script code looks like:

```

import org.springframework.context.support.ClassPathXmlApplicationContext

def ctx = new ClassPathXmlApplicationContext('calcbeans.xml')
def calc = ctx.getBean('calcBean')
println calc.doAdd(3, 4) // => 7

```

Annotation Approach

If we wish, we can remove the need for an XML file by using annotations. Note that we need to think carefully before using this approach extensively in a large system for two reasons. Firstly, we are more tightly coupling our system to Spring. Secondly, we are associating configuration and deployment information with our source code. Perhaps separating those concerns will have enormous benefits for large systems. The good news is that Spring lets you take on board just those annotations that you are happy to use.

Here is how we might code up our adder component:

```

import org.springframework.stereotype.Component

@Component class AdderImpl {
def add(x, y) { x + y }
}

```

Here is our modified calculator:

```

import org.springframework.beans.factory.annotation.Autowired
import org.springframework.stereotype.Component

@Component class CalcImpl3 {
@Autowired private AdderImpl adder
def doAdd(x, y) { adder.add(x, y) }
}

```

And here is our script code (note no XML file is required):

```

import org.springframework.context.support.GenericApplicationContext
import org.springframework.context.annotation.ClassPathBeanDefinitionScanner

def ctx = new GenericApplicationContext()
new ClassPathBeanDefinitionScanner(ctx).scan('') // scan root package for components
ctx.refresh()
def calc = ctx.getBean('calcImpl3')
println calc.doAdd(3, 4) // => 7

```

This example uses features in Spring 2.1 (currently at a Milestone release) and Groovy 1.1 (currently in beta release) on a Java 5 or greater JVM.

BeanBuilder Approach

We can also use the [BeanBuilder](#) from [Grails](#) to avoid writing an XML file. It will look something like this (after adding the latest Grails jar to your classpath):

```
def bb = new grails.spring.BeanBuilder()
bb.beans {
  adder(AdderImpl)
  calcBean(CalcImpl2) { delegate.adder = adder } // need to use delegate may change
}
def ctx = bb.createApplicationContext()
def calc = ctx.getBean('calcBean')
println calc.doAdd(3, 4) // => 7
```

Further Information

- The Spring Example in [Groovy and JMX](#)
- Spring [Documentation](#)

Reference

This page last changed on Dec 10, 2007 by [dserodio](#).

- [JavaDoc](#) - Groovy 1.5 API
- [GDK](#) - Groovy methods added to Java SE classes
- [Reference Card](#) (PDF)